

Use & Care Guide
Manual Del Propietario
Manuel Du Propriétaire



Vacuum Cleaner
Aspiradora
Aspirateur

Model, Modelo, Modèle
401.39000 (U.S.)

CAUTION:

Read and follow all safety and operating instructions before first use of this product.

CUIDADO:

Lea y sigue todas las instrucciones de operación y seguridad antes del uso de este producto.

ATTENTION :

Veuillez lire toutes les consignes de sécurité et le mode d'emploi avant d'utiliser ce produit.

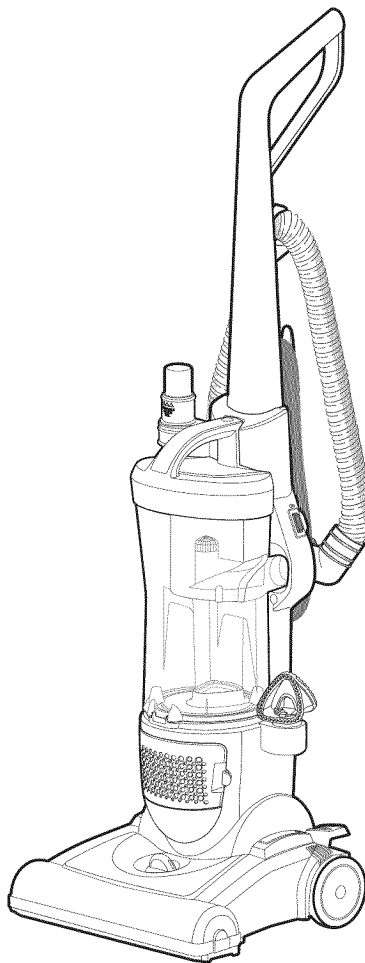

Sears, Roebuck and Co., Hoffman Estates, IL 60179 U.S.A.
www.sears.com

Printed in Korea
Impreso en Korea
Imprimé en Korea

TABLE OF CONTENTS

Before Using Your New Vacuum Cleaner2	Vacuum Cleaner Care 10-13
Kenmore Vacuum Cleaner Warranty3	Dust Bin Removal and Replacement.....10
Important Safety Instructions ... 4-5	Motor Filter Removal and Replacement.....11
Parts and Features6	Exhaust Filter Removal and Replacement.....11
Assembly Instructions 7-8	Belt or Brushroll Removal and Replacement.....12
Operating Instructions 8-9	Light Bulb Replacement.....13
Power Cord8	Troubleshooting14
Floor/ Carpet Cleaning9	Master Protection Agreements ...15
	Requesting Service(back page)

BEFORE USING YOUR NEW VACUUM CLEANER

Please read this guide. It will help you assemble and operate your new Kenmore vacuum cleaner in the safest and most effective way.

For more information about vacuum cleaner care and operation, call your nearest Sears store. You will need the complete model and serial numbers when requesting information.

Your vacuum cleaner's model and serial numbers are located on the Model and Serial Number Plate.

Use the space below to record the model number and serial number of your new Kenmore vacuum cleaner.

Model No. _____

Serial No. _____

Date of Purchase _____

Keep this book and your sales check (receipt) in a safe place for future reference.

KENMORE VACUUM CLEANER WARRANTY

ONE YEAR LIMITED WARRANTY ON KENMORE VACUUM CLEANER

When installed, operated and maintained according to all instructions supplied with the product, if this appliance fails due to a defect in material and workmanship within one year from the date of purchase, return it to any Sears store, Sears Parts & Repair Service Center, or other Kenmore outlet for free repair.

If this appliance is ever used for other than private family purposes, this warranty applies for only 90 days from the date of purchase.

**This warranty covers only defects in material and workmanship.
Sears will NOT pay for:**

1. Expendable items that can wear out from normal use, including but not limited to filters, belts, light bulbs, and bags.
2. A service technician to instruct the user in correct product installation, operation or maintenance.
3. A service technician to clean or maintain this product.
4. Damage to or failure of this product if it is not installed, operated or maintained according to the all instructions supplied with the product.
5. Damage to or failure of this product resulting from accident, abuse, misuse or use for other than its intended purpose.
6. Damage to or failure of this product caused by the use of detergents, cleaners, chemicals or utensils other than those recommended in all instructions supplied with the product.
7. Damage to or failure of parts or systems resulting from unauthorized modifications made to this product.

Disclaimer of implied warranties; limitation of remedies

Customer's sole and exclusive remedy under this limited warranty shall be product repair as provided herein. Implied warranties, including warranties of merchantability or fitness for a particular purpose, are limited to one year or the shortest period allowed by law. Sears shall not be liable for incidental or consequential damages. Some states and provinces do not allow the exclusion or limitation of incidental or consequential damages, or limitation on the duration of implied warranties of merchantability or fitness, so these exclusions or limitations may not apply to you.

This warranty applies only while this appliance is used in the United States or Canada.

This warranty gives you specific legal rights, and you may also have other rights which vary from state to state.

**Sears, Roebuck and Co., Hoffman Estates, IL 60179
Sears Canada Inc., Toronto, Ontario, Canada M5B 2B8**

IMPORTANT SAFETY INSTRUCTIONS



WARNING

Your safety is important to us. To reduce the risk of fire, electrical shock, injury to persons or damage when using your vacuum cleaner, follow basic safety precautions including the following:

READ ALL INSTRUCTIONS IN THIS MANUAL BEFORE ASSEMBLING OR USING YOUR VACUUM CLEANER.

Do not use outdoors or on wet surfaces. Electrical shock could occur.

Do not allow to be used as a toy. Close attention is necessary when used by or near children.

Use only as described in this manual. Only use attachments designed for this vacuum.

Do not use with damaged cord or plug. If appliance is not working as it should, has been dropped, damaged, left outdoors, or dropped into water, return it to a Sears or other qualified service center for inspection.

Do not pull or carry by cord, use cord as handle, close a door on a cord, or pull cord around sharp edges or corners. Do not run appliance over cord. Keep cord away from heated surfaces.

Do not unplug by pulling on cord. To unplug, grasp the plug, not the cord.

Do not leave appliance when plugged in. Unplug from outlet when not in use and before servicing.

Do not handle plug or appliance with wet hands.

Do not put any objects into openings. Do not use with any opening blocked; keep free of dust, lint, hair, and anything that may reduce air flow.

Keep hair, loose clothing, fingers, and all parts of body away from openings and moving parts.

Do not pick up anything that is burning or smoking, such as cigarettes, matches, or hot ashes.

Do not use without Dust Bin and filters in place.

Turn off all controls before unplugging.

Do not use to pick-up flammable or combustible liquids, such as gasoline, or use in areas where they may be present.

Keep the vacuum cleaner on the floor. Do not use on stairs.

Do not use an extension cord with this vacuum cleaner.

Store the vacuum cleaner indoors. Put vacuum cleaner away after use to prevent tripping accidents.

IMPORTANT SAFETY INSTRUCTIONS

Using improper voltage may result in damage to the motor and possible injury to the user. Proper voltage is listed on the cleaner plate.

WARNING : The cords, wires, and/or cables supplied with this product contains chemicals, including lead or lead compounds, known to the state of California to cause cancer and birth defects or other reproductive harm. Wash hands after using.

SAVE THESE INSTRUCTIONS

Proper assembly and safe use of your vacuum cleaner are your responsibilities. Your vacuum cleaner is intended only for **Household use**. Read this Use & Care Guide carefully for important use and safety information. This guide contains safety statements under warning and caution symbols. Please pay special attention to these boxes and follow any instructions given.

PARTS AND FEATURES

It is important to know your vacuum cleaner's parts and features to assure its proper and safe use. Review these before using your vacuum cleaner.

Item	Part No.
Headlight	DJ47-00004A
Belt	6602-001724

Accessories



Dust Brush/
Upholstery Tool

Crevice Tool



Extension
Wand

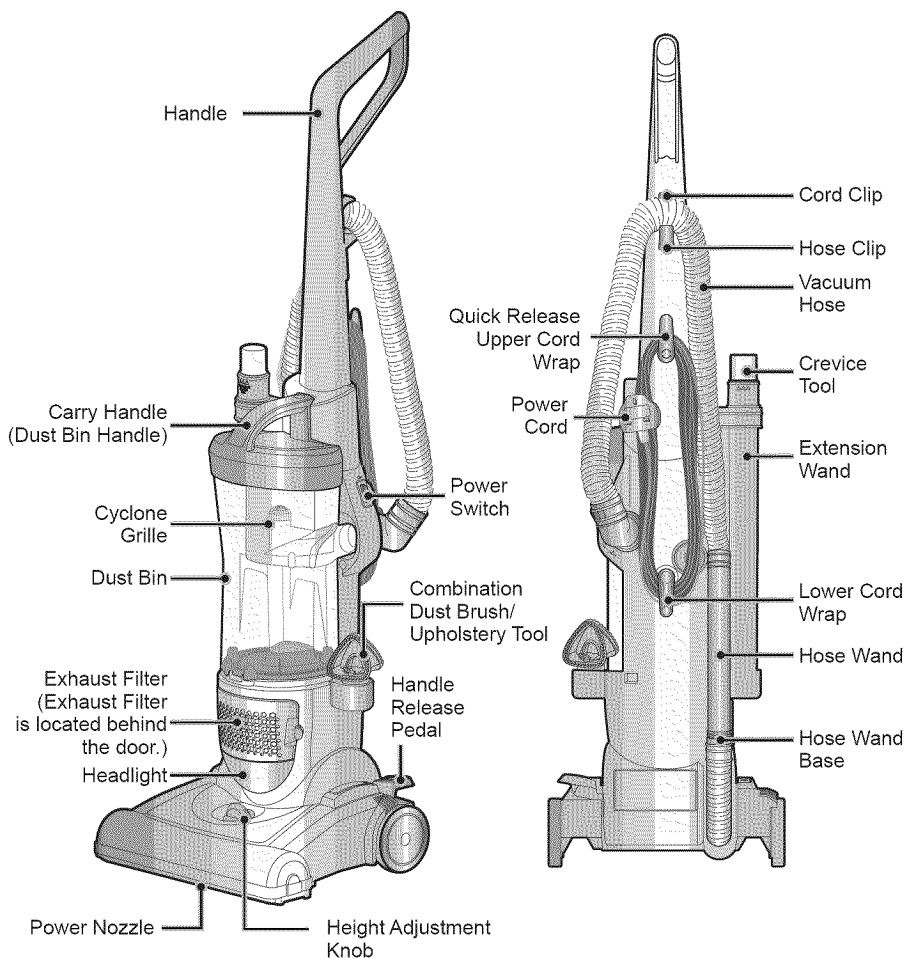



Please pay special attention to these hazard alert boxes, and follow any instructions given. **WARNING** statements alert you to such dangers as fire, electric shock, burns and personal injury. **CAUTION** statements alert you to such dangerous personal injury and/or property damage.

ASSEMBLY INSTRUCTIONS



WARNING

Electrical Shock Hazard

Do not plug into the electrical supply until the assembly is complete. Failure to do so could result in electrical shock or injury.

Before assembling the vacuum cleaner, check the **PACKING LIST** on the cover of the separate **REPAIR PARTS LIST** or on the carton. Use this list to verify that you have received all the components of your new Kenmore vacuum cleaner.

HANDLE ASSEMBLY

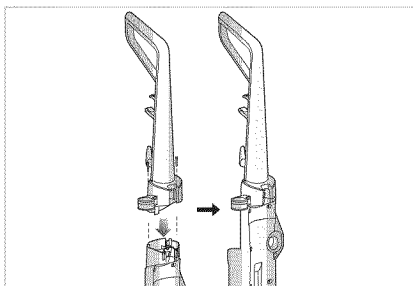

1. Stand the vacuum upright and slide the base of the handle firmly into the grooves at the top of the vacuum body.
2. Check to be sure the handle is fitted to the vacuum body. If there is a gap, continue to push firmly until the handle is flush.
3. Tighten securely with a screwdriver.



CAUTION

Do not overtighten.

Overtightening could strip the screw holes.

Do not operate the vacuum cleaner without the screws in place.

HOSE ASSEMBLY

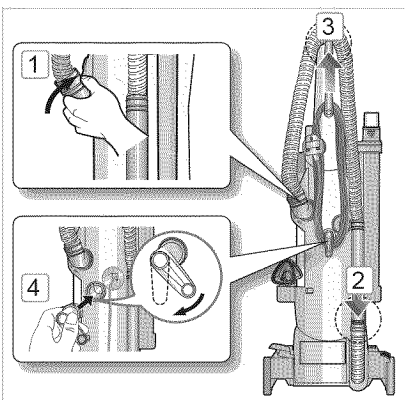

1. Align tabs on end of hose with slots in edge of hose attachment hole on back of vacuum. Push hose end in and turn clockwise to lock into place.
2. Slide the end of the hose wand onto the hose wand base.
Note: The vacuum will not operate properly unless the hose wand is firmly attached.
3. Snap the hose into the hose clip on the back of the vacuum handle.
4. Attach the lower cord wrap by lining up the tab on the base with the corresponding notch on the back of the vacuum and turn it clockwise as shown.

ASSEMBLY INSTRUCTIONS

EXTENSION WAND PLACEMENT

Place the crevice tool (A) in the top of the extension wand. Place the extension wand (B) in the wand holder on the side of the vacuum cleaner.

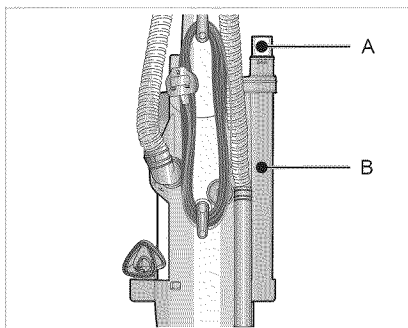

OPERATING INSTRUCTIONS

POWER CORD

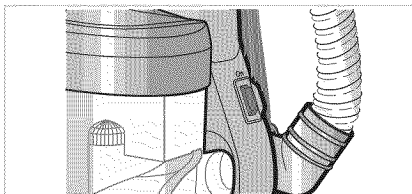

1. The power switch is located on the side of the vacuum. Push the rocker switch "ON" to vacuum, and "OFF" when cleaning is complete.



WARNING

To reduce the risk of electric shock, this appliance has a polarized plug (one blade is wider than the other). This plug will fit in a polarized outlet only one way. If the plug does not fit fully in the outlet, reverse the plug. If it still does not fit, contact a qualified electrician to install the proper outlet. Do not change the plug in any way.

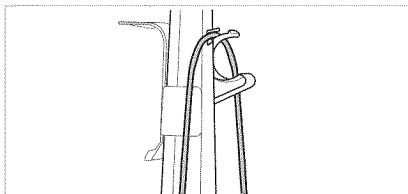

2. Unclip the power cord plug from the power cord. Place the power cord into the cord clip on the body as shown. This helps keep the power cord out from under the vacuum cleaner nozzle.
3. Plug the polarized power cord into a 120 Volt outlet located near the floor.
4. To store cord, turn upper cord wrap to the up position, then wrap cord.



WARNING

Personal Injury and Product Damage Hazard

- **DO NOT** plug in if switch is in the ON position. Personal injury or damage could result.
- **DO NOT** use outlets above counters. Damage from cord to items in surrounding area could occur.

FLOOR/CARPET CLEANING

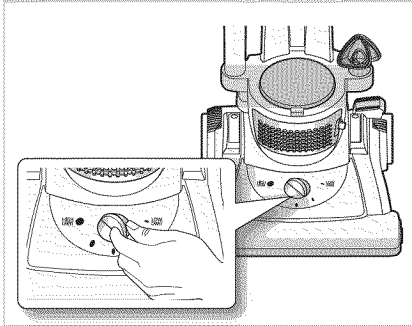

HEIGHT ADJUST KNOB

The power nozzle brushroll can be adjusted to clean several floor surfaces.

Note : For optimal cleaning performance, adjust to the lowest practical setting. If your cleaner is difficult to push, adjust to the next higher setting.

1. Turn Height Adjustment Knob to desired setting.

Lowest Setting

– For bare floors

Intermediate Setting

– For short and medium pile carpets

Highest Setting

– For plush pile carpet

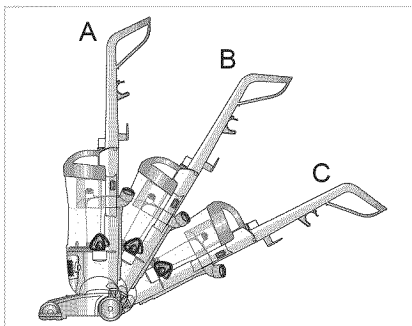

Press the handle release pedal, located on the lower left side of the vacuum, with your foot to place your vacuum into one of three cleaning positions.

1. Upright

– For storage and above floor cleaning with tools.

2. Normal Cleaning

– Press handle release pedal once. Position used for most household floor cleaning tasks.

3. Low Cleaning

– With the vacuum in normal cleaning position, press handle release pedal again. Use for reaching under low furniture such as tables, chairs or beds.

CARRY HANDLE (DUST BIN HANDLE)

Use the dust bin handle to carry from room to room.

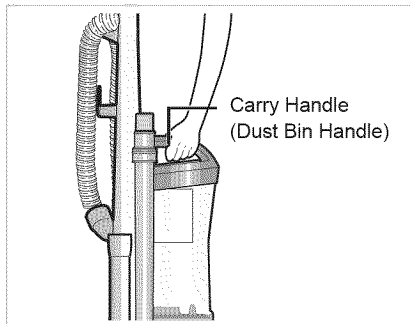

VACUUM CLEANER CARE

DUST BIN REMOVAL AND REPLACEMENT

WARNING

Electrical Shock and Personal Injury Hazard

Disconnect electrical supply before servicing or cleaning the unit.

Failure to do so could result in electrical shock or personal injury from vacuum cleaner suddenly starting.

EMPTY DUST BIN

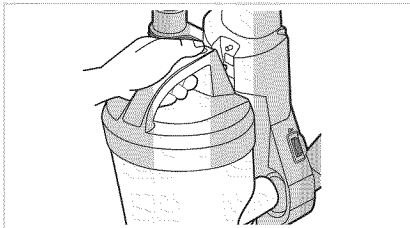

To remove the dust bin from the cleaner body, push the dust bin release button.



Hold dust bin over waste receptacle and push down on thumb button to release contents.

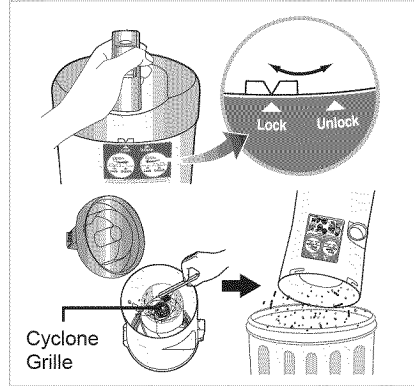

If the suction is weak although the dust bin is empty, open the cover and clean the cyclone grille.

After emptying dust bin, ensure that dust bin is attached to body properly.

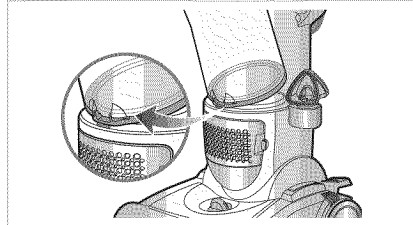

After emptying dirt, fit the groove located on the lower front side of the dust bin to the hook located on the cleaner body.

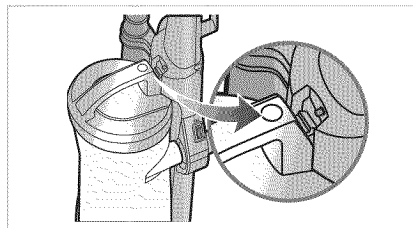

Attach the hook located on the dust bin handle to the vacuum body.

MOTOR FILTER REMOVAL AND REPLACEMENT

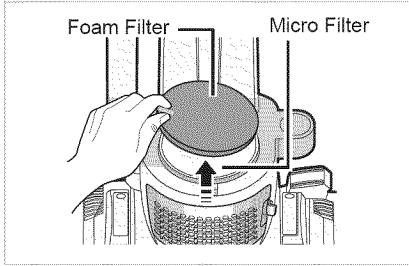

The motor filters(foam filter, micro filter) are located underneath the dust bin. If the filters become dirty, remove and clean them.

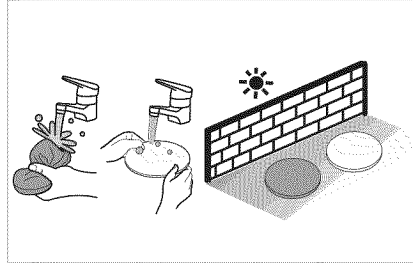

The motor filters(foam filter, micro filter) may be hand washed in cold water with mild detergent. Rinse well and air dry thoroughly before re-installing.

EXHAUST FILTER REMOVAL AND REPLACEMENT

WARNING

Electrical Shock and Personal Injury Hazard

Disconnect electrical supply before servicing or cleaning the unit.

Failure to do so could result in electrical shock or personal injury from vacuum cleaner suddenly starting.

Note : Inspect the exhaust filter regularly for dust accumulation, and clean if necessary.

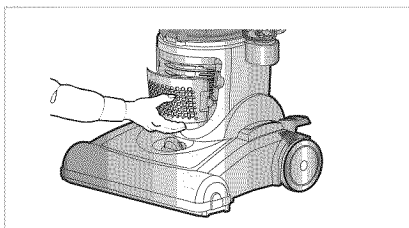

Grasp tab on exhaust filter cover and pivot forward to remove.

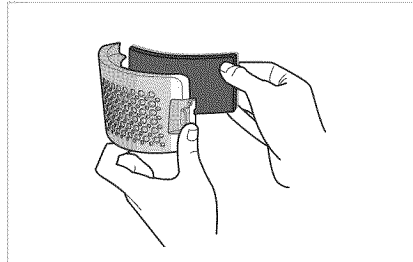

Remove exhaust filter from cover. Hold exhaust filter under running water to wash. Allow exhaust filter to dry for at least 24 hours.

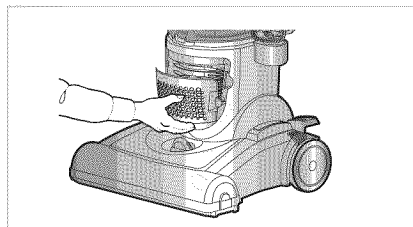

Return exhaust filter to cover and reattach to cleaner.

BELT OR BRUSHROLL REMOVAL AND REPLACEMENT



WARNING

Electrical Shock and Personal Injury Hazard

Disconnect electrical supply before servicing or cleaning the unit. Failure to do so could result in electrical shock or personal injury from vacuum cleaner suddenly starting.

TO REMOVE BELT

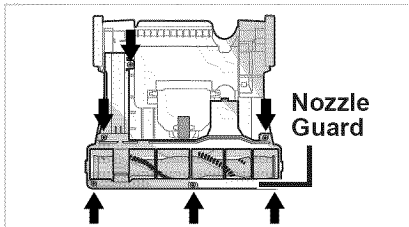

Lay cleaner flat and flip cleaner to expose nozzle base. Base should lay flat and face up. To remove nozzle guard, remove 6 screws.

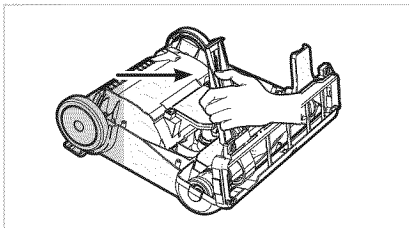

Rotate/pivot the nozzle guard and pull off.

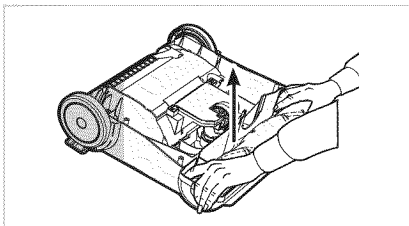

Lift and remove brushroll. Dispose of old belt.

TO REPLACE BELT OR BRUSHROLL

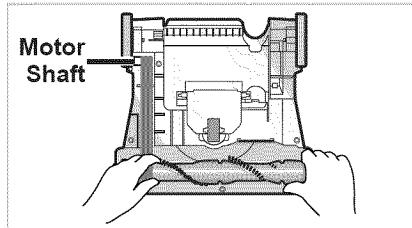

Slide belt onto motor shaft.

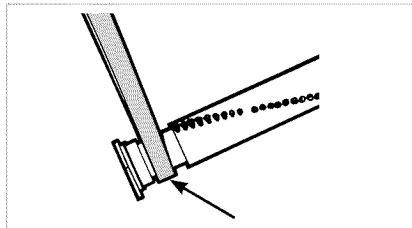

Place new belt in area of brushroll without bristles.

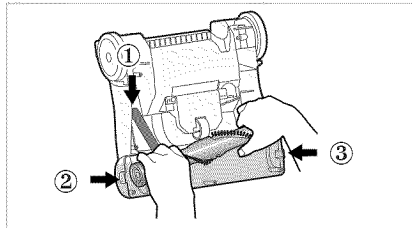

With new belt in place, pull and slide brushroll into nozzle making sure that the brushroll end caps are in the correct orientation. Rotate brushroll manually to make sure belt is properly aligned. Reposition brush cover and 6 screws. Tighten screws securely.

LIGHT BULB REPLACEMENT



WARNING

Electrical Shock and Personal Injury Hazard

Disconnect electrical supply before servicing or cleaning the unit. Failure to do so could result in electrical shock or personal injury from vacuum cleaner suddenly starting.

1. Using a screwdriver, remove a screw as shown and lift off the lens.
2. Remove the bulb from the socket by grasping bulb and pulling straight out.
3. Install the new bulb by pushing it gently into the socket until the bulb snaps into place.

TO REPLACE LIGHT BULB

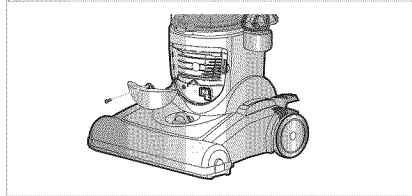
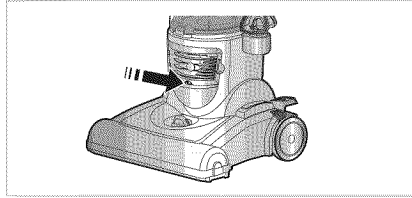

4. Reposition lens and secure with a screw.

TROUBLESHOOTING

Review this table to find do-it-yourself solutions for minor performance problems. Any service needed, other than maintenance described in this Use & Care Guide should be performed by a Sears or other qualified service agent.



WARNING Disconnect electrical supply before performing maintenance to the unit. Failure to do so could result in electrical shock or personal injury.

PROBLEM	POSSIBLE CAUSE	POSSIBLE SOLUTION
Cleaner won't run	1. Power cord not firmly plugged into outlet.	1. Plug unit in firmly.
	2. Blown house fuse or tripped house circuit breaker.	2. Check fuse or breaker in home. replace fuse / reset breaker.
Cleaner won't pick up or low suction.	1. Hose wand not firmly attached to hose wand base.	1. Make sure that hose wand is securely attached to hose wand base.
	2. Dust bin not installed correctly	2. Review dust bin removal and replacement - Pg.10
	3. Dust bin full.	3. Empty dust bin - Pg.10
	4. Brushroll worn	4. Replace brushroll - Pg.12
	5. Broken or worn belt.	5. Replace belt - Pg.12
	6. One or both filters clogged.	6. Remove filters and clean - Pg.11
	7. Carpet height setting is incorrect.	7. Set carpet height adjust lever to appropriate setting for carpet being cleaned - Pg.9
Dust escaping from cleaner	1. Dust bin full.	1. Empty dust bin - Pg.10
	2. Dust bin not installed correctly.	2. Review dust bin removal and replacement - Pg.10
	3. Hose not installed correctly.	3. Review hose placement - Pg.7
	4. Exhaust filter clogged.	4. Replace exhaust filter.
	5. Filter assembly not positioned properly.	5. Ensure that filter assembly is positioned properly.
	6. Motor filter clogged.	6. Clean motor filter
Cleaner tools won't pick up	1. Hose clogged.	1. Check inlets, hose and dust bin for obstructions: remove. If clog persists, take vacuum cleaner to a sears or other qualified service dealer.
	2. Dust bin full.	2. Empty dust bin - Pg.10
	3. One or both filters clogged.	3. Remove filters and clean - Pg.11
Headlight not working	1. Bulb burnt out.	1. Replace bulb - Pg.13
	2. Loose electrical wires.	2. Take to sears service center.
Cleaner is difficult to push	1. Carpet height setting is incorrect.	1. Set carpet height adjust lever to appropriate setting for carpet being cleaned - Pg.9
	2. Broken or worn belt.	2. Replace belt - Pg. 12

MASTER PROTECTION AGREEMENT

Congratulations on making a smart purchase. Your new Kenmore product is designed and manufactured for years of dependable operation. But like all products, it may require preventive maintenance or repair from time to time. That's when having a Master Protection Agreement can save you money and aggravation.

The Master Protection Agreement also helps extend the life of your new product. Here's what the Agreement* includes:

- ✓ **Parts and labor** needed to help keep products operating properly **under normal use**, not just defects. Our coverage goes **well beyond the product warranty**. No deductibles, no functional failure excluded from coverage – **real protection**.
- ✓ **Expert service** by a force of more than **10,000 authorized Sears service technicians**, which means someone you can trust will be working on your product.
- ✓ **Unlimited service calls and nationwide service**, as often as you want us, when ever you want us.
- ✓ **"No-lemon" guarantee** – replacement of your covered product if four or more product failures occur within twelve months.
- ✓ **Product replacement** if your covered product can't be fixed.
- ✓ **Annual Preventive Maintenance Check** at your request – no extra charge.
- ✓ **Fast help by phone** – we call it **Rapid Resolution** – phone support from a Sears representative on all products. Think of us as a "talking owner's manual."
- ✓ **Power surge protection** against electrical damage due to power fluctuations.
- ✓ **\$250 Food Loss Protection** annually for any food spoilage that is the result of mechanical failure of any covered refrigerator or freezer.
- ✓ **Rental reimbursement** if repair of your covered product takes longer than promised.
- ✓ **10% discount** off the regular price of any non-covered repair service and related installed parts.

Once you purchase the Agreement, a simple phone call is all that it takes for you to schedule service. You can call anytime day or night, or schedule a service appointment online.

The Master Protection Agreement is a risk free purchase. If you cancel for any reason during the product warranty period, we will provide a full refund. Or, a prorated refund anytime after the product warranty period expires. Purchase your Master Protection Agreement today!

Some limitations and exclusions apply. For prices and additional information in the U.S.A. call 1-800-827-6655.

* Coverage in Canada varies on some items. For full details call Sears Canada at 1-800-361-6665.

Sears Installation Service

For Sears professional installation of home appliances, garage door openers, water heaters, and other major home items, in the U.S.A. or Canada call **1-800-4-MY-HOME®**.

Get it fixed, at your home or ours!

Your Home

For expert troubleshooting and home solutions advice:

manage my home

www.managemyhome.com

For repair – **in your home** – of **all** major brand appliances, lawn and garden equipment, or heating and cooling systems, **no matter who made it, no matter who sold it!**

For the replacement parts, accessories and owner's manuals that you need to do-it-yourself.

For Sears professional installation of home appliances and items like garage door openers and water heaters.

1-800-4-MY-HOME[®]

(1-800-469-4663)

www.sears.com

Call anytime, day or night

(U.S.A. and Canada)

www.sears.ca

Our Home

For repair of carry-in items like vacuums, lawn equipment, and electronics, call anytime for the location of the nearest

Sears Parts & Repair Service Center

1-800-488-1222 (U.S.A.)

www.sears.com

1-800-469-4663 (Canada)

www.sears.ca

To purchase a protection agreement on a product serviced by Sears:

1-800-827-6655 (U.S.A.)

1-800-361-6665 (Canada)

Para pedir servicio de reparación a domicilio, y para ordenar piezas:

1-888-SU-HOGAR[®]

(1-888-784-6427)

Au Canada pour service en français:

1-800-LE-FOYER^{MC}

(1-800-533-6937)

www.sears.ca



© Sears Brands, LLC

® Registered Trademark / TM Trademark / SM Service Mark of Sears Brands, LLC

® Marca Registrada / TM Marca de Fábrica / SM Marca de Servicio de Sears Brands, LLC

^{MC} Marque de commerce / ^{MD} Marque déposée de Sears Brands, LLC

Free Manuals Download Website

<http://myh66.com>

<http://usermanuals.us>

<http://www.somanuals.com>

<http://www.4manuals.cc>

<http://www.manual-lib.com>

<http://www.404manual.com>

<http://www.luxmanual.com>

<http://aubethermostatmanual.com>

Golf course search by state

<http://golfingnear.com>

Email search by domain

<http://emailbydomain.com>

Auto manuals search

<http://auto.somanuals.com>

TV manuals search

<http://tv.somanuals.com>