

Owner's Manual



THE ECONOMIZER™ 6 COMPACT ELECTRIC WATER HEATER

FOR POTABLE WATER HEATING ONLY.
NOT SUITABLE FOR SPACE HEATING.

MODEL NO.

153.316040	6 GALLON
153.316050	10 GALLON
153.316060	19 GALLON SHORT
153.316070	19.9 GALLON TALL
153.316331	30 GALLON
153.326060	19 GALLON 240 V. SHORT
153.326070	19.9 GALLON 240 V. TALL
153.326331	30 GALLON 240 V.



- Safety Instructions
- Installation
- Operation
- Care and Maintenance
- Troubleshooting
- Parts List



GAMA certification applies to all residential electric water heaters with capacities of 20 to 120 Gallons. Input rating of 12kW or less.

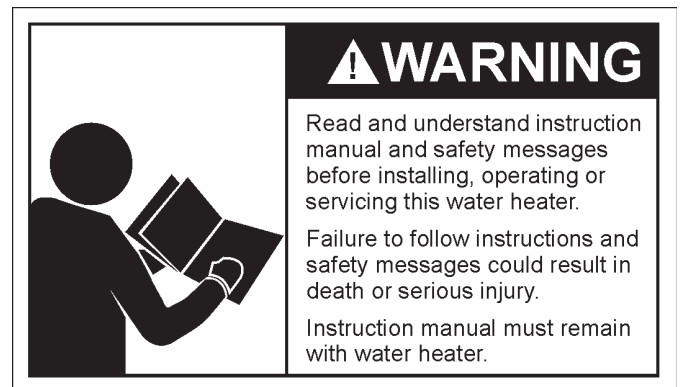

SAVE THIS MANUAL FOR FUTURE REFERENCE.





Sears, Roebuck and Co., Hoffman Estates, IL 60179 U.S.A

SAFE INSTALLATION, USE AND SERVICE

Your safety and the safety of others is extremely important in the installation, use and servicing of this water heater.

Many safety-related messages and instructions have been provided in this manual and on your own water heater to warn you and others of a potential injury hazard. Read and obey all safety messages and instructions throughout this manual. It is very important that the meaning of each safety message is understood by you and others who install, use or service this water heater.

	This is the safety alert symbol. It is used to alert you to potential personal injury hazards. Obey all safety messages that follow this symbol to avoid possible injury or death.
---	--

	DANGER indicates an imminently hazardous situation which, if not avoided, could result in death or injury.
	WARNING indicates a potentially hazardous situation which, if not avoided, could result in death or injury.
	CAUTION indicates a potentially hazardous situation which, if not avoided, may result in minor or moderate injury.
	CAUTION used without the safety alert symbol indicates a potentially hazardous situation which, if not avoided, could result in property damage.

All safety messages will generally tell you about the type of hazard, what can happen if you do not follow the safety message and how to avoid the risk of injury.

The California Safe Drinking Water and Toxic Enforcement Act requires the Governor of California to publish a list of substances known to the State of California to cause cancer, birth defects, or other reproductive harm, and requires businesses to warn of potential exposure to such substances.

This product contains a chemical known to the State of California to cause cancer, birth defects, or other reproductive harm. This appliance can cause low level exposure to some of the substances listed, including formaldehyde.

IMPORTANT DEFINITIONS

- **Sears Service Center:** The Sears Service Center has the ability equivalent to a licensed tradesman in the fields of plumbing and electrical work including a thorough understanding of the requirements of the National Electrical Code as it relates to the installation of electric water heaters. The Sears Service Center also has a thorough understanding of this instruction manual, and is able to perform repairs strictly in accordance with the service guidelines provided by the manufacturer.

GENERAL SAFETY

	<h2>⚠ WARNING</h2> <p>Read and understand instruction manual and safety messages before installing, operating or servicing this water heater.</p> <p>Failure to follow instructions and safety messages could result in death or serious injury.</p> <p>Instruction manual must remain with water heater.</p>
---	---

<h2>CAUTION</h2> <p>Improper installation and use may result in property damage.</p>
<ul style="list-style-type: none"> • Do not operate water heater if flood damaged. • Inspect and replace the anode as needed. • Install in location with drainage. • Fill tank with water before operation. • Be alert for thermal expansion. <p>Refer to instruction manual for installation and service.</p>

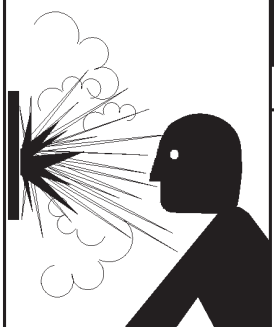
	<h2>⚠ WARNING</h2> <p>Explosion Hazard</p>
	<ul style="list-style-type: none"> • Overheated water can cause water tank explosion. • Properly sized temperature and pressure relief valve must be installed in opening provided.

	<h2>⚠ WARNING</h2>
	<ul style="list-style-type: none"> • Before removing any access panels or servicing the water heater, make sure the electrical supply to the water heater is turned "OFF". • Failure to do this could result in death, serious bodily injury, or property damage.

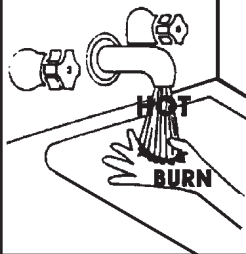
	<h2>⚠ DANGER</h2> <p>Water temperature over 125°F (52°C) can cause severe burns instantly resulting in severe injury or death.</p> <p>Children, the elderly, and the physically or mentally disabled are at highest risk for scald injury.</p> <p>Feel water before bathing or showering.</p> <p>Temperature limiting valves are available.</p> <p>Read instruction manual for safe temperature setting.</p>
---	--



<h2>⚠ WARNING</h2> <p>Fire Hazard / Electric Shock Hazard</p>	
	<ul style="list-style-type: none"> • Do not use this water heater with any voltage other than shown on the model rating plate. • Failure to use the correct voltage shown on the model rating plate could result in death, serious bodily injury, or property damage.
	

TABLE OF CONTENTS

SAFE INSTALLATION, USE AND SERVICE.....	2	Temperature Settings.....	13
GENERAL SAFETY.....	3	Thermostat Adjustment.....	13
TABLE OF CONTENTS.....	4	Temperature-Pressure Relief Valve Operation	13
INTRODUCTION.....	5	Draining	13,14
PRODUCT SPECIFICATIONS	5	Thermostat Removal/Replacement.....	14
MATERIALS AND BASIC TOOLS NEEDED	6	Element Cleaning/Replacement	14-16
Materials Needed.....	6	Drain Valve Washer Replacement.....	17
Basic Tools.....	6	Anode Rod Inspection	17
Additional Tools Needed When Sweat Soldering	6	Service.....	17
INSTALLATION INSTRUCTIONS	7-12	TROUBLESHOOTING GUIDE.....	18-20
Removing the Old Water Heater.....	7,8	Start Up Conditions	18
Facts to Consider About the Location.....	8	Thermal Expansion.....	18
Insulation Blankets.....	8	Strange Sounds.....	18
Water Piping	9,10	Operational Conditions	18-20
T & P Valve and Pipe Insulation.....	10	Smelly Water.....	18,19
Temperature-Pressure Relief Valve	10,11	“Air” in Hot Water Faucets	19
Filling the Water Heater	11	Rumbling Noise	19
Wiring	11,12	High Temperature Shut Off System	19
Wiring Diagrams	11	Not Enough or No Hot Water	20
Wiring Connections.....	12	Water Is Too Hot	20
SERVICE AND ADJUSTMENT	12-17	Leakage Checkpoints	21
Temperature Regulation	12	REPAIR PARTS LIST	22,23
Thermostat.....	12	WARRANTY	24

INTRODUCTION

Thank You for purchasing a Sears water heater. Properly installed and maintained, it should give you years of trouble free service. It is strongly suggested that this new water heater be professionally installed, contact the local Sears Service Center or any Sears store. They will arrange for prompt, quality installation by Sears authorized contractors.

Abbreviations Found In This Instruction Manual:

- ANSI - American National Standards Institute
- ASME - American Society of Mechanical Engineers
- GAMA - Gas Appliance Manufacturers Association
- NEC - National Electrical Code
- NFPA - National Fire Protection Association
- UL - Underwriters Laboratories Inc.

PREPARING FOR THE INSTALLATION

1. Read the “General Safety” section of this manual first and then the entire manual carefully. If you don’t follow the

safety rules, the water heater will not operate properly. It could cause DEATH, SERIOUS BODILY INJURY, AND/OR PROPERTY DAMAGE.

This manual contains instructions for the installation, operation, and maintenance of the electric water heater. It also contains warnings throughout the manual that you must read and understand. All warnings and all instructions are essential to the proper operation of the water heater and your safety. **READ THE ENTIRE MANUAL BEFORE ATTEMPTING TO INSTALL OR OPERATE THE WATER HEATER.**

2. The installation must conform with these instructions and the local code authority having jurisdiction and the requirements of the power company. In the absence of local code requirements follow NFPA-70, the National Electrical Code (current edition), which may be ordered from: National Fire Protection Association, 1 Batterymarch Park, Quincy, MA 02269.
3. If after reading this manual you have any questions or do not understand any portion of the instructions, call Sears Service Center.
4. Carefully plan your intended placement of the water heater. **INSTALLATION OR SERVICE OF THIS WATER**

HEATER REQUIRES ABILITY EQUIVALENT TO THAT OF A LICENSED TRADESMAN IN THE FIELD INVOLVED. PLUMBING AND ELECTRICAL WORK ARE REQUIRED.

Examine the location to ensure the water heater complies with the "Facts to Consider About the Location" section in this manual.

5. For California installation this water heater must be braced, anchored, or strapped to avoid falling or moving during

an earthquake. See instructions for correct installation procedures. Instructions may be obtained from California Office of the State Architect, 400 P Street, Sacramento, CA 95814.

6. Massachusetts Code requires this water heater to be installed in accordance with Massachusetts 248-CMR 2.00: State Plumbing Code and 248-CMR 5.00.

PRODUCT SPECIFICATIONS

MODEL NUMBER	TANK CAPACITY IN GALLONS (LITERS)	DIMENSIONS IN INCHES (mm)		RECOVERY RATE GALS.PER HOUR @90°F Rise	ELEMENT WATTAGE		MINIMUM WIRE SIZE* (GAUGE)	MAXIMUM FUSE OR CIRCUIT BREAKER SIZE (AMPS)
		DIA.	HEIGHT		120 Volt	240 Volt		
153.316040	6 (22.7)	14.250" (362)	15.375" (391)	7.5	1650	----	12	20
153.316050	10 (37.8)	16" (406)	18.25" (464)	7.5	1650	----	12	20
153.316060	19 (71.9)	18" (457)	24.9" (632)	7.5	1650	----	12	20
153.316070	19.9 (75.3)	16" (406)	31.62" (803)	7.5	1650	----	12	20
153.316331	30 (113.6)	22" (559)	30" (762)	7.5	1650	----	12	20
153.326060	19 (71.9)	18" (457)	24.9" (632)	9.1	----	2000	14	15
153.326070	19.9 (75.3)	16" (406)	31.62" (803)	9.1	----	2000	14	15
153.326331	30 (113.6)	22" (559)	30" (762)	9.1	----	2000	14	15

* Wiring size based on standard 60°C copper wire. If distance from fuse box to water heater is more than 90 feet, refer to your local electrical code.

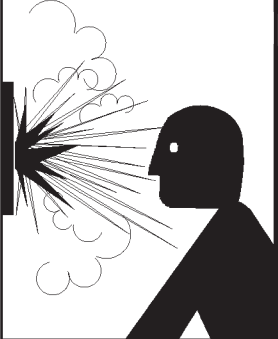

! WARNING

Explosion Hazard

- Models with optional Top Hot Outlet or T&P location are identified as EITHER Hot Outlet or T&P.
- Models with optional installation locations on jacket top can NOT be installed with both Hot Outlet and T&P located on top.
- Never attempt to use Cold inlet on jacket top as Hot Outlet or T&P.
- Connections should only be used as identified on heater. Failure to use them properly could result in damage to the water heater, serious bodily injury, or death.

Some compact models have labeled optional plumbing connections see below.

MODEL NUMBER	STANDARD SIDE COLD INLET	STANDARD SIDE HOT INLET	STANDARD SIDE T&P	MODEL HAS OPTIONAL TOP COLD INLET	MODEL HAS OPTIONAL TOP HOT OUTLET OR T&P
153.316040	YES	YES	YES	YES, PLUGGED	YES, PLUGGED
153.316050	YES	YES	YES	NO	YES, PLUGGED
153.316060	YES	YES	YES	YES, PLUGGED	YES, PLUGGED
153.316070	YES	YES	YES	YES, PLUGGED	YES, PLUGGED
153.316331	YES	YES	YES	NO	NO
153.326060	YES	YES	YES	YES, PLUGGED	YES, PLUGGED
153.326070	YES	YES	YES	YES, PLUGGED	YES, PLUGGED
153.326331	YES	YES	YES	NO	NO

MATERIALS AND BASIC TOOLS NEEDED

Materials Needed

To simplify the installation Sears has available the installation parts shown below. You may or may not need all of these materials, depending on your type of installation.

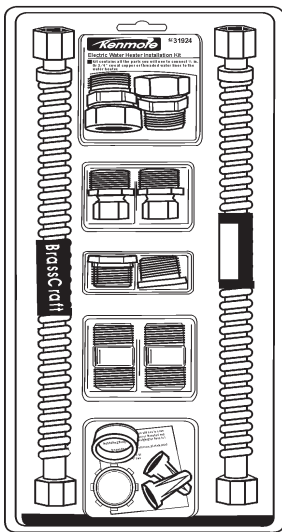

WATER HEATER INSTALLATION KIT WITH FLEXIBLE CONNECTORS FOR 3/4" OR 1/2" THREADED OR COPPER PLUMBING.

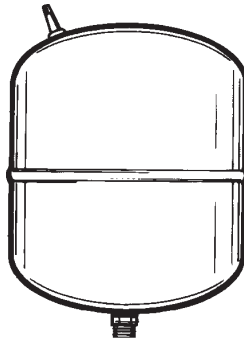

EXPANSION TANKS FOR THERMAL EXPANSION CONDITIONS AVAILABLE IN 2 GALLONS, AND 5 GALLONS CAPACITY THROUGH LOCAL SEARS STORE OR SERVICE CENTER.

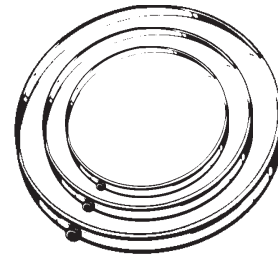

DRAIN PANS AVAILABLE IN 20" DIAMETER FOR WATER HEATERS HAVING A DIAMETER 18" OR LESS, 24" DIAMETER FOR WATER HEATERS HAVING A DIAMETER 22" OR LESS AND AVAILABLE IN 28" DIAMETER FOR WATER HEATERS HAVING A DIAMETER 26" OR LESS.

Basic Tools

You may or may not need all of these tools, depending on your type of installation. These tools can be purchased at your local Sears store.

- Pipe Wrench (2)
- Screwdriver
- 6 Foot Tape or Folding Rule
- Garden Hose
- Drill
- Pipe Dope or Teflon Tape



ROLL OF TEFLON TAPE (USE ON WATER CONNECTIONS)



PIPE DOPE (SQUEEZE TUBE) USE FOR WATER CONNECTIONS



GARDEN HOSE



6 FOOT TAPE

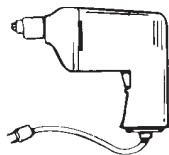

DRILL



SLOT-HEAD SCREWDRIVER



PHILLIPS SCREWDRIVER



PIPE WRENCH

Additional Tools Needed When Sweat Soldering

- Tubing Cutters or Hacksaw
- Propane Torch
- Soft Solder
- Solder Flux
- Emery Cloth
- Wire Brushes



TUBING CUTTER

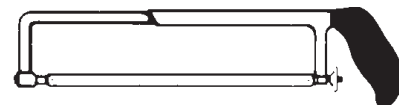

HACKSAW



ROLL OF EMERY CLOTH



ROLL OF LEAD-FREE SOFT SOLDER



SOLDER FLUX



PROPANE TORCH



3/4" (19 mm) WIRE BRUSH



1/2" (13 mm) WIRE BRUSH

INSTALLATION INSTRUCTIONS

Removing the Old Water Heater

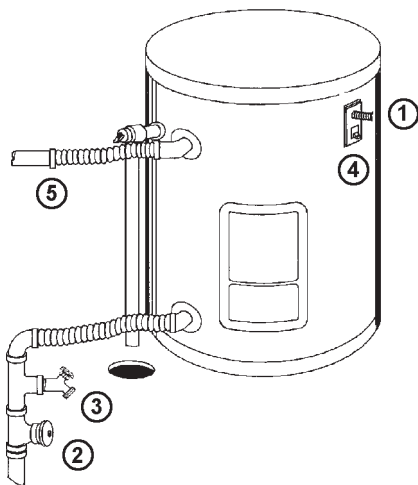

FIGURE 1.

1. Turn "OFF" electrical supply to the water heater.

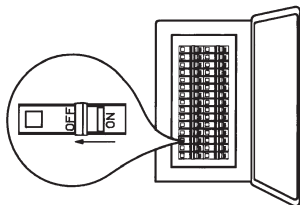

FIGURE 2.

2. Turn "OFF" the water supply to the water heater at the water shut-off valve or water meter.

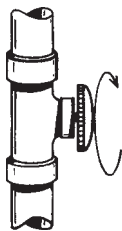

FIGURE 3.

3. Attach a hose to the water heater drain valve and put the other end in a floor drain or outdoors. Open the water heater drain valve. Open a nearby hot water faucet which will relieve pressure in the water heater and speed draining.

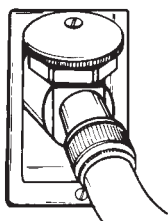
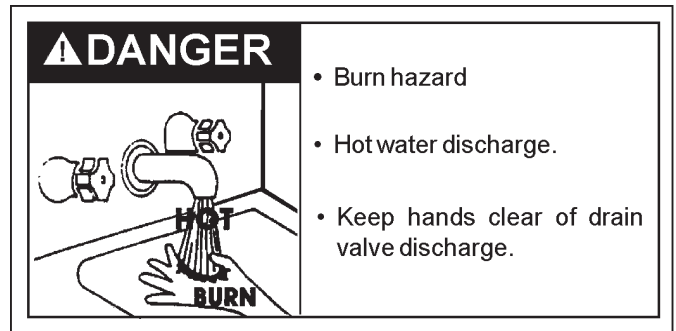

FIGURE 4.



The water passing out of the drain valve may be extremely hot. To avoid being scalded, make sure all connections are tight and that the water flow is directed away from any person.

4. Check again to make sure the electrical supply is turned "OFF" to the water heater. Then disconnect the electrical supply connection from the water heater junction box.

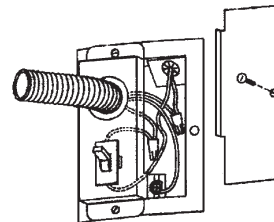

FIGURE 5.

5. a. If you have copper piping to the water heater, the two copper water pipes can be cut with a hacksaw approximately four inches away from where they connect to the water heater. This will avoid cutting off the pipes too short. Additional cuts can be made later if necessary. Disconnect the temperature-pressure relief valve drain line. When the water heater is drained, disconnect the hose from the drain valve. Close the drain valve. The water heater is now completely disconnected and ready to be removed.

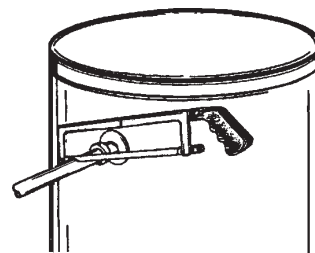

FIGURE 6.

- b. If you have galvanized pipe to the water heater, loosen the two galvanized pipes with a pipe wrench at the union in each line. Also disconnect the piping remaining to the water heater. These pieces should be saved since they may be needed when reconnecting the new water heater. Disconnect the temperature-pressure relief valve drain line. When the water heater is drained, disconnect the hose from the drain valve. Close the drain valve. The water heater is now completely disconnected and ready to be removed.

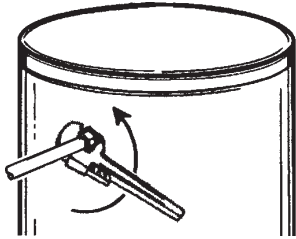

FIGURE 7.

CAUTION
Mineral Buildup or Sediment May Accumulate
<ul style="list-style-type: none"> • This causes the water heater to become much heavier than normal. • If spilled, could cause staining.

Mineral buildup or sediment may have accumulated in the old water heater. This causes the water heater to be much heavier than normal and this residue, if spilled out, could cause staining.

Facts to Consider About the Location

You should carefully choose an indoor location for the new water heater, because the placement is a very important consideration for the safety of the occupants in the building and for the most economical use of the appliance. **This water heater is not intended for outdoor installation.**

Whether replacing an old water heater or putting the water heater in a new location, the following critical points must be observed.

- The location selected should be indoors as close to and as centralized with the water piping system as possible. This water heater, as well as all water heaters, will eventually leak. Do not install without adequate drainage provisions so water flow will not cause damage.

CAUTION
Property Damage Hazard
<ul style="list-style-type: none"> • All water heaters eventually leak • Do not install without adequate drainage.

WATER HEATERS EVENTUALLY LEAK: Installation of the water heater must be accomplished in such a manner that if the tank or any connections should leak, the flow of water will not cause damage to the structure. When such locations cannot be avoided, a suitable drain pan should be installed under the water heater. Drain pans are available at your local Sears stores. Such drain pans must be piped to an adequate drain.

Water heater life depends upon water quality, water pressure and the environment in which the water heater is installed. Water heaters are sometimes installed in locations where leakage may result in property damage, even with the use of a drain pan piped to a drain. However, unanticipated damage can be reduced or prevented by a leak detector or water shut-off device used in conjunction with a piped drain pan. These devices are available from some plumbing wholesalers and retailers, and detect and react to leakage in various ways:

- Sensors mounted in the drain pan that trigger an alarm or turn off the incoming water to the water heater when leakage is detected.
- Sensors mounted in the drain pan that turn off the water supply to the entire home when water is detected in the drain pan.
- Water supply shut-off devices that activate based on the water pressure differential between the cold water and hot water pipes connected to the water heater.

CAUTION
Installations in Residential Garages
<ul style="list-style-type: none"> • Water heater must be located in a protective area.

INSTALLATION IN RESIDENTIAL GARAGES: The water heater must be located and/or protected so it is not subject to physical damage by a moving vehicle.

- The location selection must provide adequate clearances for servicing and proper operation of the water heater.

Insulation Blankets

Insulation blankets are available to the general public for external use on electric water heaters but are not necessary with this product. The purpose of an insulation blanket is to reduce the standby heat loss encountered with storage tank heaters. Your water heater meets or exceeds the National Appliance Energy Conservation Act standards with respect to insulation and standby loss requirements, making an insulation blanket unnecessary.

Should you choose to apply an insulation blanket to this heater, you should follow these instructions below. Failure to follow these instructions can result in fire, serious personal injury, or death.

- Do not cover the temperature and pressure relief (T & P) valve with an insulation blanket.
- Do not cover the instruction manual. Keep it on the side of the water heater or nearby for future reference.
- Do obtain new warning and instruction labels for placement on the blanket directly over the existing labels.

Water Piping

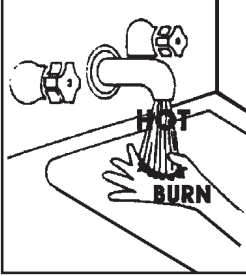
	<p>⚠ DANGER Water temperature over 125°F (52°C) can cause severe burns instantly resulting in severe injury or death.</p> <p>Children, the elderly, and the physically or mentally disabled are at highest risk for scald injury.</p> <p>Feel water before bathing or showering.</p> <p>Temperature limiting valves are available.</p> <p>Read instruction manual for safe temperature setting.</p>
---	--

HOTTER WATER CAN SCALD: Water heaters are intended to produce hot water. Water heated to a temperature which will satisfy clothes washing, dish washing, and other sanitizing needs can scald and permanently injure you upon contact. Some people are more likely to be permanently injured by hot water than others. These include the elderly, children, the infirm, or physically/mentally handicapped. If anyone using hot water in your home fits into one of these groups or if there is a local code or state law requiring a certain temperature water at the hot water tap, then you must take special precautions. In addition to using the lowest possible temperature setting that satisfies your hot water needs, a means such as a mixing valve, shall be used at the hot water taps used by these people or at the water heater. Mixing valves are available at plumbing supply or hardware stores. Follow manufacturers instructions for installation of the valves. Before changing the factory setting on the thermostat, read the "Temperature Regulation" section in this manual.

See Figure 8 for mixing valve usage.

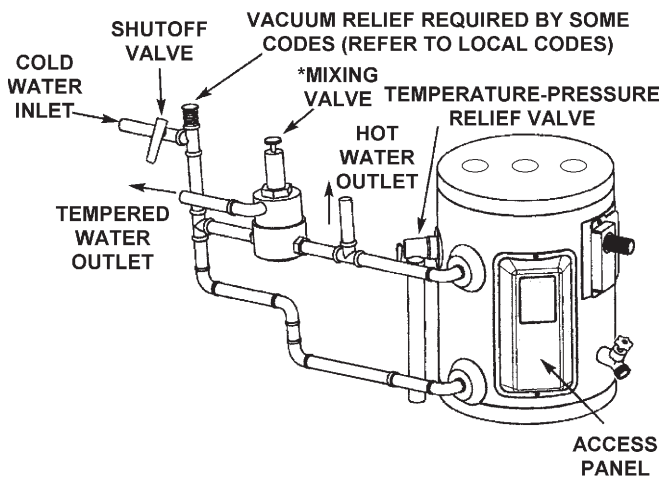

FIGURE 8.

Figure 9 shows the attachment of the water piping to the water heater. The water heater is equipped with 3/4" water connections.

If a water heater is installed in a closed water supply system; such as one having a back-flow preventer, check valve, water

meter with a check valve, etc... in the cold water supply; means must be provided to control thermal expansion. Contact the local utility or Sears Service Center on how to control this situation.

NOTE: If using copper tubing, solder tubing to an adapter before attaching the adapter to the water connections. Do not solder the water supply lines directly to the connections. It will harm the fittings on the water heater.

<p>CAUTION</p> <p>Property Damage Hazard</p>
<ul style="list-style-type: none"> • Avoid water heater damage. • Install thermal expansion tank if necessary. • Do not apply heat to cold water inlet. • Contact qualified installer or service agency.

NOTE: To protect against untimely corrosion of hot and cold water fittings, it is strongly recommended that dielectric unions or couplings be installed on this water heater when connected to copper pipe.

1. Look at the side of the water heater. The hot water outlet is marked hot. Put two or three turns of teflon tape around the threaded end of the threaded-to-sweat coupling and around the 3/4" threaded nipple. Using flexible connectors, connect the hot water pipe to the hot water outlet of the water heater.
2. Look at the side of the water heater. The cold water inlet is marked cold. Put two or three turns of teflon tape around the threaded end of the threaded-to-sweat coupling and around the 3/4" threaded nipple. Using flexible connectors, connect the cold water pipe to the cold water inlet of the water heater.

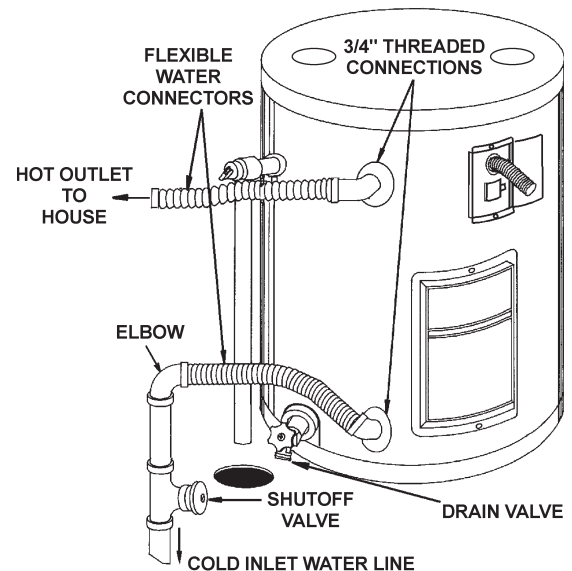
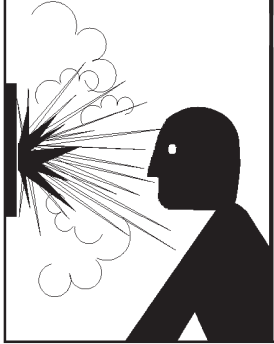

FIGURE 9.

NOTE: Your water heater is insulated to minimize heat loss from the tank. Further reduction in heat loss can be accomplished by insulating the hot water lines from the water heater.

Optional Installation Instructions



! WARNING

Explosion Hazard

- Models with optional Top Hot Outlet or T&P location are identified as EITHER Hot Outlet or T&P.
- Models with optional installation locations on jacket top can NOT be installed with both Hot Outlet and T&P located on top.
- Never attempt to use Cold inlet on jacket top as Hot Outlet or T&P.
- Connections should only be used as identified on heater. Failure to use them properly could result in damage to the water heater, serious bodily injury, or death.

Some compact models have optional plumbing connections. On these units, if top connection is preferred over the side connection, use the following instructions as they apply to your connection:

To change Temperature and Pressure (T&P) valve location: Remove 3/4" plug from opening in jacket top. Replace 3/4" plug opening with T&P valve; plug original T&P valve opening with 3/4" plug. **BE SURE TO REAPPLY PIPE JOINT COMPOUND OR TEFLON TAPE AROUND THE THREADED ENDS OF THE TEMPERATURE AND PRESSURE (T&P) VALVE AND THE 3/4" PLUG WHEN REINSTALLING COMPONENTS.**

To change Cold Inlet location: Remove 3/4" plug from opening in jacket top. Replace 3/4" plug opening with Cold Inlet nipple; plug original Cold Inlet opening with 3/4" plug. **BE SURE TO REAPPLY PIPE JOINT COMPOUND OR TEFLON TAPE AROUND THE THREADED ENDS OF THE COLD INLET NIPPLE AND THE 3/4" PLUG WHEN REINSTALLING COMPONENTS.**

To change Hot Outlet location: Screw 3/4" NPT galvanized cap (not included, purchase locally) onto Side Hot Outlet and install 3/4" NPT nipple (not included, purchase locally) in the opening identified as HOT/T&P location. **BE SURE TO REAPPLY PIPE JOINT COMPOUND OR TEFLON TAPE AROUND THE THREADED ENDS OF THE 3/4" NPT NIPPLES WHEN REINSTALLING COMPONENTS.**

T & P Valve and Pipe Insulation

Remove insulation for T & P valve and pipe connections from carton.

Fit pipe insulation over the incoming cold water line and the hot water line. Make sure that the insulation is against the side jacket of the heater.

Fit T & P valve insulation over valve. Make sure that the insulation does not interfere with the lever of the T & P valve.

Secure all insulation using tape.

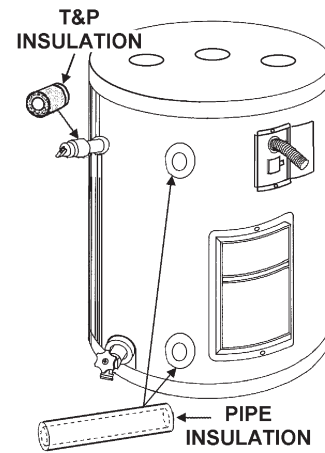
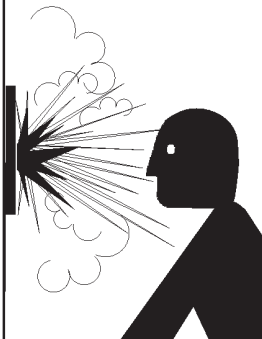

FIGURE 9A.

NOTE: Figure above is used to illustrate installation of T&P and pipe insulation only. As indicated in PRODUCT SPECIFICATION Section. Actual optional Cold & Hot / T&P spud location vary from model to model.

Temperature-Pressure Relief Valve



! WARNING

Explosion Hazard

- Temperature-pressure relief valve must comply with ANSI Z21.22 - CSA 4.4 and ASME code.
- Properly sized temperature-relief valve must be installed in opening provided.
- Can result in overheating and excessive tank pressure.
- Can cause serious injury or death.

This heater is provided with a properly certified combination temperature - pressure relief valve by the manufacturer.

The valve is certified by a nationally recognized testing laboratory that maintains periodic inspection of production of listed equipment of materials as meeting the requirements for Relief for Hot Water Supply Systems, ANSI Z21.22 • CSA 4.4, and the code requirements of ASME.

If replaced, the valve must meet the requirements of local codes, but not less than a combination temperature and pressure relief valve certified as indicated in the above paragraph.

The valve must be marked with a maximum set pressure not to exceed the marked hydrostatic working pressure of the water heater (150 psi = 1,035 kPa) and a discharge capacity not less than the water heater input rate as shown on the model rating plate. (Electric heaters - watts x 3.412 equal Btu/hr input rate)

Your local jurisdictional authority, while mandating the use of a temperature-pressure relief valve complying with ANSI Z21.22 • CSA 4.4, may require a valve model different from the one furnished with the water heater.

Compliance with such local requirements must be satisfied by the installer or end user of the water heater with a locally

prescribed temperature-pressure relief valve installed in the designated opening in the water heater in place of the factory furnished valve.

For safe operation of the water heater, the relief valve must not be removed from its designated opening nor plugged.

The temperature-pressure relief valve must be installed directly into the fitting of the water heater designed for the relief valve. Position the valve downward and provide tubing so that any discharge will exit only within 6 inches (153 mm) above, or at any distance below the structural floor. Be certain that no contact is made with any live electrical part. The discharge opening must not be blocked or reduced in size under any circumstances. Excessive length, over 30 feet (9.14 m), or use of more than four elbows can cause restriction and reduce the discharge capacity of the valve.

CAUTION
Water Damage Hazard
<ul style="list-style-type: none"> • Temperature-pressure relief valve discharge pipe must terminate at adequate drain.

No valve or other obstruction is to be placed between the relief valve and the tank. Do not connect tubing directly to discharge drain unless a 6 inch air gap is provided. To prevent bodily injury, hazard to life, or property damage, the relief valve must be allowed to discharge water in quantities should circumstances demand. If the discharge pipe is not connected to a drain or other suitable means, the water flow may cause property damage.

The Discharge Pipe:

- Shall not be smaller in size than the outlet pipe size of the valve, or have any reducing couplings or other restrictions.
- Shall not be plugged or blocked.
- Shall be of material listed for hot water distribution.
- Shall be installed so as to allow complete drainage of both the temperature-pressure relief valve, and the discharge pipe.
- Shall terminate at an adequate drain.
- Shall not have any shut-off valve between the relief valve and tank nor in the discharge pipe.

⚠ DANGER	<p>Water temperature over 125°F (52°C) can cause severe burns instantly resulting in severe injury or death.</p> <p>Children, the elderly, and the physically or mentally disabled are at highest risk for scald injury.</p> <p>Feel water before bathing or showering.</p> <p>Temperature limiting valves are available.</p> <p>Read instruction manual for safe temperature setting.</p>

The temperature-pressure relief valve must be manually operated at least once a year. Caution should be taken to ensure that (1) no one is in front of or around the outlet of the temperature-pressure relief valve discharge line, and (2) the water manually discharged will not cause any bodily injury or property damage because the water may be extremely hot.

If after manually operating the valve, it fails to completely reset and continues to release water, immediately close the cold water inlet to the water heater, follow the draining instructions, and replace the temperature-pressure relief valve with a new one.

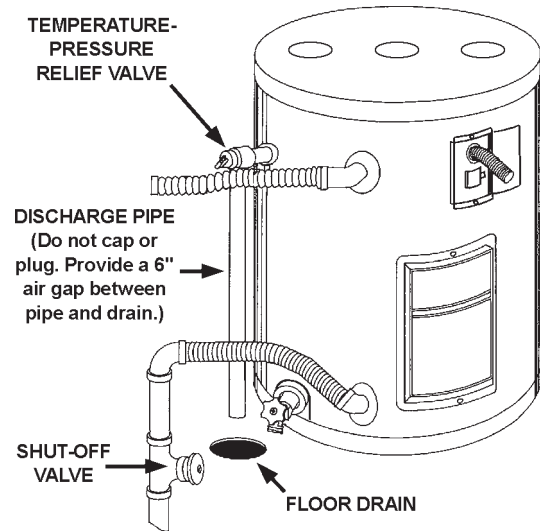

FIGURE 10.

Filling the Water Heater

CAUTION
Property Damage Hazard
<ul style="list-style-type: none"> • Avoid water heater damage. • Fill tank with water before operating.

Never use this water heater unless it is completely full of water. To prevent damage to the tank and heating element, the tank must be filled with water. Water must flow from the hot water faucet before turning "ON" power.

To fill the water heater with water:

- Close the water heater drain valve by turning the handle to the right (clockwise). The drain valve is located on the lower front of the water heater.
- Open the cold water supply valve to the water heater. **NOTE: The cold water supply valve must be left open when the water heater is in use.**
- To insure complete filling of the tank, allow air to exit by opening the nearest hot water faucet. Allow water to run until a constant flow is obtained. This will let air out of the water heater and the piping.
- Check all new water piping for leaks. Repair as needed.

Wiring

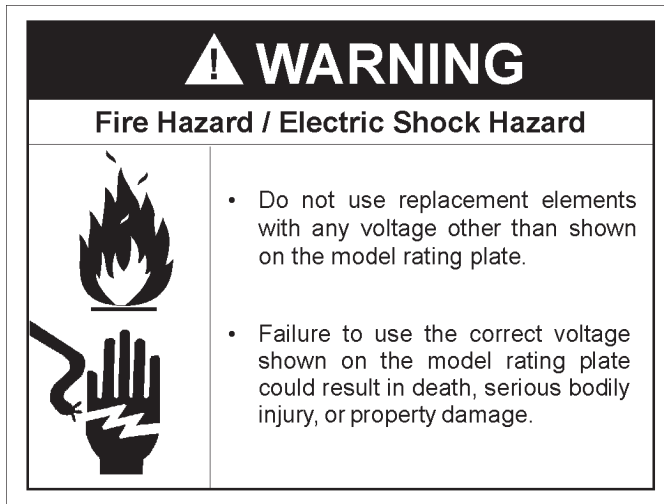

You must provide all wiring of the proper size outside of the water heater. You must obey local codes and electric company requirements when you install this wiring.

If you are not familiar with electric codes and practices, or if you have any doubt, even the slightest doubt, in your ability to connect the wiring to this water heater, obtain the service of a competent electrician. Contact your Sears salesperson to arrange for a professional electrician.

WIRING DIAGRAMS

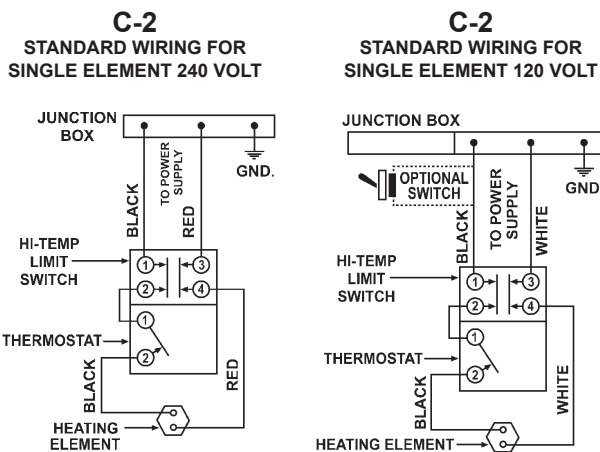

FIGURE 11.

WATER HEATERS EQUIPPED FOR ONE VOLTAGE ONLY: This water heater is equipped for one type voltage only. Check the rating plate near the bottom access panel for the correct voltage. **DO NOT** use this water heater with any voltage other than the one shown on the model rating plate. Failure to use the correct voltage can cause problems which can result in **DEATH, SERIOUS BODILY INJURY, OR PROPERTY DAMAGE.** If you have any questions or doubts consult your electric company.

If wiring from your fuse box or circuit breaker box was aluminum for your old water heater, replace it with copper wire. If you wish to reuse the existing aluminum wire, have the connection at the water heater made by a competent electrician. Contact your Sears salesperson to arrange for a professional electrician.

1. Provide a way to easily shut off the electric power when working on the water heater. This could be with a circuit breaker or fuse block in the entrance box or a separate disconnect switch.
2. Install and connect a circuit directly from the main fuse or circuit breaker box. This circuit must be the right size and have its own fuse or circuit breaker. Refer to the chart in the "Product Specifications" section for the correct size wire and fuse or circuit breaker.
3. If metal conduit is used for the grounding conductor:
 - A. The grounding electrode conductor shall be of copper, aluminum, or copperclad aluminum. The material shall be of one continuous length without a splice or joint.
 - B. Rigid metal conduit, intermediate metal conduit, or electrical metallic tubing may be used for the grounding means if conduit or tubing is terminated in fittings approved for grounding.
 - C. Flexible metal conduit or flexible metallic tubing shall be permitted for grounding if all the following conditions are met:
 - The length in any ground return path does not exceed 6 feet.
 - The circuit conductors contained therein are protected by overcurrent devices rated at 20 amperes or less.
 - The conduit or tubing is terminated in fittings approved for grounding.

For complete grounding details and all allowable exceptions, refer to the current edition of the NEC - National Electrical Code NFPA 70.

4. A standard 1/2" conduit opening has been made in the water heater junction box for the conduit connection.
5. Use wire nuts and connect the power supply wiring to the wires inside the water heater's junction box.
6. The water heater must be electrically "grounded" by the installer. A green ground screw has been provided on the water heater's junction box. Connect ground wire to this location.
7. Replace the wiring junction cover using the screw provided.

WIRING CONNECTIONS

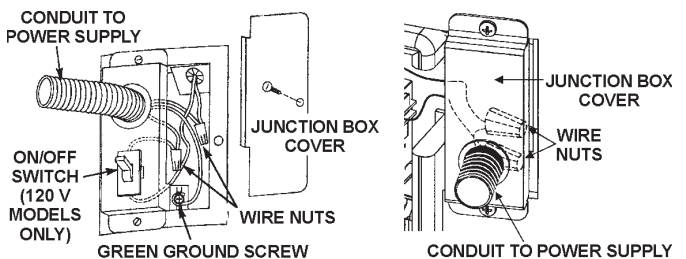
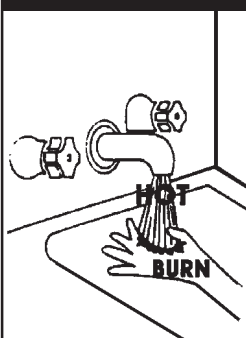

FIGURE 12.

SERVICE AND ADJUSTMENT

Temperature Regulation



⚠ DANGER Water temperature over 125°F (52°C) can cause severe burns instantly resulting in severe injury or death.

Children, the elderly, and the physically or mentally disabled are at highest risk for scald injury.

Feel water before bathing or showering.

Temperature limiting valves are available.

Read instruction manual for safe temperature setting.

HOTTER WATER CAN SCALD: Water heaters are intended to produce hot water. Water heated to a temperature which will satisfy clothes washing, dish washing, and other sanitizing needs can scald and permanently injure you upon contact. Some people are more likely to be permanently injured by hot water than others. These include the elderly, children, the infirm, or physically/mentally handicapped. If anyone using hot water in your home fits into one of these groups or if there is a local code or state law requiring a certain temperature water at the hot water tap, then you must take special precautions. In addition to using the lowest possible temperature setting that satisfies your hot water needs, some type of tempering device, such as a mixing valve, should be used at the hot water taps used by these people or at the water heater. Mixing valves are available at plumbing supply or hardware stores. Follow manufacturers instructions for installation of the valves. Before changing the factory setting of the thermostat, read the "Temperature Regulation" section in this manual.

Never allow small children to use a hot water tap, or to draw their own bath water. Never leave a child or handicapped person unattended in a bathtub or shower.

Thermostat

The thermostat of this water heater has been factory set at a position which approximates 120°F (49°C), to reduce the risk of scald injury.

The thermostat is adjustable if a different water temperature is desired. Read all warnings in this manual and on the water heating before proceeding.

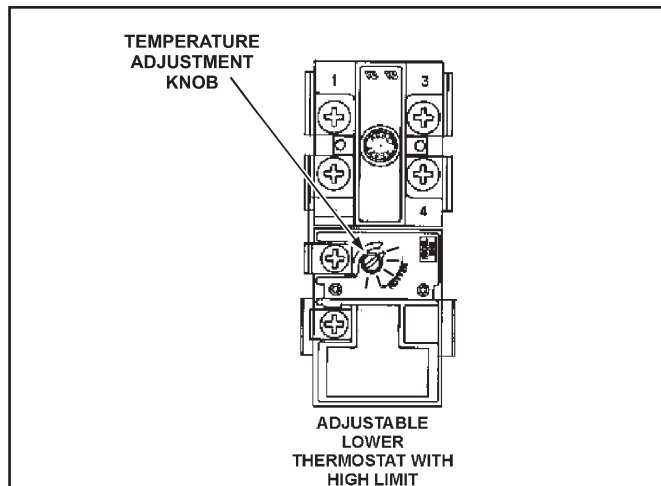

TEMPERATURE SETTINGS

It is recommended that the dial be set lower whenever possible.

Temperature Setting	Time to Produce 2nd & 3rd Degree Burns on Adult Skin
VERY HOT = approx. 160°F (71°C)	About 1/2 second
C = approx. 150°F (66°C)	About 1-1/2 seconds
B = approx. 140°F (60°C)	Less than 5 seconds
A = approx. 130°F (54°C)	About 30 seconds
HOT = approx. 120°F (49°C)	More than 5 minutes

NOTE: Water temperature range of 120°—140°F (49°-60°C) recommended by most dishwasher manufacturers.

Thermostat Adjustment

(Refer to thermostat illustrations under "Thermostat" section)



⚠ WARNING

- Before removing any access panels or servicing the water heater, make sure the electrical supply to the water heater is turned "OFF".
- Failure to do this could result in death, serious bodily injury, or property damage.

The thermostat is adjustable if a different water temperature is desired. Read all warnings in the "Temperature-Regulation" section before proceeding.

1. Turn "OFF" the electric power to the water heater at the junction box.
2. Take off the access panel and remove the insulation cap with handle.
3. The slotted adjustment (using a screwdriver) can be turned clockwise (↻) to increase the temperature setting or counter clockwise (↻) to decrease the temperature setting.
4. Replace the insulation cap with handle and access panel.
5. Turn "ON" the power supply.

Temperature-Pressure Relief Valve Operation

The temperature-pressure relief valve must be manually operated at least once a year.

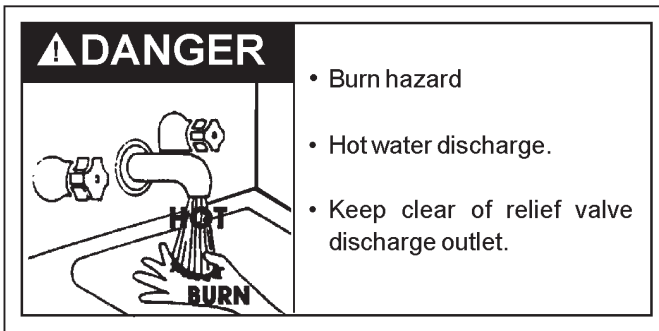

The temperature-pressure relief valve must be manually operated at least once a year. Caution should be taken to ensure that (1) no one is in front of or around the outlet of the temperature-pressure relief valve discharge line, and (2) the water manually discharged will not cause any property damage or bodily injury. The water may be extremely hot.

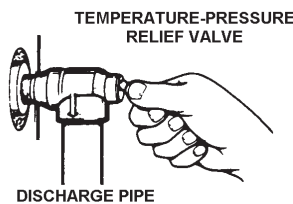

FIGURE 14.

If after manually operating the valve, it fails to completely reset and continues to release water, immediately close the cold water inlet to the water heater, follow the draining instructions, and replace the temperature-pressure relief valve with a new one.

Failure to install and maintain a new properly listed temperature-pressure relief valve will release the manufacturer from any claim which might result from excessive temperature or pressure.

If the temperature-pressure relief valve on the appliance weeps or discharges periodically, this may be due to thermal expansion. Your water heater may have a check valve installed in the water line or a water meter with a check valve. Consult your local Sears Service Center for further information. Do not plug the temperature-pressure relief valve.

Draining

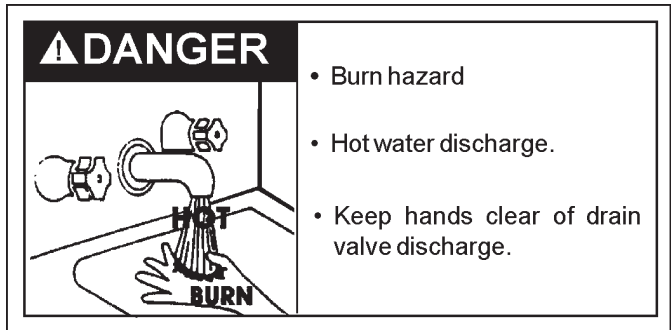

The water heater should be drained if being shut down during freezing temperatures. Also, periodic draining and cleaning of sediment from the tank may be necessary.

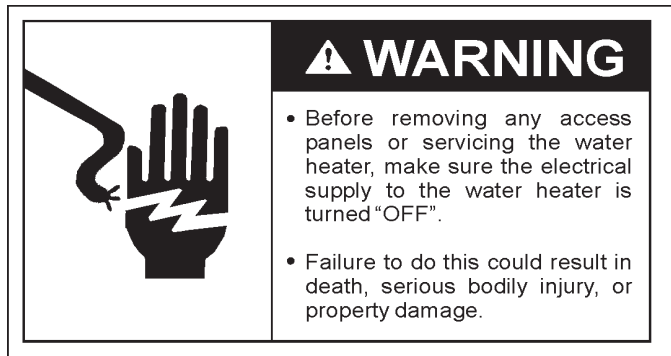

1. Before beginning turn "OFF" the electric power supply to the water heater.
2. CLOSE the cold water inlet valve to the water heater.
3. OPEN a nearby hot water faucet and leave open to allow for draining.
4. Connect a hose to the drain valve and terminate to an adequate drain or outdoors.
5. OPEN the water heater drain valve to allow for tank draining.

NOTE: If the water heater is going to be shut down and drained for an extended period, the drain valve should be left open with hose connected allowing water to terminate to an adequate drain.

6. Close the drain valve.
7. Follow "Filling the Water Heater" instructions in the "Installation Instructions" section.
8. Turn "ON" power to the water heater.



Never use this water heater unless it is completely full of water. To prevent damage to the tank and heating element, the tank must be filled with water. Water must flow from the hot water faucet before turning "ON" power.

Thermostat Removal/Replacement

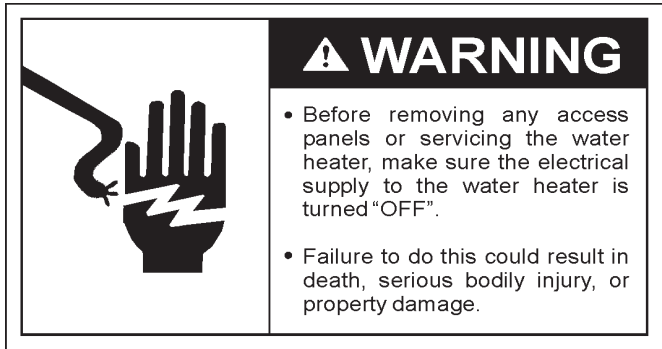

1. Turn "OFF" the electrical power to the water heater at the junction box.

HAZARD OF ELECTRICAL SHOCK! Before removing any access panels or servicing the water heater, make sure the electrical supply to the water heater is turned "OFF". Failure to do this could result in DEATH, SERIOUS BODILY INJURY OR PROPERTY DAMAGE.

2. Remove the screw(s) securing the access panel and remove panel and the insulation block.
3. Lift out the tab as shown below to unclip the terminal cover from the thermostat. The terminal cover can now be removed from the thermostat.

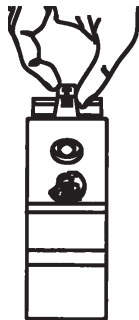

FIGURE 15.

4. Disconnect wires from thermostat.
5. Remove the thermostat from behind the thermostat bracket.
6. Place the new thermostat in the bracket making sure it fits firmly against the tank.
7. Attach the wires to the new thermostat.

NOTE: Some of the terminals may require straight-in wiring through an eye-opening. If wires are now looped, recut and strip wire 3/8" to a straight length and insert.

8. Put plastic terminal cover back in place.
9. Replace the insulation block to cover the thermostat.
10. Replace access panel, then turn the electric power on.

Element Cleaning/Replacement

To remove the element from your tank in order to clean or replace it:

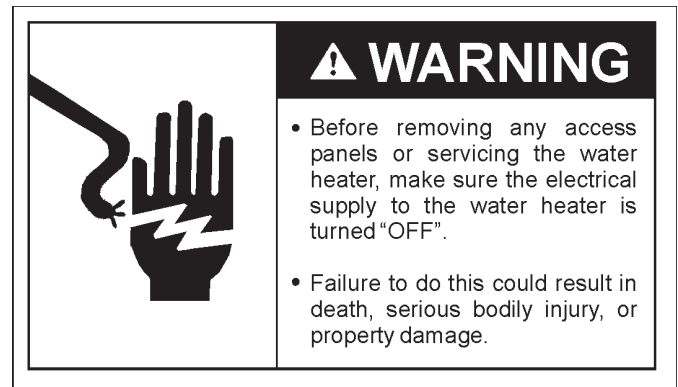

1. Before beginning turn "OFF" the electric power supply to the water heater.

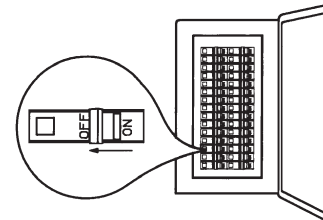

FIGURE 16.

HAZARD OF ELECTRICAL SHOCK! Before removing any access panels or servicing the water heater, make sure the electrical supply to the water heater is turned "OFF". Failure to do this could result in DEATH, SERIOUS BODILY INJURY, OR PROPERTY DAMAGE.

2. Turn off the water supply to the water heater at the water Shut-off valve or water meter.



FIGURE 17.

3. Attach a hose to the water heater drain valve and put the other end in a floor drain or outdoors. Open the water heater drain valve. Open a nearby hot water faucet which will relieve pressure in the water heater and speed draining.

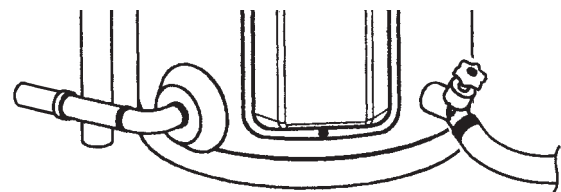

FIGURE 18.

The water passing out of the drain valve may be extremely hot. To avoid being scalded, make sure all connections are tight and that the water flow is directed away from any person.

4. Remove the screw(s) securing the access panel, and remove panel.

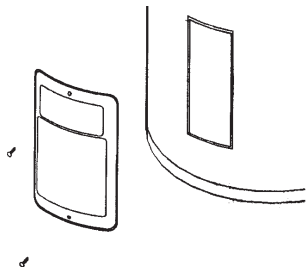

FIGURE 19.

- Remove insulation to expose the terminal cover.

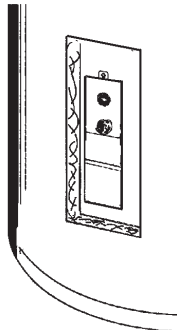

FIGURE 20.

- Lift out the tab as shown to unclip the terminal cover from the thermostat. The terminal cover can now be removed from the thermostat.

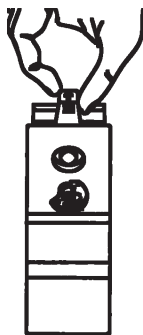

FIGURE 21.

- Disconnect the two wires on the element and unscrew the old element from the tank.

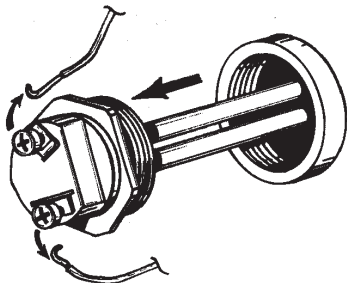

FIGURE 22.

- Clean the area around the element opening. Remove any sediment from or around the element opening, inside the tank.
- If you are cleaning the element you have removed, do so by scraping or soaking in vinegar or a de-liming solution.

⚠ WARNING	
Fire Hazard / Electric Shock Hazard	
	<ul style="list-style-type: none"> Do not use replacement elements with any voltage other than shown on the model rating plate. Failure to use the correct voltage shown on the model rating plate could result in death, serious bodily injury, or property damage.

Replacement elements must (1) be the same voltage and (2) no greater wattage than listed on the model rating plate affixed to the water heater.

- A new gasket should be used in all cases to prevent a possible water leak. (See Element Gasket in the "Parts Order List" Chart). Place the new element gasket on the thread side of the cleaned or new element and screw into tank, securing tightly using an element wrench.

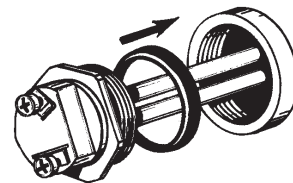

FIGURE 23.

- Close the water heater drain valve by turning the handle to the right (clockwise).
- Open the cold water supply valve to the water heater.

NOTE: The cold water supply valve must be left open when the water heater is in use.

- To insure complete filling of the tank, allow air to exit by opening the nearest hot water faucet. Allow water to run until a constant flow is obtained. This will let air out of the water heater and the piping.

CAUTION	
Improper installation and use may result in property damage.	
<ul style="list-style-type: none"> Fill tank with water before operation. 	

Never use this water heater unless it is completely full of water. To prevent damage to the tank and heating element, the tank must be filled with water. Water must flow from the hot water faucet before turning "ON" power.

- Check element for water leaks. If leakage occurs, tighten element or repeat steps 2 and 3, remove element and reposition gasket. Then repeat steps 10 through 14.
- Reconnect the two wires to the element and then check to make sure the thermostat remains firmly against the surface of the tank.



FIGURE 24.

16. Replace terminal cover on thermostat making sure that the locking tabs on the terminal cover are in place.

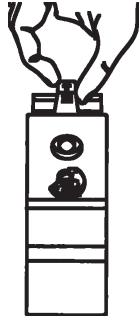

FIGURE 25.

17. Replace the insulation to cover the thermostat and the element.

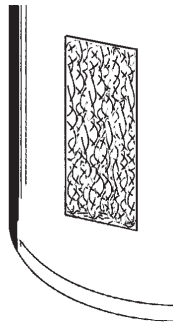

FIGURE 26.

18. Replace access panel.
19. Turn "ON" electric power to water heater.

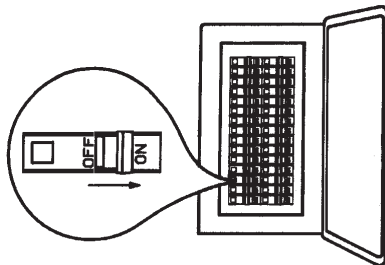



FIGURE 27.

Drain Valve Washer Replacement.

NOTE: For replacement, use a 17/32" x 13/64" x 1/8" thick washer available at your nearest hardware store. For ordering a replacement washer, refer to the "Repair Parts List" section.

- Before beginning turn "OFF" the electrical power supply to the water heater.



⚠ WARNING

- Before removing any access panels or servicing the water heater, make sure the electrical supply to the water heater is turned "OFF".
- Failure to do this could result in death, serious bodily injury, or property damage.

- Follow "Draining" instructions in the "Service and Adjustment" section.
- Turning counter clockwise, remove the hex cap below the screw handle.
- Remove the washer and put the new one in place.
- Screw the handle and cap assembly back into the drain valve and retighten using a wrench. **DO NOT OVER TIGHTEN.**
- Follow "Filling the Water Heater" instructions in the "Installation Instructions" section.
- Check for leaks.
- Turn "ON" electric power to the water heater.

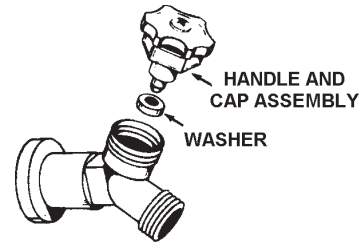

FIGURE 28.

Anode Rod Inspection

The anode rod is used to protect the tank from corrosion. Most hot water tanks are equipped with an anode rod. The submerged rod deteriorates to protect the tank. Instead of corroding the tank, water ions attack and eat away the anode rod. This does not effect the water's taste or color. The rod must be maintained to keep the tank in operating condition.

Anode deterioration depends on water conductivity, not necessarily water condition. A corroded or pitted anode rod indicates high water conductivity and should be checked and/or replaced more often than an anode rod that appears to be intact. Replacement of the depleted anode rod can extend the life of your water heater. Inspection should be conducted by calling the Sears Service Center for an authorized contractor. At a minimum, the anode(s) should be checked annually after the warranty period.

Service

Before calling for repair service, read the "Start Up Conditions" and "Operational Conditions" found in the Troubleshooting section of this manual.

If a condition persists or you are uncertain about the operation of the water heater, let a qualified person check it out.

Contact Sears Repair Services at 1-800-4-MY-HOME (1-800-469-4663).

TROUBLESHOOTING

Start Up Conditions

THERMAL EXPANSION

CAUTION

Property Damage Hazard

- Avoid water heater damage.
- Install thermal expansion tank or device if necessary.
- Contact qualified installer or service agency.

Water supply systems may, because of such events as high line pressure, frequent cut-offs, the effects of water hammer among others, have installed devices such as pressure reducing valves, check valves, back flow preventers, etc...to control these types of problems. When these devices are not equipped with an internal by-pass, and no other measures are taken, the devices cause the water system to be closed. As water is heated, it expands (thermal expansion) and closed systems do not allow for the expansion of heated water.

The water within the water heater tank expands as it is heated and increases the pressure of the water system. If the relieving point of the water heater's temperature-pressure relief valve is reached, the valve will relieve the excess pressure. **The temperature-pressure relief valve is not intended for the constant relief of thermal expansion.** This is an unacceptable condition and must be corrected.

It is recommended that any devices installed which could create a closed system have a by-pass and/or the system have an expansion tank to relieve the pressure built by thermal expansion in the water system. Thermal expansion tanks are available from Sears stores and through the Sears Service Centers. Contact the local plumbing inspector, water supplier and/or the Sears Service Center for assistance in controlling these situations.

Thermal Expansion Tank Specifications

Model Number	Tank Capacity In Gallons	Dimensions in Inches		Pipe Fitting On Tank
		Diameter	Length	
153.331020	2	8 (203 mm)	12-3/4 (323 mm)	3/4" Male

Expansion Tank Sizing Chart

Expansion Tank Capacity Needed	Inlet* Water Pressure 40-80 psi	Water Heater Capacity (Gallons)			
		6	10	20	30
		2	2	2	2

*Highest recorded inlet water pressure in a 24 hour period or regulated water pressure.

NOTE: Expansion tanks are pre-charged with a 40 psi air charge. If the inlet water pressure is higher than 40 psi, the expansion tank's air pressure must be adjusted to match that pressure, but must not be higher than 80 psi.

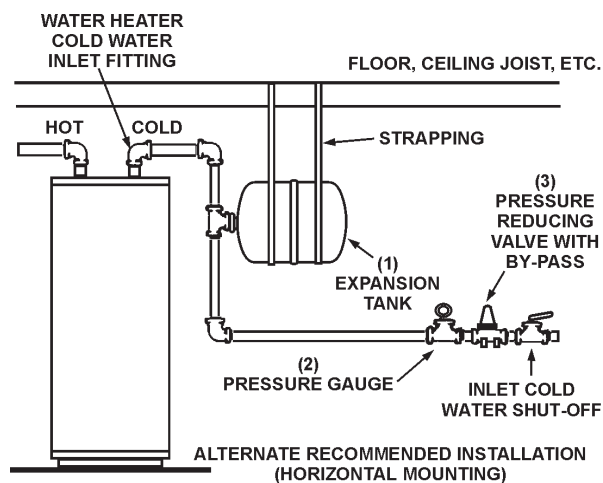
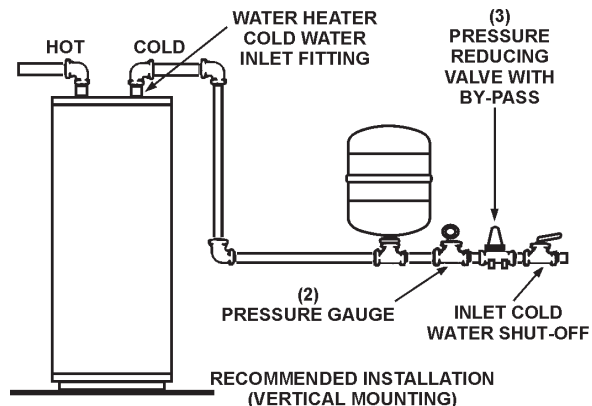

FIGURE 29.

STRANGE SOUNDS

Possible noises due to expansion and contraction of some metal parts during periods of heat-up and cool-down do not represent harmful or dangerous conditions.

Operational Conditions

SMELLY WATER

In each glass-lined water heater there is installed one anode rod (see parts section) for corrosion protection of the tank. Certain water conditions will cause a reaction between this rod and the water. The most common complaint associated with the anode rod is one of a "rotten egg smell". This odor is derived from hydrogen sulfide gas dissolved in the water. The smell is the result of four factors which must all be present for the odor to develop:

- A concentration of sulfate in the supply water.
- Little or no dissolved oxygen in the water.
- A sulfate reducing bacteria within the water heater. (This harmless bacteria is non-toxic to humans.)
- An excess of active hydrogen in the tank. This is caused by corrosion protective action of the anode.

Smelly water may be eliminated or reduced in some water heater models by replacing the anode rod(s) with one of less active material, and the chlorinating the water heater tank and all water lines. Contact the local Sears Service Center for further information concerning an Anode Replacement Kit #9001453 and this Chlorination Treatment. **Anode replacement and chlorination of the tank are not covered by the water heater's limited warranty.**

If smelly water persists, after anode replacement and chlorination treatment, you should consider chlorinating or aerating your water supply.

Do not remove the anode leaving the tank unprotected. By doing so, all warranty on the water heater tank is voided.

“AIR” IN HOT WATER FAUCETS

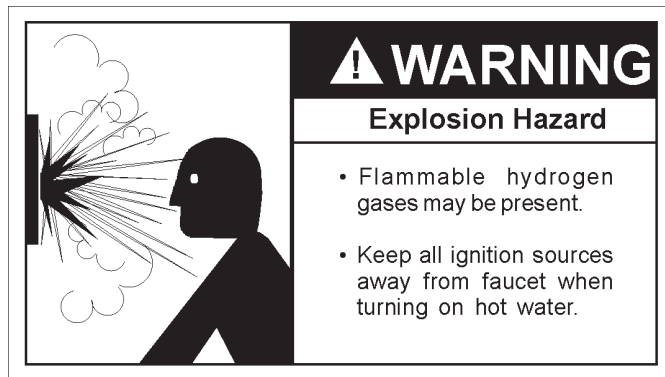

HYDROGEN GAS: Hydrogen gas can be produced in a hot water system that has not been used for a long period of time (generally two weeks or more). Hydrogen gas is extremely flammable and explosive. To prevent the possibility of injury under these conditions, we recommend the hot water faucet be opened for several minutes at the kitchen sink before any electrical appliances which are connected to the hot water system are used (such as a dishwasher or washing machine). If hydrogen gas is present, there will probably be an unusual sound similar to air escaping through the pipe as the hot water faucet is opened. There must be no smoking or open flame near the faucet at the time it is open.

RUMBLING NOISE

In some water areas, scale or mineral deposits will build up on your heating elements. This buildup will cause a rumbling noise. Follow “Element Cleaning/Replacement” instructions to clean and replace the elements.

HIGH TEMPERATURE SHUT OFF SYSTEM

The water heater has a high limit shut off system with a reset button located on the thermostat.

Follow the resetting instructions which refer to the high limit behind the access panel.

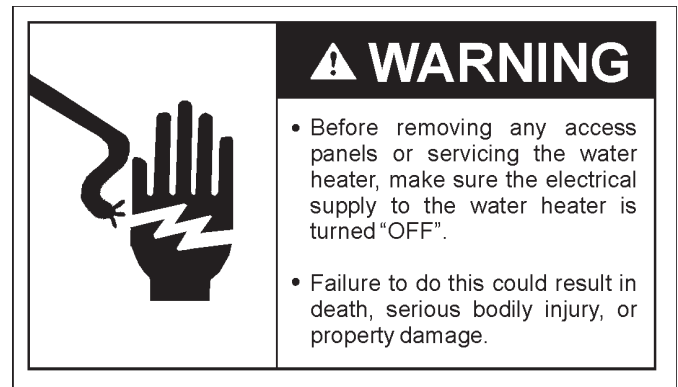

1. Before beginning, turn “OFF” electrical power supply to the water heater.

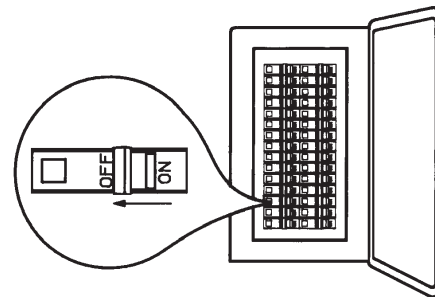

FIGURE 30.

2. Remove the screw(s) securing the access panel and remove panel.
3. Remove the insulation.
4. Reset the high limit by pushing in the red button marked “RESET”.

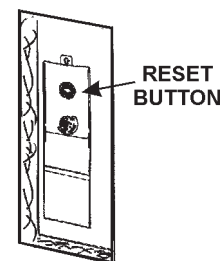

FIGURE 31.

5. Replace the insulation so that it completely covers the thermostat and element.
6. Replace the access panel.
7. Turn “ON” electric power to the water heater.

If the high limit must be reset again, call Sears Service Department to find out why high limit turned “OFF” the electric power.

NOT ENOUGH OR NO HOT WATER

1. In a new installation, the water heater may not be properly connected. Make sure the cold water supply valve is open. Review and check piping installation. Make sure that the cold water line is connected to the cold water inlet to the water heater and the hot water line to the hot water outlet on the water heater.
2. Make sure the electrical supply to your water heater is "ON".
3. Check for loose or blown fuses in your water heater circuit. Circuit breakers weaken with age and may not handle their rated load and should be replaced.
4. Make certain the disconnect switch, if used, is in the "ON" position.
5. Check to see the electric service to your house has not been interrupted. If this is the case, contact the electric company.
6. Is the thermostat set to the desired temperature? See "Temperature Regulation" section.

7. If you had experienced very hot water and now no hot water, the problem may be due to the high temperature shut off system. See "High Temperature Shut Off System" in the "Troubleshooting" section.
8. During very cold weather, the incoming water will also be colder and it will require a longer time to become heated.
9. The hot water usage may exceed the capacity of the water heater. If so, wait for water heater to recover after abnormal demand. Also examine pipes and faucets for possible water leaks.
10. If you can not determine the problem, then call the Sears Service Department.

WATER IS TOO HOT

Adjust the thermostat to a lower setting. See the "Temperature Regulation" section.

LEAKAGE CHECKPOINTS

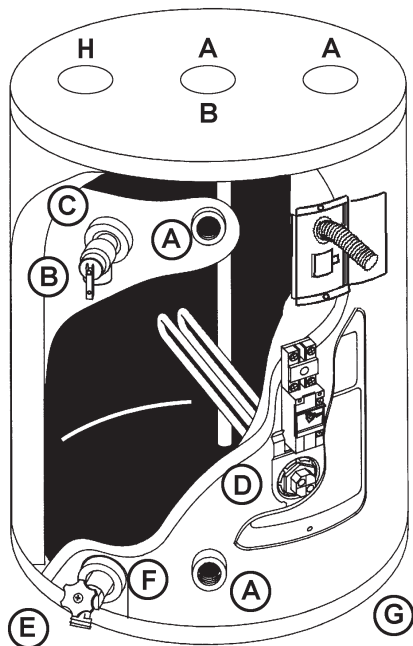
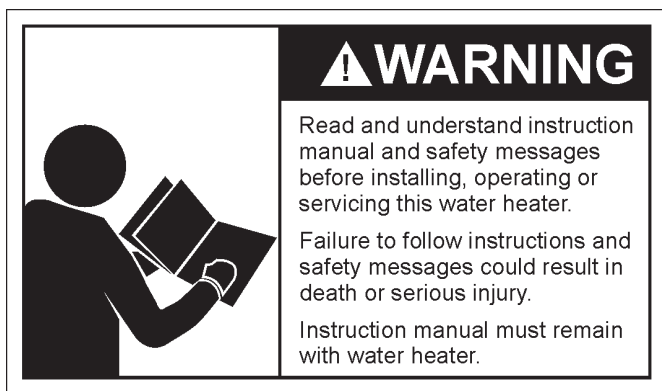

FIGURE 32.

Use this guide to check a "Leaking" water heater. Many suspected "Leakers" are not leaking tanks. Often the source of the water can be found and corrected.

If you are not thoroughly familiar with electric codes, the water heater, and safety practices, contact your local Sears Service Center to check the water heater.



Read this manual first. Then before checking the water heater make sure the electric supply has been turned "OFF", and never turn the electric supply "on" before the tank is completely full of water.

CAUTION

Improper installation and use may result in property damage.

- Fill tank with water before operation.

Never use this water heater unless it is completely full of water. To prevent damage to the tank and heating element, the tank must be filled with water. The water must flow from the hot water faucet before turning "ON" power.

- A. *Condensation may be seen on pipes in humid weather or pipe connections may be leaking.
- B. Small amounts of water from the temperature-pressure relief valve may be due to thermal expansion or high water pressure in your area.
- C. *The temperature-pressure relief valve may be leaking at the tank fitting.
- D. The element may be leaking at the tank fitting.
- E. The element may be leaking at the tank fitting.
- F. *The drain valve may be leaking at the tank fitting.
- G. Water in the water heater bottom or on the floor may be from condensation, loose connections or the temperature-pressure relief valve. DO NOT replace the water heater until a full inspection of all possible water sources is made and necessary corrective steps taken.
- H. Check anode rod fitting for leak.

Note: Models with optional fitting locations on top, check for leaks at plugs.

Leakage from other appliances, water lines, or ground seepage should also be checked.

Note: To check where threaded portion enters tank, insert cotton swab between jacket opening and fitting. If cotton is wet, follow "Draining" instructions in the "Service and Maintenance" section and then remove fitting. Put pipe dope or teflon tape on the threads and replace. Then follow "Filling the Water Heater" instructions in the "Installation Instructions" section.

REPAIR PARTS LIST

KENMORE THE ECONOMIZER™ 6 COMPACT ELECTRIC WATER HEATERS

MODEL NO'S	
153.316040	6 Gallon
153.316050	10 Gallon
153.316060	19 Gallon Short
153.316070	19.9 Gallon Tall
153.326060	19 Gallon 240 V. Short
153.326070	19.9 Gallon 240 V Tall

Note: Illustration is used to reference parts of compact models only - Actual locations of components on water heater may vary from model to model.

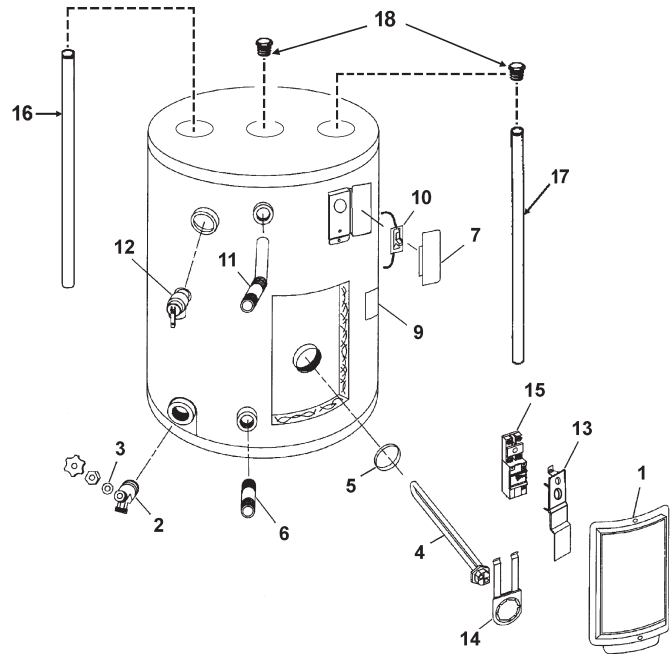

	6	10	19 (20S)	19.9 (20T)	19 (20S)	19.9 (20T)
Description	153.316040	153.316050	153.316060	153.316070	153.326060	153.326070
1. Access Door	9006293	9006293	9006293	9006293	9006293	9006293
2. Drain Valve	9000058	9000058	9000058	9000058	9000058	9000058
3. Drain Valve Washer 17/32"x13/64"x1/8 Tk	9001584	9001584	9001584	9001584	9001584	9001584
4. Element	9000139	9000139	9000139	9000139	9000133	9000133
5. Element Gasket	9000308	9000308	9000308	9000308	9000308	9000308
6. Inlet Nipple - 2-1/2"	9003976	9003976	9003976	9003976	9003976	9003976
7. Junction Box Cover	9001327	9001327	9001327	9001327	9001327	9001327
8. Manual #	185775-000	185775-000	185775-000	185775-000	185775-000	185775-000
9. Model Rating Plate +	184227-000	184227-000	184227-000	184227-000	184227-000	184227-000
10. ON/OFF Switch	9000340	9000340	9000340	9000340	-----	-----
11. Outlet Nipple	9001494	9001494	9006294	9001494	9006294	9001494
12. Temperature-Pressure Relief Valve - 2"	9000728	9000728	9000728	9000728	9000728	9000728
13. Terminal Cover	9002438	9002438	9002438	9002438	9002438	9002438
14. Thermostat Bracket	9006298	9006298	9006298	9006298	9006298	9006298
15. T'stat W/Hi Limit	9002327	9002327	9002327	9002327	9002327	9002327
16. Anode Rod	9003942	9003942	9003944	9003944	9003944	9003944
17. Inlet Tube	9006297	-----	9006296	9003663	9006296	9003663
18. Plug	9001437	9001437	9001437	9001437	9001437	9001437

** Also available at most hardware stores. † Replaced only on return of damaged plate. # Not illustrated.

Now that you have purchased this water heater, should a need ever exist for repair parts or service, simply contact any Sears Service Center or call 1-800-4-MY-HOME (1-800-469-4663). Be sure to provide all pertinent facts when you call or visit.

All Parts listed may be ordered from any Sears Service Center and by calling 1-800-366-PART (1-800-366-7278).

If the parts you need are not stocked locally, your order will be electronically transmitted to a Sears Repair Parts Distribution Center for handling.

The model number of the water heater will be found on the model rating plate located near the access panel.

WHEN ORDERING REPAIR PARTS, ALWAYS GIVE THE FOLLOWING INFORMATION:

- Model Number • Part Number
- Serial Number
- Part Description

THIS IS A REPAIR PARTS LIST, NOT A PACKING LIST.

REPAIR PARTS LIST

KENMORE THE ECONOMIZER™ 6 COMPACT ELECTRIC WATER HEATERS

MODEL NO'S

153.316331	30 Gallon
153.326331	30 Gallon 240 V

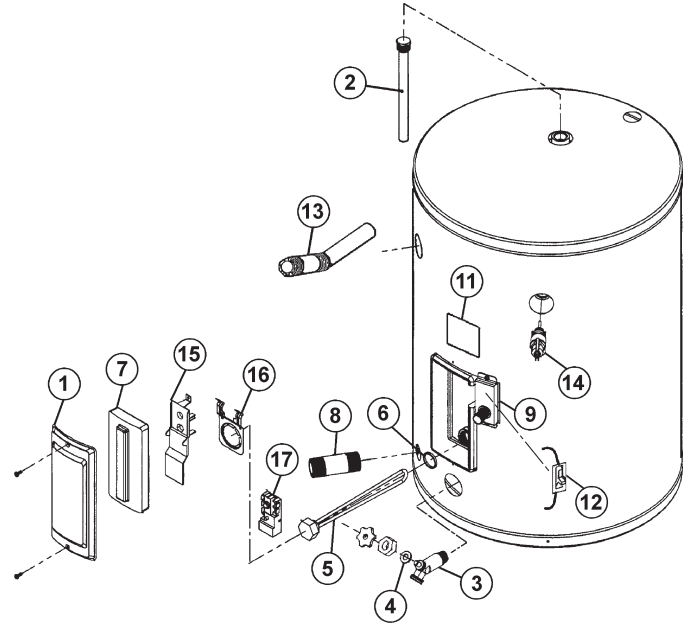

Key No.	Part Description	Model Numbers	
		153.316331	153.326331
1	Access Panel	9003900	9003900
2	Anode Rod	9003944	9003944
3	Drain Valve	9000058	9000058
4	Drain Valve Washer (17/32" x 13/64" x 1/8" Thick)**	9001584	9001584
5	Element	9000139	9000133
6	Element Gasket	9000308	9000308
7	Element Insulation Cap	9003723	9003723
8	Inlet Water Nipple	9002298	9002298
9	Junction Box Cover	9001327	9001327
10	Manual#	185775-000	185775-000
11	Model Rating Plate†	184227-001	184227-000
12	ON/OFF Switch	9000340	-----
13	Outlet Nipple	9001494	9001494
14	Temperature-Pressure Relief Valve	9000728	9000728
15	Terminal Cover	9002438	9002438
16	Thermostat Bracket	9006295	9006295
17	Thermostat w/4 Terminal Hi Limit	9002327	9002327

** Also available at most hardware stores. † Replaced only on return of damaged plate. # Not illustrated.

Now that you have purchased this water heater, should a need ever exist for repair parts or service, simply contact any Sears Service Center or call 1-800-4-MY-HOME (1-800-469-4663). Be sure to provide all pertinent facts when you call or visit.

All Parts listed may be ordered from any Sears Service Center and by calling 1-800-366-PART (1-800-366-7278).

If the parts you need are not stocked locally, your order will be electronically transmitted to a Sears Repair Parts Distribution Center for handling.

The model number of the water heater will be found on the model rating plate located near the access panel.

WHEN ORDERING REPAIR PARTS, ALWAYS GIVE THE FOLLOWING INFORMATION:

- Model Number • Part Number
- Serial Number
- Part Description

THIS IS A REPAIR PARTS LIST, NOT A PACKING LIST.

6 YEAR LIMITED WARRANTY ON WATER HEATER

For six years from the date of purchase, if this water heater is installed and operated in a single-family home in accordance with the owner's manual instructions and all local applicable plumbing codes, Sears will supply a free water heater for one that develops a leak.

For the second through sixth year from the purchase date, you must pay the labor cost for installation of water heater.

For commercial, institutional, industrial or residential use by two or more families, the above limited warranty is only for two years. During the second year you must pay the labor cost for water heater installation.

1 YEAR EXCLUSIVE KENMORE LABOR WARRANTY

For the first year from the date of purchase, Sears will, free of charge, supply and install new water heater parts for defective ones or a new water heater for one that develops a leak.

WARRANTY SERVICE

To obtain warranty service, call 1-800-4-MY-HOME® (1-800-469-4663). This warranty applies only while this product is in use in the United States.

This warranty gives you specific legal rights, and you may also have other rights which vary from state to state.

SEARS, ROEBUCK AND CO., Dept. 817 WA, Hoffman Estates, IL 60179

The price of your water heater does not include a free checkup service call. On water heater installations arranged by Sears, Sears warrants the installation.

A charge will be made on service calls due to poor or incomplete installation. These include:

- a. Adjusting thermostat c. Leaks in pipes or fittings b. Condensation

MASTER PROTECTION AGREEMENTS

Congratulations on making a smart purchase. Your new Kenmore® product is designed and manufactured for years of dependable operation. But like all products, it may require preventive maintenance or repair from time to time. That's when having a Master Protection Agreement can save you money and aggravation.

Purchase a Master Protection Agreement now and protect yourself from unexpected hassle and expense.

The Master Protection Agreement also helps extend the life of your new product. Here's what's included in the Agreement:

- **Expert Service** by our 12,000 professional repair specialist.
- **Unlimited service and no charge** for parts and labor on all covered repairs.
- **"No-lemon" guarantee** - replacement of your covered product if four or more product failures occur within twelve months.
- **Product replacement** if your covered product can't be fixed.
- **Annual Preventive Maintenance Check** at your request - no extra charge.

- **Fast help by phone** - phone support from a Sears technician on products requiring in-home repair, plus convenient repair scheduling.
- **Power surge protection** against electrical damage due to power fluctuations.
- **Rental reimbursement** if repair of your covered product takes longer than promised.

Once you purchase the Agreement, a simple phone call is all that it takes for you to schedule service. You can call anytime day or night, or schedule a service appointment on-line.

Sears has over 12,000 professional repair specialists, who have access to over 4.5 million quality parts and accessories. That's the kind of professionalism you can count on to help prolong the life of your new purchase for years to come. Purchase your Master Protection Agreement today!

Some limitations and exclusions apply. For prices and additional information call 1-800-827-6655.

SEARS INSTALLATION SERVICE

For Sears professional Installation of home appliances, garage door openers, water heaters, and other major home items, in the U.S.A., call **1-800-4-MY-HOME®**.

For in-home major brand repair service

Call 24 hours a day, 7 days a week (U.S.A. and Canada)

1-800-4-MY-HOME®

(1-800-469-4663)

SEARS

www.sears.com

The model number of your water heater is found on the model rating plate on the front of the water heater.

Sears, Roebuck and Co., Hoffman Estates, IL 60179 U.S.A

Free Manuals Download Website

<http://myh66.com>

<http://usermanuals.us>

<http://www.somanuals.com>

<http://www.4manuals.cc>

<http://www.manual-lib.com>

<http://www.404manual.com>

<http://www.luxmanual.com>

<http://aubethermostatmanual.com>

Golf course search by state

<http://golfingnear.com>

Email search by domain

<http://emailbydomain.com>

Auto manuals search

<http://auto.somanuals.com>

TV manuals search

<http://tv.somanuals.com>