



Owners Manual

FOR POTABLE WATER
HEATING ONLY
NOT SUITABLE FOR
SPACE HEATING

Model No.

153.317020 2 Gal.



POINT OF USE ELECTRIC WATER HEATER

- Safety Instructions
- Installation
- Operation
- Care and Maintenance
- Troubleshooting
- Parts List



LISTED

Caution:
Read and Follow
All Safety Rules and
Operating Instructions
Before First Use of
This Product.

Save this Manual for Future Reference.



GAMA certification applies to all residential electric water heaters with capacities of 20 to 120 Gallons. Input rating of 12 Kw or less at a voltage no greater than 250 V.

⚠WARNING

READ THE GENERAL SAFETY SECTION BEGINNING ON INSIDE COVER AND THEN THIS ENTIRE MANUAL BEFORE INSTALLING OR OPERATING THIS WATER HEATER.

Sears, Roebuck and Co., Hoffman Estates, IL 60179 U.S.A.

Safety Precautions

⚠ WARNING

Improper installation, adjustment, alteration, service or maintenance can cause **DEATH, SERIOUS BODILY INJURY, OR PROPERTY DAMAGE**. Refer to this manual for assistance or consult your local Sears Service Center for further information.

⚠ WARNING

At the time of manufacture this water heater was provided with a combination temperature-pressure relief valve certified by a nationally recognized testing laboratory that maintains periodic inspection of production of listed equipment or materials, as meeting the requirements for Relief Valves and Automatic Gas Shutoff Devices for Hot Water Supply Systems, and the current edition of ANSI Z21.22 • CSA 4.4 and the code requirements of ASME. If replaced, the valve must meet the requirements of local codes, but not less than a combination temperature and pressure relief valve certified as meeting the requirements for Relief Valves and Automatic Gas Shutoff Devices for Hot Water Supply Systems, ANSI Z21.22 • CSA 4.4 by a nationally recognized testing laboratory that maintains periodic inspection of production of listed equipment or materials.

The valve must be marked with a maximum set pressure not to exceed the marked hydrostatic working pressure of the water heater (150 lbs./sq. in.) and a discharge capacity not less than the water heater input rate as shown on the model rating plate. (Electric heaters - watts divided by 1000 x 3412 equal BTU/Hr. rate.)

Your local jurisdictional authority, while mandating the use of a temperature-pressure relief valve complying with ANSI Z21.22 • CSA 4.4 and ASME, may require a valve model different from the one furnished with the water heater.

Compliance with such local requirements must be satisfied by the installer or end user of the water heater with a locally prescribed temperature-pressure relief valve installed in the designated opening in the water heater in place of the factory furnished valve.

For safe operation of the water heater, the relief valve must not be removed from its designated opening or plugged.

The temperature-pressure relief valve must be installed directly into the fitting of the water heater designated for the relief valve. Position the valve downward and provide tubing so that any discharge will exit only within 6 inches above, or at any distance below the structural floor. Be certain that no contact is made with any live electrical part. The discharge opening must not be blocked or reduced in size under any circumstances. Excessive length, over 30 feet, or use of more than four elbows can cause restriction and reduce the discharge capacity of the valve.

No valve or other obstruction is to be placed between the relief valve and the tank. Do not connect tubing directly to discharge drain unless a 6" air gap is provided. To prevent bodily injury, hazard to life, or property damage, the relief valve must be allowed to discharge water in quantities should circumstances demand. If the discharge pipe is not connected to a drain or other suitable means, the water flow may cause property damage.

The Discharge Pipe:

- Must not be smaller in size than the outlet pipe size of the valve, or have any reducing couplings or other restrictions.
- Must not be plugged or blocked.
- Must be of material listed for hot water distribution.
- Must be installed so as to allow complete drainage of both the temperature-pressure relief valve, and the discharge pipe.
- Must terminate at an adequate drain.
- Must not have any valve between the relief valve and tank.

⚠ WARNING

HAZARD OF ELECTRICAL SHOCK! Before removing any access panels or servicing the water heater, make sure the electrical supply to the water heater is turned "OFF". Failure to do this could result in **DEATH, SERIOUS BODILY INJURY, OR PROPERTY DAMAGE**.

⚠ WARNING

HOTTER WATER CAN SCALD: Water heaters are intended to produce hot water. Water heated to a temperature which will satisfy space heating, clothes washing, dish washing, and other sanitizing needs can scald and permanently injure you upon contact. Some people are more likely to be permanently injured by hot water than others. These include the elderly, children, the infirm, or physically/mentally handicapped. If anyone using hot water in your home fits into one of these groups or if there is a local code or state law requiring a certain temperature water at the hot water tap, then you must take special precautions. In addition to using the lowest possible temperature setting that satisfies your hot water needs, a means such as a mixing valve, shall be used at the hot water taps used by these people or at the water heater. Mixing valves are available at plumbing supply or hardware stores. Follow manufacturers instructions for installation of the valves. Before changing the factory setting on the thermostat, read the "Temperature Regulation" section in this manual.

⚠ WARNING

WATER HEATERS EQUIPPED FOR ONE VOLTAGE ONLY: This water heater is equipped for one type voltage only. Check the rating plate near the bottom access panel for the correct voltage. **DO NOT** use this water heater with any voltage other than the one shown on the model rating plate. Failure to use the correct voltage can cause problems which can result in **DEATH, SERIOUS BODILY INJURY, OR PROPERTY DAMAGE**. If you have any questions or doubts consult your electric company.

⚠ WARNING

INSULATING JACKETS: When installing an external water heater insulation jacket on an electric water heater:

- DO NOT** cover the temperature-pressure relief valve.
- DO NOT** put insulation over the access covers or any access areas.
- DO NOT** remove operating instructions, and safety related warning labels and materials affixed to the water heater.
- DO** obtain new warning and instruction labels from Sears for placement on the jacket directly over the existing labels.

⚠ WARNING

Do not use this appliance if any part of it has been under water. An electrical short or malfunction could occur. The water heater should be replaced.

⚠ CAUTION

WATER HEATERS EVENTUALLY LEAK: Installation of the water heater must be accomplished in such a manner that if the tank or any connections should leak, the flow of water will not cause damage to the structure. When such locations cannot be avoided, a suitable drain pan should be installed under the water heater. Drain pans are available at your local Sears Store. Such a drain pan must be piped to an adequate drain.

Table of Contents

Safety Precautions.....	2
Table of Contents.....	3
Customer Responsibilities.....	4
Product Specifications.....	4
Materials and Basic Tools Needed.....	5
Materials Needed.....	5
Basic Tools.....	5
Installation Instructions	
Removing the Old Water Heater.....	6
Facts to Consider About the Location.....	7
Optional Wall Mounting.....	7, 8
Water Piping.....	8
Temperature-Pressure Relief Valve.....	9
Filling the Water Heater.....	10
Optional Cord Set.....	10
Wiring Diagrams.....	10
Wiring.....	11
Installation Checklist.....	12
Service and Adjustment	
Temperature Regulation.....	13
Thermostats.....	13
Temperature Settings.....	13
Thermostat Adjustment.....	13
Temperature-Pressure Relief Valve Operation.....	14
Draining.....	14
Element Cleaning/Replacement.....	15-17
Drain Valve Washer Replacement.....	17
Service.....	17
Troubleshooting Guide	
Start Up Conditions.....	18
Thermal Expansion.....	18
Strange Sounds.....	18
Operational Conditions.....	19, 20
Smelly Water.....	19
“Air” in Hot Water Faucets.....	19
Rumbling Noise.....	19
High Temperature Shut Off System.....	19, 20
Not Enough or No Hot Water.....	20
Water Is Too Hot.....	20
Leakage Checkpoints.....	21
Parts Order List.....	22, 23
Warranty.....	24

Customer Responsibilities

Thank You for purchasing a Sears water heater. Properly installed and maintained, it should give you years of trouble free service. If you should decide that you want the new water heater professionally installed by Sears call the local Service Center or any Sears store. They will arrange for prompt, quality installation by Sears authorized contractors.

Abbreviations Found In This Instruction Manual

U.L. - Underwriters Laboratories Inc., 333 Pfingsten Rd., Northbrook, IL 60062

NEC - National Electrical Code

ANSI - American National Standards Institute

- Read the "Safety Precautions" section, page 2 of this manual first and then the entire manual carefully. If you don't follow the safety rules, the water heater will not operate properly. It could cause DEATH, SERIOUS BODILY INJURY AND/OR PROPERTY DAMAGE.

This manual contains instructions for the installation, operation, and maintenance of this electric water heater. It also contains warnings throughout the manual that you must read and be aware of. All warnings and all instructions are essential to the proper operation of the water heater and your safety. Since we cannot put everything on the first few pages, READ THIS ENTIRE MANUAL BEFORE ATTEMPTING TO INSTALL OR OPERATE THE WATER HEATER.

- The installation must conform with the instructions in this manual; electric company rules; and Local Codes, or in the absence of Local Codes, with the current edition of the NEC, National Electrical Code NFPA 70. This publication is available from your local government or public library or electric company or by writing Underwriters Laboratories Inc., 333 Pfingsten Road, Northbrook, IL 60062.
- If after reading this manual you have any questions or do not understand any portion of the instructions, call Sears Service Center.
- Carefully plan the place where you are going to put the water heater. Correct electrical wiring and connections are very important in preventing death from possible electrical shock and fires. Examine the location to ensure the water heater complies with the "Facts to Consider About the Location" section.
- For California installation this water heater must be braced, anchored, or strapped to avoid falling or moving during an earthquake. See instructions for correct installation procedures. Instructions may be obtained from your local dealer, wholesaler, public utilities or California Office of the State Architect, 400 P Street, Sacramento, CA 95814.
- Massachusetts Code requires this water heater to be installed in accordance with Massachusetts 248-CMR 2.00: State Plumbing Code and 248-CMR 5.00.

Product Specifications

MODEL NUMBER	TANK CAPACITY IN GALLONS	DIMENSIONS IN INCHES		RECOVERY RATE GALS. PER HOUR @ 90°F. RISE	ELEMENT WATTAGE 120 Volt	MINIMUM WIRE SIZE* (GAUGE)	MAXIMUM FUSE OR CIRCUIT BREAKER SIZE (AMPS)
		DIAMETER	HEIGHT				
153.317020	2	10"	12 3/4"	7	1440	12	20

*Wiring size based on standard 60°C copper wire. If distance from fuse box to water heater is more than 90 feet, refer to your local electrical code.

Materials and Basic Tools Needed

Materials Needed

To simplify the installation Sears has available the installation parts shown below. You may or may not need all of these materials, depending on your type of installation.

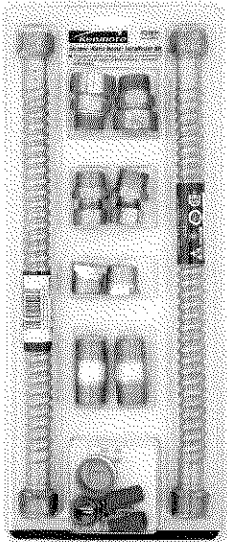

WATER HEATER INSTALLATION KIT WITH FLEXIBLE CONNECTORS FOR 3/4" OR 1/2" THREADED OR COPPER PLUMBING

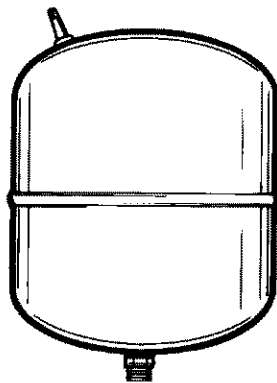

EXPANSION TANKS FOR THERMAL EXPANSION CONDITIONS AVAILABLE IN 2 GALLON CAPACITY THROUGH LOCAL SEARS SERVICE CENTERS

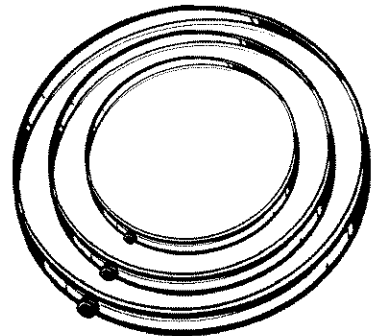

DRAIN PANS AVAILABLE IN 20" DIAMETER FOR WATER HEATERS HAVING A DIAMETER 18" OR LESS, 24" DIAMETER FOR WATER HEATERS HAVING A DIAMETER 22" OR LESS AND AVAILABLE IN 28" DIAMETER FOR WATER HEATERS HAVING A DIAMETER 26" OR LESS

Basic Tools

You may or may not need all of these tools, depending on your type of installation. These tools can be purchased at your local Sears store.

- Pipe Wrench (2) 14"
- Screwdriver
- 6 Foot Tape or Folding Rule
- Garden Hose
- Drill
- Pipe Dope or Teflon Tape



GARDEN HOSE



6 FOOT TAPE

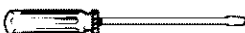

SLOT-HEAD SCREWDRIVER

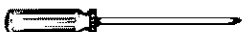

PHILLIPS SCREWDRIVER

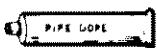

PIPE DOPE (SQUEEZE TUBE)



**roll of teflon tape
(Use only on water connections)**



PIPE WRENCH

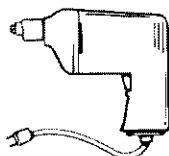

DRILL

ADDITIONAL TOOLS NEEDED WHEN SWEAT SOLDERING

- Tubing Cutters or Hacksaw
- Propane Torch
- Soft Solder
- Solder Flux
- Emery Cloth
- Wire Brushes

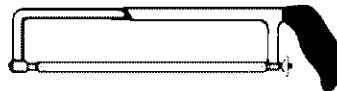

HACKSAW

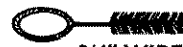

3/4" WIRE BRUSH

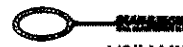

1/2" WIRE BRUSH



ROLL OF LEAD FREE SOFT SOLDER



PROPANE TORCH



ROLL OF EMERY CLOTH



SOLDER FLUX

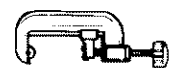

TUBING CUTTER

Installation Instructions

Removing the Old Water Heater

- ① Turn "OFF" electrical supply to the water heater.

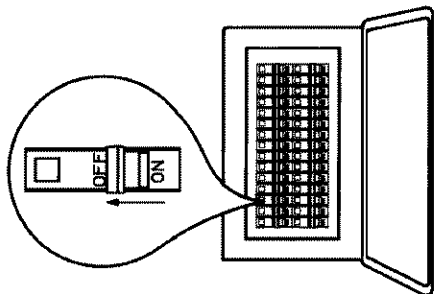

- ② Turn "OFF" the water supply to the water heater at the water shutoff valve or water meter.

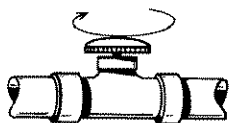

- ③ Attach a hose to the water heater drain valve and put the other end in a floor drain or outdoors. Open the water heater drain valve. Open a nearby hot water faucet which will relieve pressure in the water heater and speed draining.

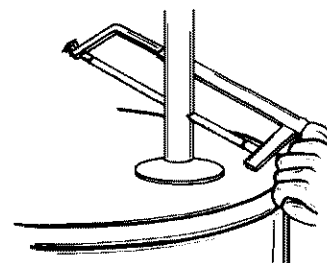
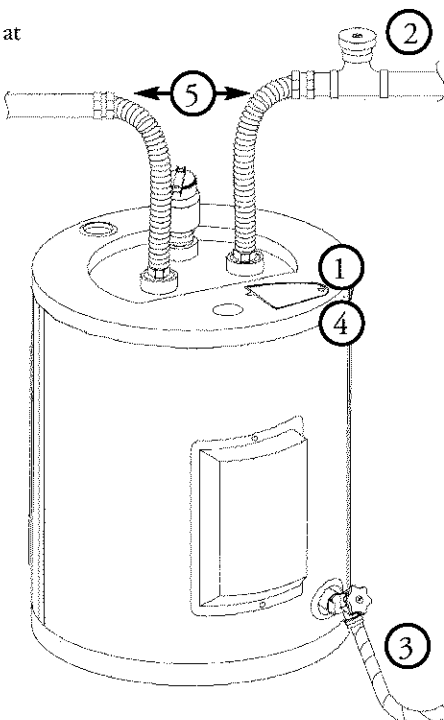
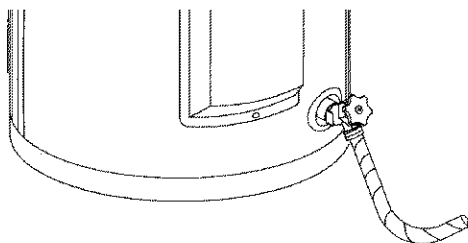

- ⑤ a. If you have copper piping to the water heater, the two copper water pipes can be cut with a hacksaw approximately 4" away from where they connect to the water heater. This will avoid cutting off the pipes too short. Additional cuts can be made later if necessary. Disconnect the temperature-pressure relief valve drain line. When the water heater is drained, disconnect the hose from the drain valve. Close the drain valve. The water heater is now completely disconnected and ready to be removed.
- ⑤ b. If you have galvanized pipe to the water heater, loosen the two galvanized pipes with a pipe wrench at the union in each line. Also disconnect the piping remaining to the water heater. These pieces should be saved since they may be needed when reconnecting the new water heater. Disconnect the temperature-pressure relief valve drain line. When the water heater is drained, disconnect the hose from the drain valve. Close the drain valve. The water heater is now completely disconnected and ready to be removed.

⚠ WARNING

The water passing out of the drain valve may be extremely hot. To avoid being scalded, make sure all connections are tight and that the water flow is directed away from any person.

- ④ Check again to make sure the electrical supply is turned "OFF" to the water heater. Then unplug the water heater (cord set) or disconnect the electrical supply connection from the water heater junction box.

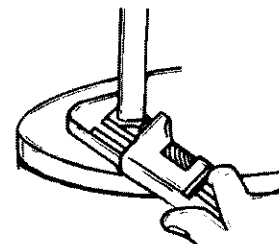
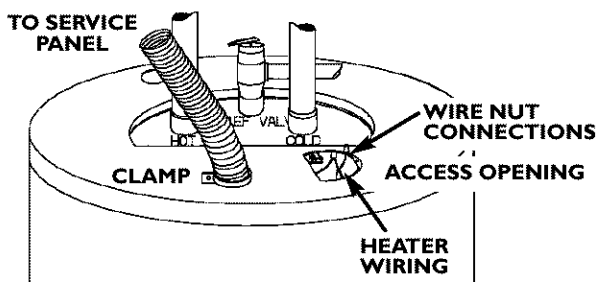

⚠ CAUTION

Mineral buildup or sediment may have accumulated in the old water heater. This causes the water heater to be much heavier than normal and this residue, if spilled out, could cause staining.

Installation Instructions (cont'd)

Facts to Consider About the Location

You should carefully choose an indoor location for the new water heater, because the placement is a very important consideration for the safety of the occupants in the building and for the most economical use of the appliance. This water heater is not intended for outdoor installation.

Whether replacing an old water heater or putting the water heater in a new location, the following critical points must be observed.

- The location selected should be indoors as close to and as centralized with the water piping system as possible. This water heater, as well as all water heaters, will eventually leak. Do not install without adequate drainage provisions where water flow will cause damage.

⚠ CAUTION
WATER HEATERS EVENTUALLY LEAK: Installation of the water heater must be accomplished in such a manner that if the tank or any connections should leak, the flow of water will not cause damage to the structure. When such locations cannot be avoided, a suitable drain pan should be installed under the water heater. Drain pans are available at your local Sears stores. Such a drain pan must be piped to an adequate drain.

⚠ CAUTION
INSTALLATION IN RESIDENTIAL GARAGES: The water heater must be located and/or protected so it is not subject to physical damage by a moving vehicle.

- The location selection must provide adequate clearances for servicing and proper operation of the water heater.

Optional Wall Mounting

⚠ WARNING
Wall construction at the point of the water heater installation must be capable of supporting at least 200 pounds.

As an example: if the water heater is to be installed on a wall of gypsum board (dry wall) or other material not capable of supporting the water heater filled with water, additional bracing will be necessary. Two possibilities are shown below.

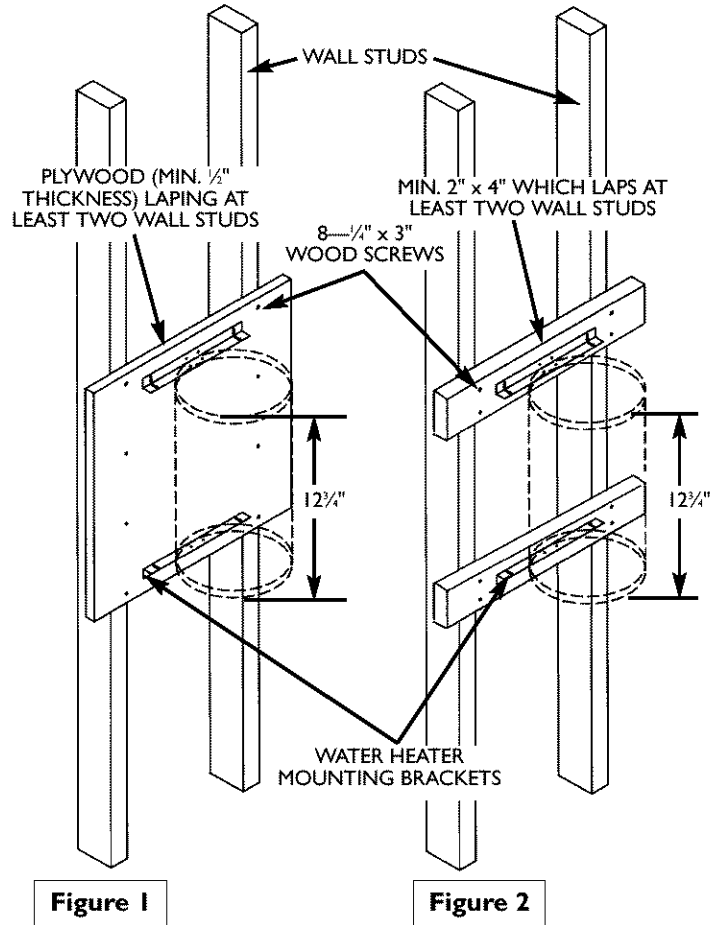

- Using two sheet metal screws supplied, secure the top mounting bracket to the top of the water heater.

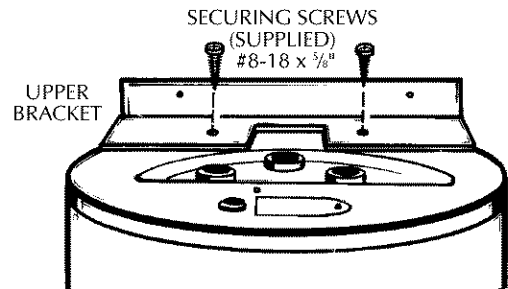

- Using the remaining two sheet metal screws provided, secure the bottom mounting bracket to the bottom of the water heater.

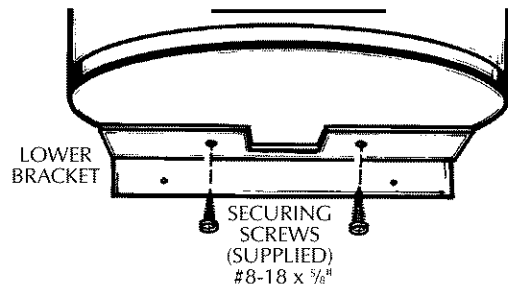

Installation Instructions (cont'd)

Optional Wall Mounting (cont'd)

- Determine the location on the wall, and then the height above the floor which the wall securing bracket will be placed. Using adequate screws, or nuts and bolts (not supplied), fasten the wall securing bracket to the wall.

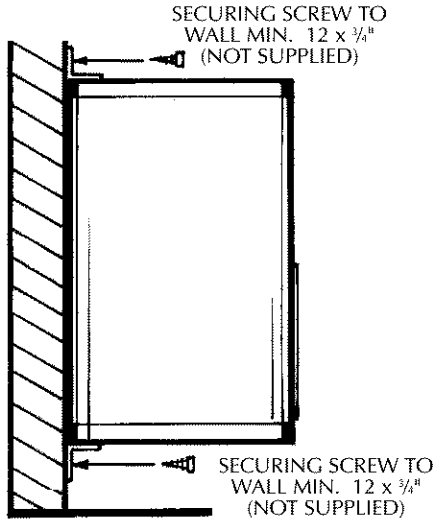

Water Piping

*⚠ WARNING

HOTTER WATER CAN SCALD: Water heaters are intended to produce hot water. Water heated to a temperature which will satisfy space heating, clothes washing, dish washing, and other sanitizing needs can scald and permanently injure you upon contact. Some people are more likely to be permanently injured by hot water than others. These include the elderly, children, the infirm, or physically/mentally handicapped. If anyone using hot water in your home fits into one of these groups or if there is a local code or state law requiring a certain temperature water at the hot water tap, then you must take special precautions. In addition to using the lowest possible temperature setting that satisfies your hot water needs, a means such as a mixing valve, shall be used at the hot water taps used by these people or at the water heater. Mixing valves are available at plumbing supply or hardware stores. Follow manufacturers instructions for installation of the valves. Before changing the factory setting on the thermostat, read the "Temperature Regulation" section in this manual.

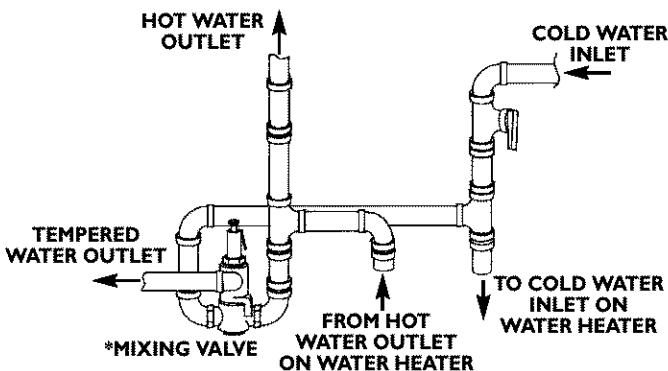

If a water heater is installed in a closed water supply system; such as one having a back-flow preventer, check valve, water meter with a check valve, etc... in the cold water supply; means must be provided to control thermal expansion. Contact the local utility or Sears Service Center on how to control this situation.

The illustration shows the attachment of the water piping to the water heater. The water heater is equipped with 1/2" water connections.

- Look at the top of the water heater. The hot water outlet is marked hot. Put two or three turns of teflon tape around the threaded end of the compression coupling and around the 3/4" threads of the 1/2" x 1/2" reducer bushing. Put two or three turns of teflon tape around both ends of a 1/2" threaded nipple (not supplied in the installation kit). Attach the 1/2" threaded nipple to the 3/4" x 1/2" reducer bushing and screw into the hot water outlet of the water heater. Using flexible connectors, connect the hot water pipe to the hot water outlet of the water heater.

NOTE: If using copper tubing, solder tubing to an adapter before attaching the adapter to the water connections. Do not solder the water supply lines directly to the connections of the water heater. It will harm the fittings on the water heater.

- Look at the top of the water heater. The cold water inlet is marked cold. Put two or three turns of teflon tape around the threaded end of the compression coupling and around the 3/4" threads of the 1/2" x 1/2" reducer bushing. Put two or three turns of teflon tape around both ends of a 1/2" threaded nipple (not supplied in the installation kit). Attach the 1/2" threaded nipple to the 3/4" x 1/2" reducer bushing and screw into the cold water inlet of the water heater. Using flexible connectors, connect the hot water pipe to the hot water outlet of the water heater.

NOTE: Your water heater is insulated to minimize heat loss from the tank. Further reduction in heat loss can be accomplished by insulating the hot water lines from the water heater.

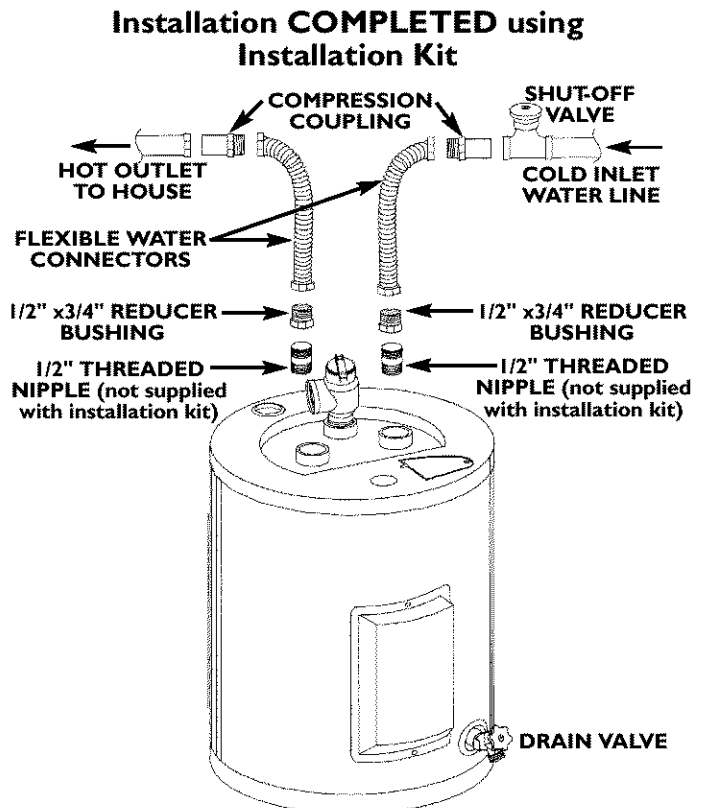

Installation Instructions (cont'd)

Temperature-Pressure Relief Valve

⚠ WARNING

At the time of manufacture this water heater was provided with a combination temperature-pressure relief valve certified by a nationally recognized testing laboratory that maintains periodic inspection of production of listed equipment or materials, as meeting the requirements for Relief Valves and Automatic Gas Shutoff Devices for Hot Water Supply Systems, and the current edition of ANSI Z21.22 • CSA 4.4 and the code requirements of ASME. If replaced, the valve must meet the requirements of local codes, but not less than a combination temperature and pressure relief valve certified as meeting the requirements for Relief Valves and Automatic Gas Shutoff Devices for Hot Water Supply Systems, ANSI Z21.22 • CSA 4.4 by a nationally recognized testing laboratory that maintains periodic inspection of production of listed equipment or materials.

The valve must be marked with a maximum set pressure not to exceed the marked hydrostatic working pressure of the water heater (150 lbs./sq. in.) and a discharge capacity not less than the water heater input rate as shown on the model rating plate. (Electric heaters - watts divided by 1000 x 3412 equal BTU/Hr. rate.)

Your local jurisdictional authority, while mandating the use of a temperature-pressure relief valve complying with ANSI Z21.22 • CSA 4.4 and ASME, may require a valve model different from the one furnished with the water heater.

Compliance with such local requirements must be satisfied by the installer or end user of the water heater with a locally prescribed temperature-pressure relief valve installed in the designated opening in the water heater in place of the factory furnished valve.

For safe operation of the water heater, the relief valve must not be removed from its designated opening or plugged.

The temperature-pressure relief valve must be installed directly into the fitting of the water heater designated for the relief valve. Position the valve downward and provide tubing so that any discharge will exit only within 6 inches above, or at any distance below the structural floor. Be certain that no contact is made with any live electrical part. The discharge opening must not be blocked or reduced in size under any circumstances. Excessive length, over 30 feet, or use of more than four elbows can cause restriction and reduce the discharge capacity of the valve.

No valve or other obstruction is to be placed between the relief valve and the tank. Do not connect tubing directly to discharge drain unless a 6" air gap is provided. To prevent bodily injury, hazard to life, or property damage, the relief valve must be allowed to discharge water in quantities should circumstances demand. If the discharge pipe is not connected to a drain or other suitable means, the water flow may cause property damage.

The Discharge Pipe:

- Must not be smaller in size than the outlet pipe size of the valve, or have any reducing couplings or other restriction.
- Must not be plugged or blocked.
- Must be of material listed for hot water distribution.
- Must be installed so as to allow complete drainage of both the temperature-pressure relief valve, and the discharge pipe.
- Must terminate at an adequate drain.
- Must not have any valve between the relief valve and tank.

⚠ WARNING

The temperature-pressure relief valve must be manually operated at least once a year. Caution should be taken to ensure that (1) no one is in front of or around the outlet of the temperature-pressure relief valve discharge line, and (2) the water manually discharged will not cause any bodily injury or property damage because the water may be extremely hot.

If after manually operating the valve, it fails to completely reset and continues to release water, immediately, close the cold water inlet to the water heater, follow the draining instructions, and replace the temperature-pressure relief valve with a new one.

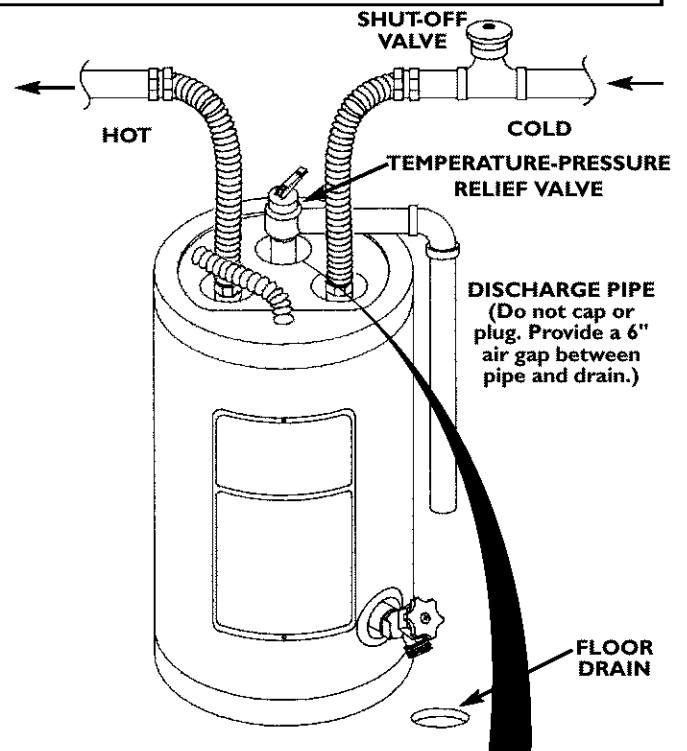

WARNING "RELIEF VALVE OPENING"

This water heater is provided with a combination Temperature-Pressure Relief Valve listed as complying with the standard for Relief Valves and Automatic Gas Shutoff Devices for Hot Water Supply Systems, ANSI Z21.22 and the code requirements of ASME.

Your local jurisdictional authority, while mandating the use of a Temperature-Pressure Relief Valve complying with ANSI Z21.22 and ASME, may require a valve model different from the one furnished with the water heater. Compliance with such local requirements must be satisfied by the installer or end user of the water heater with a locally prescribed Temperature-Pressure Relief Valve installed in the designated opening in the water heater.

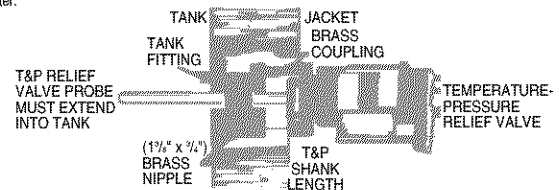

- If a short shank (less than 2") temperature-pressure relief valve is to be installed (as shown), a nipple and coupling must be used.
- If a long shank (2" or longer) is to be installed, do not use the nipple and coupling.

"Install Temperature-Pressure protective equipment required by local codes, but not less than a combination Temperature-Pressure Relief Valve certified as meeting the requirements for Relief Valves and Automatic Gas Shutoff Devices for Hot Water Supply Systems, ANSI Z21.22 by a nationally recognized testing laboratory that maintains periodic inspection of production of listed equipment or materials. The valve must be oriented, provided with tubing, or otherwise installed so that discharge can exit only within 6 inches above, or at any distance below the structural floor, and cannot contact any live electrical part."

For safe operation of the water heater, the Relief Valve must not be removed or plugged. See manual heading - "Temperature-Pressure Relief Valve" for installation and maintenance of Relief Valve, discharge pipe and other safety precautions.

Installation Instructions (cont'd)

Filling the Water Heater

To fill the water heater with water:

- Close the water heater drain valve by turning the handle to the right (clockwise). The drain valve is located on the lower front of the water heater.
- Open the cold water supply valve to the water heater.
NOTE: The cold water supply valve must be left open when the water heater is in use.
- To insure complete filling of the tank, allow air to exit by opening the nearest hot water faucet. Allow water to run until a constant flow is obtained. This will let air out of the water heater and the piping.

⚠ CAUTION

Never use this water heater unless it is completely full of water. To prevent damage to the tank and heating element, the tank must be filled with water. Water must flow from the hot water faucet before turning "ON" power.

- Check all new water piping for leaks. Repair as needed.

Optional Cord Set Wiring (120 Volt)

There may be a cord set supplied with the water heater at the time of manufacture. If not one can be ordered through the Parts Department, see "Repair Parts" section. Refer to figures on this page for wiring diagrams.

Wiring Diagrams

120 VOLT CORD SET

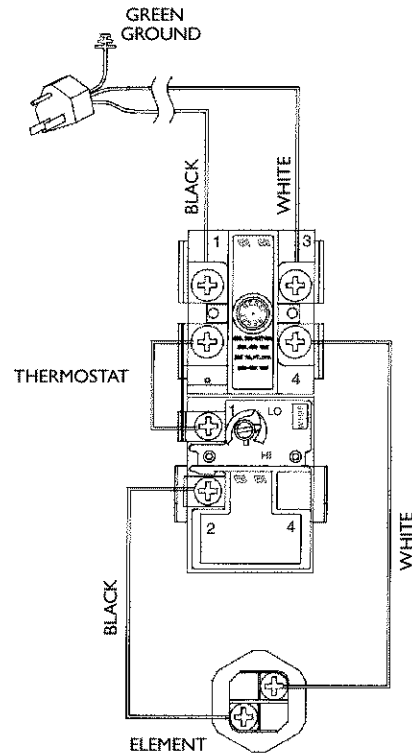

120 VOLT WIRING

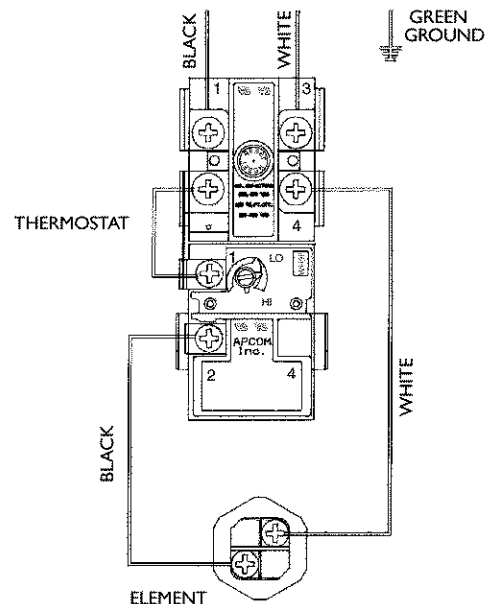

Installation Instructions (cont'd)

Wiring

⚠ CAUTION

Never use this water heater unless it is completely full of water. To prevent damage to the tank and heating element, the tank must be filled with water. Water must flow from the hot water faucet before turning "ON" power.

You must provide all wiring of the proper size outside of the water heater. You must obey local codes and electric company requirements when you install this wiring.

If you are not familiar with electric codes and practices, or if you have any doubt, even the slightest doubt, in your ability to connect the wiring to this water heater, obtain the service of a competent electrician. Contact your Sears salesperson to arrange for a professional electrician.

⚠ WARNING

WATER HEATERS EQUIPPED FOR ONE VOLTAGE ONLY: This water heater is equipped for one type voltage only. Check the rating plate near the bottom access panel for the correct voltage. DO NOT use this water heater with any voltage other than the one shown on the model rating plate. Failure to use the correct voltage can cause problems which can result in DEATH, SERIOUS BODILY INJURY, OR PROPERTY DAMAGE. If you have any questions or doubts consult your electric company.

⚠ CAUTION

If wiring from your fuse box or circuit breaker box was aluminum for your old water heater, replace it with copper wire. If you wish to reuse the existing aluminum wire, have the connection at the water heater made by a competent electrician. Contact your Sears salesperson to arrange for a professional electrician.

1. Provide a way to easily shut off the electric power when working on the water heater. This could be with a circuit breaker or fuse block in the entrance box or a separate disconnect switch.
2. Install and connect a circuit directly from the main fuse or circuit breaker box. This circuit must be the right size and have its own fuse or circuit breaker. Refer to the chart in the "Product Specifications" section for the correct size wire and fuse or circuit breaker.
3. If metal conduit is used for the grounding conductor:
 - A. The grounding electrode conductor shall be of copper, aluminum, or copperclad aluminum. The material shall be of one continuous length without a splice or joint.

- B. Rigid metal conduit, intermediate metal conduit, or electrical metallic tubing may be used for the grounding means if conduit or tubing is terminated in fittings approved for grounding.
- C. Flexible metal conduit or flexible metallic tubing shall be permitted for grounding if all the following conditions are met:
 1. The length in any ground return path does not exceed 6 feet.
 2. The circuit conductors contained therein are protected by overcurrent devices rated at 20 amperes or less.
 3. The conduit or tubing is terminated in fittings approved for grounding. For complete grounding details and all allowable exceptions, refer to the current edition of the National Electrical Code, NFPA 70.
 4. A standard 1/2" conduit opening has been made in the water heater junction box for the conduit connection.
 5. Use wire nuts and connect the power supply wiring to the wires inside the water heater's junction box.
 6. The water heater must be electrically "grounded" by the installer. A green ground screw has been provided on the water heater's junction box. Connect ground wire to this location.
 7. Replace the wiring junction cover using the screw provided.

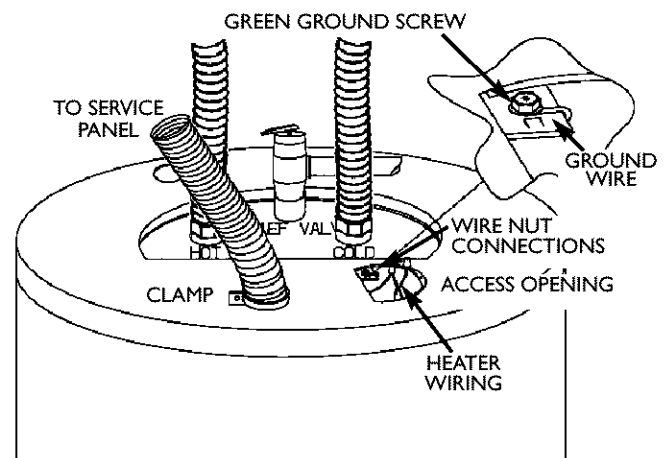

Installation Instructions (cont'd)

Installation Checklist

- Is the fuse or circuit breaker size correct as shown in the chart in the "Product Specifications" section?
- Are the wires from the circuit breaker or fuse service to the water heater's junction box on the correct wire size (gauge) as shown in the chart in the "Product Specifications" section?
- Is the new temperature-pressure relief valve properly installed, and piped to an adequate drain? See "Temperature-Pressure Relief Valve" section.
- Is the water heater completely filled with water? See "Filling the Water Heater" instructions in the "Installation Instructions" section.
- Will a water leak damage anything? See "Facts to Consider About the Location" section.
- Are the cold and hot water lines connected to the water heater correctly? See "Water Piping" instructions in the "Installation Instructions" section.
- Is there adequate clearance for maintenance around the water heater?
- Do you need to call your electric company to check your wiring?

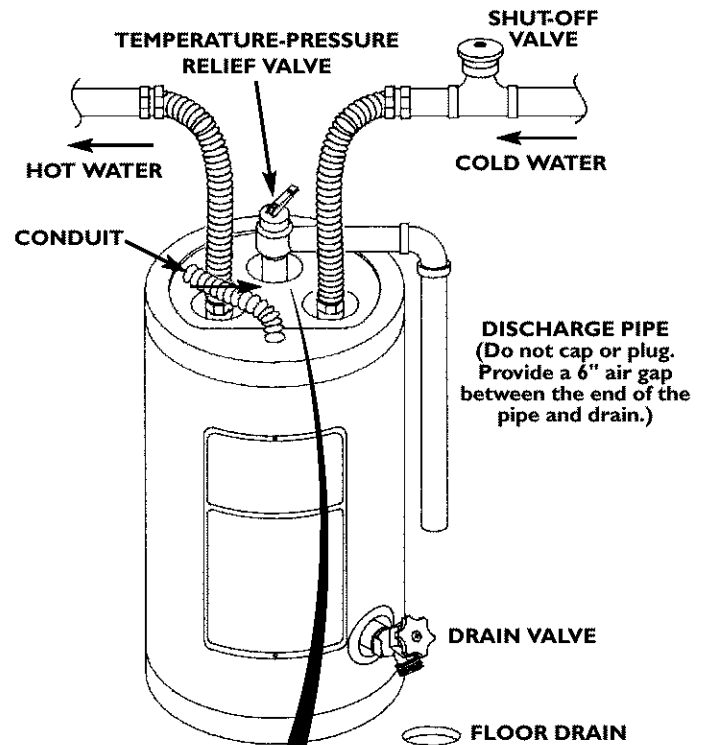

ELECTRIC WATER HEATER					ECO INSTALLED
IN CORRESPONDENCE RE- GARDING THIS HEATER ALL WAYS MENTION MODEL & SERIAL NO'S.			UL LIMITED 1949		
MODEL NUMBER		CAPACITY		SERIAL NUMBER	
FACTORY EQUIPPED WITH					U.S. GAL.
UPPER ELEMENT	LOWER ELEMENT	MAXIMUM	VOLTS	CHECK (✓) HERE	MAXIMUM HYDROSTATIC WORKING PRESSURE
					150
WATTS OPTIONAL WATTAGE UPPER ELEMENT	WATTS OPTIONAL WATTAGE LOWER ELEMENT	WATTS MAXIMUM	A.C. ONLY CHECK (✓) HERE	IF INSTALLED AS FACTORY EQUIPPED P.S.I.	
				WARNING SEE CONVERSION INSTRUCTION	
WATTS	WATTS	WATTS	IF CONVERTED		

MODEL RATING PLATE

Service and Adjustment

Temperature Regulation

⚠ WARNING

HOTTER WATER CAN SCALD: Water heaters are intended to produce hot water. Water heated to a temperature which will satisfy clothes washing, dish washing, and other sanitizing needs can scald and permanently injure you upon contact. Some people are more likely to be permanently injured by hot water than others. These include the elderly, children, the infirm, or physically/mentally handicapped. If anyone using hot water in your home fits into one of these groups or if there is a local code or state law requiring a certain temperature water at the hot water tap, then you must take special precautions. In addition to using the lowest possible temperature setting that satisfies your hot water needs, some type of tempering device, such as a mixing valve, should be used at the hot water taps used by these people or at the water heater. Mixing valves are available at plumbing supply or hardware stores. Follow manufacturers instructions for installation of the valves. Before changing the factory setting of the thermostat, read the "Temperature Regulation" section in this manual.

⚠ WARNING

Never allow small children to use a hot water tap, or to draw their own bath water. Never leave a child or handicapped person unattended in a bathtub or shower.

Thermostats

⚠ WARNING

This special thermostat with ECO (Part No. 9002394) can only be used with this water heater. Do not use any other thermostat with ECO.

The thermostat of this water heater has been factory set at the mid position which approximates 120°F (Hot) to reduce the risk of scald injury. The thermostat is adjustable if a different water temperature is desired. Read all warnings in this manual and on the water heater before proceeding.

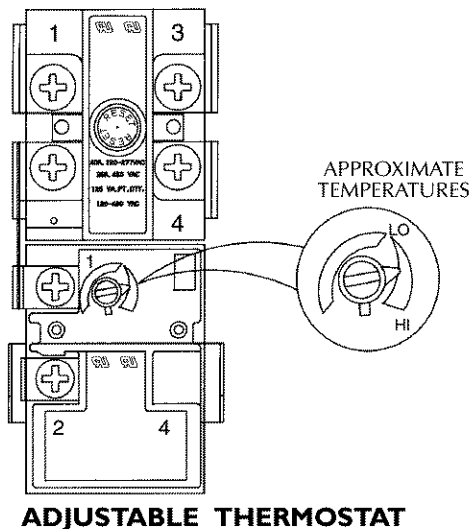

Temperature Settings

The thermostat is factory set at a position which approximates 120°F (Hot) and is adjustable if a different water temperature is desired. Read all warnings in this manual and on the water heater before proceeding.

LO— Setting, approximately 95°F, is recommended for vacations or extended periods of no hot water.

HI— Is a setting for the maximum hot water usage approximately 140°F, which can be supplied by the water heater. The temperature dial should be kept at a lower setting whenever possible.

NOTE: Water temperature range of 120°—140°F recommended by most dishwasher manufacturers.

Temperature Setting	Time to Produce 2nd & 3rd Degree Burns on Adult Skin
160°F	About 1/2 seconds
150°F	About 1-1/2 seconds
140°F	Less than 5 seconds
130°F	About 30 seconds
120°F	More than 5 minutes

Thermostat Adjustment

The thermostat is adjustable if a different water temperature is desired. Read all warnings in the "Temperature Regulation" section before proceeding.

To adjust the temperature setting:

1. Turn "OFF" the electrical power to the water heater at the junction box.

⚠ WARNING
HAZARD OF ELECTRICAL SHOCK! Before removing any access panels or servicing the water heater, make sure the electrical supply to the water heater is turned "OFF". Failure to do this could result in DEATH, SERIOUS BODILY INJURY, OR PROPERTY DAMAGE.

2. Take off the access panel and fold away the insulation.
3. Turn the water temperature dial clockwise (↻) to increase the temperature, or counter clockwise (↺) to decrease the temperature.
4. Fold the insulation back in place and replace the access panel.
5. Turn "ON" the power supply.

Service and Adjustment (cont'd)

Temperature-Pressure Relief Valve Operation

The temperature-pressure relief valve must be manually operated at least once a year.

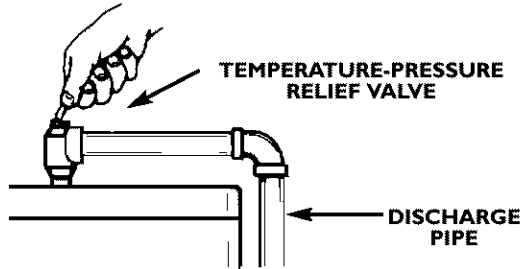

⚠ WARNING

The temperature-pressure relief valve must be manually operated at least once a year. Caution should be taken to ensure that (1) no one is in front of or around the outlet of the temperature-pressure relief valve discharge line, and (2) the water manually discharged will not cause any property damage or bodily injury. The water may be extremely hot.

If after manually operating the valve, it fails to completely reset and continues to release water, immediately close the cold water inlet to the water heater, follow the draining instructions, and replace the temperature-pressure relief valve with a new one.

Failure to install and maintain a new properly listed temperature-pressure relief valve will release the manufacturer from any claim which might result from excessive temperature or pressure.

⚠ WARNING

If the temperature-pressure relief valve on the appliance weeps or discharges periodically, this may be due to thermal expansion. Your water heater may have a check valve installed in the water line or a water meter with a check valve. Consult your local Sears Service Center for further information. Do not plug the temperature-pressure relief valve.

Draining

The water heater should be drained if being shut down during freezing temperatures. Also periodic draining and cleaning of sediment from the tank may be necessary.

- Before beginning turn "OFF" the electric power supply to the water heater.

⚠ WARNING

HAZARD OF ELECTRICAL SHOCK! Before removing any access panels or servicing the water heater, make sure the electrical supply to the water heater is turned "OFF". Failure to do this could result in **DEATH, SERIOUS BODILY INJURY, OR PROPERTY DAMAGE.**

- CLOSE the cold water inlet valve to the water heater.
- OPEN a nearby hot water faucet and leave open to allow for draining.
- Connect a hose to the drain valve and terminate to an adequate drain or outdoors.
- OPEN the water heater drain valve to allow for tank draining.

NOTE: If the water heater is going to be shut down and drained for an extended period, the drain valve should be left open with hose connected allowing water to terminate to an adequate drain.

- Close the drain valve.
- Follow "Filling the Water Heater" instructions in the "Installation Instructions" section.
- Turn "ON" power to the water heater.

⚠ CAUTION

Never use this water heater unless it is completely full of water. To prevent damage to the tank and heating element, the tank must be filled with water. Water must flow from the hot water faucet before turning "ON" power.

Service and Adjustment (cont'd)

Element Cleaning/ Replacement

To remove the element from your tank in order to clean or replace it:

1. Before beginning turn "OFF" the electric power supply to the water heater.

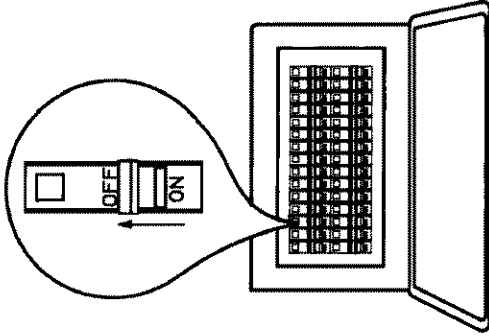

⚠ WARNING
HAZARD OF ELECTRICAL SHOCK! Before removing any access panels or servicing the water heater, make sure the electrical supply to the water heater is turned "OFF". Failure to do this could result in **DEATH, SERIOUS BODILY INJURY, OR PROPERTY DAMAGE.**

2. Turn off the water supply to the water heater at the water shutoff valve or water meter.



3. Attach a hose to the water heater drain valve and put the other end in a floor drain or outdoors. Open the water heater drain valve. Open a nearby hot water faucet which will relieve pressure in the water heater and speed draining.

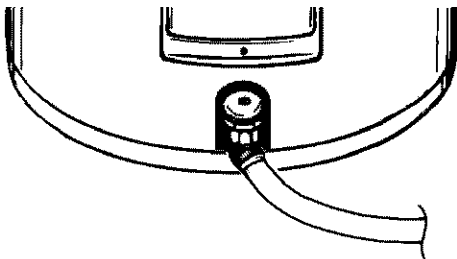

⚠ WARNING
The water passing out of the drain valve may be extremely hot. To avoid being scalded, make sure all connections are tight and that the water flow is directed away from any person.

4. Remove the two screws securing the access panel, and remove panel.

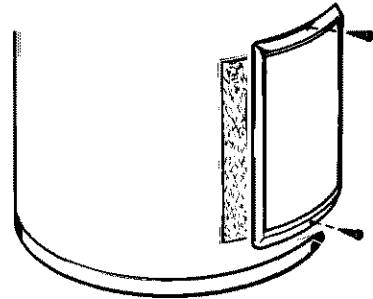

5. Open the flap of insulation to expose the opening.

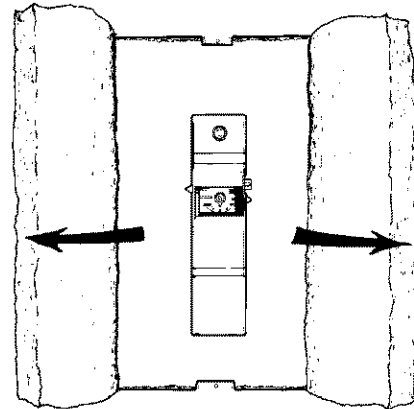

6. Lift out the tab as shown to unclip the terminal cover from the thermostat. The terminal cover can now be removed from the thermostat.

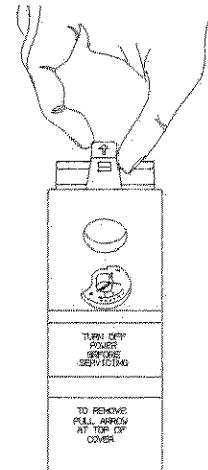

Service and Adjustment (cont'd)

Element Cleaning/ Replacement (cont'd)

7. Disconnect the two wires on the element and unscrew the old element from the tank.

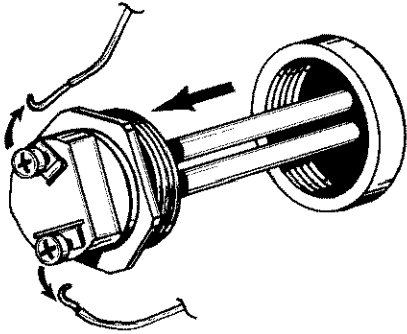

8. Clean the area around the element opening. Remove any sediment from or around the element opening, inside the tank.
9. If you are cleaning the element you have removed, do so by scraping or soaking in vinegar or a de-liming solution.

⚠ WARNING

Replacement elements must (1) be the same voltage and (2) no greater wattage than listed on the model rating plate affixed to the water heater.

10. A new gasket should be used in all cases to prevent a possible water leak. (See Element Gasket in the "Parts Order List" Chart). Place the new element gasket on the thread side of the cleaned or new element and screw into tank, securing tightly using an element wrench.

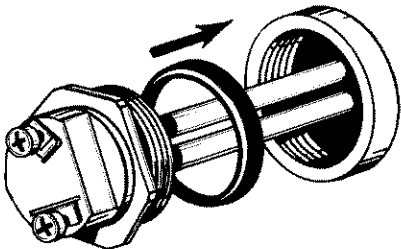

11. Close the water heater drain valve by turning the handle to the right (clockwise). The drain valve is on the lower front of the water heater.

12. Open the cold water supply valve to the water heater.
NOTE: The cold water supply valve must be left open when the water heater is in use.
13. To insure complete filling of the tank, allow air to exit by opening the nearest hot water faucet. Allow water to run until a constant flow is obtained. This will let air out of the water heater and the piping.

⚠ CAUTION

Never use this water heater unless it is completely full of water. To prevent damage to the tank and heating element, the tank must be filled with water. Water must flow from the hot water faucet before turning "ON" power.

14. Check element for water leaks. If leakage occurs, tighten element or repeat steps 2 and 3, remove element and reposition gasket. Then repeat steps 10 through 14.
15. Reconnect the two wires to the element and then check to make sure the thermostat remains firmly against the surface of the tank.

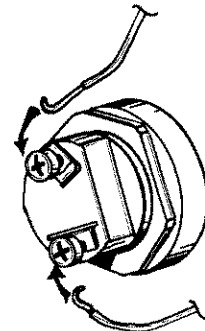

16. Replace terminal cover on thermostat and fold insulation back over the element.

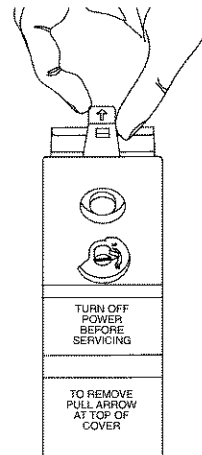

Service and Adjustment (cont'd)

17. Fold the insulation back in place so that it completely covers the thermostat and element.

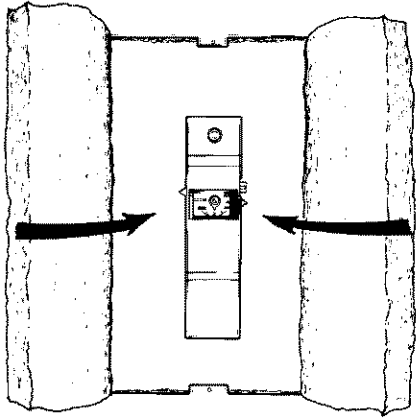

18. Replace access panel.
19. Turn "ON" electric power to water heater.

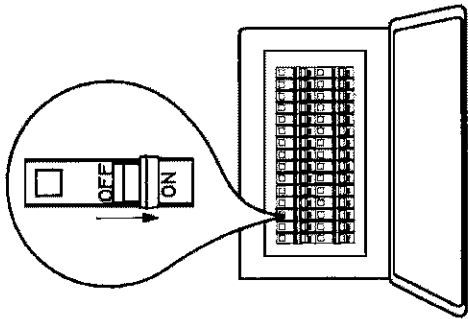

Drain Valve Washer Replacement

NOTE: For replacement, use a $\frac{1}{32}$ " x $\frac{3}{4}$ " x $\frac{1}{8}$ " thick washer available at your nearest hardware store. For ordering a replacement washer, refer to the "Parts Order List" section.

- Before beginning turn "OFF" the electrical power supply to the water heater.

⚠ WARNING

HAZARD OF ELECTRICAL SHOCK! Before removing any access panels or servicing the water heater, make sure the electrical supply to the water heater is turned "OFF". Failure to do this could result in **DEATH, SERIOUS BODILY INJURY, OR PROPERTY DAMAGE.**

- Follow "Draining" instructions in the "Service and Adjustment" section.
- Turning counter clockwise, remove the hex cap below the screw handle.
- Remove the washer and put the new one in place.
- Screw the handle and cap assembly back into the drain valve and retighten using a wrench. **DO NOT OVER TIGHTEN.**
- Follow "Filling the Water Heater" instructions in the "Installation Instructions" section.
- Check for leaks.
- Turn "ON" electric power to the water heater.



⚠ CAUTION

Never use this water heater unless it is completely full of water. To prevent damage to the tank and heating element, the tank must be filled with water. Water must flow from the hot water faucet before turning "ON" power.

Service

Before calling for repair service, read the "Start Up Conditions" and "Operational Conditions" found in the Troubleshooting Guide of this manual.

If a condition persists or you are uncertain about the operation of the water heater, let a qualified person check it out.

Contact SEARS Repair Services at 1-800-4-MY-HOME (1-800-469-4663)

Troubleshooting Guide

Start Up Conditions

THERMAL EXPANSION

Water supply systems may, because of such events as high line pressure, frequent cut-offs, the effects of water hammer among others, have installed devices such as pressure reducing valves, check valves, back flow preventers, etc...to control these types of problems. When these devices are not equipped with an internal by-pass, and no other measures are taken, the devices cause the water system to be closed. As water is heated, it expands (thermal expansion) and closed systems do not allow for the expansion of heated water.

The water within the water heater tank expands as it is heated and increases the pressure of the water system. If the relieving point of the water heater's temperature-pressure relief valve is reached, the valve will relieve the excess pressure. **The temperature-pressure relief valve is not intended for the constant relief of thermal expansion.** This is an unacceptable condition and must be corrected.

It is recommended that any devices installed which could create a closed system have a by-pass and/or the system have an expansion tank to relieve the pressure built by thermal expansion. Thermal expansion tanks are available from Sears stores and through the Sears Service Centers. Contact the local plumbing inspector, water supplier and/or the Sears Service Center for assistance in controlling these situations.

Thermal Expansion Tank Specifications

Model Number	Tank Capacity In Gallons	Dimensions in Inches		Pipe Fitting On Tank
		Diameter	Length	
153.331020	2	8 inches	12¾ inches	¾" Male

Expansion Tank Sizing Chart

Expansion Tank Capacity Needed	Inlet* Water Pressure 40-80psi	Water Heater Capacity (Gallons)				
		2	4	6	10	19.9
		2	2	2	2	2

*Highest recorded inlet water pressure in a 24 hour period or regulated water pressure.

NOTE: Expansion tanks are pre-charged with a 40 psi air charge. If the inlet water pressure is higher than 40 psi, the expansion tank's air pressure must be adjusted to match that pressure, but must not be higher than 80 psi.

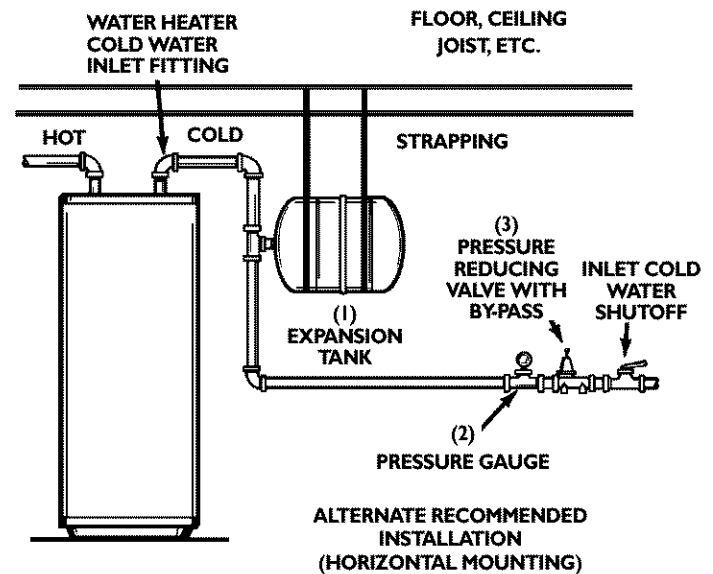
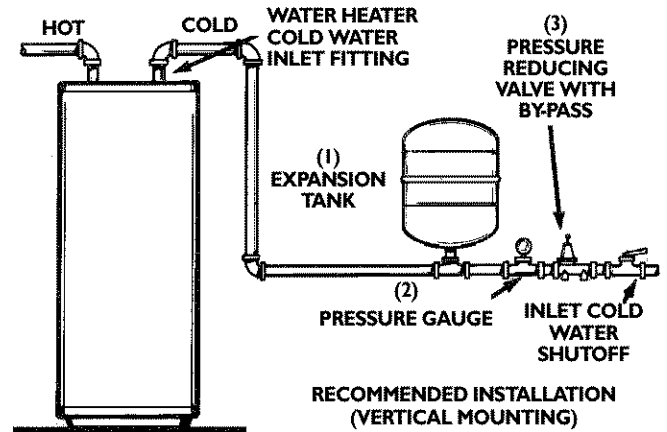

STRANGE SOUNDS

Possible noises due to expansion and contraction of some metal parts during periods of heat-up and cool-down do not represent harmful or dangerous conditions.

Troubleshooting Guide

Operational Conditions

SMELLY WATER

In each water heater there is installed an anode rod for corrosion protection of the tank. Certain water conditions will cause a reaction between this rod and the water. The most common complaint associated with the anode rod is one of a “rotten egg smell”. This odor is derived from hydrogen sulfide gas dissolved in the water. The smell is the result of four factors which must all be present for the odor to develop:

- a concentration of sulfate in the supply water.
- little or no dissolved oxygen in the water.
- a sulfate reducing bacteria within the water heater. (This harmless bacteria is non-toxic to humans.)
- an excess of active hydrogen in the tank. This is caused by the corrosion protective action of the anode.

The anode rod in a new glasslined water heater works rapidly to protect the tank. After a period of time the anode action slows and the odor may dissipate.

A smelly water condition (Rotten Egg Odor) in your Point of Use water heater can, in most cases, be resolved or reduced with the addition of sufficient amounts of chlorine to eliminate the bacterial growth inside the tank. This can be accomplished through the installation of a chlorine feeder to the system or the periodic flushing of the water heater with “Chlorox” as needed. On systems where the odor is mild and does not occur too rapidly, a monthly flushing may be sufficient. In more severe cases, a system feeder would be more appropriate.

“AIR” IN HOT WATER FAUCETS

⚠ WARNING

HYDROGEN GAS: Hydrogen gas can be produced in a hot water system that has not been used for a long period of time (generally two weeks or more). Hydrogen gas is extremely flammable and explosive. To prevent the possibility of injury under these conditions, we recommend the hot water faucet be opened for several minutes at the kitchen sink before any electrical appliances which are connected to the hot water system are used (such as a dishwasher or washing machine). If hydrogen gas is present, there will probably be an unusual sound similar to air escaping through the pipe as the hot water faucet is opened. There must be no smoking or open flame near the faucet at the time it is open.

RUMBLING NOISE

In some water areas, scale or mineral deposits will build up on your heating elements. This buildup will cause a rumbling noise. Follow “Element Cleaning/Replacement” instructions to clean and replace the elements.

HIGH TEMPERATURE SHUT OFF SYSTEM

The water heater has a high limit shut off system with a reset button located on the thermostat.

Follow the resetting instructions which refer to the high limit behind the access panel.

- Before beginning, turn “OFF” electrical power supply to the water heater.

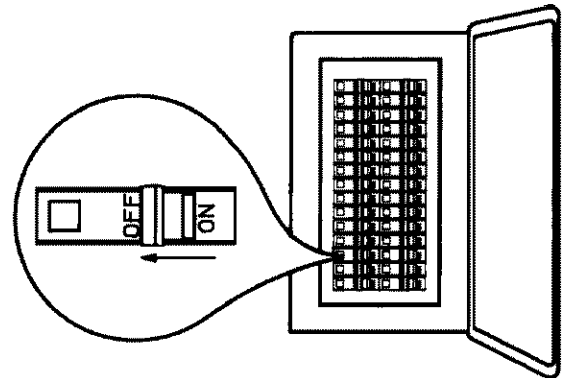

⚠ WARNING

HAZARD OF ELECTRICAL SHOCK! Before removing any access panels or servicing the water heater, make sure the electrical supply to the water heater is turned “OFF”. Failure to do this could result in DEATH, SERIOUS BODILY INJURY, OR PROPERTY DAMAGE.

Troubleshooting Guide (cont'd)

HIGH TEMPERATURE SHUT OFF SYSTEM (cont'd)

- Remove the two screws securing the access panel and remove panel.
- Open the flap of insulation to expose the opening.
- Reset the high limit by pushing in the red button marked "RESET".

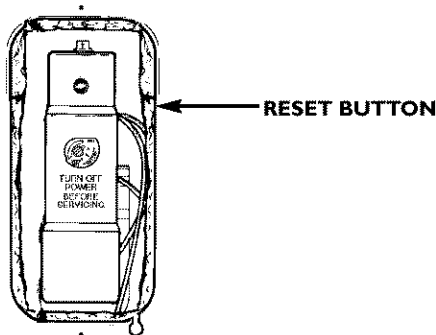

- Fold the insulation back in place so that it completely covers the thermostat and element.
- Replace the access panel.
- Turn "ON" electric power to the water heater.

⚠ CAUTION

If the high limit must be reset again, call Sears Service Department to find out why the high limit turned "OFF" the electric power.

NOT ENOUGH OR NO HOT WATER

- In a new installation, the water heater may not be properly connected. Make sure the cold water supply valve is open. Review and check piping installation. Make sure that the cold water line is connected to the cold water inlet to the water heater and the hot water line to the hot water outlet on the water heater.
- Make sure the electrical supply to your water heater is "ON".
- Check for loose or blown fuses in your water heater circuit. Circuit breakers weaken with age and may not handle their rated load and should be replaced.
- Make certain the disconnect switch, if used, is in the "ON" position.
- Check to see the electric service to your house has not been interrupted. If this is the case, contact the electric company.
- Is the thermostat set to the desired temperature? See "Temperature Regulation" section.
- If you had experienced very hot water and now no hot water, the problem may be due to the high temperature shut off system. See "High Temperature Shut Off System" in the "Troubleshooting" section.
- During very cold weather, the incoming water will also be colder and it will require a longer time to become heated.
- The hot water usage may exceed the capacity of the water heater. If so, wait for water heater to recover after abnormal demand. Also examine pipes and faucets for possible water leaks.
- If you can not determine the problem, then call the Sears Service Department.

WATER IS TOO HOT

Adjust the thermostat to a lower setting. See the "Temperature Regulation" section.

Troubleshooting guide (cont'd)

Leakage Checkpoints

Use this guide to check a "Leaking" water heater. Many suspected "Leakers" are not leaking tanks. Often the source of the water can be found and corrected.

If you are not thoroughly familiar with electric codes, the water heater, and safety practices, contact a Sears Service Center to check the water heater.

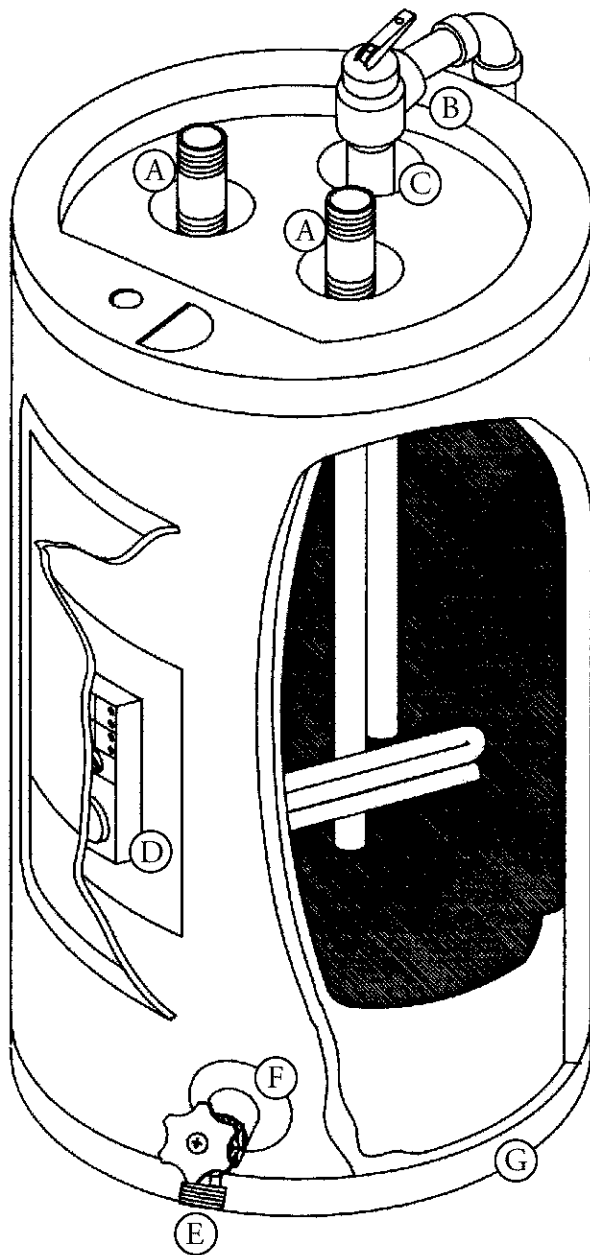

⚠ CAUTION

Read this manual first. Then before checking the water heater make sure the electric supply has been turned "OFF", and never turn the electric supply "ON" before the tank is completely full of water.

- (A) *Condensation may be seen on pipes in humid weather or pipe connections may be leaking.
- (B) Small amounts of water from the temperature-pressure relief valve may be due to thermal expansion or high water pressure in your area.
- (C) *The temperature-pressure relief valve may be leaking at the tank fitting.
- (D) The element may be leaking at the tank fitting.

⚠ WARNING

HAZARD OF ELECTRICAL SHOCK! Before removing any access panels or servicing the water heater, make sure the electrical supply to the water heater is turned "OFF". Failure to do this could result in DEATH, SERIOUS BODILY INJURY, OR PROPERTY DAMAGE.

Turn electrical power "OFF", remove access panel and fold back insulation. If leaking around element, follow proper draining instructions and remove element. Reposition or replace gasket on element. Place element into opening and tighten securely. Then follow "Filling the Water Heater" instructions in the "Installation Instructions" section.

- (E) Water from drain valve may be due to the valve being opened slightly.
- (F) *The drain valve may be leaking at the tank fitting.
- (G) *Water in the water heater bottom or on the floor may be from condensation, loose connections or the temperature-pressure relief valve. **DO NOT** replace the water heater until a full inspection of all possible water sources is made and necessary corrective steps taken.

Leakage from other appliances, water lines, or ground seepage should also be checked.

NOTE: To check where threaded portion enters tank, insert cotton swab between jacket opening and fitting. If cotton is wet, follow "Draining" instructions in the "Service and Adjustment" section and then remove fitting. Put pipe dope or teflon tape on the threads and replace. Then follow "Filling the Water Heater" instructions in the "Installation Instructions" section.

Parts Order List

KENMORE POINT OF USE ELECTRIC WATER HEATER
MODEL NUMBER:

153.317020 2 Gal.

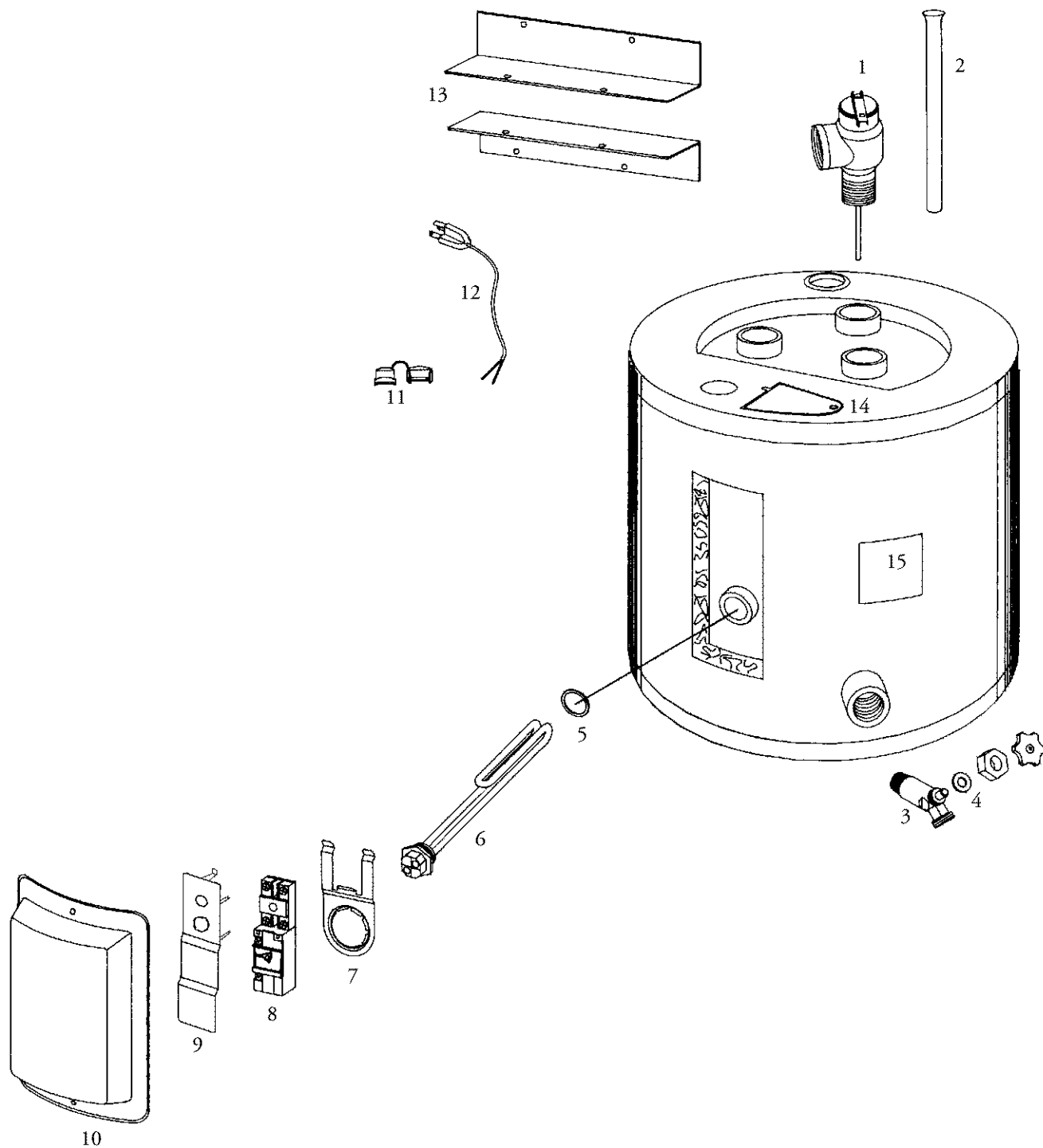

Parts Order List (cont'd)

KENMORE POINT OF USE ELECTRIC WATER HEATER
MODEL NUMBER:

153.317020 2 Gal.

KEY NO.	PART DESCRIPTION	MODEL NUMBERS
		153.317020
		PART NUMBERS
1.	Temperature-Pressure Relief Valve	9000071
2.	Dip Tube & Gasket	9002396
3.	Drain Valve	9002402
4.	Drain Valve Washer ($\frac{1}{32}$ " x $\frac{1}{64}$ " x $\frac{1}{8}$ " thick)*	9001584
5.	Element Gasket	9000308
6.	Element	9001511
7.	Thermostat Bracket	9000309
8.	Thermostat w/Hi Limit	9002394
9.	Terminal Cover	9002438
10.	Access Panel	9001472
11.	Wiring Bushing	9001514
12.	Cord Set – 120 Volt	9001513
13.	Mounting Brackets	9001512
14.	Junction Box Cover	9001474
15.	Model Rating Plate†	0270182
#	Manual	184734-000

*Also available at most hardware stores.

†Replaced only on return of damaged plate.

#Not Illustrated

Now that you have purchased your Water Heater, should a need ever exist for repair parts or service, simply contact any SEARS Service Center or call 1-800-4-MY-HOME (1-800-469-4663). Be sure to provide all pertinent facts when you call or visit.

All parts listed may be ordered from any SEARS Service Center, most SEARS stores, and by calling 1-800-366-PART (1-800-366-7278).

If the parts you need are not stocked locally, your order will be electronically transmitted to a SEARS Repair Parts Distribution Center for handling

The model number of the water heater will be found on the model rating plate located beside the access panel.

WHEN ORDERING REPAIR PARTS, ALWAYS GIVE THE FOLLOWING INFORMATION:

MODEL NUMBER NAME OF ITEM
PART NUMBER PART DESCRIPTION

THIS IS A REPAIR PARTS LIST, NOT A PACKING LIST.

FULL 90 DAY WARRANTY ON WATER HEATER

For 90 days from the date of purchase, when your Sears Kenmore water heater is installed and operated in a single-family residence in accordance with the instructions in this manual, Sears will:

1. Repair defects in material or workmanship in this water heater, free of charge.
2. Furnish and install a new current model water heater of equal capacity and quality, free of charge, if a leak occurs in the tank.

LIMITED WARRANTY ON TANKS THAT LEAK

After 90 days and through 1 year from the date of purchase for a water heater used in a single-family residence, if a leak occurs in the tank, Sears will furnish a new current model water heater of equal capacity and quality. You will be charged for any installation.

To obtain warranty service, SIMPLY CALL 1-800-4-MY-HOME® (1-800-469-4663). This warranty applies only while this product is in use in the United States.

This warranty gives you specific legal rights and you may also have other rights which vary from state to state.

SEARS, ROEBUCK AND CO., Dept. 817 WA, HOFFMAN ESTATES, IL 60179

The price of your water heater does not include a free checkup service call. On water heater installations arranged by Sears, Sears warrants the installation. A charge will be made on service calls due to poor or incomplete installation. These include:

- a. Adjusting thermostat
- b. Leaks in pipes or fittings
- c. Condensation

MASTER PROTECTION AGREEMENTS

Congratulations on making a smart purchase. Your new Kenmore® product is designed and manufactured for years of dependable operation. But like all products, it may require preventive maintenance or repair from time to time. That's when having a Master Protection Agreement can save you money and aggravation.

Purchase a Master Protection Agreement now and protect yourself from unexpected hassle and expense.

The Master Protection Agreement also helps extend the life of your new product. Here's what's included in the Agreement:

- **Expert Service** by our 12,000 professional repair specialists.
- **Unlimited service and no charge** for parts and labor on all covered repairs.
- **"No-lemon" guarantee** - replacement of your covered product if four or more product failures occur within twelve months.
- **Product replacement** if your covered product can't be fixed.
- **Annual Preventive Maintenance Check** at your request - no extra charge.

- **Fast help by phone** - phone support from a Sears technician on products requiring in-home repair, plus convenient repair scheduling.
- **Power surge protection** against electrical damage due to power fluctuations.
- **Rental reimbursement** if repair of your covered product takes longer than promised.

Once you purchase the Agreement, a simple phone call is all that it takes for you to schedule service. You can call anytime day or night, or schedule a service appointment on-line.

Sears has over 12,000 professional repair specialists, who have access to over 4.5 million quality parts and accessories. That's the kind of professionalism you can count on to help prolong the life of your new purchase for years to come. Purchase your Master Protection Agreement today!

Some limitations and exclusions apply. For prices and additional information call 1-800-827-6655

SEARS INSTALLATION SERVICE

For Sears professional installation of home appliances, garage door openers, water heaters and other major home items, in the U.S.A., call 1-800-4-MY-HOME®.

For in-home major brand repair service
Call 24 hours a day, 7 days a week (U.S.A. and Canada)

1-800-4-MY-HOME®

(1-800-469-4663)

www.sears.com

The model number of your water heater is found on the model rating plate on the front of the water heater.

Sears, Roebuck and Co., Hoffman Estates, IL 60179 U.S.A.

Free Manuals Download Website

<http://myh66.com>

<http://usermanuals.us>

<http://www.somanuals.com>

<http://www.4manuals.cc>

<http://www.manual-lib.com>

<http://www.404manual.com>

<http://www.luxmanual.com>

<http://aubethermostatmanual.com>

Golf course search by state

<http://golfingnear.com>

Email search by domain

<http://emailbydomain.com>

Auto manuals search

<http://auto.somanuals.com>

TV manuals search

<http://tv.somanuals.com>