



Owners Manual

FOR POTABLE WATER
HEATING ONLY
NOT SUITABLE FOR
SPACE HEATING

Model No.

153.327164	30 Gal. Short
153.327264	40 Gal. Short
153.327363	30 Gal.
153.327364	30 Gal.
153.327463	40 Gal.
153.327464	40 Gal.
153.327563	50 Gal.
153.327564	50 Gal.
153.327663	66 Gal.
153.327664	66 Gal.
153.327863	82 Gal.
153.327864	82 Gal.

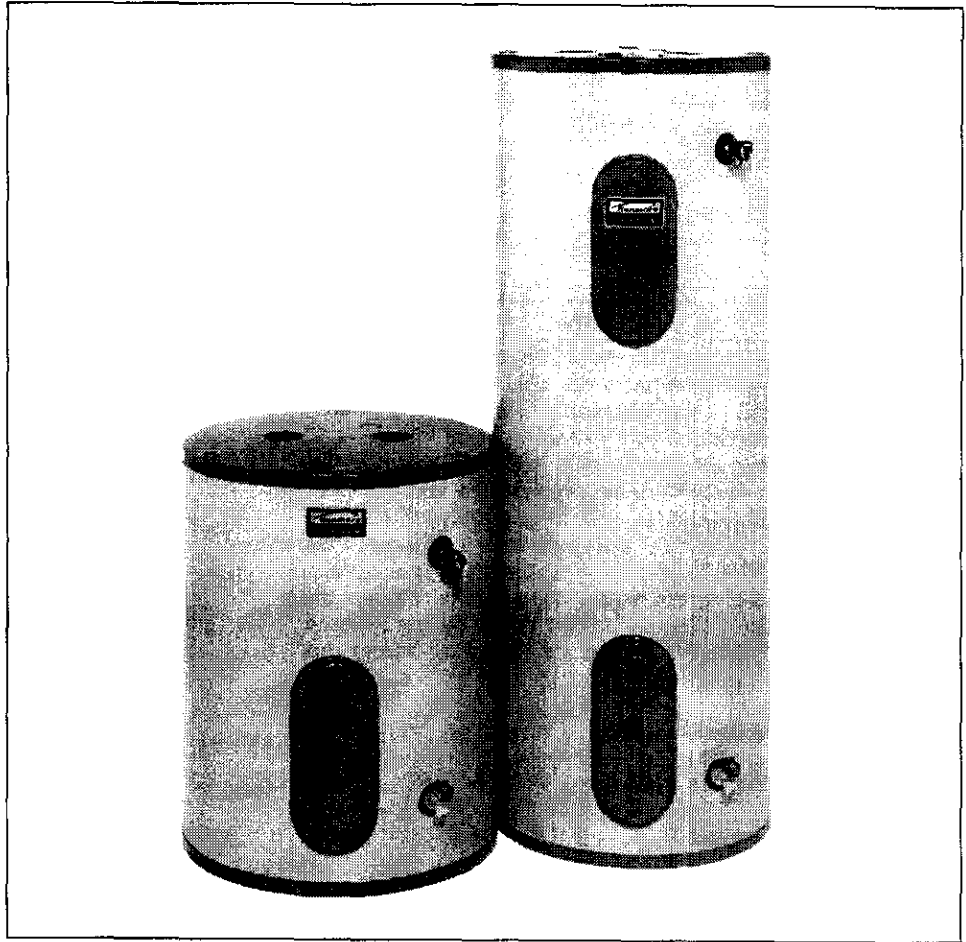

POWER MISER™ 9+ ELECTRIC WATER HEATER

- Safety Instructions
- Installation
- Operation
- Care and Maintenance
- Troubleshooting
- Parts List

Caution:
Read and Follow
All Safety Rules and
Operating Instructions
Before First Use of
This Product.



GAMA certification applies to all residential electric water heaters with capacities of 20 to 120 Gallons. Input rating of 12 Kw or less at a voltage no greater than 250 V.

Save this Manual for Future Reference.

⚠ WARNING

READ THE GENERAL SAFETY SECTION BEGINNING ON INSIDE COVER AND THEN THIS ENTIRE MANUAL BEFORE INSTALLING OR OPERATING THIS WATER HEATER.

Sears, Roebuck and Co., Hoffman Estates, IL 60179 U.S.A.

Safety Precautions

▲ WARNING

Improper installation, adjustment, alteration, service or maintenance can cause **DEATH, SERIOUS BODILY INJURY, OR PROPERTY DAMAGE**. Refer to this manual for assistance or consult your local Sears Service Center for further information.

▲ WARNING

At the time of manufacture this water heater was provided with a combination temperature-pressure relief valve certified by a nationally recognized testing laboratory that maintains periodic inspection of production of listed equipment or materials, as meeting the requirements for Relief Valves and Automatic Gas Shutoff Devices for Hot Water Supply Systems, and the latest edition of ANSI Z21.22 and the code requirements of ASME. If replaced, the valve must meet the requirements of local codes, but not less than a combination temperature and pressure relief valve certified as meeting the requirements for Relief Valves and Automatic Gas Shutoff Devices for Hot Water Supply Systems, ANSI Z21.22 by a nationally recognized testing laboratory that maintains periodic inspection of production of listed equipment or materials.

The valve must be marked with a maximum set pressure not to exceed the marked hydrostatic working pressure of the water heater (150 lbs./sq. in.) and a discharge capacity not less than the water heater input rate as shown on the model rating plate. (Electric heaters - watts divided by 1000 x 3415 equal BTU/Hr. rate.)

Your local jurisdictional authority, while mandating the use of a temperature-pressure relief valve complying with ANSI Z21.22 and ASME, may require a valve model different from the one furnished with the water heater.

Compliance with such local requirements must be satisfied by the installer or end user of the water heater with a locally prescribed temperature-pressure relief valve installed in the designated opening in the water heater in place of the factory furnished valve.

For safe operation of the water heater, the relief valve must not be removed from its designated opening or plugged.

The temperature-pressure relief valve must be installed directly into the fitting of the water heater designated for the relief valve. Position the valve downward and provide tubing so that any discharge will exit only within 6 inches above, or at any distance below the structural floor. Be certain that no contact is made with any live electrical part. The discharge opening must not be blocked or reduced in size under any circumstances. Excessive length, over 30 feet, or use of more than four elbows can cause restriction and reduce the discharge capacity of the valve.

No valve or other obstruction is to be placed between the relief valve and the tank. Do not connect tubing directly to discharge drain unless a 6" air gap is provided. To prevent bodily injury, hazard to life, or property damage, the relief valve must be allowed to discharge water in quantities should circumstances demand. If the discharge pipe is not connected to a drain or other suitable means, the water flow may cause property damage.

The Discharge Pipe:

- Must not be smaller in size than the outlet pipe size of the valve, or have any reducing couplings or other restrictions
- Must not be plugged or blocked.
- Must be of material listed for hot water distribution.
- Must be installed so as to allow complete drainage of both the temperature-pressure relief valve, and the discharge pipe.
- Must terminate at an adequate drain.
- Must not have any valve between the relief valve and tank.

▲ WARNING

HAZARD OF ELECTRICAL SHOCK! Before removing any access panels or servicing the water heater, make sure the electrical supply to the water heater is turned "OFF". Failure to do this could result in **DEATH, SERIOUS BODILY INJURY, OR PROPERTY DAMAGE**.

▲ WARNING

HOTTER WATER CAN SCALD: Water heaters are intended to produce hot water. Water heated to a temperature which will satisfy space heating, clothes washing, dish washing, and other sanitizing needs can scald and permanently injure you upon contact. Some people are more likely to be permanently injured by hot water than others. These include the elderly, children, the infirm, or physically/mentally handicapped. If anyone using hot water in your home fits into one of these groups or if there is a local code or state law requiring a certain temperature water at the hot water tap, then you must take special precautions. In addition to using the lowest possible temperature setting that satisfies your hot water needs, a means such as a mixing valve, shall be used at the hot water taps used by these people or at the water heater. Mixing valves are available at plumbing supply or hardware stores. Follow manufacturers instructions for installation of the valves. Before changing the factory setting on the thermostat, read the "Temperature Regulation" section in this manual.

▲ WARNING

WATER HEATERS EQUIPPED FOR ONE VOLTAGE ONLY: This water heater is equipped for one type voltage only. Check the rating plate near the bottom access panel for the correct voltage. **DO NOT** use this water heater with any voltage other than the one shown on the model rating plate. Failure to use the correct voltage can cause problems which can result in **DEATH, SERIOUS BODILY INJURY, OR PROPERTY DAMAGE**. If you have any questions or doubts consult your electric company.

▲ WARNING

INSULATING JACKETS: When installing an external water heater installation jacket on an electric water heater:

- DO NOT** cover the temperature-pressure relief valve.
- DO NOT** put insulation over the access covers or any access areas.
- DO NOT** cover or remove operating instructions, and safety related warning labels and materials affixed to the water heater.

▲ WARNING

Do not use this appliance if any part of it has been under water. An electrical short or malfunction could occur. The water heater should be replaced.

▲ CAUTION

WATER HEATERS EVENTUALLY LEAK: Installation of the water heater must be accomplished in such a manner that if the tank or any connections should leak, the flow of water will not cause damage to the structure. When such locations cannot be avoided, a suitable drain pan should be installed under the water heater. Drain pans are available at your local Sears Store. Such a drain pan must be piped to an adequate drain. Under no circumstances is the manufacturer or Sears to be held liable for any water damage in connection with this water heater.

Table of Contents

Safety Precautions.....	2
Table of Contents.....	3
Introduction.....	4
Product Specifications.....	4
Preparing for the New Installation.....	4
Materials and Basic Tools Needed.....	5
Materials Needed.....	5
Basic Tools.....	5
Installation Instructions.....	6-15
Removing the Old Water Heater.....	6
Facts to Consider About the Location.....	7
Facts to Consider About the Convertible Element.....	7
Water Piping.....	8
Temperature-Pressure Relief Valve.....	9
Filling the Water Heater.....	10
Converting the Lower Element.....	10-12
Wiring Diagrams.....	13
Wiring.....	14
Installation Checklist.....	15
Service and Adjustment.....	16-20
Temperature Regulation.....	16
Thermostats.....	16
Thermostat Settings.....	16
Upper Thermostat Adjustment.....	16
Lower Thermostat Adjustment.....	17
Temperature-Pressure Relief Valve Operation.....	17
Draining.....	17
Element Cleaning and Replacement.....	18-20
Drain Valve Washer Replacement.....	20
Service.....	20
Troubleshooting Guide.....	21-24
Start Up Conditions.....	21
Thermal Expansion.....	21
Strange Sounds.....	21
Operational Conditions.....	22
Rumbling Noise.....	22
High Temperature Shut Off System.....	22
Not Enough or No Hot Water.....	22
Water is Too Hot.....	22
Leakage Checkpoints.....	23
Parts Order List.....	24-27
Warranty.....	28

Introduction

Thank You for purchasing a Sears water heater. Properly installed and maintained, it should give you years of trouble free service. If you should decide that you want the new water heater professionally installed, contact the local Sears Service Center or any Sears store. They will arrange for prompt, quality installation by Sears authorized contractors.

Abbreviations Found In This Instruction Manual
 U.L.-Underwriters Laboratories, 333 Pfingsten Rd., Northbrook, IL 60062
 National Electrical Code-This publication is available from your local government or public library or electric company or by writing to U.L. above.
 A.N.S.I.-American National Standards Institute

Product Specifications

MODEL NUMBER	TANK CAPACITY IN GALLONS	DIMENSIONS IN INCHES		RECOVERY RATE GALS. PER HOUR @90°F. RISE	ELEMENT WATTAGE AT 240 VOLTS		MINIMUM WIRE SIZE* (GAUGE)	MAXIMUM FUSE OR CIRCUIT BREAKER SIZE (AMPS)
		DIAMETER	HEIGHT		UPPER	LOWER		
153.327164	30	23"	30"	17.3	-	3800	12	20
				25.0	-	5500	10	30
153.327264	40	25"	32½"	17.3	-	3800	12	20
				25.0	-	5500	10	30
153.327363 153.327364	30	19"	45½"	17.3	3800	3800	12	20
				25.0	3800	5500	10	30
153.327463 153.327464	40	19"	59½"	17.3	3800	3800	12	20
				25.0	3800	5500	10	30
153.327563 153.327564	50	21"	57"	17.3	3800	3800	12	20
				25.0	3800	5500	10	30
153.327663 153.327664	66	23"	60½"	17.3	3800	3800	12	20
				25.0	3800	5500	10	30
153.327863 153.327864	82	25"	60½"	17.3	3800	3800	12	20
				25.0	3800	5500	10	30

*Wiring size based on standard 60°C copper wire. If distance from fuse box to water heater is more than 90 feet, refer to your local electrical code.

Preparing for the New Installation

- Read the "Safety Precautions" section, page 2 of this manual first and then the entire manual carefully. If you don't follow the safety rules, the water heater will not operate properly. It could cause DEATH, SERIOUS BODILY INJURY AND/OR PROPERTY DAMAGE.
 This manual contains instructions for the installation, operation, and maintenance of this electric water heater. It also contains warnings throughout the manual that you must read and be aware of. All warnings and all instructions are essential to the proper operation of the water heater and your safety. Since we cannot put everything on the first few pages, READ THIS ENTIRE MANUAL BEFORE ATTEMPTING TO INSTALL OR OPERATE THE WATER HEATER.
- The installation must conform with the instructions in this manual; electric company rules; and Local Codes, or in the absence of Local Codes, with the latest edition of the National Electrical Code. This publication is available from your local government or public library or electric company or by writing Underwriters Laboratories, 333 Pfingsten Road, Northbrook, IL 60062.
- If after reading this manual you have any questions or do not understand any portion of the instructions, call Sears Service Center.
- Carefully plan the place where you are going to put the water heater. Correct electrical wiring and connections are very important in preventing death from possible electrical shock and fires.

 Examine the location to ensure the water heater complies with the "Facts to Consider About the Location" section.
- For California installation this water heater must be braced, anchored, or strapped to avoid falling or moving during an earthquake. See instructions for correct installation procedures. Instructions may be obtained from the California office of the State Architect, 400 P Street, Sacramento, CA 95814

Materials and Basic Tools Needed

Materials Needed

To simplify the installation Sears has available the installation parts shown below. You may or may not need all of these materials, depending on your type of installation.

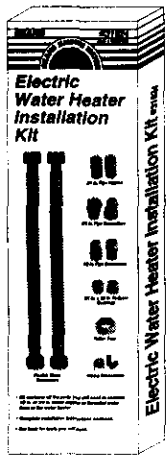

WATER HEATER INSTALLATION KIT WITH FLEXIBLE CONNECTORS FOR 3/4" OR 1/2" THREADED OR COPPER PLUMBING



WATER HEATER HEAT TRAPS HELP REDUCE HEAT LOSS DUE TO THERMAL SYPHONING

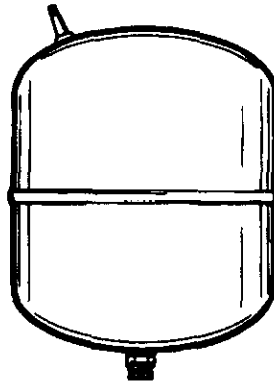

EXPANSION TANKS FOR THERMAL EXPANSION CONDITIONS AVAILABLE IN 2 GALLON AND 5 GALLON CAPACITY THROUGH LOCAL SEARS SERVICE CENTERS

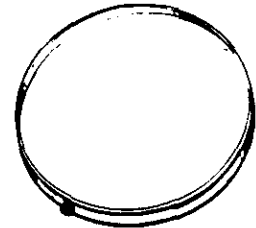

20" DIAMETER DRAIN PAN FOR WATER HEATERS 18" IN DIAMETER AND UNDER

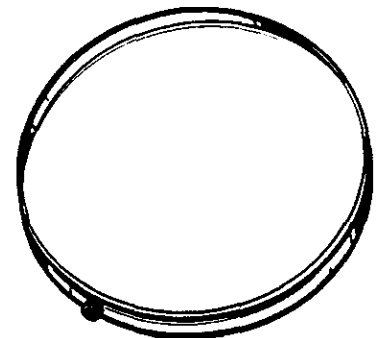

28" DIAMETER DRAIN PAN FOR WATER HEATERS 26" IN DIAMETER AND UNDER

Basic Tools

You may or may not need all of these tools, depending on your type of installation. These tools can be purchased at your local Sears store.

- Pipe Wrench (2)
- Screwdriver
- 6 Foot Tape or Folding Rule
- Garden Hose
- Drill
- Pipe Dope or Teflon Tape



GARDEN HOSE



6 FOOT TAPE



PIPE WRENCH

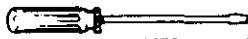

SLOT-HEAD SCREW DRIVER

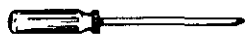

PHILLIPS SCREWDRIVER

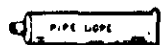

PIPE DOPE (SQUEEZE TUBE)



ROLL OF TEFLON TAPE (Use only on water connections)

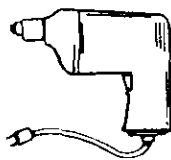

DRILL

ADDITIONAL TOOLS NEEDED WHEN SWEAT SOLDERING

- Tubing Cutters or Hacksaw
- Propane Torch
- Soft Solder
- Solder Flux
- Emery Cloth
- Wire Brushes

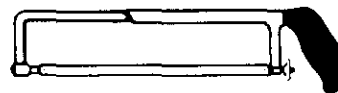

HACKSAW



3/4" WIRE BRUSH



1/2" WIRE BRUSH



ROLL OF LEAD FREE SOFT SOLDER



ROLL OF EMERY CLOTH



SOLDER FLUX



PROPANE TORCH



TUBING CUTTER

Installation Instructions

Removing the Old Water Heater

- ① Turn "OFF" electrical supply to the water heater.

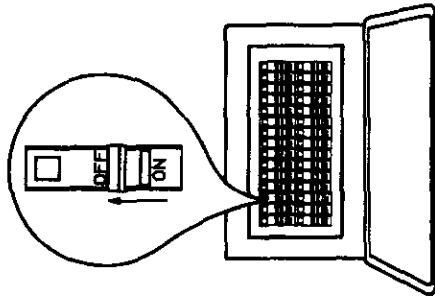

- ② Turn "OFF" the water supply to the water heater at the water shutoff valve or water meter.

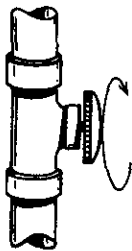

- ③ Attach a hose to the water heater drain valve and put the other end in a floor drain or outdoors. Open the water heater drain valve. Open a nearby hot water faucet which will relieve pressure in the water heater and speed draining.

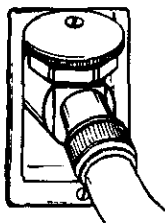

▲ WARNING

The water passing out of the drain valve may be extremely hot. To avoid being scalded, make sure all connections are tight and that the water flow is directed away from any person.

- ④ Check again to make sure the electrical supply is turned "OFF" to the water heater. Then disconnect the electrical supply connection from the water heater junction box.

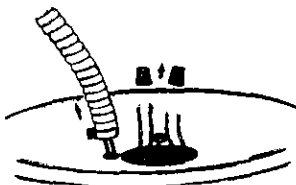

- ⑤ a. If you have copper piping to the water heater, the two copper water pipes can be cut with a hacksaw approximately 4" away from where they connect to the water heater. This will avoid cutting off the pipes too short. Additional cuts can be made later if necessary. Disconnect the temperature-pressure relief valve drain line. When the water heater is drained, disconnect the hose from the drain valve. Close the drain valve. The water heater is now completely disconnected and ready to be removed.

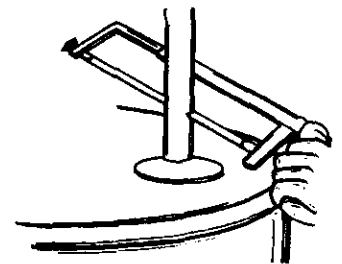
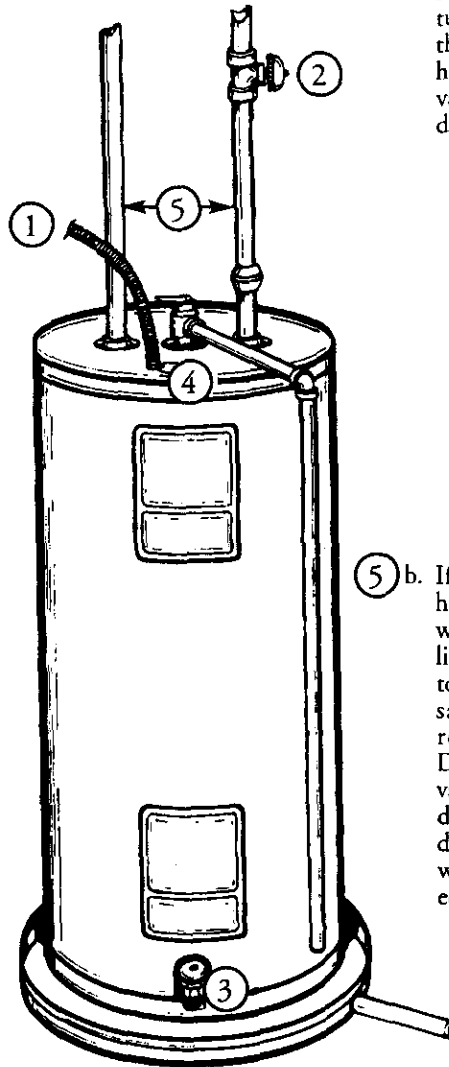

- ⑤ b. If you have galvanized pipe to the water heater, loosen the two galvanized pipes with a pipe wrench at the union in each line. Also disconnect the piping remaining to the water heater. These pieces should be saved since they may be needed when reconnecting the new water heater. Disconnect the temperature-pressure relief valve drain line. When the water heater is drained, disconnect the hose from the drain valve. Close the drain valve. The water heater is now completely disconnected and ready to be removed.

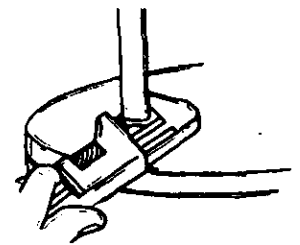

▲ WARNING

Mineral buildup or sediment may have accumulated in the old water heater. This causes the water heater to be much heavier than normal and this residue, if spilled out, could cause staining.

Installation Instructions (cont'd)

Facts to Consider About the Location

You should carefully choose an indoor location for the new water heater, because the placement is a very important consideration for the safety of the occupants in the building and for the most economical use of the appliance. This water heater is not intended for outdoor installation.

Whether replacing an old water heater or putting the water heater in a new location, the following critical points must be observed.

- The location selected should be indoors as close to and as centralized with the water piping system as possible. This water heater, as well as all water heaters, will eventually leak. Do not install without adequate drainage provisions where water flow will cause damage.

▲ CAUTION

WATER HEATERS EVENTUALLY LEAK: Installation of the water heater must be accomplished in such a manner that if the tank or any connections should leak, the flow of water will not cause damage to the structure. When such locations cannot be avoided, a suitable drain pan should be installed under the water heater. Drain pans are available at your local Sears stores. Such a drain pan must be piped to an adequate drain. Under no circumstances is the manufacturer or Sears to be held liable for any water damage in connection with this water heater.

▲ CAUTION

INSTALLATION IN RESIDENTIAL GARAGES: The water heater must be located and/or protected so it is not subject to physical damage by a moving vehicle.

- The location selection must provide adequate clearances for servicing and proper operation of the water heater.

Facts to Consider About The Convertible Lower Element

The Upper Element (if a double element model), is a conventional 3800 watt element which only operates at its rated wattage on 240 volts. (See rating plate on water heater).

The Lower Element of the water heater can be converted from operation at 3800 watts to 5500 watts on a 240 volt system.

Read and follow water heater warnings and instructions. If after reading these instructions in this manual, if you do not understand any portion, call Sears Service Center.

▲ WARNING

Before making the conversion to 5500 watts, check the (1) power supply...must be 240 volts, (2) wiring...10 gauge AWG, Type TW, 60°C or equivalent, and (3) Circuit breakers or fusing...capable of 30 amp loading. Also, the installation must conform with this manual, local codes and electric utility rules. Failure to comply can result in **DEATH, SERIOUS BODILY INJURY, OR PROPERTY DAMAGE.**

ELECTRIC WATER HEATER					ECO INSTALLED
IN CORRESPONDENCE RE- GARDING THIS HEATER AL- WAYS MENTION MODEL & SERIAL NO'S.		UL		LISTED 1949	
MODEL NUMBER		CAPACITY		SERIAL NUMBER	
					U.S. GAL.
FACTORY EQUIPPED WITH					
UPPER ELEMENT	LOWER ELEMENT	MAXIMUM	VOLTS	CHECK (✓) HERE	MANUAL HYDROSTATIC WORKING PRESSURE
				<input checked="" type="checkbox"/>	150
WATTS OPTIONAL WATTAGE	WATTS LOWER ELEMENT	WATTS MAXIMUM	A.C. ONLY IF INSTALLED AS FACTORY EQUIPPED		P.S.I.
			CHECK (✓) HERE		
WATTS	WATTS	WATTS	IF CONVERTED		WARNING SEE CONVERSION INSTRUCTION

NOTE: Whether or not the element conversion is made the model rating plate must be marked. Using a hard point ink pen, check the appropriate block within the model rating plate, which is located adjacent to the lower access panel.

Installation Instructions (cont'd)

Water Piping

▲ WARNING

HOTTER WATER CAN SCALD: Water heaters are intended to produce hot water. Water heated to a temperature which will satisfy space heating, clothes washing, dish washing, and other sanitizing needs can scald and permanently injure you upon contact. Some people are more likely to be permanently injured by hot water than others. These include the elderly, children, the infirm, or physically/mentally handicapped. If anyone using hot water in your home fits into one of these groups or if there is a local code or state law requiring a certain temperature water at the hot water tap, then you must take special precautions. In addition to using the lowest possible temperature setting that satisfies your hot water needs, a means such as a mixing valve, shall be used at the hot water taps used by these people or at the water heater. Mixing valves are available at plumbing supply or hardware stores. Follow manufacturers instructions for installation of the valves. Before changing the factory setting on the thermostat, read the "Temperature Regulation" section in this manual.

The illustration shows the attachment of the water piping to the water heater. The water heater is equipped with $\frac{3}{4}$ " water connections.

If a water heater is installed in a closed water supply system; such as one having a back-flow preventer, check valve, water meter with a check valve, etc. in the cold water supply; means shall be provided to control thermal expansion. Contact the local utility or local Sears Service Center on how to control this situation.

NOTE: If using copper tubing, solder tubing to an adapter before attaching the adapter to the cold water inlet connection. Do not solder the cold water supply line directly to the cold water inlet. It will harm the dip tube and damage the tank.

- Look at the top cover of the water heater. The water outlet is marked hot. Put two or three turns of teflon tape around the threaded end of the threaded-to-sweat coupling and around both ends of the $\frac{3}{4}$ " threaded nipple. Using flexible connectors, connect the hot water pipe to the hot water outlet of the water heater.
- Look at the top cover of the water heater. The cold water inlet is marked cold. Put two or three turns of teflon tape around the threaded end of the threaded-to-sweat coupling and around both ends of the $\frac{3}{4}$ " threaded nipple. Using flexible connectors, connect the cold water pipe to the cold water inlet of the water heater.

NOTE: Your water heater is super insulated to minimize heat loss from the tank. Further reduction in heat loss can be accomplished by insulating the hot water lines from the water heater.

Installation completed using Sears Installation Kit

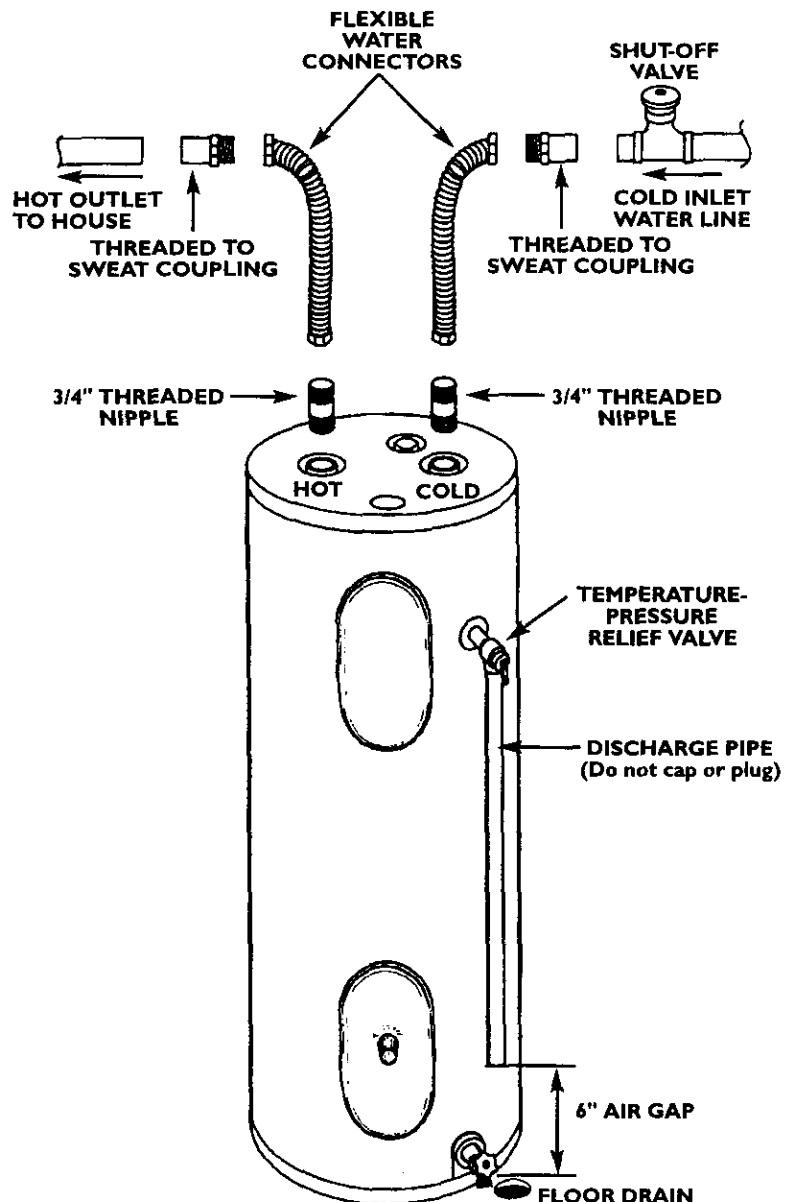

Installation Instructions (cont'd)

Temperature-Pressure Relief Valve

▲ WARNING

At the time of manufacture this water heater was provided with a combination temperature-pressure relief valve certified by a nationally recognized testing laboratory that maintains periodic inspection of production of listed equipment or materials, as meeting the requirements for Relief Valves and Automatic Gas Shutoff Devices for Hot Water Supply Systems, and the latest edition of ANSI Z21.22 and the code requirements of ASME. If replaced, the valve must meet the requirements of local codes, but not less than a combination temperature and pressure relief valve certified as meeting the requirements for Relief Valves and Automatic Gas Shutoff Devices for Hot Water Supply Systems, ANSI Z21.22 by a nationally recognized testing laboratory that maintains periodic inspection of production of listed equipment or materials.

The valve must be marked with a maximum set pressure not to exceed the marked hydrostatic working pressure of the water heater (150 lbs./sq. in.) and a discharge capacity not less than the water heater input rate as shown on the model rating plate. (Electric heaters - watts divided by 1000 x 3415 equal BTU/Hr. rate.)

Your local jurisdictional authority, while mandating the use of a temperature-pressure relief valve complying with ANSI Z21.22 and ASME, may require a valve model different from the one furnished with the water heater.

Compliance with such local requirements must be satisfied by the installer or end user of the water heater with a locally prescribed temperature-pressure relief valve installed in the designated opening in the water heater in place of the factory furnished valve.

For safe operation of the water heater, the relief valve must not be removed from its designated opening or plugged.

The temperature-pressure relief valve must be installed directly into the fitting of the water heater designated for the relief valve. Position the valve downward and provide tubing so that any discharge will exit only within 6 inches above, or at any distance below the structural floor. Be certain that no contact is made with any live electrical part. The discharge opening must not be blocked or reduced in size under any circumstances. Excessive length, over 30 feet, or use of more than four elbows can cause restriction and reduce the discharge capacity of the valve.

No valve or other obstruction is to be placed between the relief valve and the tank. Do not connect tubing directly to discharge drain unless a 6" air gap is provided. To prevent bodily injury, hazard to life, or property damage, the relief valve must be allowed to discharge water in quantities should circumstances demand. If the discharge pipe is not connected to a drain or other suitable means, the water flow may cause property damage.

The Discharge Pipe:

- Must not be smaller in size than the outlet pipe size of the valve, or have any reducing couplings or other restriction.
- Must not be plugged or blocked.
- Must be of material listed for hot water distribution.
- Must be installed so as to allow complete drainage of both the temperature-pressure relief valve, and the discharge pipe.
- Must terminate at an adequate drain.
- Must not have any valve between the relief valve and tank.

▲ WARNING

The temperature-pressure relief valve must be manually operated at least once a year. Caution should be taken to ensure that (1) no one is in front of or around the outlet of the temperature-pressure relief valve discharge line, and (2) the water manually discharged will not cause any bodily injury or property damage because the water may be extremely hot.

If after manually operating the valve, it fails to completely reset and continues to release water, immediately, close the cold water inlet to the water heater, follow the draining instructions, and replace the temperature-pressure relief valve with a new one.

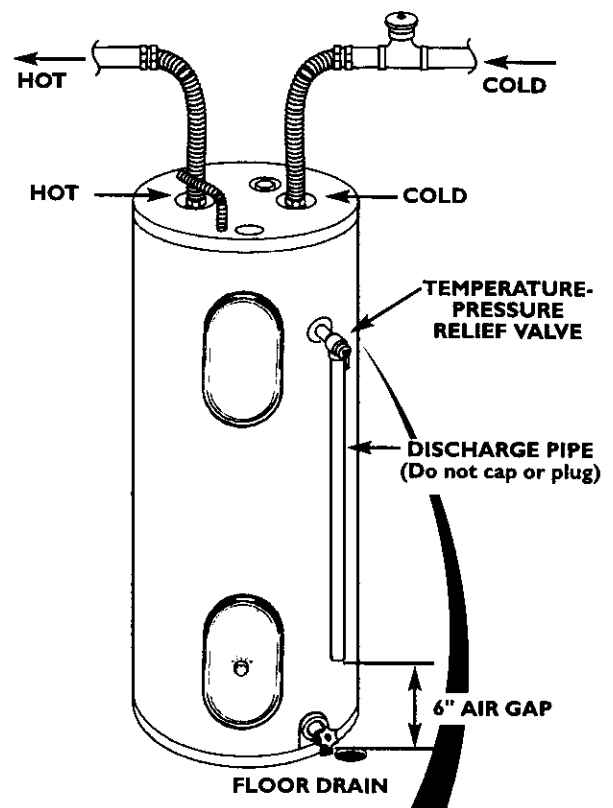

WARNING "RELIEF VALVE OPENING"

This water heater is provided with a combination Temperature-Pressure Relief Valve listed as complying with the standard for Relief Valves and Automatic Gas Shutoff Devices for Hot Water Supply Systems, ANSI Z21.22 and the code requirements of ASME.

Your local jurisdictional authority, while mandating the use of a Temperature-Pressure Relief Valve complying with ANSI Z21.22 and ASME, may require a valve model different from the one furnished with the water heater. Compliance with such local requirements must be satisfied by the installer or end user of the water heater with a locally prescribed Temperature-Pressure Relief Valve installed in the designated opening in the water heater.

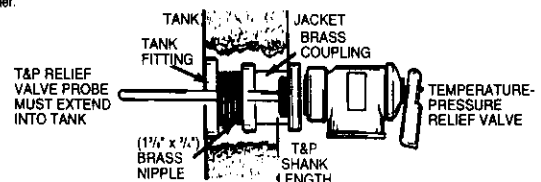

- If a short shank (less than 2") temperature-pressure relief valve is to be installed (as shown), a nipple and coupling must be used.
- If a long shank (2" or longer) is to be installed, do not use the nipple and coupling.

Install Temperature-Pressure protective equipment required by local codes, but not less than a combination Temperature-Pressure Relief Valve certified as meeting the requirements for Relief Valves and Automatic Gas Shutoff Devices for Hot Water Supply Systems, ANSI Z21.22 by a nationally recognized testing laboratory that maintains periodic inspection of production of listed equipment or materials. The valve must be oriented, provided with tubing, or otherwise installed so that discharge can exit only within 6 inches above, or at any distance below the structural floor, and cannot contact any live electrical part.

For safe operation of the water heater, the Relief Valve must not be removed or plugged. See manual heading - "Temperature-Pressure Relief Valve" for installation and maintenance of Relief Valve, discharge pipe and other safety precautions.

Installation Instructions (cont'd)

Filling the Water Heater

To fill the water heater with water:

- Close the water heater drain valve by turning the handle to the right (clockwise). The drain valve is on the lower front of the water heater.
- Open the cold water supply valve to the water heater.
NOTE: The cold water supply valve must be left open when the water heater is in use.
- To insure complete filling of the tank, allow air to exit by opening the nearest hot water faucet. Allow water to run until a constant flow is obtained. This will let air out of the water heater and the piping.

CAUTION

Never use this water heater unless it is completely full of water. To prevent damage to the tank and heating element, the tank must be filled with water. Water must flow from the hot water faucet before turning "ON" power.

- Check all new water piping for leaks. Repair as needed.

Converting the Lower Element

These instructions only cover the conversion of the convertible element, read this entire manual before attempting to install or operate the water heater. The water heater is factory set to operate at 3800 watts. The lower element can be converted to operate at 5500 watts. Refer to the "Facts to Consider About the Convertible Lower Element" section.

The **Upper Element**, (if a double element model) is a conventional 3800 watt element which only operates at its rated wattage on 240 volts. (See rating plate on water heater).

The **Lower Element** of the water heater can be converted from operation at 3800 watts to 5500 watts on a 240 volt system.

If after reading these instructions and this manual, if you do not understand any portion, call Sears Service Center.

WARNING

Before making the conversion to 5500 watts, check the (1) power supply...must be 240 volts, (2) wiring...10 gauge AWG, Type TW, 60°C or equivalent, and (3) Circuit breakers or fusing...capable of 30 amp loading. Also, the installation must conform with this Manual, local codes and electric utility rules. **FAILURE TO COMPLY CAN RESULT IN DEATH, SERIOUS BODILY INJURY OR PROPERTY DAMAGE.**

ELECTRIC WATER HEATER				ECO INSTALLED
IN CORRESPONDENCE RE- GARDING THIS HEATER AL- WAYS MENTION MODEL & SERIAL NO'S.		UL	LISTED 1994	
MODEL NUMBER	CAPACITY	SERIAL NUMBER		
FACTORY EQUIPPED WITH				U.S. GAL.
UPPER ELEMENT	LOWER ELEMENT	MAXIMUM VOLTS	CHECK (✓) HERE	MAXIMUM HYDROSTATIC WORKING PRESSURE
				150
WATTS OPTIONAL WATTAGE UPPER ELEMENT	WATTS LOWER ELEMENT	WATTS MAXIMUM	A.C. ONLY IF INSTALLED AS FACTORY EQUIPPED CHECK (✓) HERE	P.S.I. WARNING SEE CONVERSION INSTRUCTION
			IF CONVERTED	

NOTE: Whether or not the element conversion is made the model rating plate must be marked. Using a hard point ink pen, check the appropriate block within the model rating plate, which is located adjacent to the lower access panel.

Necessary element conversion parts are located in a small bag contained within the electrical junction box on top of the water heater.

CONVERSION PARTS

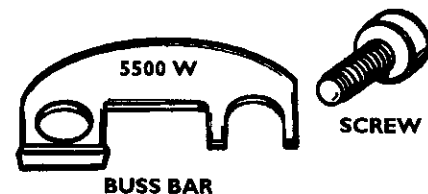

1. Before beginning the conversion turn "OFF" electric power supply to the water heater.

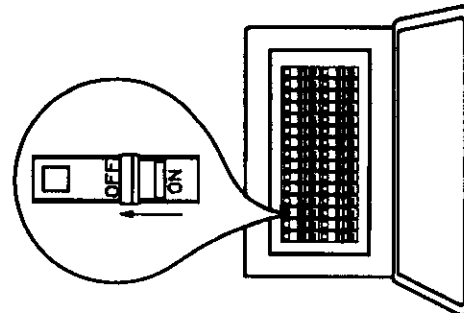

WARNING

HAZARD OF ELECTRICAL SHOCK! Before removing any access panels or servicing the water heater, make sure the electrical supply to the water heater is turned "OFF". **FAILURE TO DO THIS COULD RESULT IN DEATH, SERIOUS BODILY INJURY, OR PROPERTY DAMAGE.**

Installation Instructions (cont'd)

2. The convertible element is located behind the lower access panel of the water heater. Remove the two screws securing the access panel, and remove panel.

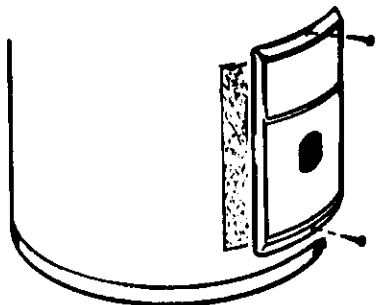

3. Remove the insulation block to expose the opening.

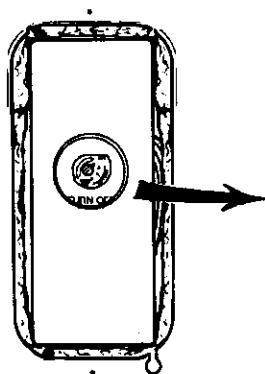

4. **Lower Element:** Lift out the tab as shown to unclip the terminal cover from the thermostat. The terminal cover can now be removed from the thermostat.

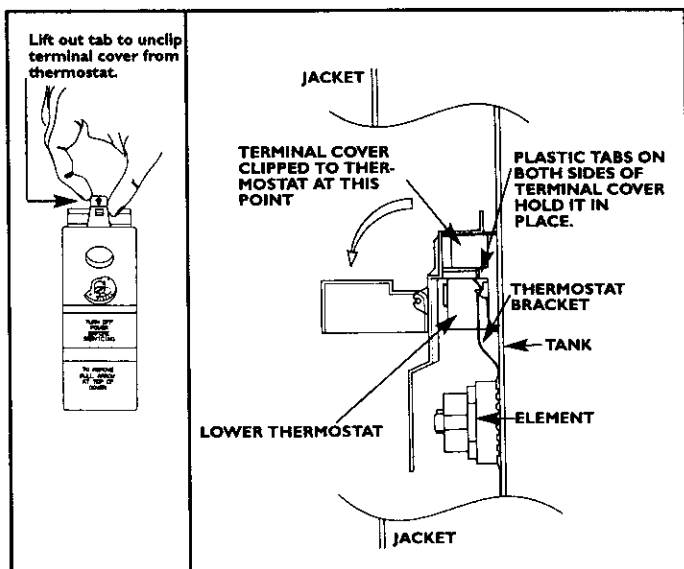

5. Remove the screws from terminal 2 of the element, and move the looped end of the wire aside.

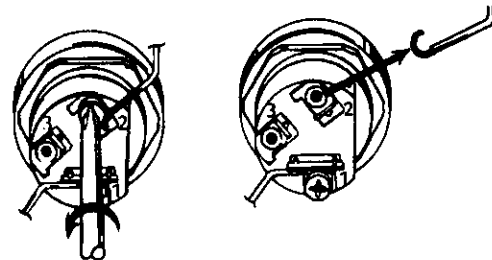

6. The buss bar is labeled 5500 W. Place the buss bar over terminals 2 and 3 with the 5500 W visible. Install the extra screw provided into terminal 3.

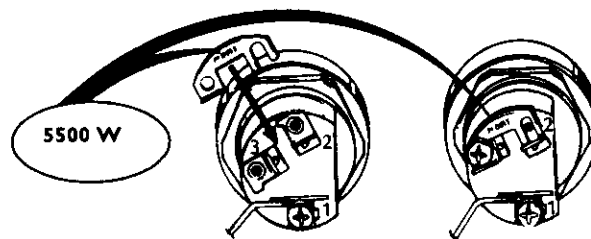

7. The wire removed from terminal 2 has a looped end. It must remain looped and now be placed (as shown) on top of the buss bar, over the opening of terminal 2, and secured using the remaining screw.



8. Tighten terminals 2 and 3 to ensure proper electrical connection.

⚠ WARNING

Failure to tighten terminal screws can cause a fire which can result in DEATH, SERIOUS BODILY INJURY, OR PROPERTY DAMAGE.

Installation Instructions (cont'd)

Converting the Lower Element (cont'd)

9. Replace terminal cover on thermostat making sure that the locking tabs on the terminal cover are in place.

▲ WARNING

Make sure the thermostat is flush against the tank, the terminal cover is in place, and the insulation is replaced. Failure to do so can result in **DEATH, SERIOUS BODILY INJURY, OR PROPERTY DAMAGE.**

10. Replace the insulation block so that it completely covers the thermostat and element.

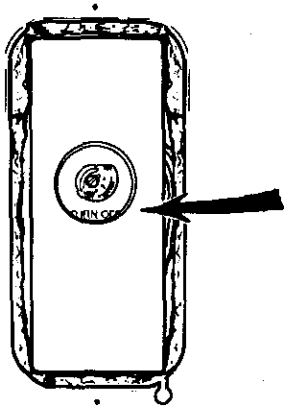

11. Replace the access panel.

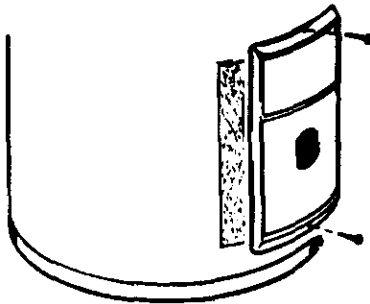

12. Complete wiring to the water heater, or if completed, turn "ON" electric power to the water heater after filling the tank with water.

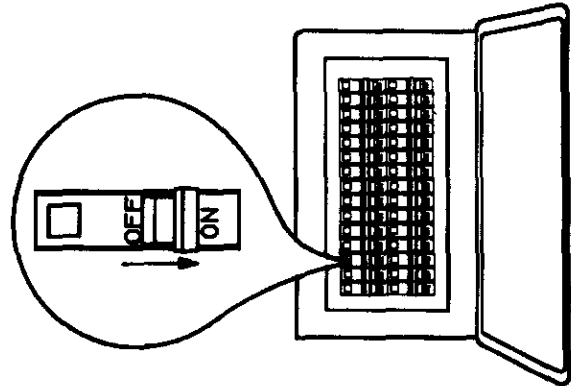

▲ CAUTION

Never use this water heater unless it is completely full of water. To prevent damage to the tank and heating element, the tank must be filled with water. Water must flow from the hot water faucet before turning "ON" power.

Installation Instructions (cont'd)

Wiring Diagrams

STANDARD WIRING FOR
2 WIRE LEAD WATER HEATERS
240 VOLT SINGLE ELEMENT

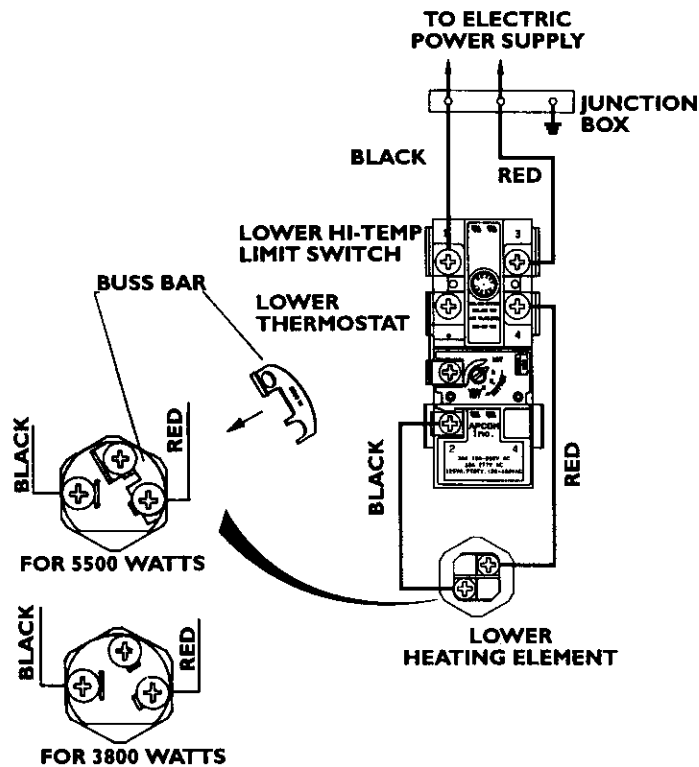

STANDARD WIRING FOR
2 WIRE LEAD WATER HEATERS
NON-SIMULTANEOUS OPERATION
240 VOLT DOUBLE ELEMENT

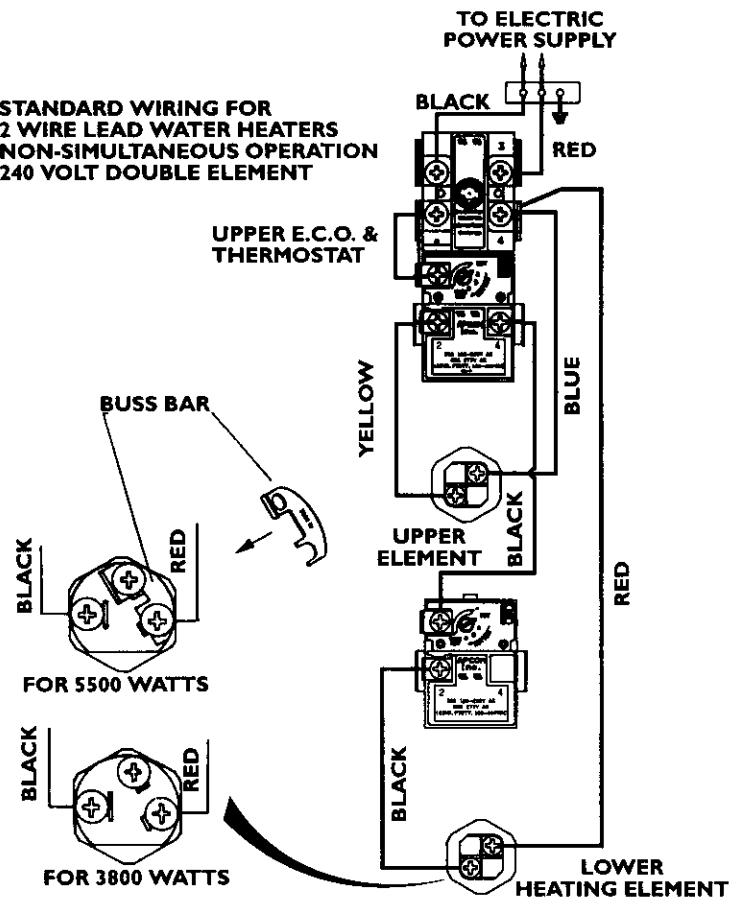

WIRING FOR 3 WIRE LEAD WATER HEATERS
NON-SIMULTANEOUS OPERATION
240 VOLT DOUBLE ELEMENT

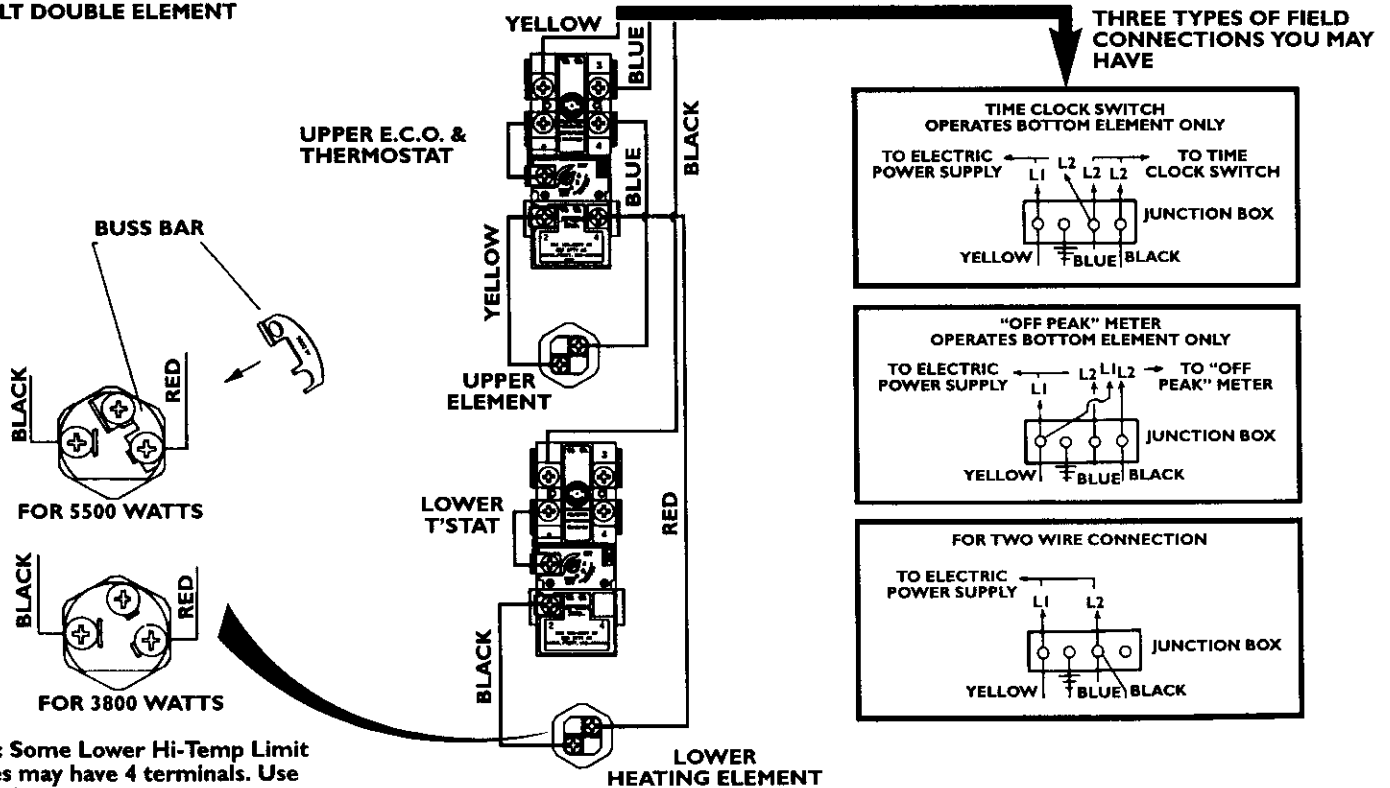

*NOTE: Some Lower Hi-Temp Limit Switches may have 4 terminals. Use only the 2 terminals on left.

Installation Instructions (cont'd)

Wiring

▲ CAUTION

Never use this water heater unless it is completely full of water. To prevent damage to the tank and heating element, the tank must be filled with water. Water must flow from the hot water faucet before turning on power.

You must provide all wiring of the proper size outside of the water heater. You must obey local codes and electric company requirements when you install this wiring.

If you are not familiar with electric codes and practices, or if you have any doubt, even the slightest doubt, in your ability to connect the wiring to this water heater, obtain the service of a competent electrician. Contact your Sears salesperson to arrange for a professional electrician.

▲ WARNING

WATER HEATERS EQUIPPED FOR ONE VOLTAGE ONLY: This water heater is equipped for one type voltage only. Check the rating plate near the bottom access panel for the correct voltage. **DO NOT** use this water heater with any voltage other than the one shown on the model rating plate. Failure to use the correct voltage can cause problems which can result in **DEATH, SERIOUS BODILY INJURY, OR PROPERTY DAMAGE.** If you have any questions or doubts consult your electric company.

▲ CAUTION

If wiring from your fuse box or circuit breaker box was aluminum for your old water heater, replace it with copper wire. If you wish to reuse the existing aluminum wire, have the connection at the water heater made by a competent electrician. Contact your Sears salesperson to arrange for a professional electrician.

1. Provide a way to easily shut off the electric power when working on the water heater. This could be with a circuit breaker or fuse block in the entrance box or a separate disconnect switch.
2. Install and connect a circuit directly from the main fuse or circuit breaker box. This circuit must be the right size and have its own fuse or circuit breaker. Refer to the chart in the "Product Specifications" section for the correct size wire and fuse or circuit breaker.
3. If metal conduit is used for the grounding conductor:
 - A. The grounding electrode conductor shall be of copper, aluminum, or copperclad aluminum. The material shall be of one continuous length without a splice or joint.
 - B. Rigid metal conduit, intermediate metal conduit, or electrical metallic tubing may be used for the grounding means if conduit or tubing is terminated in fittings approved for grounding.

C. Flexible metal conduit or flexible metallic tubing shall be permitted for grounding if all the following conditions are met:

1. The length in any ground return path does not exceed 6 feet.
2. The circuit conductors contained therein are protected by overcurrent devices rated at 20 amperes or less.
3. The conduit or tubing is terminated in fittings approved for grounding.

For complete grounding details and all allowable exceptions, refer to the latest edition of the National Electrical Code.

4. A standard 1/2" conduit opening has been made in the water heater junction box for the conduit connection.
5. Wiring Diagrams (See Wiring Diagrams Section) have been supplied showing the two most common types of connections between the water heater and the power supply. You can easily see which type connection you have by removing the junction box cover on top of the water heater.

A. Two Wire Connection Diagrams: is the most common requiring you to simply connect red to red, black to black, and the ground wire to the green ground screw in the junction box of the water heater.

B. Three Wire Connection Diagram: is used when you are connecting the water heater to power a supply that has a "Time Clock" or "Off Peak" Meter. To make these connections refer to block 1 or 2 in this wiring diagram for the type of system you have.

NOTE: If you have purchased a three wire connection water heater but you are not on a "Time Clock" or "Off Peak" meter and have a standard two wire connection power supply, simply follow the connection diagram in block 3 of the Three Wire Connection Diagram.

6. Use wire nuts and connect the power supply wiring to the wires inside the water heater's junction.
7. The water heater must be electrically "grounded" by the installer. A green ground screw has been provided on the water heater's junction box. Connect ground wire to this location.
8. Replace the wiring junction cover using the screw provided.

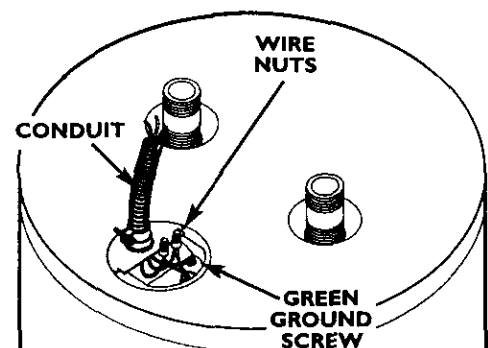

Installation Instructions (cont'd)

Installation Checklist

- Whether or not the element conversion is made, the model rating plate must be marked. Using a hard point ink pen, check the appropriate block within the model rating plate, which is located adjacent to the lower access panel.
- Is the fuse or circuit breaker size correct as shown in the chart in the "Product Specifications" section?
- Are the wires from the circuit breaker or fuse service to the water heater's junction box on the correct wire size (gauge) as shown in the chart in the "Product Specifications" section?
- Is the new temperature-pressure relief valve properly installed, and piped to an adequate drain? See "Temperature-Pressure Relief Valve" section.
- Is the water heater completely filled with water? See "Filling the Water Heater" instructions in the "Installation Instructions" section.
- Will a water leak damage anything? See "Facts to Consider About the Location" section.
- Are the cold and hot water lines connected to the water heater correctly? See "Water Piping" instructions in the "Installation Instructions" section.
- Is there adequate clearance for maintenance around the water heater?
- Do you need to call your electric company to check your wiring?

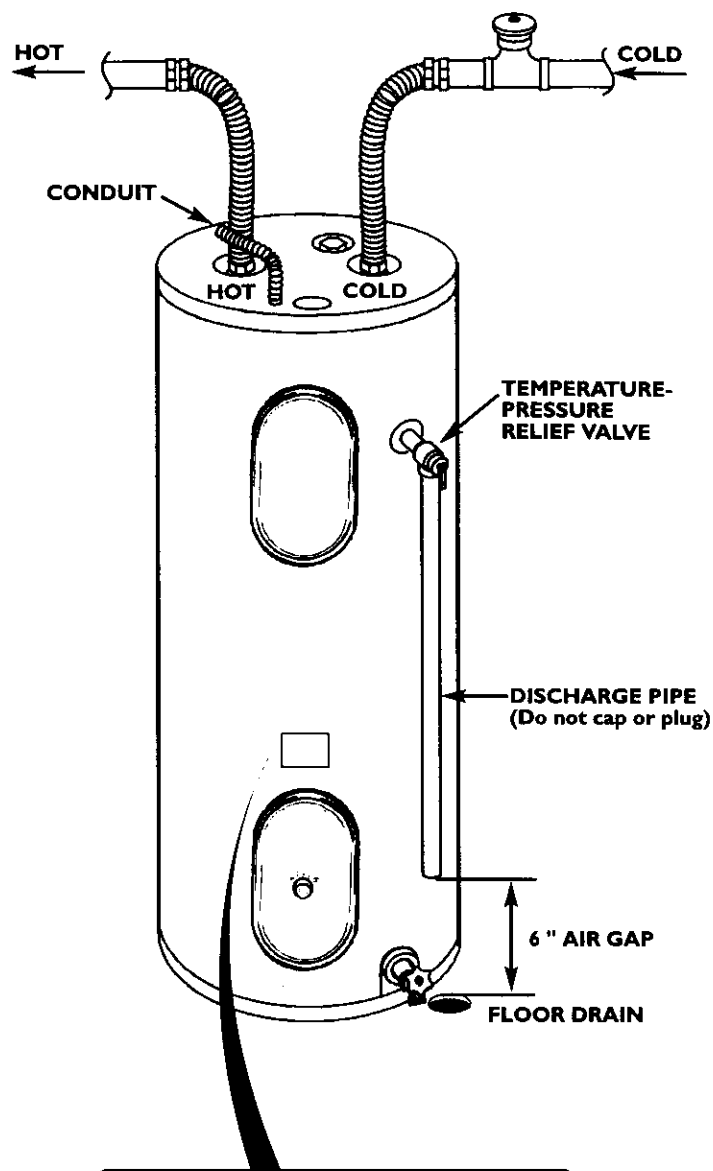

ELECTRIC WATER HEATER				ECO
IN CONFORMANCE WITH		UL LISTED		INSTALLED
SAFETY THIS HEATER AL-		TYPE		
WAYS SECTION MODEL &		CAPACITY		SERIAL NUMBER
SERIAL NO.		MODEL NUMBER		
FACTORY EQUIPPED WITH				U.S. GAL.
UPPER	LOWER	MEDIUM	VOLTS	CHECK (✓) HERE
				150
WATTS	WATTS	WATTS	A.C. ONLY	IF INSTALLED AS
OPTIONAL	WATTS	WATTS	FACTORY EQUIPPED	P.S.I.
UPPER	LOWER	MEDIUM	CHECK (✓) HERE	
WATTS	WATTS	WATTS	IF CONVERTED	WARNING
				SEE CONVERSION
				INSTRUCTION

MODEL RATING PLATE

Service and Adjustment

Temperature Regulation

▲ WARNING

HOTTER WATER CAN SCALD: Water heaters are intended to produce hot water. Water heated to a temperature which will satisfy space heating, clothes washing, dish washing, and other sanitizing needs can scald and permanently injure you upon contact. Some people are more likely to be permanently injured by hot water than others. These include the elderly, children, the infirm, or physically/mentally handicapped. If anyone using hot water in your home fits into one of these groups or if there is a local code or state law requiring a certain temperature water at the hot water tap, then you must take special precautions. In addition to using the lowest possible temperature setting that satisfies your hot water needs, a means such as a mixing valve, shall be used at the hot water taps used by these people or at the water heater. Mixing valves are available at plumbing supply or hardware stores. Follow manufacturers instructions for installation of the valves. Before changing the factory setting on the thermostat, read the "Temperature Regulation" section in this manual.

▲ WARNING

Never allow small children to use a hot water tap, or to draw their own bath water. Never leave a child or handicapped person unattended in a bathtub or shower.

Thermostats

The thermostat(s) of this water heater have been factory set at their lowest position which approximates 120°F (Hot) to reduce the risk of scald injury.

The upper thermostat (dual element models only) is factory set at its lowest position which approximates 120°F (Hot) and is adjustable if a different water temperature is desired. Read all warnings in this manual and on the water heating before proceeding.

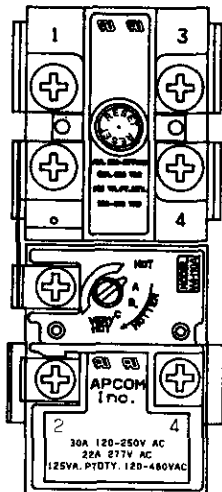

(DUAL ELEMENT MODELS ONLY)
UPPER THERMOSTAT ADJUSTABLE
BEHIND UPPER ACCESS PANEL

The lower thermostat is factory set at its lowest position which approximates 120°F (Hot) and is adjustable if a different water temperature is desired. Read all warnings in this manual and on the water heater before proceeding.

Temperature Settings

HOT—Is a thermostat setting of approximately 120°F, which will supply hot water at the most economical temperatures.

A—Is a thermostat setting of approximately 130°F.

B—Is a thermostat setting of approximately 140°F.

C—Is a thermostat setting of approximately 150°F.

VERY HOT—Is a thermostat setting of approximately 160°F. It is recommended that the dial be set lower whenever possible.

NOTE: Water temperature range of 120°—140°F recommended by most dishwasher manufacturers.

Upper Thermostat Adjustment

NOTE: It is not necessary to adjust the upper thermostat. However, if it is adjusted above the factory set point of 120°F (HOT) it is recommended that it not be set higher than the lower thermostat setting.

The upper thermostat is adjustable if a different water temperature is desired. Read all warnings in the "Temperature-Regulation" section before proceeding.

1. Turn "OFF" the electrical power to the water heater at the junction box.
2. Take "OFF" the access panel.
3. The slotted adjustment (using a screwdriver) can be turned clockwise (↻) to increase the temperature setting or counter clockwise (↻) to decrease the temperature setting.
4. Replace the access panel.
5. Turn "ON" the power supply.

Service and Adjustment (cont'd)

Lower Thermostat Adjustment

The lower thermostat is adjustable if a different water temperature is desired. Read all warnings in the "Temperature-Regulation" section before proceeding.

The slotted adjustment (using a screwdriver) can be turned clockwise (↻) to increase the temperature setting or counter clockwise to (↺) decrease the temperature setting.

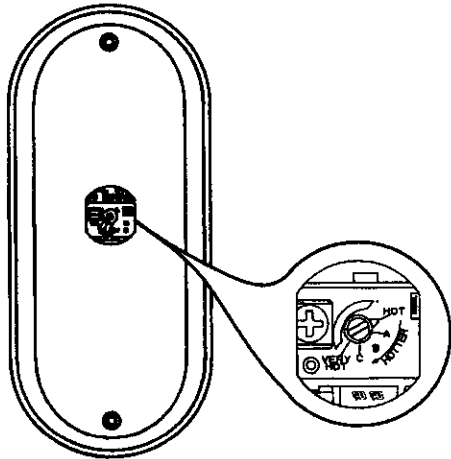

LOWER THERMOSTAT ADJUSTABLE THROUGH LOWER ACCESS PANEL

Temperature-Pressure Relief Valve Operation

The temperature-pressure relief valve must be manually operated at least once a year.

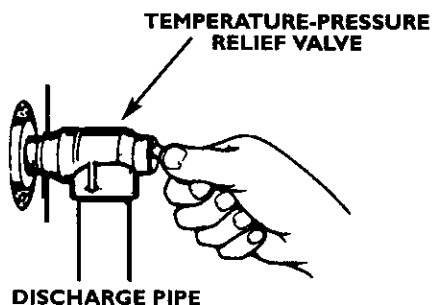

▲ WARNING

The temperature-pressure relief valve must be manually operated at least once a year. Caution should be taken to ensure that (1) no one is in front of or around the outlet of the temperature-pressure relief valve discharge line, and (2) the water manually discharged will not cause any property damage or bodily injury. The water may be extremely hot.

If after manually operating the valve, it fails to completely reset and continues to release water, immediately close the cold water inlet to the water heater, follow the draining instructions, and replace the temperature-pressure relief valve with a new one.

Failure to install and maintain a new properly listed temperature-pressure relief valve will release the manufacturer from any claim which might result from excessive temperature or pressure.

▲ WARNING

If the temperature-pressure relief valve on the appliance weeps or discharges periodically, this may be due to thermal expansion. Your water heater may have a check valve installed in the water line or a water meter with a check valve. Consult your local Sears Service Center for further information. Do not plug the temperature-pressure relief valve.

Draining

The water heater should be drained if being shut down during freezing temperatures. Also periodic draining and cleaning of sediment from the tank may be necessary.

- Before beginning turn "OFF" the electric power supply to the water heater.

▲ WARNING

HAZARD OF ELECTRICAL SHOCK! Before removing any access panels or servicing the water heater, make sure the electrical supply to the water heater is turned "OFF". Failure to do this could result in DEATH, SERIOUS BODILY INJURY, OR PROPERTY DAMAGE.

- CLOSE the cold water inlet valve to the water heater.
- OPEN a nearby hot water faucet and leave open to allow for draining.
- Connect a hose to the drain valve and terminate to an adequate drain or outdoors.
- OPEN the water heater drain valve to allow for tank draining.

NOTE: If the water heater is going to be shut down and drained for an extended period, the drain valve should be left open with hose connected allowing water to terminate to an adequate drain.

- Close the drain valve.
- Follow "Filling the Water Heater" instructions in the "Installation Instructions" section.
- Turn "ON" power to the water heater.

▲ CAUTION

Never use this water heater unless it is completely full water. To prevent damage to the tank and heating element, the tank must be filled with water. Water must flow from the hot water faucet before turning "ON" power.

Service and Adjustment (cont'd)

Element Cleaning/ Replacement

▲ IMPORTANT

ELEMENT REPLACEMENT INFORMATION

This water heater is equipped with a special element that has 1 1/4" threads. Make sure that the replacement element has 1 1/4" threads.

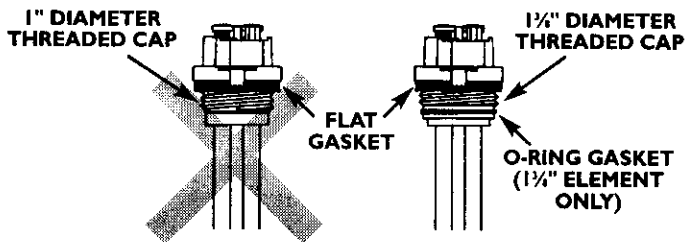

NOTE: These instructions are written for element cleaning and element replacement for the lower element. If it is necessary to clean or replace the upper element, then repeat these instructions.

To remove the element from your tank in order to clean or replace it:

1. Before beginning turn "OFF" the electric power supply to the water heater.

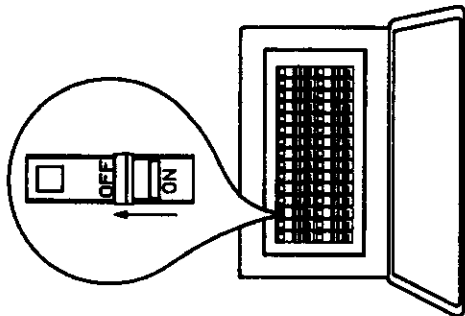

▲ WARNING

HAZARD OF ELECTRICAL SHOCK! Before removing any access panels or servicing the water heater, make sure the electrical supply to the water heater is turned "OFF". Failure to do this could result in **DEATH, SERIOUS BODILY INJURY, OR PROPERTY DAMAGE.**

2. Turn off the water supply to the water heater at the water shutoff valve or water meter.

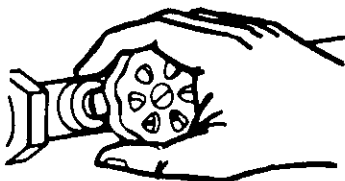

3. Attach a hose to the water heater drain valve and put the other end in a floor drain or outdoors. Open the water heater drain valve. Open a nearby hot water faucet which will relieve pressure in the water heater and speed draining.

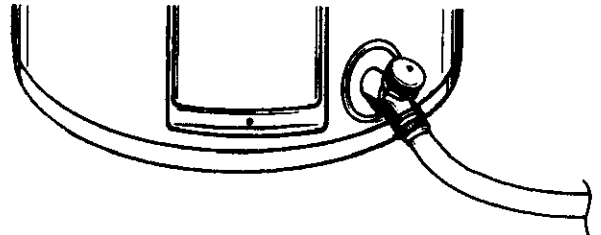

▲ WARNING

The water passing out of the drain valve may be extremely hot. To avoid being scalded, make sure all connections are tight and that the water flow is directed away from any person.

4. Remove the two screws securing the access panel, and remove panel.

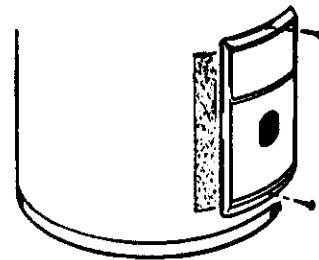

5. Remove the insulation block to expose the opening.

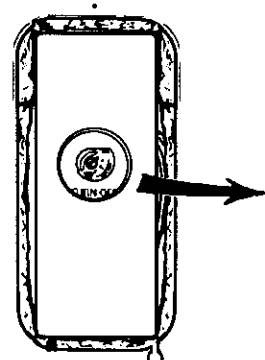

Service and Adjustment (cont'd)

6. Lift out the tab as shown to unclip the terminal cover from the thermostat. The terminal cover can now be removed from the thermostat.

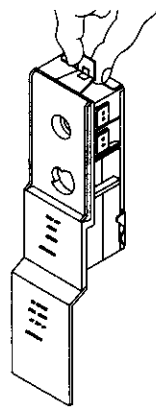
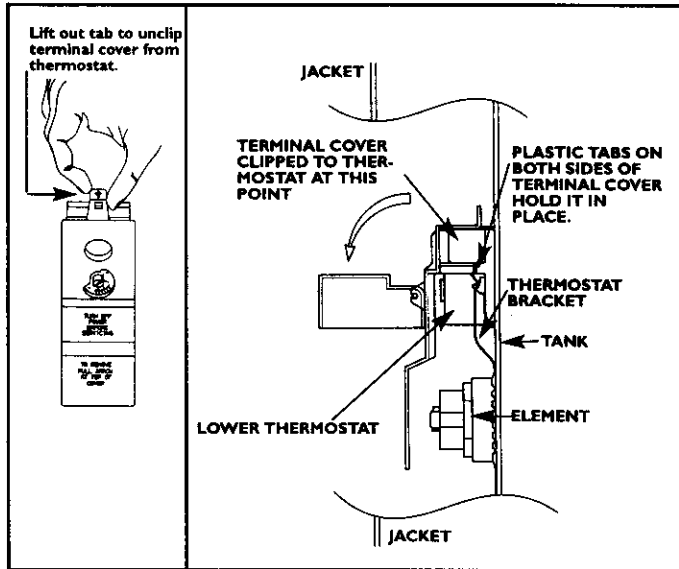

TERMINAL COVER ON UPPER THERMOSTAT

7. Disconnect the two wires on the element and unscrew the old element from the tank.

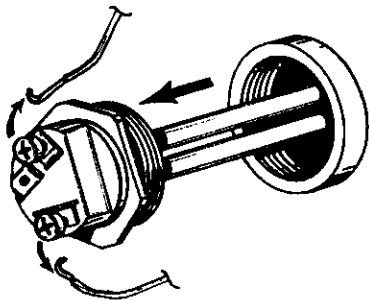

8. Clean the area around the element opening. Remove any sediment from or around the element opening and inside the tank.
9. If you are cleaning the element you have removed, do so by scraping or soaking in vinegar or a de-liming solution.

⚠ WARNING

Replacement elements must (1) be the same voltage and (2) no greater wattage than listed on the model rating plate affixed to the water heater.

10. A new gasket should be used in all cases to prevent a possible water leak. (See Element Gasket in the "Parts Order List" Chart). Place the new element gasket on the thread side of the cleaned or new element and screw into tank, securing tightly using an element wrench.

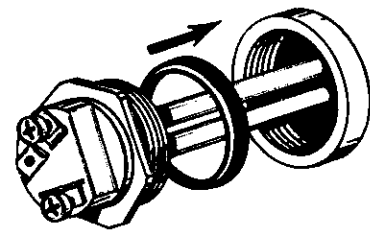

11. Close the water heater drain valve by turning the handle to the right (clockwise). The drain valve is on the lower front of the water heater.
12. Open the cold water supply valve to the water heater.
NOTE: The cold water supply valve must be left open when the water heater is in use.
13. To insure complete filling of the tank, allow air to exit by opening the nearest hot water faucet. Allow water to run until a constant flow is obtained. This will let air out of the water heater and the piping.

⚠ CAUTION

Never use this water heater unless it is completely full of water. To prevent damage to the tank and heating element, the tank must be filled with water. Water must flow from the hot water faucet before turning "ON" power.

14. Check element for water leaks. If leakage occurs, tighten element or repeat steps 2 and 3, remove element and reposition gasket. Then repeat steps 10 through 14.
15. Reconnect the two wires to the element and then check to make sure the thermostat remains firmly against the surface of the tank.

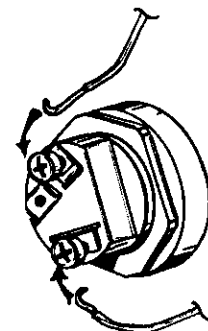

Service and Adjustment (cont'd)

Element Cleaning/ Replacement (cont'd)

16. Replace terminal cover on thermostat making sure that the locking tabs on the terminal cover are in place.
17. Replace the insulation block so that it completely covers the thermostat and element.

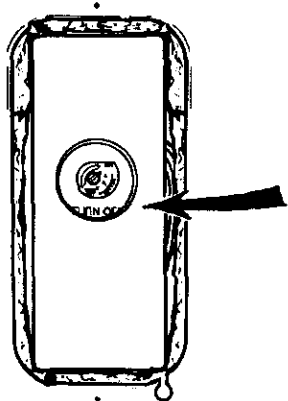

18. Replace access panel.
19. Turn "ON" electric power to water heater.

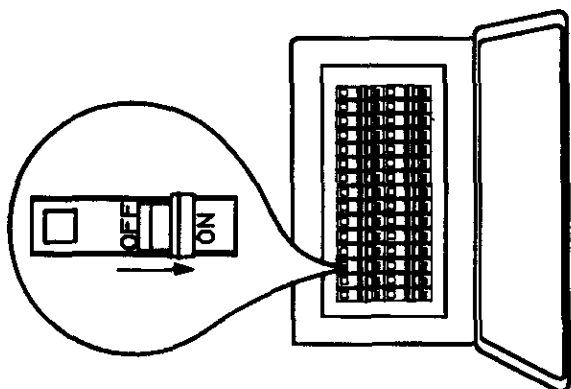

Drain Valve Washer Replacement

NOTE: For replacement, use a $\frac{1}{32}$ " x $\frac{1}{16}$ " x $\frac{1}{8}$ " thick washer available at your nearest hardware store. For ordering a replacement washer, refer to the "Parts Order List" section.

- Before beginning turn "OFF" the electrical power supply to the water heater.

⚠ WARNING

HAZARD OF ELECTRICAL SHOCK! Before removing any access panels or servicing the water heater, make sure the electrical supply to the water heater is turned "OFF". Failure to do this could result in DEATH, SERIOUS BODILY INJURY, OR PROPERTY DAMAGE.

- Follow "Draining" instructions. See "Draining" section.
- Turning counter clockwise, remove the hex cap below the screw handle.
- Remove the washer and put the new one in place.
- Screw the handle and cap assembly back into the drain valve and retighten using a wrench. DO NOT OVER TIGHTEN.
- Follow "Filling the Water Heater" instructions in the "Installation Instructions" section.
- Check for leaks.
- Turn "ON" electric power to the water heater.



Service

Before calling for repair service, read the Start Up Conditions and Operational Conditions found in the Troubleshooting Guide of this manual.

If a condition persists or you are uncertain about the operation of the water heater, let a qualified person check it out.

Contact SEARS Repair Services at 1-800-4-MY-HOME (1-800-469-4663).

Troubleshooting Guide

Start Up Conditions

THERMAL EXPANSION

Water supply systems may, because of such events as high line pressure, frequent cut-offs, the effects of water hammer among others, have installed devices such as pressure reducing valves, check valves, back flow preventers, etc...to control these types of problems. When these devices are not equipped with an internal by-pass, and no other measures are taken, the devices cause the water system to be closed. As water is heated, it expands (thermal expansion) and closed systems do not allow for the expansion of heated water.

The water within the water heater tank expands as it is heated and increases the pressure of the water system. If the relieving point of the water heater's temperature-pressure relief valve is reached, the valve will relieve the excess pressure. **The temperature-pressure relief valve is not intended for the constant relief of thermal expansion.** This is an unacceptable condition and must be corrected.

It is recommended that any devices installed which could create a closed system have a by-pass and/or the system have an expansion tank to relieve the pressure built by thermal expansion. Thermal expansion tanks are available from Sears stores and through the Sears Service Centers. Contact the local plumbing inspector, water supplier and/or the Sears Service Center for assistance in controlling these situations.

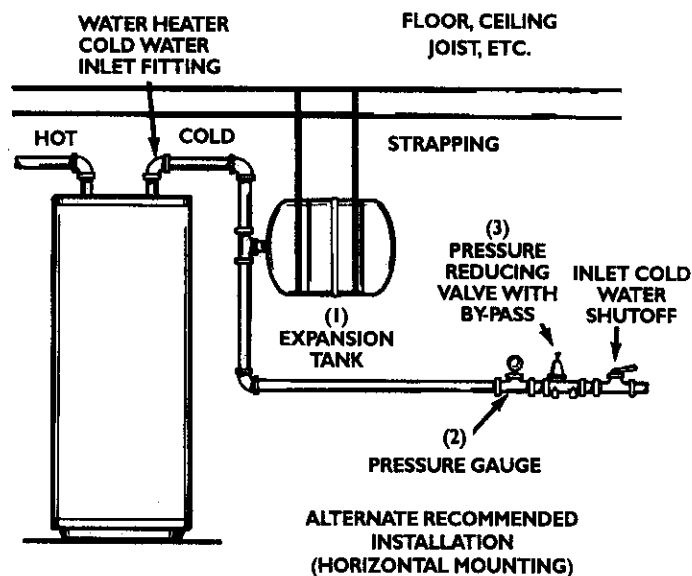
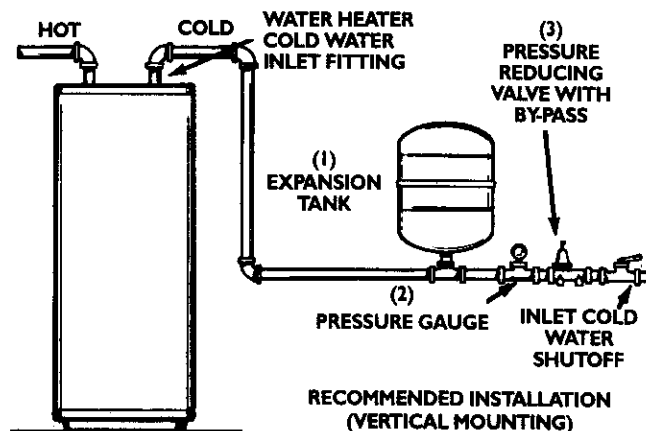

Thermal Expansion Tank Specifications

Model Number	Tank Capacity In Gallons	Dimensions in Inches		Pipe Fitting On Tank
		Diameter	Length	
153.331020	2	8 inches	12¼ inches	¼" Male
153.331050	5	11 inches	14¾ inches	¼" Male

Expansion Tank Sizing Chart

Expansion Tank Capacity Needed	Inlet* Water Pressure	Water Heater Capacity (Gallons)				
		30	40	50	66	82
40psi	2	2	2	2	5	5
50psi	2	2	2	2	5	5
60psi	2	2	2	5	5	5
70psi	2	2	2	5	5	5
80psi	2	5	5	5	5	5

*Highest recorded inlet water pressure in a 24 hour period or regulated water pressure.

NOTE: Expansion tanks are pre-charged with a 40 psi air charge. If the inlet water pressure is higher than 40 psi, the expansion tank's air pressure must be adjusted to match that pressure, but must not be higher than 80 psi.

STRANGE SOUNDS

Possible noises due to expansion and contraction of some metal parts during periods of heat-up and cool-down do not represent harmful or dangerous conditions.

Troubleshooting Guide (cont'd)

Operational Conditions

RUMBLING NOISE

In some water areas, scale or mineral deposits will build up on your heating elements. This buildup will cause a rumbling noise. Follow "Element Cleaning/Replacement" instructions to clean and replace the elements.

HIGH TEMPERATURE SHUT OFF SYSTEM

The water heater has a high limit shut off system with a reset button located in the upper thermostat.

Follow the resetting instructions which refer to the high limit behind the upper access panel.

NOTE: If your water heater is connected to an "OFF PEAK" clock, and uses the "3 wire lead" wiring diagram in the "Wiring Diagram" section, then the water heater will have a hi-limit on both the upper and lower thermostats. Follow the instructions to reset the hi-limit behind the upper and lower access panels.

- Before beginning, turn "OFF" electrical power supply to the water heater.

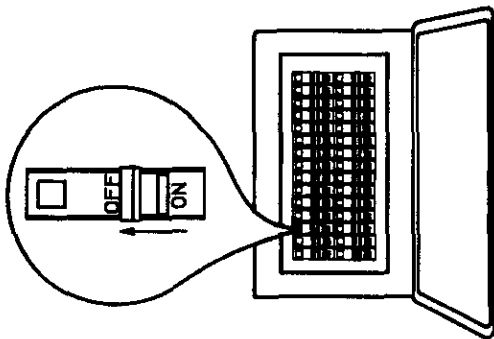

⚠ WARNING

HAZARD OF ELECTRICAL SHOCK! Before removing any access panels or servicing the water heater, make sure the electrical supply to the water heater is turned "OFF". Failure to do this could result in DEATH, SERIOUS BODILY INJURY, OR PROPERTY DAMAGE.

- Remove the two screws securing the access panel and remove panel.
- Remove the insulation block to expose the opening.
- Reset the high limit by pushing in the red button marked "RESET".

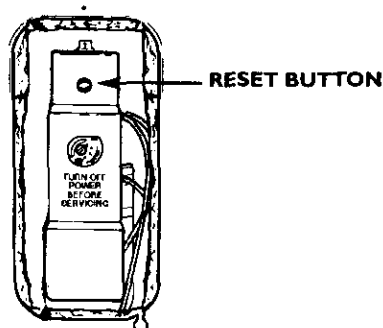

- Replace the insulation block so that it completely covers the thermostat and element.
- Replace the access panel.
- Turn "ON" electric power to the water heater.

⚠ CAUTION

If the high limit must be reset again, call Sears Service Department to find out why the high limit turned "OFF" the electric power.

NOT ENOUGH OR NO HOT WATER

- In a new installation, the water heater may not be properly connected. Make sure the cold water supply valve is open. Review and check piping installation. Make sure that the cold water line is connected to the cold water inlet to the water heater and the hot water line to the hot water outlet on the water heater.
- Make sure the electrical supply to your water heater is "ON".
- Check for loose or blown fuses in your water heater circuit. Circuit breakers weaken with age and may not handle their rated load and should be replaced.
- Make certain the disconnect switch, if used, is in the "ON" position.
- Check to see the electric service to your house has not been interrupted. If this is the case, contact the electric company.
- Are the thermostats set to the desired temperature? See "Temperature Regulation" section.
- If you had experienced very hot water and now no hot water, the problem may be due to the high temperature shut off system. See "High Temperature Shut Off System" in the "Troubleshooting" section.
- During very cold weather, the incoming water will also be colder and it will require a longer time to become heated.
- The hot water usage may exceed the capacity of the water heater. If so, wait for water heater to recover after abnormal demand. Also examine pipes and faucets for possible water leaks.
- If you can not determine the problem, then call the Sears Service Department.

WATER IS TOO HOT

Adjust the thermostat to a lower setting. See the "Temperature Regulation" section.

Troubleshooting Guide (cont'd)

Leakage Checkpoints

Use this guide to check a "Leaking" water heater. Many suspected "Leakers" are not leaking tanks. Often the source of the water can be found and corrected.

If you are not thoroughly familiar with electric codes, the water heater, and safety practices, contact your local Sears Service Center to check the water heater.

- (A) *Condensation may be seen on pipes in humid weather or pipe connections may be leaking.
- (B) Small amounts of water from temperature-pressure relief valve may be due to thermal expansion or high water pressure in your area.
- (C) *The temperature-pressure relief valve may be leaking at the tank fitting.
- (D) The elements may be leaking at the tank fitting.

▲ WARNING

HAZARD OF ELECTRICAL SHOCK! Before removing any access panels or servicing the water heater, make sure the electrical supply to the water heater is turned "OFF". Failure to do this could result in DEATH, SERIOUS BODILY INJURY, OR PROPERTY DAMAGE.

Turn electrical power "OFF", remove access panels and fold back insulation. If leaking around elements, follow proper draining instructions and remove element. Reposition or replace gasket on element. Place element into opening and tighten securely. Then follow "Filling the Water Heater" instructions in the "Installation Instructions" section.

- (E) Water from drain valve may be due to the valve being opened slightly.
- (F) *The drain valve may be leaking at the tank fitting.
- (G) *Water in the water heater bottom or on the floor may be from condensation, loose connections or the temperature-pressure relief valve. DO NOT replace the water heater until a full inspection of all possible water sources is made and necessary corrective steps taken.

Leakage from other appliances, water lines, or ground seepage should also be checked.

NOTE: To check where threaded portion enters tank, insert cotton swab between jacket opening and fitting. If cotton is wet, follow "Draining" instructions in the "Service and Adjustment" section and then remove fitting. Put pipe dope or teflon tape on the threads and replace. Then follow "Filling the Water Heater" instructions in the "Installation Instructions" section.

▲ CAUTION

Read this manual first, then before checking the water heater make sure the electric supply has been turned "OFF", and never turn the electric supply "ON" before the tank is completely full of water.

▲ CAUTION

Never use this water heater unless it is completely full of water. To prevent damage to the tank and heating element, the tank must be filled with water. The water must flow from the hot water faucet before turning "ON" power.

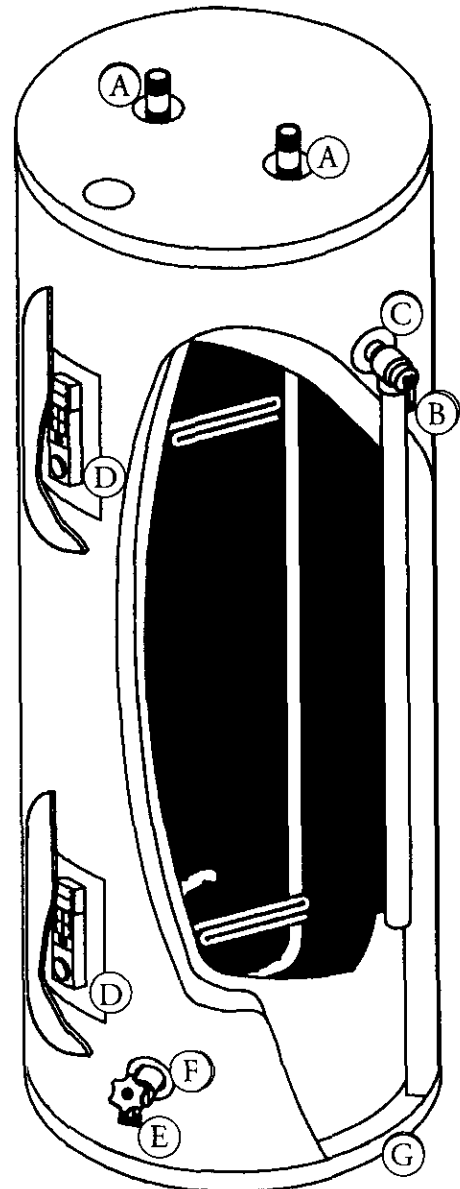

Parts Order List

KENMORE POWER MISER™ 9+ ELECTRIC WATER HEATERS
MODEL NUMBERS:

153.327164 30 Gal. Short
153.327264 40 Gal. Short

NOTE: A

LOWER ELEMENT: These water heaters are equipped with factory installed convertible elements, which can be operated at 3800 watts or 5500 watts. Convertible elements are not offered as replacement parts.



<p>▲ IMPORTANT</p> <p>ELEMENT REPLACEMENT INFORMATION</p> <p>This water heater is equipped with a special element that has 1 3/8" threads. Make sure that the replacement element has 1 3/8" threads.</p>

ELEMENT ORDERING INFORMATION

If a replacement 3800 watt, 240 volt element is needed, order item number 42 32906 replacement element. If at the time of installation, the water heater was converted to operate at 5500 watts, order item number 42 32908 replacement element. (See model rating plate "If Converted" box).

NOTE: B

These water heaters are equipped with a Roto-Swirl™ dip tube (to retard a build-up of dissolved solids) which is not a replaceable item.

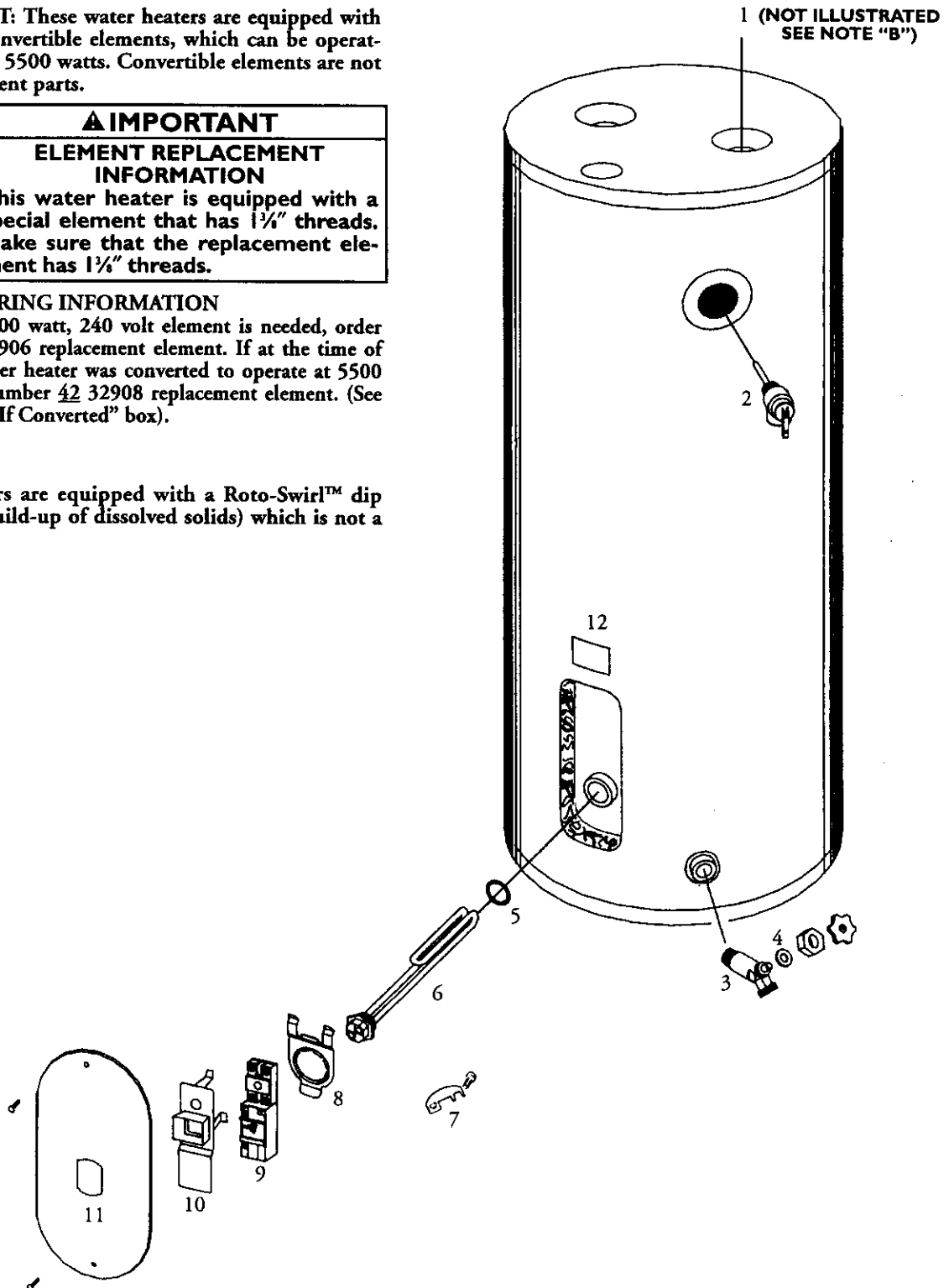

Parts Order List (cont'd)

**KENMORE POWER MISER™ 9+ ELECTRIC WATER HEATERS
MODEL NUMBERS:**

153.327164 30 Gal. Short
153.327264 40 Gal. Short

KEY NO.	PART DESCRIPTION	MODEL NUMBERS	
		153.327164	153.327264
		PART NUMBERS	
1.	Roto-Swirl™ Dip Tube (See NOTE "B" Page 24)	-	-
2.	Temperature-Pressure Relief Valve	<u>42</u> 33085	<u>42</u> 33085
3.	Drain Valve	9001588	9001588
4.	Drain Valve Washer (1/2" x 3/4" x 1/8" thick)**	9001584	9001584
5.	Element Gasket	9000308	9000308
6.	Element* (See NOTE "A" Page 24)	3800 Watt	3800 Watt
		<u>42</u> 32906	<u>42</u> 32906
		5500 Watt	5500 Watt
		<u>42</u> 32908	<u>42</u> 32908
7.	Buss Bar Kit	9001591	9001591
8.	Thermostat Bracket	9000309	9000309
9.	Thermostat w/Hi Limit	<u>42</u> 31918	<u>42</u> 31918
10.	Terminal Cover	9002303	9002303
11.	Access Panel	9001587	9001587
12.	Model Rating Plate †	0270182	0270182
#	Manual	0002915980	

*These parts are also available at most Sears retail stores.

**Also available at most hardware stores.

†Replaced only on return of damaged plate.

#Not Illustrated

Now that you have purchased this water heater, should a need ever exist for repair parts or service, simply contact any SEARS Service Center or call 1-800-4-MY-HOME (1-800-469-4663). Be sure to provide all pertinent facts when you call or visit.

All parts listed may be ordered from any SEARS Service Center, most Sears stores and by calling 1-800-366-PART (1-800-366-7278).

If the parts you need are not stocked locally, your order will be electronically transmitted to a SEARS Repair Parts Distribution Center for handling.

The model number of the water heater will be found on the model rating plate located above the access panel.

WHEN ORDERING REPAIR PARTS, ALWAYS GIVE THE FOLLOWING INFORMATION:

MODEL NUMBER NAME OF PART
PART NUMBER PART DESCRIPTION

THIS IS A REPAIR PARTS LIST, NOT A PACKING LIST.

Parts Order List (cont'd)

KENMORE POWER MISER™ 9+ ELECTRIC WATER HEATERS
MODEL NUMBERS:

153.327363	30 Gal.	153.327564	50 Gal.
153.327364	30 Gal.	153.327663	66 Gal.
153.327463	40 Gal.	153.327664	66 Gal.
153.327464	40 Gal.	153.327863	82 Gal.
153.327563	50 Gal.	153.327864	82 Gal.

NOTE: A

UPPER ELEMENT: These water heaters are equipped with 3800 watt elements.

LOWER ELEMENT: These water heaters are equipped with factory installed convertible elements, which can be operated at 3800 watts or 5500 watts. Convertible elements are not offered as replacement parts.



▲ IMPORTANT

ELEMENT REPLACEMENT INFORMATION

This water heater is equipped with a special element that has 1 3/8" threads. Make sure that the replacement element has 1 3/8" threads.

ELEMENT ORDERING INFORMATION

If a replacement 3800 watt, 240 volt element is needed, order item number 42 32906 replacement element. If at the time of installation, the water heater was converted to operate at 5500 watts, order item number 42 32908 replacement element. (See model rating plate "If Converted" box).

NOTE: B

These water heaters are equipped with a Roto-Swirl™ dip tube (to retard a build-up of dissolved solids) which is not a replaceable item.

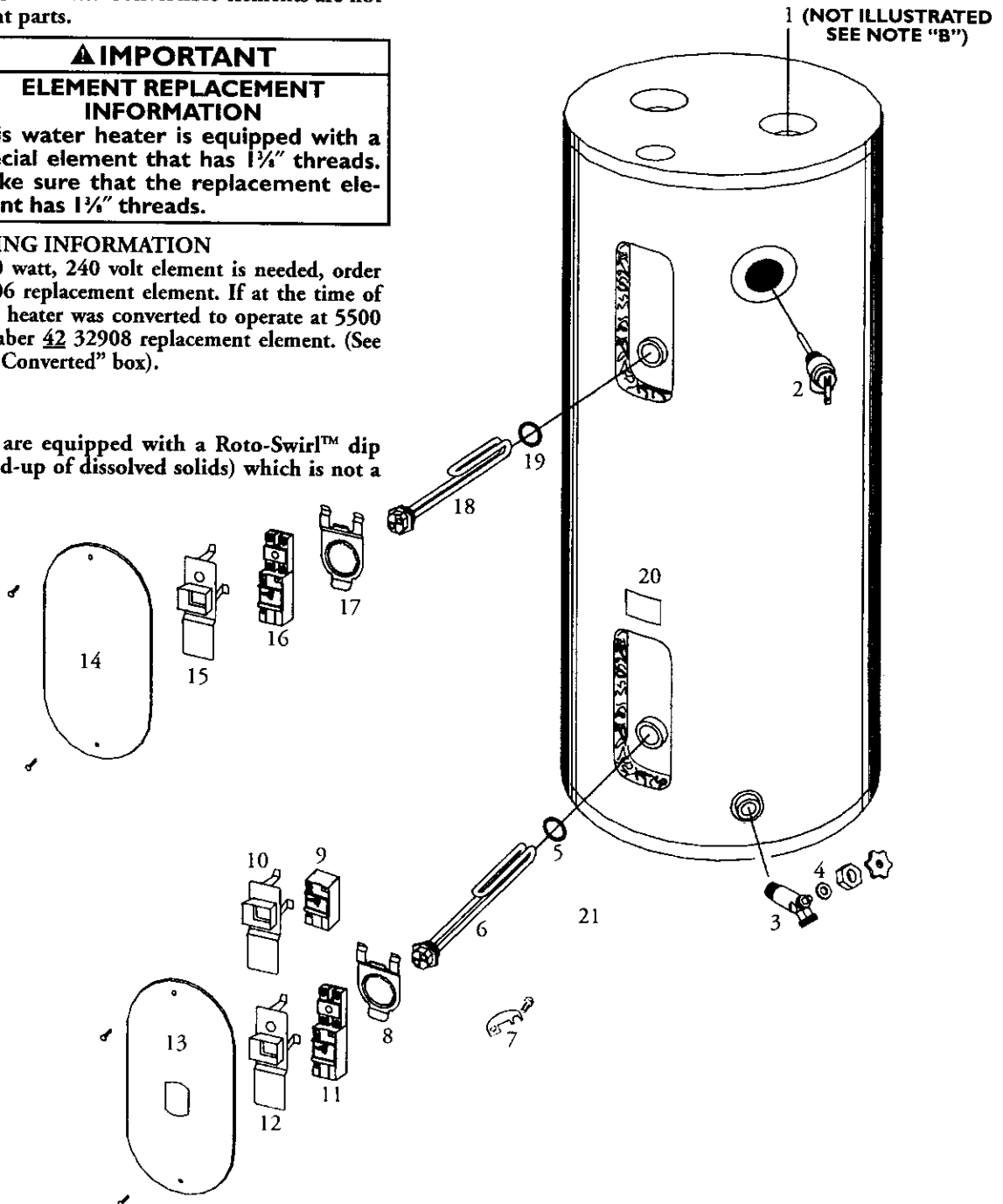

Parts Order List (cont'd)

KENMORE POWER MISER™ 9+ ELECTRIC WATER HEATERS MODEL NUMBERS:

153.327363	30 Gal.	153.327564	50 Gal.
153.327364	30 Gal.	153.327663	66 Gal.
153.327463	40 Gal.	153.327664	66 Gal.
153.327464	40 Gal.	153.327863	82 Gal.
153.327563	50 Gal.	153.327864	82 Gal.

KEY NO.	PART DESCRIPTION	MODEL NUMBERS	
		153.327363	153.327364
		153.327463	153.327464
		153.327563	153.327564
		153.327663	153.327664
		153.327863	153.327864
1.	Roto-Swirl™ Dip Tube # (See NOTE "B" page 26)	—	—
2.	Temperature-Pressure Relief Valve	42 33085	42 33085
3.	Drain Valve	9001588	9001588
4.	Drain Valve Washer (1/2" x 1/4" x 1/8" thick)**	9001584	9001584
5.	Element Gasket	9000308	9000308
6.	Lower Element* (See NOTE "A" page 26)	3800 Watt	3800 Watt
		42 32906	42 32906
		5500 Watt	5500 Watt
		42 32908	42 32908
7.	Buss Bar Kit	9001591	9001591
8.	Thermostat Bracket	9000309	9000309
9.	2 Pole Thermostat (Two Wire Lead Models††)	—	42 31919
10.	Terminal Cover	—	9002276
11.	Lower Thermostat w/Hi Limit (Three Wire Lead Models††)	42 31918	—
12.	Terminal Cover & Barrier	9002303	—
13.	Lower Access Panel	9001587	9001587
14.	Upper Access Panel	9001589	9001589
15.	Terminal Cover	9002303	9002303
16.	Upper Thermostat w/Hi Limit*	42 31917	42 31917
17.	Thermostat Bracket	9000309	9000309
18.	Upper Element* (See NOTE "A" page 26)	42 32906	42 32906
19.	Element Gasket	9000308	9000308
20.	Model Rating Plate †	0270182	0270182
#	Manual	0002915980	

*These parts are also available at most Sears retail stores.

**Also available at most hardware stores.

†Replaced only on return of damaged plate.

††Refer to Wiring Diagram Section for verification.

#Not Illustrated

Now that you have purchased this water heater, should a need ever exist for repair parts or service, simply contact any SEARS Service Center or call 1-800-4-MY-HOME (1-800-469-4663). Be sure to provide all pertinent facts when you call or visit.

All parts listed may be ordered from any SEARS Service Center, most Sears stores and by calling 1-800-366-PART (1-800-366-7278).

If the parts you need are not stocked locally, your order will be electronically transmitted to a SEARS Repair Parts Distribution Center for handling.

The model number of the water heater will be found on the model rating plate located above the access panel.

WHEN ORDERING REPAIR PARTS, ALWAYS GIVE THE FOLLOWING INFORMATION:

MODEL NUMBER NAME OF PART
PART NUMBER PART DESCRIPTION

THIS IS A REPAIR PARTS LIST, NOT A PACKING LIST.

Warranty

About Your Warranty

THE PRICE OF YOUR WATER HEATER DOES NOT INCLUDE A FREE CHECKUP SERVICE CALL. On Water Heater Installations Arranged By Sears, Sears warrants the installation. ON INSTALLATIONS NOT MADE BY SEARS AUTHORIZED CONTRACTORS:

1. Your Sears warranty applies to the product only.
2. Sears does not warrant the installation.
3. A charge will be made on service calls due to poor or incomplete installation. These include:

- a. Adjusting thermostat.
- b. Leaks in pipes or fittings.

This manual is in non-technical language. It may help you avoid the cost of a needless service call. Many service calls really aren't needed. Such as when:

1. The electric power is turned "OFF".
2. A water leak is due to loose pipe or connections.

FULL ONE YEAR WARRANTY ON WATER HEATER

For one year from the date of purchase, when your Sears Kenmore water heater is installed and operated in a single-family residence in accordance with the instructions in this manual, Sears will:

1. Repair defects in material or workmanship in this water heater, free of charge.
2. Furnish and install a new current model water heater of equal capacity and quality, free of charge, if a leak occurs in the tank.

LIMITED WARRANTY ON TANKS THAT LEAK

After one year and through 9 years from the date of purchase for water heaters used in a single-family residence, if a leak occurs in the tank, Sears will furnish a new current model water heater of equal capacity and quality. You will be charged for any installation.

LIMITED WARRANTY ON PARTS

After one year and through 9 years from the date of purchase, when your Sears Kenmore water heater is used in a single-family residence and is installed and operated in accordance with the information in this manual, if a part fails due to a materials or workmanship, Sears will furnish a replacement free of charge. You will be charged for labor.

If the water heater is subjected to commercial, institutional, industrial or use in residences of two families or more, the above warranty coverage for tanks that leak is effective for 2 years from the date of purchase and the above parts warranty is effective for 1 year from the date of purchase.

To obtain warranty service, SIMPLY CALL 1-800-4MY-HOME (1-800-469-4663). "This warranty applies only while this product is in use in the United States."

This warranty gives you specific legal rights and you may also have other rights which vary from state to state.

SEARS, ROEBUCK AND CO., Dept. 817 WA, HOFFMAN ESTATES, IL 60179

Sears Installation Warranty

In addition to any warranty extended to you on the Sears merchandise involved, which warranty becomes effective the date the merchandise is installed should the workmanship of any Sears arranged installation prove faulty within one year, Sears will, upon notice from you, cause such faults to be corrected at no additional cost to you. If you want this heater professionally installed by Sears contact your Sears Salesperson. They will arrange for prompt, quality installation.

Sears Installation Policy

All installation labor arranged by Sears shall be performed in a neat, workmanlike manner in accordance with generally accepted trade practices. Further, all installations shall comply with all local laws, codes regulations and ordinances. The customer shall also be protected, during installation, by insurance relating to property damage, Worker's Compensation and Public Liability.

If you want this water heater professionally installed by Sears contact your Salesperson. They will arrange for prompt, quality installation by Sears authorized contractors.



For in-home major brand repair service
Call 24 hours a day, 7 days a week
1-800-4-MY-HOME
(1-800-469-4663)

The model number of your water heater is found on the model rating plate on the front of the water heater.

Free Manuals Download Website

<http://myh66.com>

<http://usermanuals.us>

<http://www.somanuals.com>

<http://www.4manuals.cc>

<http://www.manual-lib.com>

<http://www.404manual.com>

<http://www.luxmanual.com>

<http://aubethermostatmanual.com>

Golf course search by state

<http://golfingnear.com>

Email search by domain

<http://emailbydomain.com>

Auto manuals search

<http://auto.somanuals.com>

TV manuals search

<http://tv.somanuals.com>