

KENWOOD

MULTIPLE COMPACT DISC PLAYER

CD-224M/DPF-J5010

INSTRUCTION MANUAL

KENWOOD CORPORATION

This unit is designed for home use only. If the unit is used in a location other than at home, such as in a shop (for commercial use), in a car or in a ship, etc., and is damaged, a service fee may be charged even during the warranty period.

This instruction manual is used for two models. Model availability and features (functions) may differ depending on the country and sales area.

COMPACT
disc
DIGITAL AUDIO

B60-3510-08 00 (K, P, Y, T) [AP]

Introduction

CD-224M/DPF-J5010 (En)

2

Before applying power



Caution : Read this section carefully to ensure safe operation.

Units are designed for operation as follows.

U.S.A. and Canada..... AC 120 V only
Australia AC 240 V only

Europe and U.K. AC 230 V only
***Other countries** AC 110-120 / 220-240 V switchable

*AC voltage selection

The AC voltage selector switch on the rear panel is set to the voltage that prevails in the area to which the unit is shipped. Before connecting the power cord to your AC outlet, make sure that the setting position of this switch matches your line voltage. If not, it must be set to your voltage in accordance with the following direction.

Note:
 Our warranty does not cover damage caused by excessive line voltage due to improper setting of the AC voltage selector switch.

AC voltage selector switch

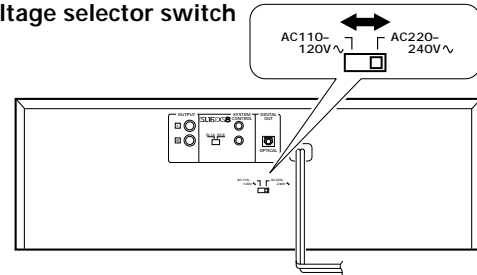

Move switch lever to match your line voltage with a small screwdriver or other pointed tool.

For the United Kingdom

Factory fitted moulded mains plug

1. The mains plug contains a fuse. For replacement, use only a 13-Amp ASTA-approved (BS1362) fuse.
2. The fuse cover must be refitted when replacing the fuse in the moulded plug.
3. Do not cut off the mains plug from this equipment. If the plug fitted is not suitable for the power points in your home or the cable is too short to reach a power point, then obtain an appropriate safety approved extension lead or adapter, or consult your dealer.
 If nonetheless the mains plug is cut off, remove the fuse and dispose of the plug immediately, to avoid a possible shock hazard by inadvertent connection to the mains supply.

IMPORTANT

The wires in the mains lead are coloured in accordance with the following code:
 Blue : Neutral
 Brown : Live
 Do not connect those leads to the earth terminal of a three-pin plug.

Safety precautions



Caution : Read this section carefully to ensure safe operation.

WARNING : TO PREVENT FIRE OR ELECTRIC SHOCK, DO NOT EXPOSE THIS APPLIANCE TO RAIN OR MOISTURE.

	CAUTION RISK OF ELECTRIC SHOCK DO NOT OPEN		CAUTION: TO REDUCE THE RISK OF ELECTRIC SHOCK, DO NOT REMOVE COVER (OR BACK). NO USER-SERVICEABLE PARTS INSIDE. REFER SERVICING TO QUALIFIED SERVICE PERSONNEL.
	THE LIGHTNING FLASH WITH ARROWHEAD SYMBOL, WITHIN AN EQUILATERAL TRIANGLE, IS INTENDED TO ALERT THE USER TO THE PRESENCE OF UNINSULATED " DANGEROUS VOLTAGE " WITHIN THE PRODUCT'S ENCLOSURE THAT MAY BE OF SUFFICIENT MAGNITUDE TO CONSTITUTE A RISK OF ELECTRIC SHOCK TO PERSONS.		
	THE EXCLAMATION POINT WITHIN AN EQUILATERAL TRIANGLE IS INTENDED TO ALERT THE USER TO THE PRESENCE OF IMPORTANT OPERATING AND MAINTENANCE (SERVICING) INSTRUCTIONS IN THE LITERATURE ACCOMPANYING THE APPLIANCE.		

REQUIREMENT BY NEDERLAND GAZETTE

Batteries are supplied with this product. When they empty, you should not throw away. Instead, hand them in as small chemical waste.

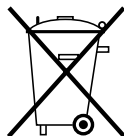

The marking of products using lasers (Except for some areas)



The marking is located on the rear panel and says that the component uses laser beams that have been classified as Class 1. It means that the unit is utilizing laser beams that are of a weaker class. There is no danger of hazardous radiation outside the unit.

Special features

CD player with 200-disc changer

This unit can accommodate up to 200 discs and can be used like a home jukebox.

CD-TEXT support

The text information (disc title, track titles, names of the artists, songwriters, composers, etc.) recorded on the CDs can be easily called and displayed in alphanumeric. (Some Japanese words and text may not be displayed.) → 15

Title name registrable

In case of a disc not corresponding to CD-TEXT, you can register a disc title or other information yourself. → 20

Programmed playback

Desired tracks from up to 200 discs can be selected and programmed in the desired order. (Maximum 32 tracks) → 16

Filing functions suitable for a 200-disc changer

An enhanced filing function is provided to handle the large disc capacity.

Music type: Discs are filed by 26 music genres. → 24
 Best selection: Only favorite tracks can be registered from 200 discs and played. → 27

Contents

Introduction	2	Repeated playback (REPEAT mode)	18
⚠ Before applying power	2	To repeat only the desired tracks	18
⚠ Safety precautions	2	To repeat one selected disc	18
Special features	3	Playback in a random order (RANDOM mode)	19
System connections	6	To select another track in the middle of playing one	19
Connection to digital amplifier or MD	7	To cancel random playback	19
Connection to a general-use amplifier	7	Registration of Title Name	20
Controls and indicators	8	Assigning Title Names	20
Operation of remote control unit	9	To change the character type	21
Loading batteries	9	To change or delete a title name	22
Operation	9	To switch between insert and overwrite mode	23
Preparation	10	To enter a space	23
Loading discs in the carousel	10	Listening to music by genre (MUSIC TYPE mode)	24
In regard to ALL DATA READ mode	11	Registration of music type files	24
Normal play (TRACK mode)	12	To delete the registered music type	25
Playing tracks in order from track No.1	12	Playing the music type file	26
Direct disc selection	13	Listening to your favorite titles	
Playback from desired track	14	(BEST SELECTION mode)	27
Skipping tracks	14	Registration of best selection file	27
Searching	14	Playing the best selection file	28
Displays	15	To delete the registered best selection	28
Programming tracks in desired order (PGM mode)	16	Timer operation	29
To check the programmed tracks	17	Important items	30
To add a track to the program	17	In case of difficulty	31
To change a track in the program	17	Specifications	32
To clear tracks from the program	17		

4

Unpacking

Unpack the unit carefully and make sure that all accessories are put aside so they will not be lost.

Examine the unit for any possibility of shipping damage. If your unit is damaged or fails to operate, notify your dealer immediately. If your unit was shipped to you directly, notify the shipping company without delay. Only the consignee (the person or company receiving the unit) can file a claim against the carrier for shipping damage.

We recommend that you retain the original carton and packing materials for use should you transport or ship the unit in the future.

Keep this manual handy for future reference.

Accessories

Audio cord (1)

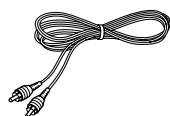

System control cord (1)

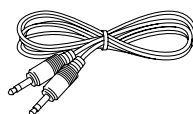

Remote control unit (1)

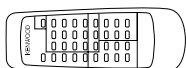

Batteries (R6/AA) (2)



Types of discs playable on this unit

- With CD-G (CD Graphics) discs, this unit can play only the audio part.
- An 8 cm CD cannot be played back.

Disc Type	Disc Size
CD (ordinary Compact Disc)	12 cm
Audio part of CDV (CD with video)	12 cm

Disc handling precautions

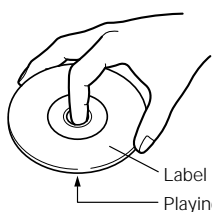

Handling

Hold compact discs so that you do not touch the playing surface.

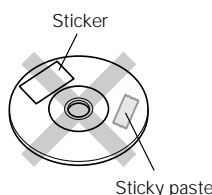

- Do not attach paper or tape to either the playing side or the label side of compact discs.
- The paste left on the label surface after a sticker has been peeled off is a factor which may cause malfunction. If the surface is sticky due to remaining paste, be sure to clean it with alcohol before use.

Cleaning

If fingerprints or foreign matter become attached to the disc, lightly wipe the disc with a soft cotton cloth (or similar) from the center of the disc outwards in a radial manner.

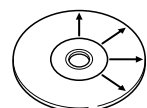

Storage

When a disc is not to be played for a long period of time, remove it from the CD player and store it in its case.

Never play a cracked or warped disc

During playback, the disc rotates at high speed in the player. Therefore, to avoid danger, never use a cracked or deformed disc or a disc repaired with tape or adhesive agent. Please do not use discs which are not round because they may cause a malfunction.

CD accessories

The CD accessories (stabilizer, protection sheet, protection ring, etc.) which are marketed for improving the sound quality or protecting discs as well as the disc cleaner should not be used with this system because they may cause malfunction.

System connections

CD-224M/DPF-J5010 (En)

6

Make connections as shown below.

When connecting the related system components, refer also to the instruction manuals of the related components. Do not plug in the power lead until all connections are completed.

Be sure to use this unit placed on a level surface.



Malfunction of microcomputer

If operation is not possible or erroneous display appears even though all connections have been made properly, reset the microcomputer referring to "In case of difficulty". → 31

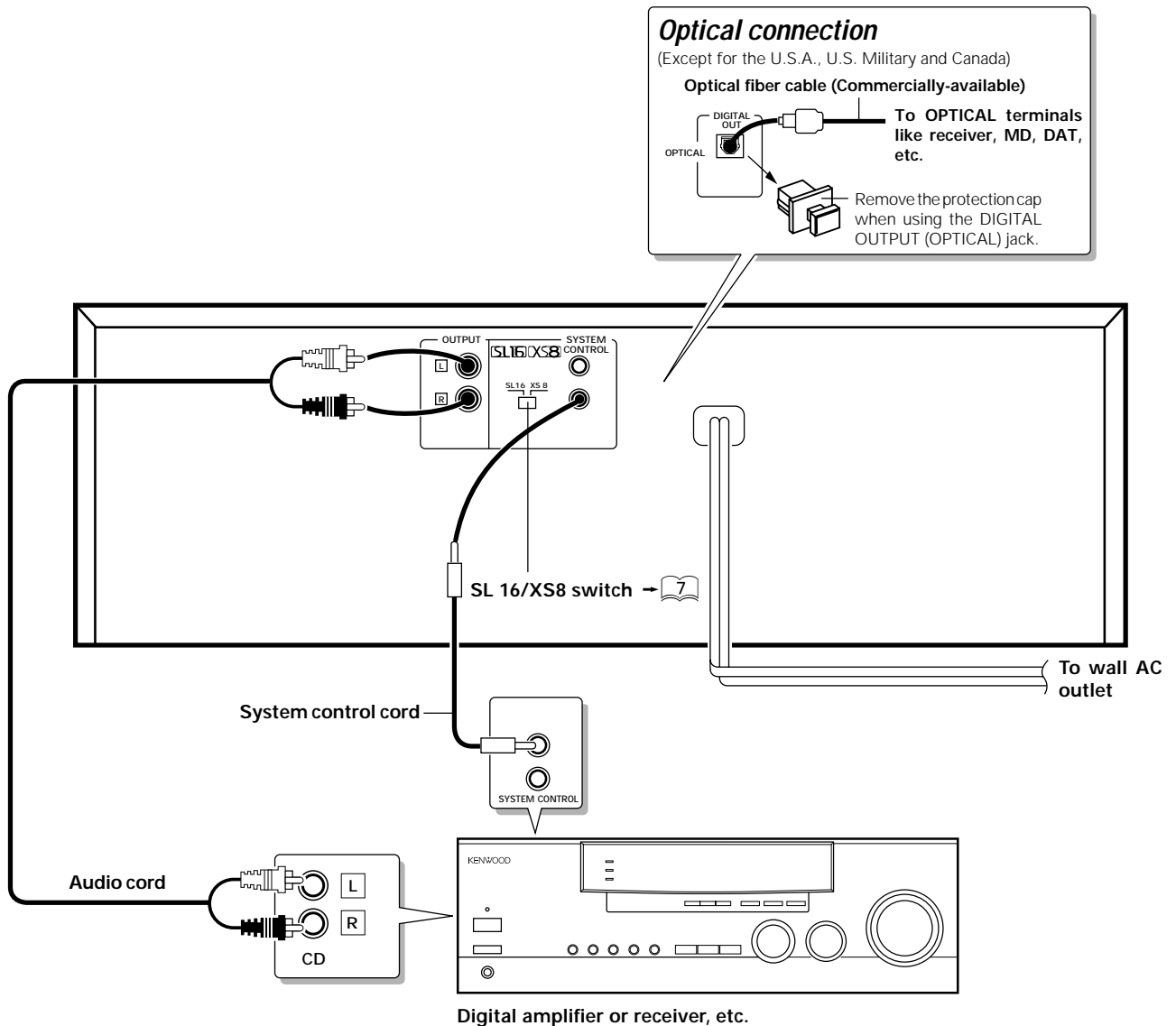

1. Connect all cords firmly. If connections are loose there could be loss of sound or noise produced.
2. When plugging and unplugging connection cords, be sure to first remove the power cord from the AC outlet. Plugging/unplugging connection cords without removal of the power cord can cause malfunctions or damage to the unit.

Connection to digital amplifier or MD

Connect the DIGITAL OUT (OPTICAL) jack to the digital input jack of the amplifier, DAT recorder, MD recorder, etc., using an optical fiber cable which are commercially available in audio stores.

- When using an optical fiber cable to connect this unit to a digital amplifier, insert the plug straight into the jack until a snap sound is heard.
- Be careful not to bend, coil, or bundle the optical fiber cable.
- Optical fiber cables available on the market may not always be able to be used with this player. If your cord cannot be used with this unit, consult the store from which you purchased the cord or your nearest dealer.

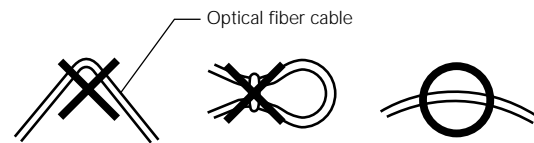

Connection to a general-use amplifier

Use the provided audio cords to connect the OUTPUT jacks of this unit to the CD input jacks (or AUX jacks) of the amplifier.

SYSTEM CONTROL CONNECTIONS

Connecting system control cords after connecting a KENWOOD audio component system lets you take advantage of convenient system control operations.

There are two KENWOOD system control modes. Make connections according to the groups of terminal symbols shown below.

[XS8] Mode : lets you combine [XR], [XS], and [XS8] terminals

[SL16] Mode : for [SL16] terminals only

This unit is compatible with both [XS8] and [SL16] modes.

Select the mode according to the connected components.

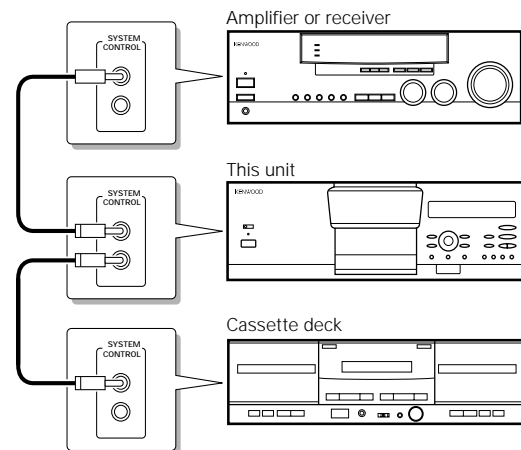
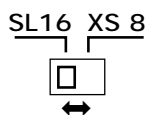

- Do this operation after completing all connections. (Ensure that the power plug is not connected.)



1. If your amplifier or receiver does not have a system control terminal, do not connect any system control cords to the system control terminals on the other components.
2. Do not connect system control cords to any components other than those specified by KENWOOD. It may cause a malfunction and damage your equipment.
3. Be sure the system control plugs are inserted all the way in to the system control terminals.

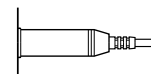

SYSTEM CONTROL OPERATIONS

Remote Control

Lets you operate this unit with the system remote control unit supplied with the amplifier or receiver.

Automatic Operation (Except [XR] equipment)

Automatically switches the input selector on the amplifier or receiver when you start playback from this unit.

Synchronized Recording (Except [XR] equipment)

Lets you synchronize recording with the start of playback when recording from a CD. Also, the simple CCRS operation enables great recordings from CDs.

See the operating instructions supplied with your cassette deck for details.

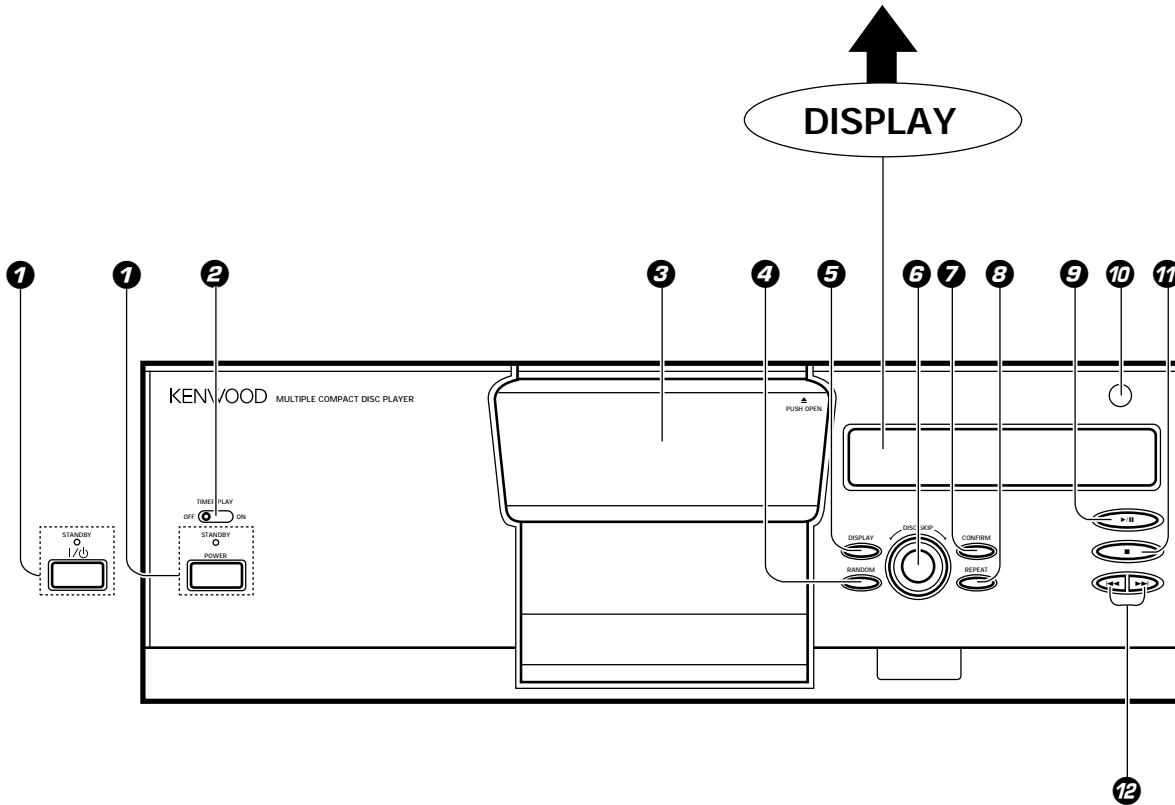
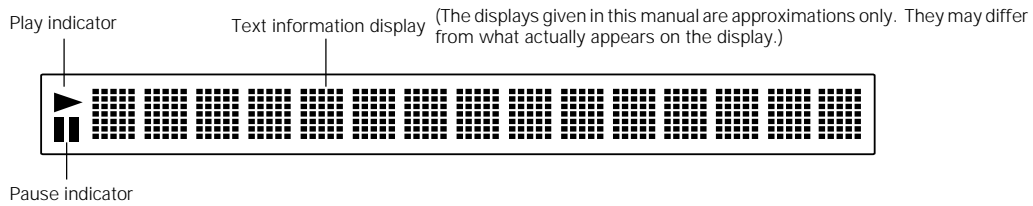

1 POWER key/STANDBY indicator (For the U.S.A. and Canada)
I / ⏻ key/STANDBY indicator (For other countries)

2 TIMER PLAY switch
 Used for timer play ON/OFF.

3 Door panel

4 RANDOM key
 Press to start random playback.

5 DISPLAY key
 Switching between title display and time display.

6 DISC SKIP knob
 Used for disc selection. Characters are selected at the time of title registration.

7 CONFIRM key
 The present playback mode is displayed.

8 REPEAT key
 Press to start repeated playback.

9 Play/Pause key (▶/⏸)

10 Remote sensor

11 Stop key (■)

12 Skip keys (◀◀▶▶)
 Press to skip to the beginning of another track.
 Characters are selected at the time of title registration.

About the STANDBY mode

While the STANDBY indicator is lit, a small amount of power is supplied to the system to back up the memory. This is called the standby mode. Under that condition, the system can be turned ON by the remote control unit.

Operation of remote control unit

CD-224M/DPF-J5010 (En)

The keys with the same name as those on the main unit operate the same way as on the main unit. The keys marked * are provided only on the remote control unit.

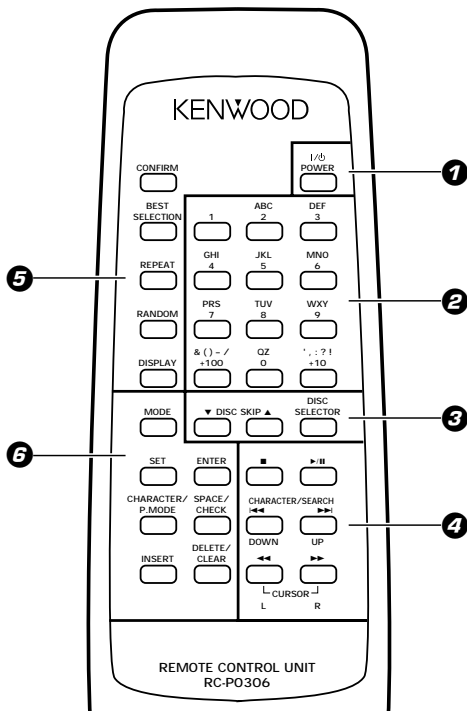

Model: RC-P0306
Infrared ray system

<p>1 POWER key</p> <p>2 Input keys for numbers and letters * Used for selection of disc numbers and track numbers, as well as for title name registration.</p>	<p>5 Keys related to program and file registration</p> <p>* MODE key Used for music type file and title name registration and playback.</p> <p>* SET key Used for confirmation of mode settings. At the time of title name registration, one character is confirmed and the cursor goes to the next digit.</p> <p>* ENTER key Used for title name confirmation.</p> <p>* CHARACTER/P.MODE key Used for playback mode switching. At the time of title name registration, this key switches between capital letters/small letters/numbers and special characters.</p> <p>* SPACE/CHECK key Used to confirm the entered contents. Inserts a space at the time of title name registration.</p> <p>* INSERT key Switches between insert and overwrite mode at the time of title name registration.</p> <p>* DELETE/CLEAR key Used to delete the entered contents. At the time of title name registration, characters are deleted.</p>
<p>3 Disc selection keys DISC SKIP keys (▼, ▲) * DISC SELECTOR key Press to select a disc number.</p>	
<p>4 Keys for basic operation and character input Stop key (■) Play/pause key (▶/⏸) CHARACTER/SEARCH; Skip (DOWN/UP) keys (◀◀, ▶▶) * Search; CURSOR (L/R) keys (◀, ▶) Press to move the played position of disc at high speed. Used as cursor keys at the time of title name registration.</p>	
<p>5 Keys related to playback mode and display CONFIRM key * BEST SELECTION key Used for best selection registration and playback.</p> <p>REPEAT key RANDOM key DISPLAY key</p>	

Loading batteries

1 Remove the cover.

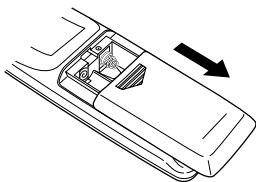

2 Insert batteries.

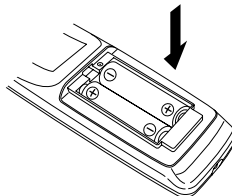

3 Close the cover.

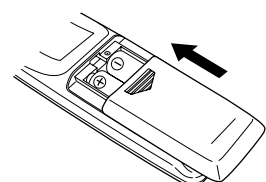

● Insert two AA-size (R6) batteries as indicated by the polarity marking.

Operation

After plugging in the power cord, press the **POWER (I / ⏻)** key of the main unit to turn the power ON. When the power is turned ON, press the key of the function to be operated.

● When pressing more than one remote control key successively, press the keys securely by leaving an interval of 1 second or more between keys.

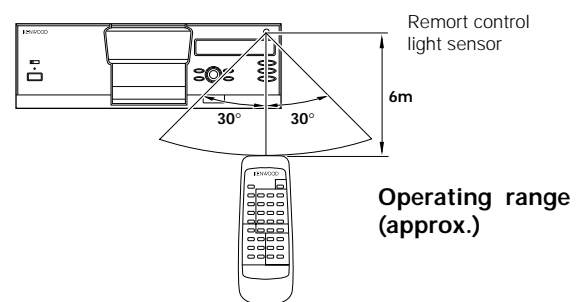

1. The supplied batteries are intended for use in operation checks. Therefore, their lives may be shorter than ordinary batteries.
2. When the remote-controllable distance gets shorter than before, replace both batteries with new ones.
3. Malfunction may occur if direct sunlight or the light of a high-frequency lighting fluorescent lamp enters the remote control light sensor. In such a case, change the system installation position to prevent the malfunction.

Preparation

CD-224M/DPF-J5010 (En)

10

Up to 200 CDs can be loaded in the carousel. Disc exchange also is possible during playback.

Never let your hand or any object enter inside the unit.

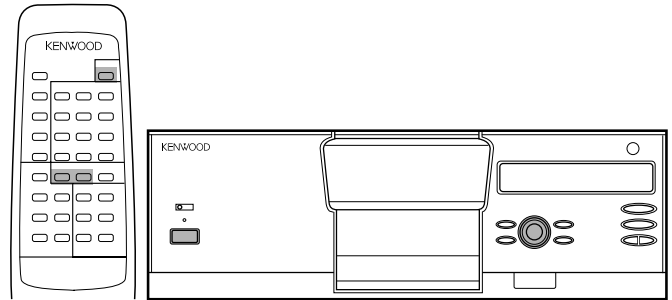

: Keys and controls used in the operations described on this page.

Loading discs in the carousel

1 Switch power ON.

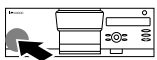

Press the POWER (I / ⏻) key.

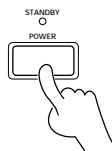

2 Open the door panel toward the front.

Press PUSH OPEN at the right top of the door panel.

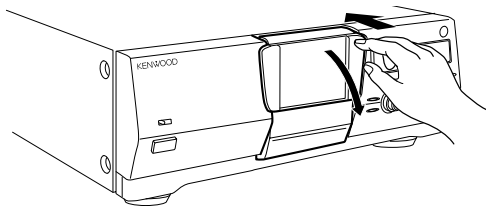

3 Load discs.



1 Turn the DISC SKIP knob and bring the slot with the disc to be placed to the front.

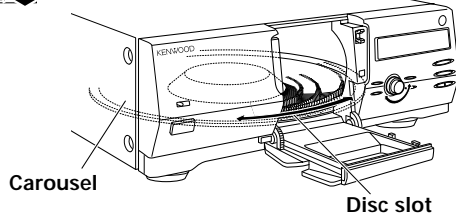

Carousel

Disc slot

2 Insert the disc vertically.

Insert CDs with the label side facing toward your right.

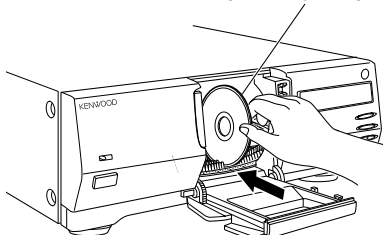

Insert one CD per slot all the way.

3 Repeat 1 and 2 to insert discs.

- Do not place any object on the open door panel.

DISC001

The slot No. is displayed when the DISC SKIP knob is turned.



Insert discs with the label on the right side. Playback is not possible when a disc is inserted the other way round.

- Do not insert more than one disc in a slot.



When a disc not corresponding to CD-TEXT is inserted, searching for this disc will be facilitated when the title name is registered at the time of disc insertion.
"Registration of Title Name"

Disc replacement

Discs can be replaced with the same procedure as "Loading discs in the carousel". In stopped condition, all discs can be exchanged. However, when the door panel is opened while "DISC DETECTION" is being displayed, it may not be possible to remove the disc which had been played. Accordingly, wait for the "DISC DETECTION" indication to go out before opening the door panel. When the disc information has been read in at the time of registration of disc information like title name, music type, etc., the disc information can be recalled even when the disc insertion place is changed.

→ 20 → 24

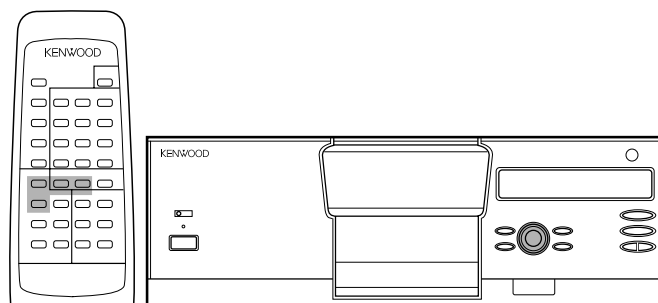

: Keys and controls used in the operations described on this page.

4 Close the door panel.

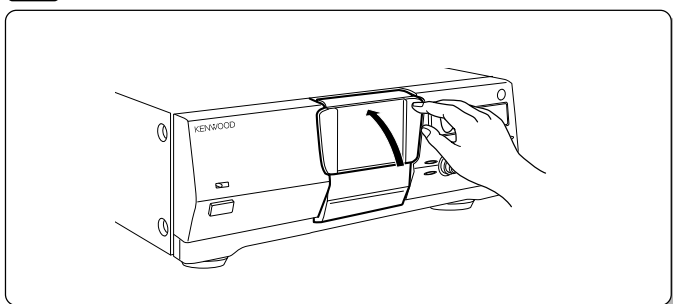

- When a title name has been registered and the door panel is closed, reading operation is performed automatically.

The display flashes.

DISC READING

In regard to ALL DATA READ mode

The disc information for all discs will be read. It is convenient to execute this mode before playback after discs have been exchanged. Close the door panel before operation.

1 Press the MODE key.

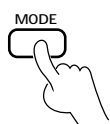

2 Select "ALL DATA READ".

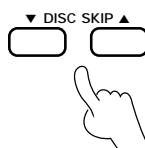

3 Set the input.

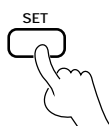

Each press switches the modes as follows:

- 1 MUSIC TYPE
- 2 TITLE INPUT
- 3 ALL DATA READ
- 4 ALL INFORMATION

ALL DATA READ

Search in progress or reading information The display flashes.

DISC READING

When the disc is CD-TEXT

D001 : CD TEXT

- Repeat the above procedure so that the complete disc information is read into the CD player.
- In the case of a non-CD-TEXT disc, the "D001:NO CD TEXT" display will appear for approx. 3 seconds.

To quit ALL DATA READ mode

Press the ■ key.



- Please remove all CDs from the carousel before moving the unit.
- In case of blinking indication of "DISCXXX ERROR", open the door panel, confirm that the error disc has come to the center position, and then exchange the error disc.

Normal play (TRACK mode)

CD-224M/DPF-J5010 (En)

12

Preparation

- Load discs into the carousel.

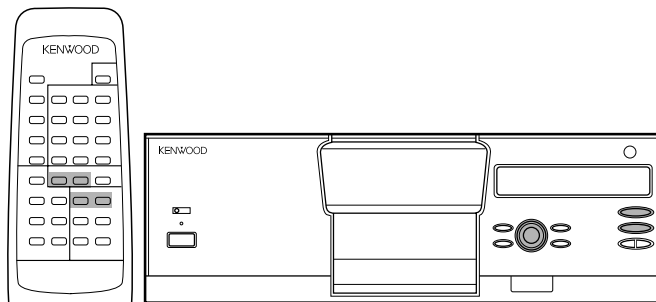

 : Keys and controls used in the operations described on this page.

Playing tracks in order from track No.1

Use the following procedure to play a CD in the original order of tracks from track No.1.

1 Select the disc.

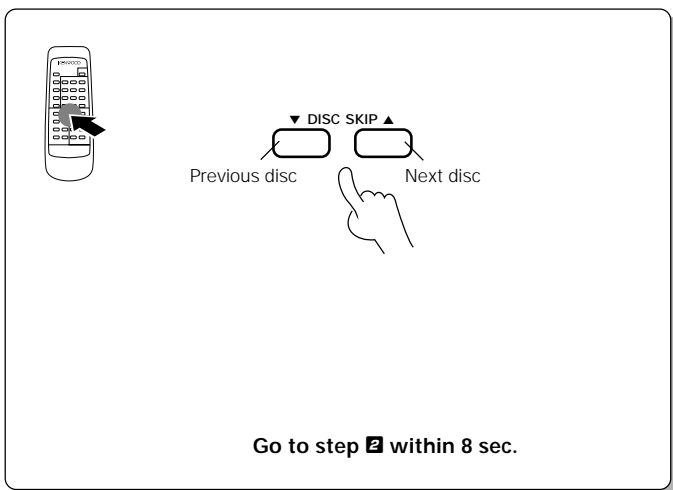

- Each press of a key increases (or decreases) the disc number. Holding the key depressed varies the disc numbers successively.
- When the disc corresponds to CD-TEXT, or when the disc title has been registered, the disc title will be displayed with scrolling. Discs can be selected while looking at the recorded contents.

"Registration of Title Name"



Display when disc No. 123 is selected

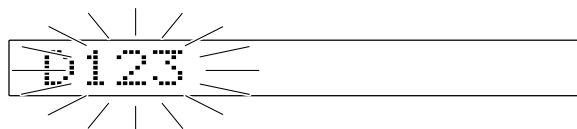

Lights up.



- In the case of a CD-TEXT disc, the track's title is scrolled on the display.

2 Start playback.

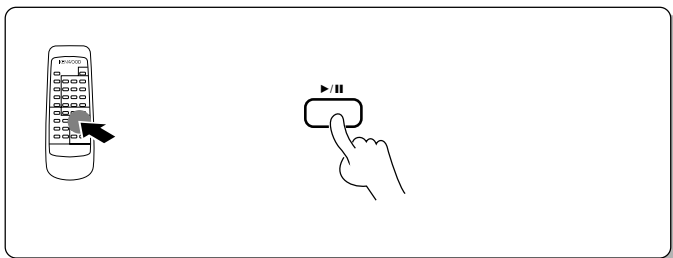

To pause playback

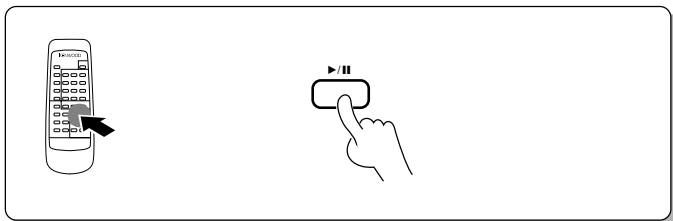

- Each press pauses and plays the CD alternately.

To stop playback

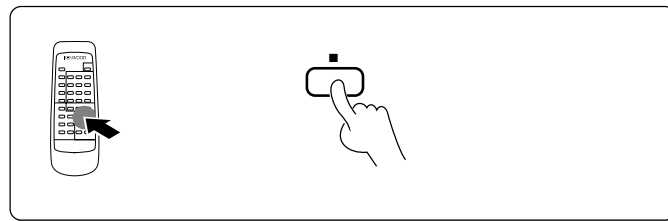

Direct disc selection

1 Press the DISC SELECTOR key.

DISC SELECTOR

Within 8 seconds!

2 Input the disc number.

1	ABC	DEF
2		
GHI	JKL	MNO
4	5	6
PRS	TUV	WXY
7	8	9
& () - /	OZ	': : ? !
+100	0	+10

Within 8 seconds!

3 Start playback.

Press the numeric keys in the following order...

Disc No. 63 : **6 3**
 Disc No. 100 : **1 0 0**

How to input numeric values

As this unit requires input of large numeric values, it adopts a different input method from other KENWOOD products. However, the method used with other KENWOOD products can also be used to input numeric values in this unit.

Special input method for CD player with 200-disc changer

To input 42 : **4 2**
 To input 115 : **1 1 5**
 To input 200 : **2 0 0**

Same input method as other KENWOOD products

To input 42 : **+10 +10 +10 +10 2**
 To input 115 : **+100 +10 5**
 To input 200 : **+100 +100**

What is the "normal play TRACK mode"?

Playback is made from the first track. The normal playback mode is called TRACK mode. Press the CONFIRM key to confirm the present mode.



TRACK mode

▶ TRACK D120 T02

PGM mode

▶ PGM01 D131 T02

BEST SELECTION mode

▶ BEST01 D104 T03

MUSIC TYPE mode

▶ M. TYPE Rhythm

RANDOM mode

▶ ONE DISC RANDOM

REPEAT mode

▶ REPEAT ON

To set the unit to the TRACK mode:

At the time of PGM mode : Press the P.MODE key.

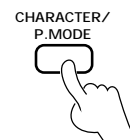

At the time of BEST SELECTION mode : Press the ■ key during playback.

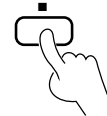

At the time of MUSIC TYPE mode : Press the MODE key.

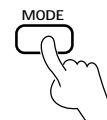

At the time of RANDOM mode : Select "RANDOM OFF".



Preparation

- Load discs into the carousel.

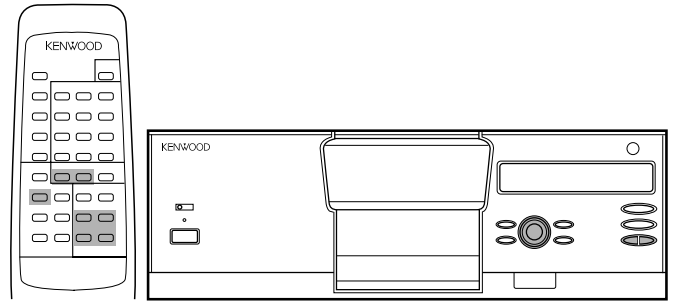

: Keys and controls used in the operations described on this page.

Playback from desired track

1 Select the disc.

1 Select the disc number.

Previous disc Next disc

▼ DISC SKIP ▲

Within 8 seconds!

2 Set the input.

SET

Go to step 2 within 8 sec.

Display when disc No. 123 is selected

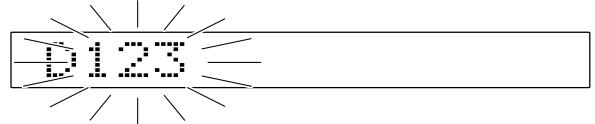

- The disc number can be selected directly by using the **DISC SELECTOR** and numeric keys in place of the **DISC SKIP** keys.
- When the disc corresponds to CD-TEXT, or when the disc title has been registered, the disc title will be displayed with scrolling. Discs can be selected while looking at the recorded contents.
- **Registration of Title Name** → 20
- Repeat step 1 when it is required to change the disc number.

2 Select the track number.

1 Input the track number.

1 2 3
4 5 6
7 8 9
0 * #

Within 8 seconds!

2 Set the input.

SET

Press the numeric keys in the following order...

- Track No.8 : 8
- Track No.14 : 1 4
- Track No.20 : 2 0

Display when track No. 8 is selected

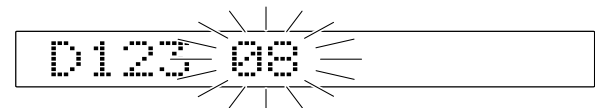

- Playback starts.
- In the case of a CD-TEXT disc, the track's title is scrolled on the display.
- Repeat step 2 when it is required to change the track number. When the disc corresponds to CD-TEXT, track numbers can be selected while looking at the track titles.

Skipping tracks

CHARACTER/SEARCH

To skip backward To skip forward

DOWN UP

- When the ◀◀ key is pressed once during playback, the track being played will be played from the beginning.

Searching

Backward search Forward search

L CURSOR R

- Playback starts from the position where the key is released.

Displays scrolling

Some track titles contain so much text information that the full titles will not fit on the display. In cases like this, the letters on the display move from right to left so that the non-visible part of the title is revealed. This type of display movement is known as "scrolling display."

Display example

← Scroll display

D123 GOOD OLD FASHIONED...
D123 FASHIONED

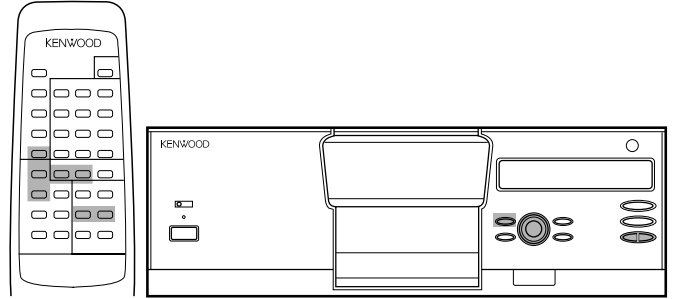

 : Keys and controls used in the operations described on this page.

Time display

Each press of the DISPLAY key changes the displayed contents.

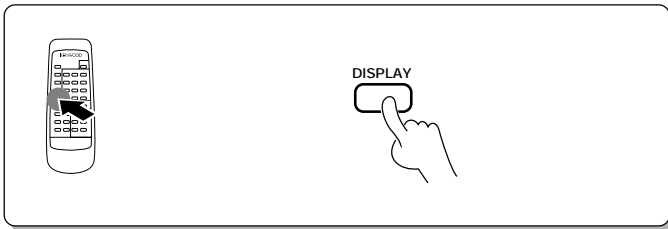

- ① ▶SAIL AWAY SWEET Track title display (only CD-TEXT)
- ② ▶DISC123 TRACK10 DISC NO., TRACK NO. display
- ③ ▶D123 10 1:23 Elapsed time of track being played
- ④ ▶D123 10 -2:37 Remaining time of track being played
- ⑤ ▶D123 10 23:45T Elapsed time of entire disc (T lights up.)
- ⑥ ▶D123 10 -36:25T Remaining time on entire disc (T lights up.)

- The displays ①, ②, ③, and ④ are shown in PGM mode, RANDOM mode, MUSIC TYPE mode, and BEST SELECTION mode.
- The displays ①, ② and ③ are shown in stop mode.

Displaying all the text information

In the case of a CD-TEXT disc, the text information shown below is displayed automatically during normal play (TRACK mode).

① Press the MODE key.

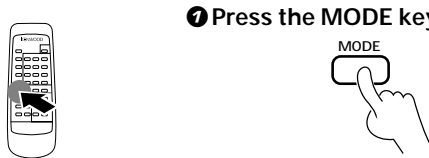

② Select "ALL INFORMATION".



③ Set the input.

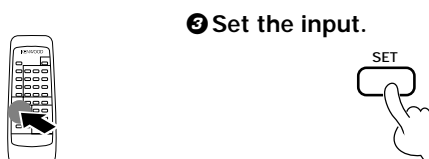

To jump to the next track or to return to the previous track during display:

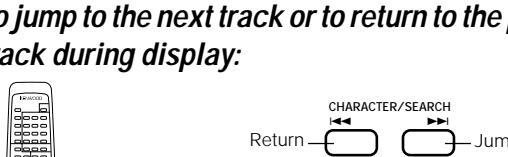

To jump to the next item or to return to the previous item during display:

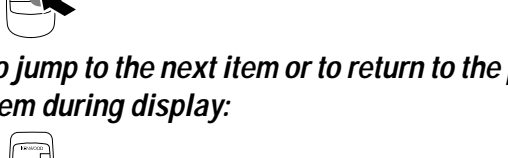

The display flashes.

ALL INFORMATION

- ① **Disc/Track Title** : Disc and track titles
- ② **Disc/Track Artist** : Singer (or performer)
- ③ **Disc/Track Songwriter** : Songwriter
- ④ **Disc/Track Composer** : Composer
- ⑤ **Disc/Track Arranger** : Arranger
- ⑥ **Disc/Track Message** : Message from sponsor or artist
- ⑦ **ID INFO.** : Record company, release date, etc.
- ⑧ **Genre INFO.** : Genre information

- Items from ① to ⑥ are displayed in the sequence of disc and track.
- When there is no text information to be displayed "-----" is scrolled on the display.
- In the case of a non-CD-TEXT disc, the "NO CD TEXT" display will appear for approx. 3 seconds.

To end ALL INFORMATION during display
Press the MODE key.

Programming tracks in desired order (PGM mode)

Use the following procedure to select desired tracks (up to 32 tracks) from up to 200 discs and program them in the desired order.

Preparation

- Load discs into the carousel.
- Set the CD player to stop mode.

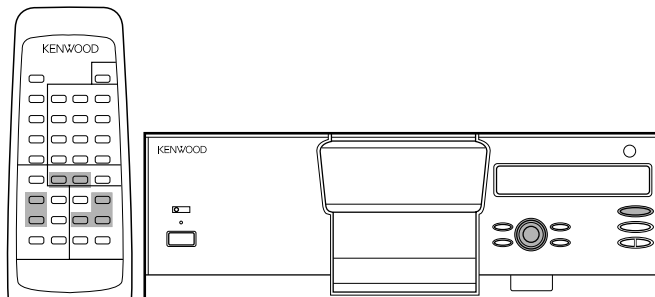

: Keys and controls used in the operations described on this page.

1 Press so that the PGM indicator lights.

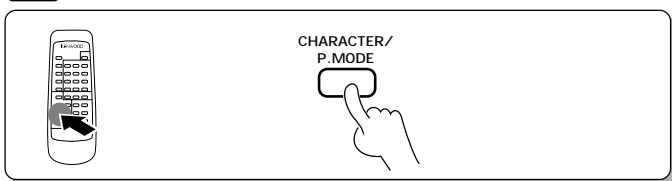

2 Select the disc.

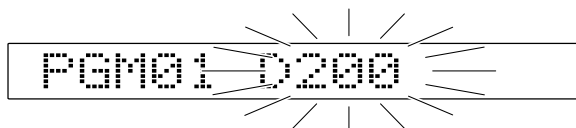
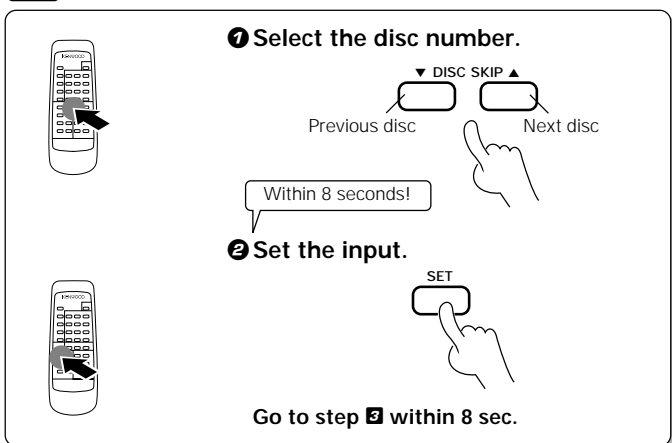

- The disc number can be selected directly by using the **DISC SELECTOR** and numeric keys in place of the **DISC SKIP** keys.
- When the disc corresponds to CD-TEXT, or when the disc title has been registered, the disc title will be displayed with scrolling. Discs can be selected while looking at the recorded contents.

"Registration of Title Name"



- If you make a mistake, press the **CLEAR** key and enter the disc No. from the beginning.
- Disc numbers which do not contain discs can be selected, but they are canceled at the time of playback.

3 Select the track number.

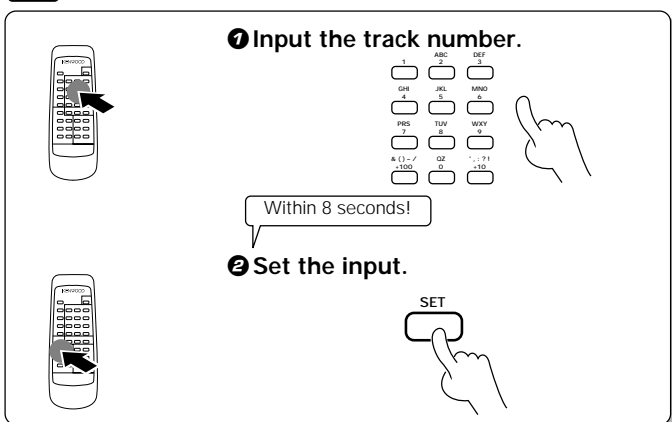

Press the numeric keys in the following order...

- Track No.8 : 8
- Track No.14 : 1 4
- Track No.20 : 2 0





- To program the entire disc, press the **SET** key without inputting the track number. "ALL" will be displayed.
- Program other tracks in the desired order by repeating steps 2 and 3.
- Up to 32 tracks can be programmed. "FULL" is displayed when no more tracks can be programmed.
- If you make a mistake, press the **CLEAR** key and restart from step 2.

4 Start playback.

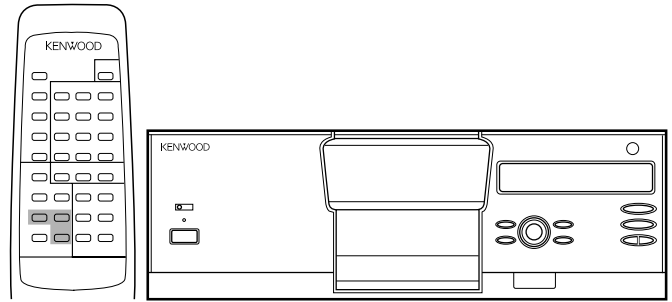

- Tracks will be played in the order they were programmed (in order of P Nos.).
- When the **◀◀** or **▶▶** key is pressed during playback, the track will be skipped in the direction of the pressed button.



 : Keys and controls used in the operations described on this page.

To check the programmed tracks

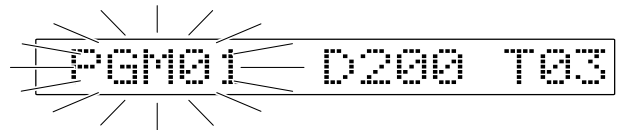
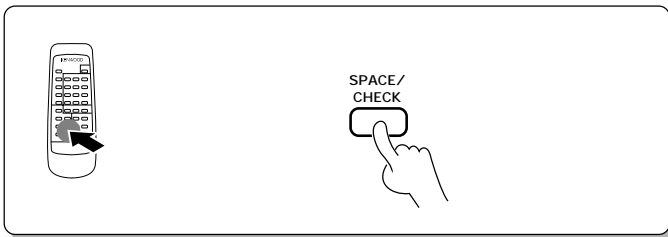

- Each time the key is pressed, the program No. (P-NO) and the disc No. are displayed.
- The previous display resumes in a few seconds.

To add a track to the program

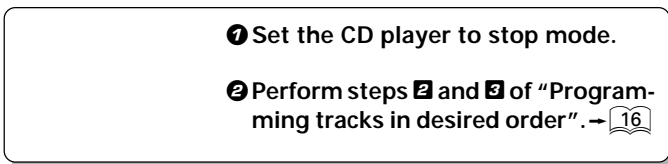

- 1 Set the CD player to stop mode.
- 2 Perform steps 2 and 3 of "Programming tracks in desired order". → 16

- When a track No. is entered, the track will be added to the end of the existing program.

To change a track in the program

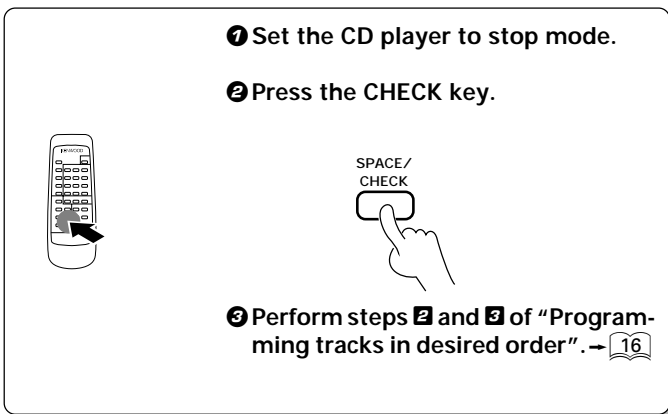

- 1 Set the CD player to stop mode.
- 2 Press the CHECK key.
- 3 Perform steps 2 and 3 of "Programming tracks in desired order". → 16

- Press the CHECK key repeatedly until the track No., to be changed is displayed.

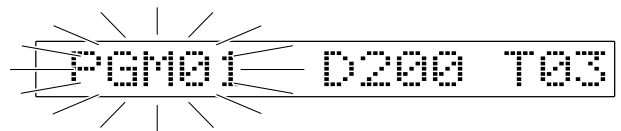

Example

- Press it while the "PGM01" indicator blinks.
- The track being played cannot be changed.

To clear tracks from the program

To clear tracks from the end

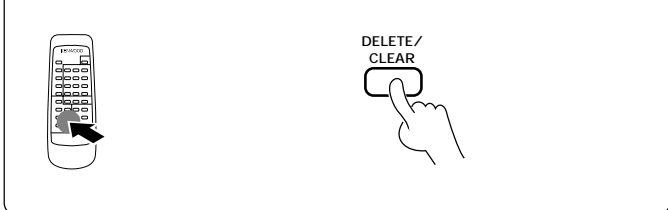

- Each time the key is pressed, the last track in the program is cleared.
- The tracks which are programmed earlier than the track being played cannot be cleared.

To clear all tracks

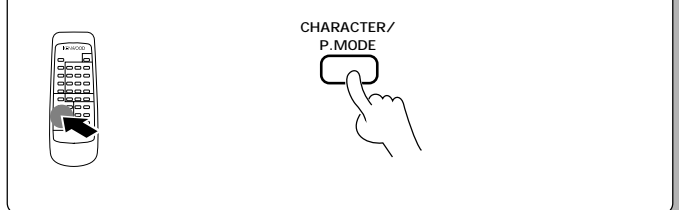

- When the P.MODE key is pressed during playback, playback in order of tracks starts from the track being played.

Repeated playback (REPEAT mode)

CD-224M/DPF-J5010 (En)

18

Preparation

- Load discs into the carousel. → 10

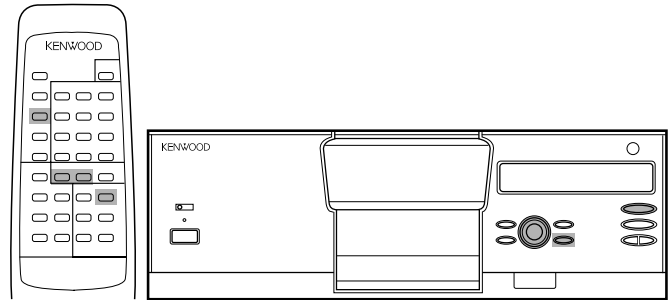

 : Keys and controls used in the operations described on this page.

To repeat only the desired tracks

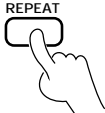
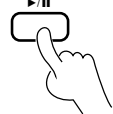
- 1 Program the desired tracks by performing steps 1 to 3 of "Programming tracks in desired order". → 16
- 2 Switch REPEAT ON.

- 3 Start playback.

- Up to 32 tracks can be programmed by repeating steps 1.

REPEAT ON



- The current status is displayed when the key is pressed once. When it is pressed while the status is displayed, the repeat ON status can be set to OFF (or vice versa).

- All of the programmed tracks will be repeated.
- In case only one track is programmed, only that track will be repeated.

To cancel repeated playback

Press the REPEAT key twice. (REPEAT ON → OFF)

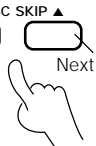
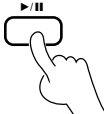
To repeat one selected disc

- 1 Check that the unit is in the normal play TRACK mode. → 13
- 2 Select the disc number.

Previous disc Next disc
Within 8 seconds!
- 3 Start playback.

- 4 Switch REPEAT ON.

- The disc number can be selected directly by using the DISC SELECTOR and numeric keys in place of the DISC SKIP keys.

REPEAT ON

- The current status is displayed when the key is pressed once. When it is pressed while the status is displayed, the repeat ON status can be set to OFF (or vice versa).

To cancel repeated playback

Press the REPEAT key twice. (REPEAT ON → OFF)

For random repetition

→ 19

For music type repetition

→ 26

For best selection repetition

→ 28

Playback in a random order (RANDOM mode)

Use the following procedure to activate random playback which selects a track at random after every track. This feature may allow you to play CDs for long hours without getting tired of.

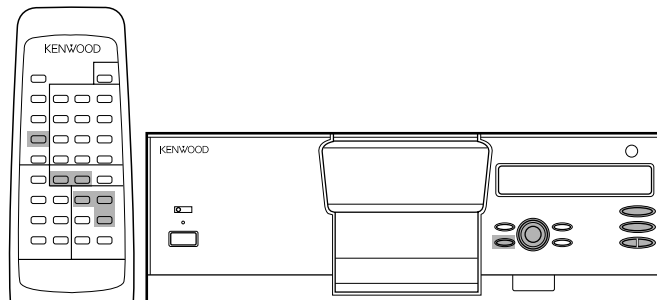

Keys and controls used in the operations described on this page.

Preparation

- Load discs into the carousel.



1 Check that the unit is in the normal play TRACK mode.

2 Select discs.

To select one disc

1 Select the disc number.

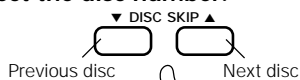

Within 8 seconds!

2 Start playback.

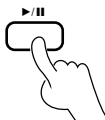

3 Select "ONE DISC RANDOM".



- The disc number can be selected directly by using the **DISC SELECTOR** and numeric keys in place of the **DISC SKIP** keys.

Each press switches the modes as follows:

- 1 ONE DISC RANDOM
- 2 ALL DISC RANDOM
- 3 RANDOM OFF



The number here changes.

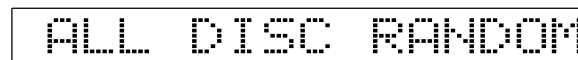

- Each time a track ends, the same operation as above is repeated, and the track selected next is played.
- Random play stops after all of the tunes have been played once.
- The random playback can also be repeated by pressing the **REPEAT** key.

To select all discs

Select "ALL DISC RANDOM".



To select another track in the middle of playing one

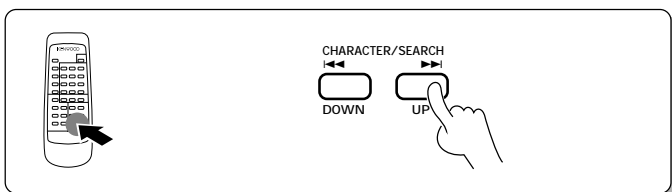

- Pressing the **CHARACTER/SEARCH** key once returns to the beginning of the track being played.

To cancel random playback

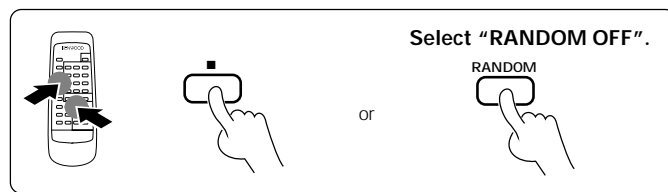

- Press the **STOP** key to stop playback.
- Normal playback will be performed when **RANDOM OFF** is selected.

Registration of Title Name

CD-224M/DPF-J5010 (En)

20

For discs not corresponding to CD-TEXT, a title name can be given to the disc (max. 25 characters). Operation is possible also when the door panel is open. It is convenient to register titles while discs are being inserted.

Preparation

- Load discs into the carousel. → 10
- Set the CD player to stop mode.
- Check that the unit is in the normal play TRACK mode. → 13

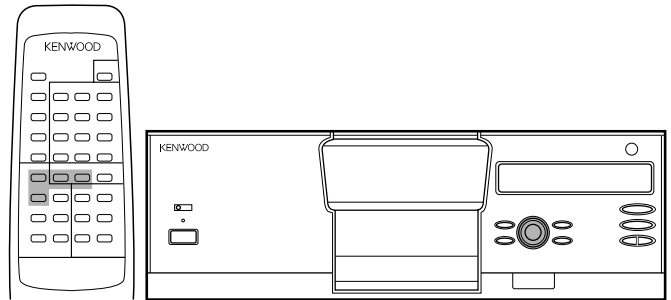

■ : Keys and controls used in the operations described on this page.

Assigning Title Names

1 Switch to title name input mode.

1 Press the MODE key.

2 Select "TITLE INPUT".

3 Set the input.

- When the **MODE** key is pressed during title name input mode, the input mode is cancelled.

The display flashes.

TITLE INPUT

D SELECT

2 Select the desired disc.

1 Select the disc number.

2 Set the input.

- The disc number can be selected directly by using the numeric keys in place of the **DISC SKIP** keys.
- During playback, the disc only being played can be selected.



1. For discs corresponding to CD-TEXT, a new title name can not be registered.
2. As the entered title names and the CD-TEXT title information are memorized, the information may be displayed even when a disc has been removed.

In regard to disc information reading

The entered title name is read in to the disc with the following timing.

- When the door panel is closed.
 - With closed door panel, when title name mode is cancelled.
- The display flashes.



When there are discs for which the disc information already has been read in, there may be no display.

Do not move or exchange discs until the disc information has been read in.

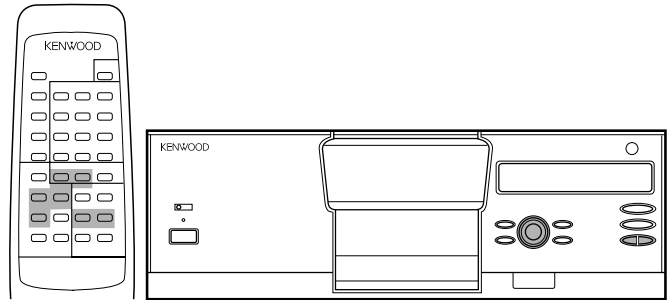

 : Keys and controls used in the operations described on this page.

3 Enter the disc title.

① Select a character.

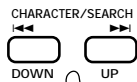

Press until the character to be entered comes to the position of the flashing cursor.

② Press the SET key.

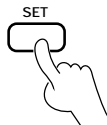

- The characters also can be selected with the **DISC SKIP** knob on the main unit. Turn the knob until the character to be entered comes to the position of the flashing cursor.

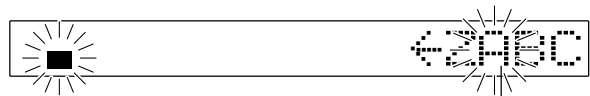

Flashing cursor

For direct selection of characters

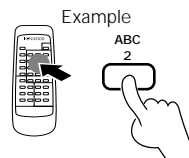

Each press switches the modes as follows:

- When capital letters have been selected : A→B→C→A
- When small letters have been selected : a→b→c→a
- When numbers/symbols have been selected : 2

- When the **SET** key is pressed, one character is set and the cursor goes to the next digit.
- Repeat this to enter the disc name.
- One character is set and the cursor goes to the next digit.
- Input the entire disc name by repeating ① and ② for each character.

4 Store the disc title.

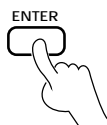

- To register the disc names of another disc, repeat the entire procedure from step ② for it.





To quit title name mode

Press the **MODE** key.

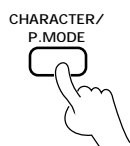
To change the character type

The type of characters which can be entered is switched each time the **CHARACTER** key is pressed.

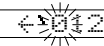

- ①   **Capital letters** : ABC.....XYZ.....
- ②   **Small letters** : abc.....xyz.....
- ③   **Numbers/symbols** : 0 1 2 3.....7 8 9
space ! " # \$ % & ' 0 * + , - . / : ; < = >
? @ ^ _ ` 0.....

Preparation

- Close the door panel.

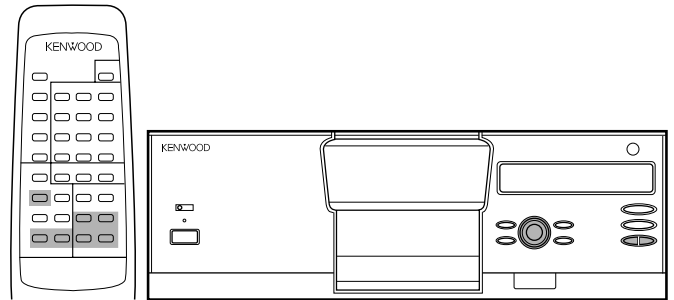

: Keys and controls used in the operations described on this page.

To change or delete a title name

1 Perform steps **1** and **2** of "Assigning Title Names".



2 Change or delete characters one by one.

Change

1 Select overwrite or insert mode.

→ 23

2 Move the cursor to the desired character (to be changed).

L CURSOR R

3 Select a character.

CHARACTER/SEARCH DOWN UP

Press until the character to be entered comes to the position of the flashing cursor.

4 Set the selected character.

SET

- Call the disc to be changed.
- Deletion mode is cancelled when the **MODE** key is pressed.



← Move with the ◀▶ keys →

- If the title to be changed is too long to be displayed on the display section, press the ◀ or ▶ key to scroll the display so that the characters hidden until then appear.



Flashing cursor

- The characters also can be selected with the **DISC SKIP** knob on the main unit. Turn the knob until the character to be entered comes to the position of the flashing cursor.

Deletion

1 Move the cursor to the desired character (to be deleted).

L CURSOR R

2 Press the DELETE key.

DELETE/CLEAR

- When a title name is to be deleted, delete all characters one by one.

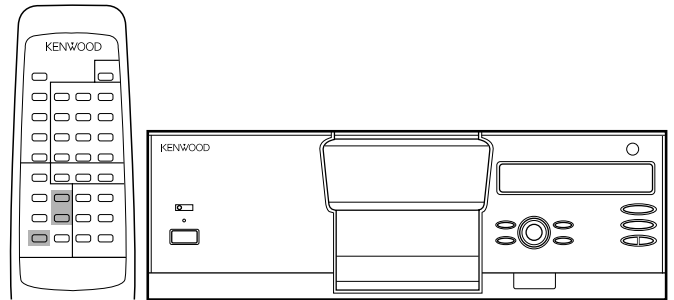

 : Keys and controls used in the operations described on this page.

3 Execute title change or deletion.

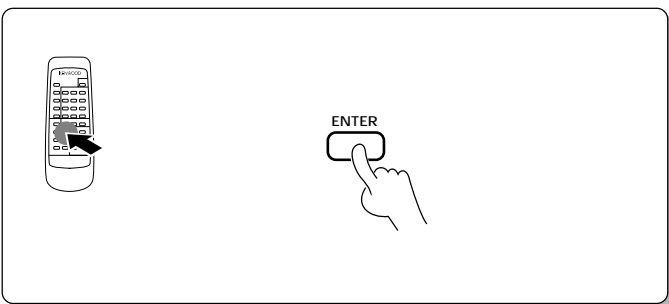

To quit title name mode

Press the MODE key.

To switch between insert and overwrite mode

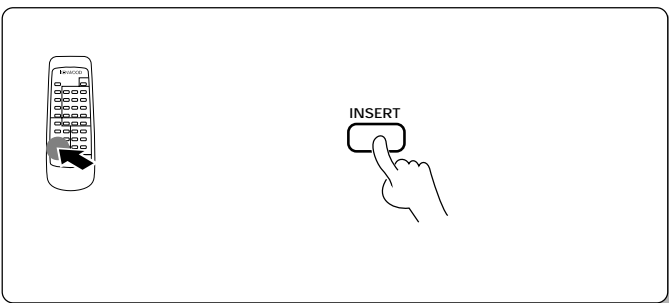

Each press switches the modes as follows:

- ① Insert mode : To insert characters before the cursor
- ② Overwrite mode : To replace characters

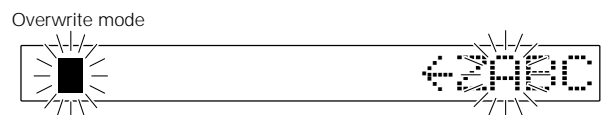
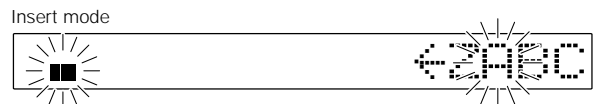

To enter a space

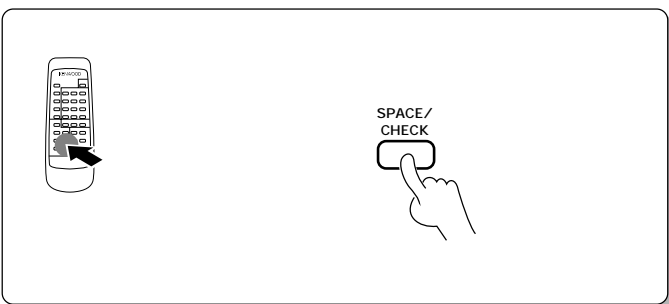

Listening to music by genre (MUSIC TYPE mode)

CD-224M/DPF-J5010 (En)

24

Discs can be registered separately by 26 types of music genres.

Preparation

- Load discs into the carousel. → 10
- Close the door panel. → 10
- Set the CD player to stop mode. → 13
- Check that the unit is in the normal play TRACK mode.

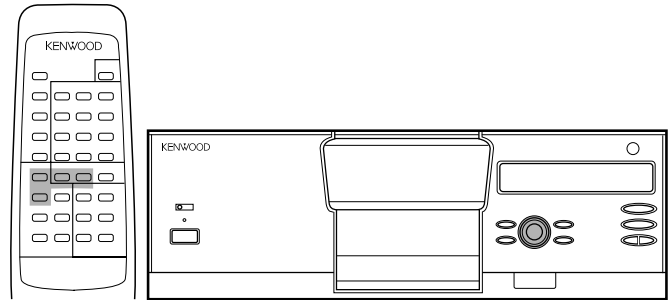

: Keys and controls used in the operations described on this page.

Registration of music type files

1 Activate the music type mode.

- 1 Press the **MODE** key.
- 2 Select "**MUSIC TYPE**".
- 3 Set the input.
- 4 Set to registration mode.

- When the **MODE** key is pressed during MUSIC TYPE mode, the MUSIC TYPE mode is cancelled.

Each press switches the modes as follows:

- 1 **MUSIC TYPE**
- 2 **TITLE INPUT**
- 3 **ALL DATA READ**
- 4 **ALL INFORMATION**

The display flashes.

MUSIC TYPE

The display flashes.

MUSIC TYPE SET

SELECT DISC

2 Select the desired disc.

- 1 Select the disc number.
- 2 Set the input.

- The disc number can be selected directly by using the numeric keys in place of the **DISC SKIP** keys.

In regard to disc information reading

The entered music type is read in to the disc with the following timing.

- When that disc is played.
- When ALL DATA READ is executed.



Do not move or exchange discs until the disc information has been read in.

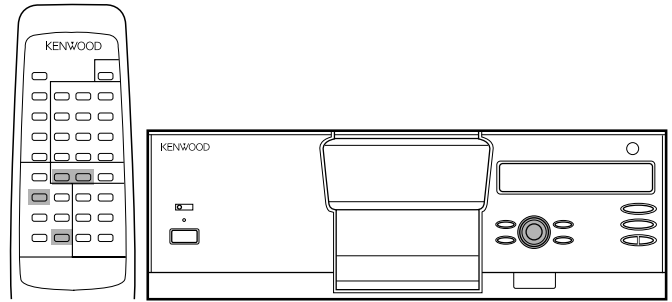

: Keys and controls used in the operations described on this page.

3 Select the music type.

1 Select the music type.

DISC SKIP

Previous file Next file

2 Set the input.

SET

Each press switches the modes as follows:

Adult Contemporary → Alternative Rock → Children's Music → Classical → Contemporary Christian → Country → Dance → Easy Listening → Folk → Gospel → Hip Hop → Jazz → Latin → Musical → New Age → Opera → Operetta → Pop Music → RAP → Reggae → Rock Music → Rhythm & Blues → Sound Effects → Sound Track → Spoken Word → World Music.....

When "Rock Music" is selected



- When the selected disc corresponds to CD-TEXT and contains a genre code, that genre code is registered as the music type.

To confirm the genre code ...

"Displaying all the text information"



- Repeat from step 2 to change the registered music type.
- To register another music type file, repeat the procedure from step 2.

To quit MUSIC TYPE mode

Press the MODE key.

To delete the registered music type

1 Play the music type file. → 26

2 Press the CLEAR key during playback of the disc to be deleted.

DELETE/CLEAR



When music types have been registered for the discs, it is possible to enjoy playback of discs of the selected music type. Random playback for a selected music type also is possible.

Preparation

- Load discs into the carousel. → 10
- Register music type files. → 24
- Check that the unit is in the normal play TRACK mode. → 13
- Set the CD player to stop mode.

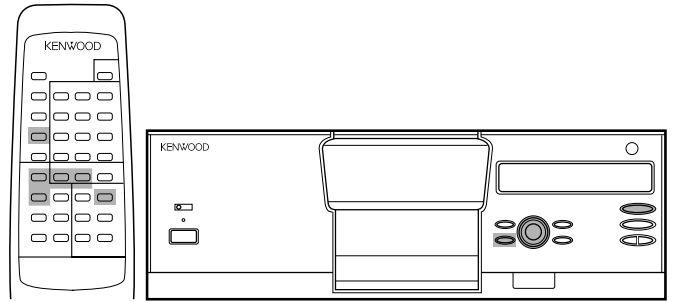

■ : Keys and controls used in the operations described on this page.

Playing the music type file

1 Activate the music type mode.

① Press the **MODE** key.

② Select "**MUSIC TYPE**".

③ Set the input.

- When the **MODE** key is pressed during MUSIC TYPE mode, the MUSIC TYPE mode is cancelled.

Each press switches the modes as follows:

- ① **MUSIC TYPE**
- ② **TITLE INPUT**
- ③ **ALL DATA READ**
- ④ **ALL INFORMATION**



2 Select the music type.

▼ DISC SKIP ▲

Previous file Next file

- Press repeatedly until the desired music type is displayed.

When "Rock Music" is selected



3 Start playback.

- Playback is performed in increasing order of the disc numbers they were registered for the respective music type. Skipping to the next disc is done when the ►| key is pressed.
- Each time the **CHECK** key is pressed, the registered disc numbers are displayed in increasing order of the disc numbers.
- When the **REPEAT** key is pressed, playback of the music type file will be repeated.

For random playback

Press the **RANDOM** key.

- Select "**RANDOM OFF**" to quit random playback.

To quit MUSIC TYPE mode

Press the **MODE** key.



Listening to your favorite titles (BEST SELECTION mode)

CD-224M/DPF-J5010 (En)

27

You can select only your favorite titles and register them as the best selection. Use the following procedure to register favorite tracks in the best selection file while playing a CD.

Preparation

- Load discs into the carousel.

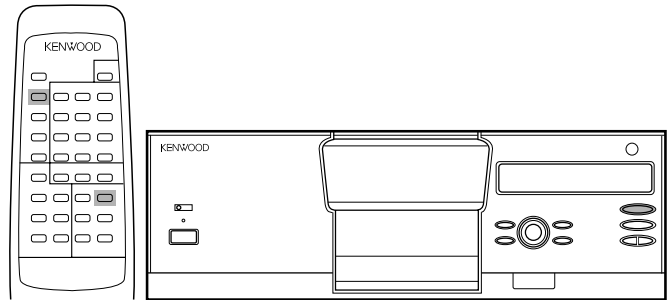

: Keys and controls used in the operations described on this page.

Registration of best selection file

1 Play the track to be registered.

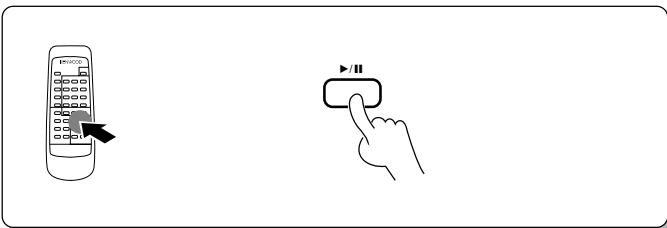

- Only the track being played can be registered.

2 Register it in the best selection file.

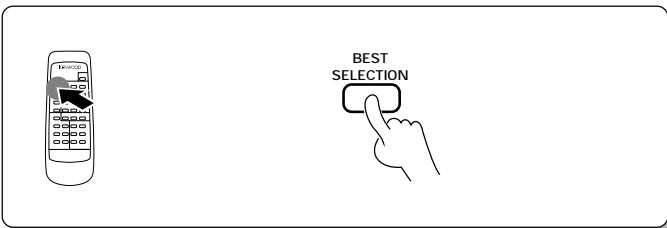

BEST01 D104 T03

3 Register other favorite tracks by performing steps 1 and 2 for each of them.

- Up to 32 tracks can be registered. "FULL" is displayed when no more disc is acceptable.

You can listen to only your favorite titles registered as the best selection.

Preparation

- Load discs into the carousel. → 10
- Register tracks in the best selection file. → 27
- Check that the unit is in the normal play TRACK mode. → 13
- Set the CD player to stop mode.

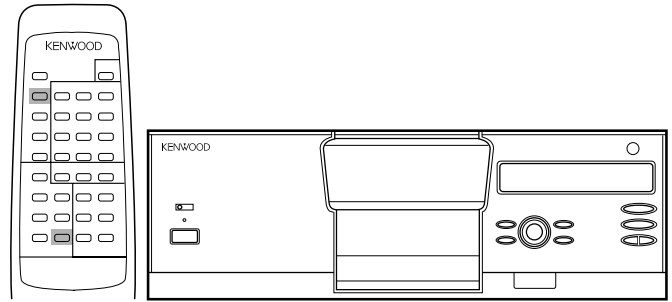

 : Keys and controls used in the operations described on this page.

Playing the best selection file

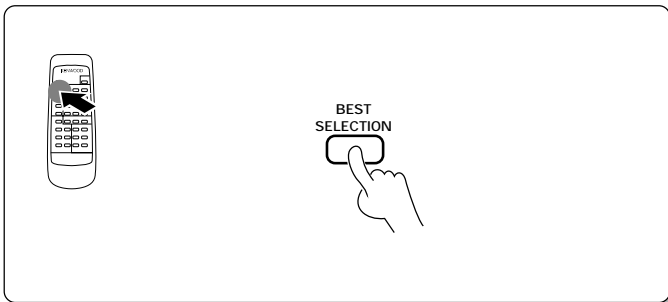

BEST SELECTION

- The tracks are played in the order they were registered.
- Each time the **CHECK** key is pressed, the disc numbers and track numbers are displayed in the order they were registered.
- When the **REPEAT** key is pressed, playback of the best selection file will be repeated.

To quit *BEST SELECTION mode*

Press the  key during playback.

- The recorded contents remain stored even when best selection mode is quit.

To delete the registered best selection

This is done during best selection mode.

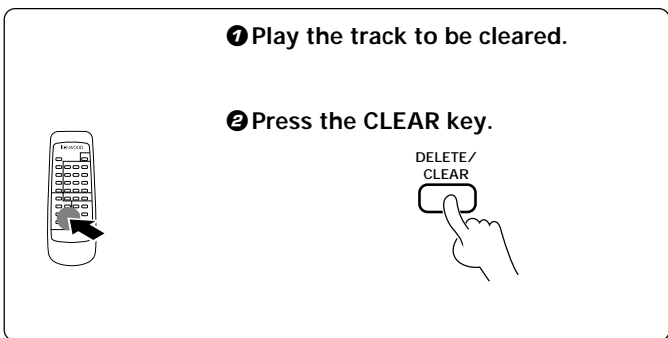

① Play the track to be cleared.

② Press the **CLEAR** key.

BEST02 CLEAR

Timer operation

As this unit incorporate the timer standby function, playback can be started at desired moment if a commercially available audio timer is combined with this unit.

Preparation

- Load discs into the carousel. → 10
- Close the door panel. → 10
- Connect the system components so that their power can be switched on by the timer.
- Read the instruction manual of the timer carefully.

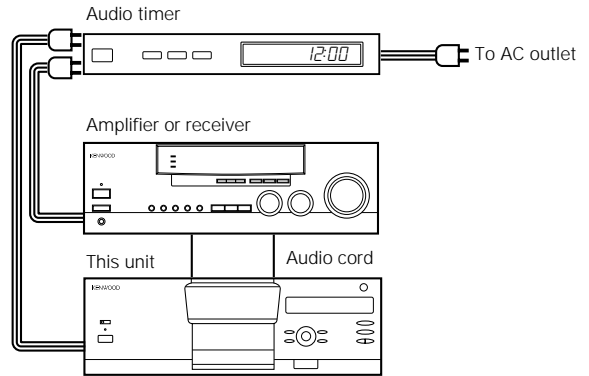

1 Set the power switches of the system components to the ON positions.

2 Select the disc to be played.

1 Select the disc number.

Previous disc Next disc

Within 8 seconds!

2 Play the disc.

- The disc number can be selected directly by using the **DISC SELECTOR** and numeric keys in place of the **DISC SKIP** keys.

3 Set the listening volume.

- Adjust the volume on the amplifier or receiver.
- Stop playback.

4 Set the timer for the desired ON time.

5 Set the **TIMER PLAY** switch to ON.

TIMER PLAY

OFF ON

- Read the instruction manual of the timer carefully.

- When the set time comes, playback will start automatically.

Cleaning

Do not use volatile solvents such as alcohol, paint thinner, gasoline, or benzine, etc. to clean the cabinet. Use a clean dry cloth.

Do not use contact cleaners because it could cause a malfunction. Be specially careful against contact cleaners containing oil, for they may deform the plastic components.

Periodic inspection

This unit incorporates an optical pickup which is a precision device. It is recommended to have this unit inspected periodically to clear the pickup after about 1000 hours of use, although this period may vary depending on the installation condition (temperature, humidity, dust, smoke, etc.) of the unit.

The unit has inspected, please consult your dealer or a KENWOOD service center in your area.

Caution on condensation

Condensation (of dew) may occur inside the unit when there is a great difference in temperature between this unit and the outside. This unit may not function properly if condensation occurs. In this case, leave the unit for a few hours with the power left ON, and restart the operation after the condensation has dried up.

Be specially cautious against condensation in a following circumstance:

When this unit is carried from a place to another across a large difference in temperature, when the humidity in the room where this unit is installed increases, etc.

Note related to transportation and movement

Before transporting or moving this unit, carry out the following operation:

1. Remove all discs from the carousel and close the door panel.
2. Confirm that the flashing "NO DISC" display has changed to steady lighting, and then switch off the power.



3. Wait a few seconds, then disconnect the power plug.

Memory backup function

Stored contents for at least 3 weeks after power plug is unplugged from the AC outlet.

Power status (ON or OFF),
Title name registration contents
Music type registration contents
Best selection registration contents

Operation to reset

The microcomputer may malfunction (impossibility to operate, erroneous display, etc.) when the connection cords are unplugged while power is ON or due to an external factor. In this case, execute the following method to reset the microcomputer and return it to normal condition.



Unplug the power cord from the power socket and plug the power cord into the socket again.

To reset the registered contents











The registered contents for title name, music type, and best selection can be reset by the following procedure.

Unplug the power cord from the power socket and, while holding the **■** key depressed, plug the power cord into the socket again.

Remote control unit

Symptom	Cause	Remedy
Remote control operation is not possible.	<ul style="list-style-type: none"> Batteries are exhausted. The remote control unit is too far away from the main system, controlling angle is too large, or there is an obstacle in between. 	<ul style="list-style-type: none"> Replace with new batteries. →  Operate the remote control unit within the controllable range. → 

CD Player

Symptom	Cause	Remedy
No power is applied with the POWER(I/⏻) key ON.	<ul style="list-style-type: none"> Power plug is loosely connected. With the power plug connected to the switched AC outlet of an amplifier, the power of the amplifier is turned off. 	<ul style="list-style-type: none"> Insert the power plug firmly to the AC outlet. Insert the power plug to the wall AC outlet.
Disc is loaded, player does not play.	<ul style="list-style-type: none"> Disc is loose. Disc is dirty. Disc is cracked. Condensation occurred on the optical lens unit. 	<ul style="list-style-type: none"> Insert disc properly. →  Wipe off the dust on the surface of the disc referring to "Disc handling precautions". →  Replace the disc with a new one. Leave the player for about 1 hour so that the condensation is removed. → 
No sound.	<ul style="list-style-type: none"> Disc is not loaded. Play mode is not entered (The play indicator is not lit). Disc is too dirty. Disc is cracked. The connection cords are inserted loosely. 	<ul style="list-style-type: none"> Load a disc and press the ▶/ key. →  Press the ▶/ key. Wipe off the dust on the disc surface referring to "Disc handling precautions". →  Replace the disc with a new one. Connect all connection cords firmly. → 
Music is interrupted. (Sound is skipped.)	<ul style="list-style-type: none"> Disc is too dirty. Disc is cracked. Oscillation is applied to this unit. 	<ul style="list-style-type: none"> Wipe off the dust on the disc surface referring to "Disc handling precautions". →  Replace the disc with a new one. Try selecting a place where no strong vibrations occur by changing the installation place, etc.
Scrolling display of "PLEASE CHANGE DISC OR PRESS PLAY" after flashing display of "DISCXXX ERROR"	<ul style="list-style-type: none"> A disc has been inserted into the carousel with the label on the left side. The disc is very scratched. 	<ul style="list-style-type: none"> Insert the disc with the label on the right side and press the ▶/ key. →  Exchange the disc and press the 6 key.
Disc selection is not possible.	<ul style="list-style-type: none"> MUSIC TYPE mode is selected. 	<ul style="list-style-type: none"> Press the MODE key to quit MUSIC TYPE mode. → 
Disc begins to play when power is switched ON.	<ul style="list-style-type: none"> The TIMER PLAY switch is set to ON. 	<ul style="list-style-type: none"> Set the TIMER PLAY switch to OFF unless timer playback is required. → 

Specifications

CD-224M/DPF-J5010 (En)

32

[Format]
System Compact disc digital audio system
Laser Semiconductor laser

[D/A Convertors]
D/A Conversion 1 Bit
Oversampling 8 fs (352.8 kHz)

[Audio]
Frequency response 4 Hz ~ 20 kHz, \pm 0.5 dB
Signal to noise ratio More than 98 dB
Dynamic range More than 96 dB
Total harmonic distortion + noise Less than 0.004% (at 1 kHz)
Channel separation More than 92 dB (at 1 kHz)
Wow & flutter Unmeasurable Limit
Output level/impedance
Fixed 2.0 V/1 k Ω
Digital output (DPF-J5010 only)
Optical -15 dBm ~ -21 dBm
(Wave length 660 nm)

[General]
Power consumption 10 W
Dimensions
W : 440 mm (17-5/16")
H : 173 mm (6-13/16")
D : 479 mm (18-7/8")
Weight (Net) 7.4 kg (16.3 lb)



1. KENWOOD follows a policy of continuous advancements in development. For this reason specifications may be changed without notice.
2. The full performance may not be exhibited in an extremely cold location (under a water-freezing temperature).

For the U.S.A.

FCC WARNING

This equipment may generate or use radio frequency energy. Changes or modifications to this equipment may cause harmful interference unless the modifications are expressly approved in the instruction manual. The user could lose the authority to operate this equipment if an unauthorized change or modification is made.

NOTE:

This equipment has been tested and found to comply with the limits for a Class B digital device, pursuant to Part 15 of the FCC Rules. These limits are designed to provide reasonable protection against harmful interference in a residential installation. This equipment may cause harmful interference to radio communications, if it is not installed and used in accordance with the instructions. However, there is no guarantee that interference will not occur in a particular installation. If this equipment does cause harmful interference to radio or television reception, which can be determined by turning the equipment off and on, the user is encouraged to try to correct the interference by one or more of the following measures:

- Reorient or relocate the receiving antenna.
- Increase the separation between the equipment and receiver.
- Connect the equipment into an outlet on a circuit different from that to which the receiver is connected.
- Consult the dealer or an experienced radio / TV technician for help.

For the U.S.A.

CAUTION:

Use of controls or adjustments or performance of procedures other than those specified herein may result in hazardous radiation exposure.

In compliance with Federal Regulations, following are reproductions of labels on, or inside the product relating to laser product safety.

KENWOOD CORPORATION
2967-3, ISHIKAWA-CHO, HACHIOJI-SHI,
TOKYO, JAPAN

KENWOOD CORP. CERTIFIES THIS EQUIPMENT CON-
FORMS TO DHHS REGULATIONS NO. 21 CFR 1040.10,
CHAPTER I, SUBCHAPTER J.

Location: Back Panel

KENWOOD

For your records

Record the serial number, found on the back of the unit, in the spaces designated on the warranty card, and in the space provided below. Refer to the model and serial numbers whenever you call upon your dealer for information or service on this product.

Model _____ Serial Number _____

Free Manuals Download Website

<http://myh66.com>

<http://usermanuals.us>

<http://www.somanuals.com>

<http://www.4manuals.cc>

<http://www.manual-lib.com>

<http://www.404manual.com>

<http://www.luxmanual.com>

<http://aubethermostatmanual.com>

Golf course search by state

<http://golfingnear.com>

Email search by domain

<http://emailbydomain.com>

Auto manuals search

<http://auto.somanuals.com>

TV manuals search

<http://tv.somanuals.com>