

KENWOOD

CD PLAYER

DPF-R 6030	CD-406
DPF-R 4030	CD-404
DPF-R 3030	CD-403

INSTRUCTION MANUAL

KENWOOD CORPORATION

This instruction manual is used to describe multiple models listed above. Model availability and features (functions) may differ depending on the country and sales area.

DTS disclaimer clause

When playing DTS-encoded CDs, excessive noise will be exhibited from the analog stereo outputs. To avoid possible damage to the audio system, the consumer should take proper pre-cautions when the analog stereo outputs of the CD player is connected to an amplification system. To enjoy DTS Digital Surround™ playback, an external 5.1 channel DTS Digital Surround™ decoder system must be connected to the digital output (S/PDIF, AES/EBU, or TosLink) of the CD player.



B60-4404-01 (EN)

Before applying power

 **Caution** : Read this page carefully to ensure safe operation.

Units are designed for operation as follows.

2 U.S.A. and Canada AC 120 V only
Australia AC 240 V only

Europe and U.K. AC 230 V only
China and Russia AC 220 V only
*Other countries AC 110-120 / 220-240 V switchable

For the United Kingdom

Factory fitted moulded mains plug

1. The mains plug contains a fuse. For replacement, use only a 13-Amp ASTA-approved (BS1362) fuse.
2. The fuse cover must be refitted when replacing the fuse in the moulded plug.
3. Do not cut off the mains plug from this equipment. If the plug fitted is not suitable for the power points in your home or the cable is too short to reach a power point, then obtain an appropriate safety approved extension lead or adapter, or consult your dealer. If nonetheless the mains plug is cut off, remove the fuse and dispose of the plug immediately, to avoid a possible shock hazard by inadvertent connection to the mains supply.

IMPORTANT: The wires in the mains lead are coloured in accordance with the following code:

Blue : Neutral
Brown : Live

Do not connect those leads to the earth terminal of a three-pin plug.

*AC voltage selection

The AC voltage selector switch on the rear panel is set to the voltage that prevails in the area to which the unit is shipped. Before connecting the power cord to your AC outlet, make sure that the setting position of this switch matches your line voltage. If not, it must be set to your voltage in accordance with the following direction.

AC voltage selector switch



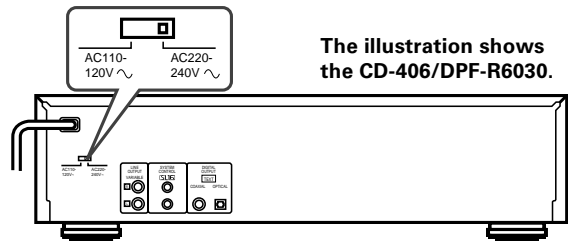

Move switch lever to match your line voltage with a small screwdriver or other pointed tool.



Note:
Our warranty does not cover damage caused by excessive line voltage due to improper setting of the AC voltage selector switch.

Safety precautions

WARNING : TO PREVENT FIRE OR ELECTRIC SHOCK, DO NOT EXPOSE THIS APPLIANCE TO RAIN OR MOISTURE.

	<p>CAUTION RISK OF ELECTRIC SHOCK DO NOT OPEN</p>		<p>CAUTION: TO REDUCE THE RISK OF ELECTRIC SHOCK, DO NOT REMOVE COVER (OR BACK). NO USER-SERVICEABLE PARTS INSIDE. REFER SERVICING TO QUALIFIED SERVICE PERSONNEL.</p>
	<p>THE LIGHTNING FLASH WITH ARROWHEAD SYMBOL, WITHIN AN EQUILATERAL TRIANGLE, IS INTENDED TO ALERT THE USER TO THE PRESENCE OF UNINSULATED "DANGEROUS VOLTAGE" WITHIN THE PRODUCT'S ENCLOSURE THAT MAY BE OF SUFFICIENT MAGNITUDE TO CONSTITUTE A RISK OF ELECTRIC SHOCK TO PERSONS.</p>		
	<p>THE EXCLAMATION POINT WITHIN AN EQUILATERAL TRIANGLE IS INTENDED TO ALERT THE USER TO THE PRESENCE OF IMPORTANT OPERATING AND MAINTENANCE (SERVICING) INSTRUCTIONS IN THE LITERATURE ACCOMPANYING THE APPLIANCE.</p>		

The marking of products using lasers (Except for some areas)

**CLASS 1
LASER PRODUCT**

The marking is located on the rear panel and says that the component uses laser beams that have been classified as Class 1. It means that the unit is utilizing laser beams that are of a weaker class. There is no danger of hazardous radiation outside the unit.

Unpacking

Unpack the unit carefully and make sure that all accessories are put aside so they will not be lost. Examine the unit for any possibility of shipping damage. If your unit is damaged or fails to operate, notify your dealer immediately. If your unit was shipped to you directly, notify the shipping company without delay. Only the consignee (the person or company receiving the unit) can file a claim against the carrier for shipping damage.

We recommend that you retain the original carton and packing materials for use should you transport or ship the unit in the future.

Keep this manual handy for future reference.

Accessories

Audio cord (1)

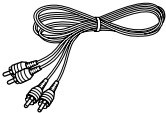

System control cord (1)

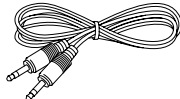

AC plug adaptor (1)

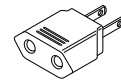

Remote control unit (1)
(Except for CD-403/DPF-R3030)

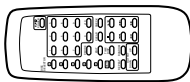

Batteries (R6/AA) (2)
(Except for CD-403/DPF-R3030)

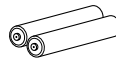

Use to adapt the plug on the power cord to the shape of the wall outlet. (Accessory only for regions where use is necessary.)

Special features

CD-TEXT support (CD-406/DPF-R6030 only)

- The text information such as disc title or track title (up to 1000 letters) recorded on the CDs can be easily called and displayed in alphanumeric. (Some words and text may not be displayed.) → 12

Advanced technologies incorporated in pursuit of improved sound quality and stability (CD-406/DPF-R6030 only)

- D.R.I.V.E. (Dynamic Resolution Intensive Vector Enhancement) IC is built in for drastic reduction of distortion at small signal level.

Convenient features for dubbing CD onto tape

- Edit mode is the function for rearranging tracks according to the tape length so that no music is interrupted in the middle. → 19
- Auto space function. → 15

Easy operation functions

- Easy operation functions allow systematic operation with other KENWOOD components connected through the system control connection. → 5



As an ENERGY STAR® Partner, Kenwood Corporation has determined that this products meets the ENERGY STAR® guidelines for energy efficiency.

This product can save energy. Saving energy reduces air pollution and lowers utility bills.

Contents

Caution: Read the pages marked carefully to ensure safe operation.

Before applying power	2	Programmed play (PGM mode)	13
Safety precautions	2	Playback in a random order (Random playback)	16
Unpacking	3	Repeated playback	17
Special features	3	Editing	19
System connections	4	Timer operations	21
Controls and indicators	6	Maintenance	22
Operation of remote control unit	8	In case of difficulty	23
Preparing to play tracks	9	Specifications	24
Normal play (TRACK mode)	10		
Displays	12		

System connections

4

Caution:

Do not plug in the power lead until all connections are completed.

Malfunction of microcomputer

If operation is not possible or erroneous display appears even though all connections have been made properly, reset the microcomputer referring to "In case of difficulty".

→ 23

Make connections as shown below.

When connecting the related system components, refer also to the instruction manuals of the related components.

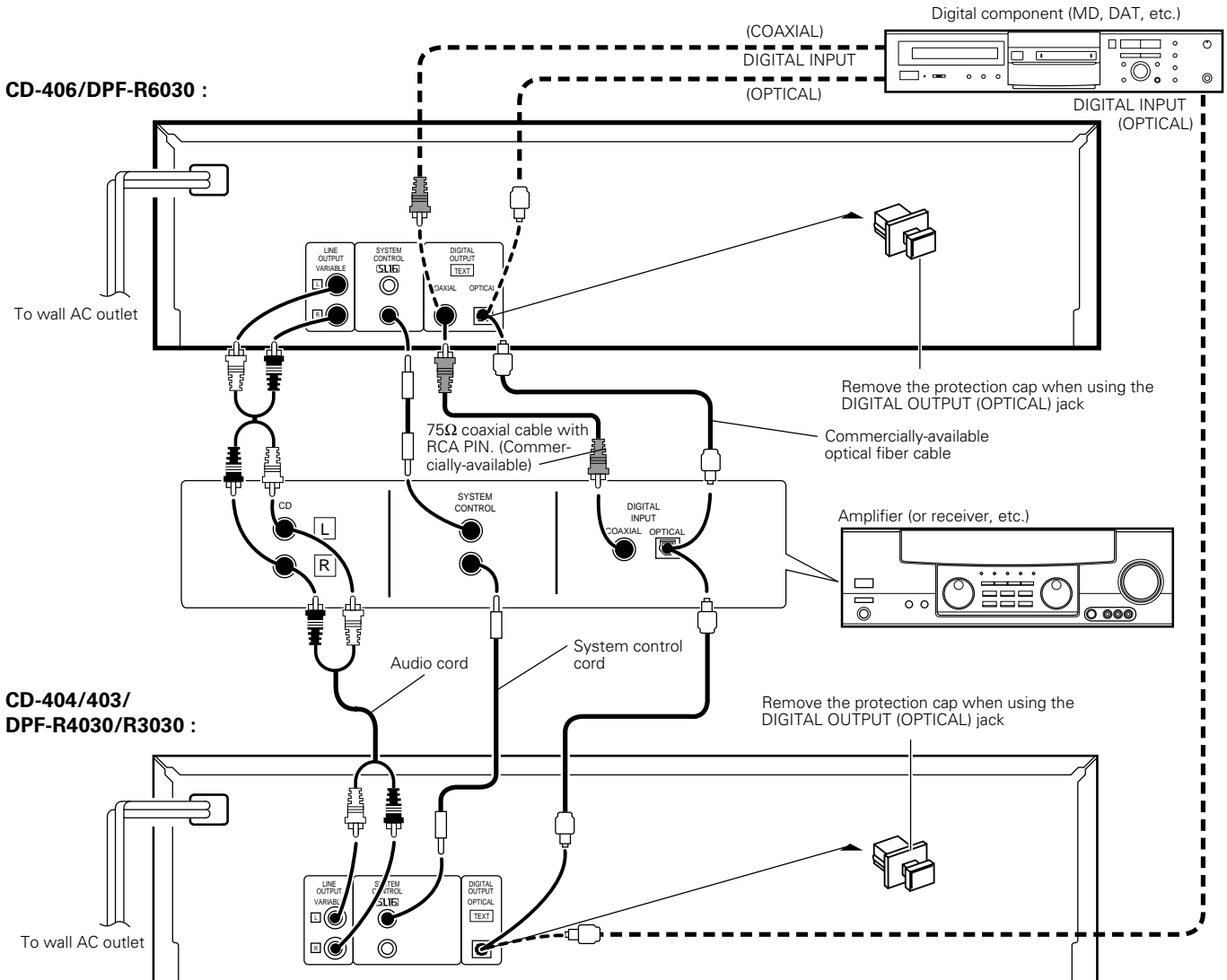

Connection to digital amplifier or MD

Connect the DIGITAL OUTPUT (OPTICAL or COAXIAL (CD-406/DPF-R6030 only)) jack to the digital input jack of the amplifier, DAT recorder, MD recorder, etc., using an optical fiber cable or coaxial cable which are commercially available in audio stores.

- When using an optical fiber cable to connect this unit to a digital amplifier, insert the plug straight into the jack until a snap sound is heard.
- Be careful not to bend, coil, or bundle the optical fiber cable.
- Optical fiber cables available on the market may not always be able to be used with this player. If your cord cannot be used with this unit, consult the store from which you purchased the cord or your nearest dealer.

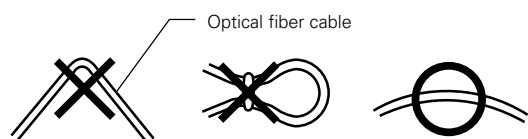

1. Connect all cords firmly. If connections are loose there could be loss of sound or noise produced.
2. When plugging and unplugging connection cords, be sure to first remove the power cord from the AC outlet. Plugging/unplugging connection cords without removal of the power cord can cause malfunctions or damage to the unit.

System control connections

Connecting system control cords after connecting a KENWOOD audio component system lets you take advantage of convenient system control operations.

This unit is compatible only with the [SL-16] mode. The system control operation is not available if the unit is connected in the [XS-8] connection mode.

If your component has the mode select switch, set the connected components to the [SL16] mode.

- You can connect the system control cord to either system control jack of the unit.

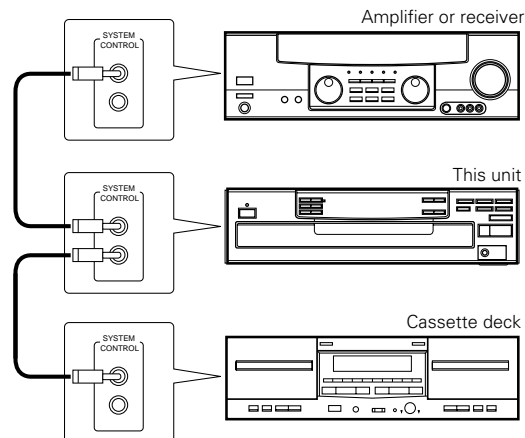

- If your amplifier or receiver does not have a system control terminal, do not connect any system control cords to the system control terminals on the other components.
- Do not connect system control cords to any components other than those specified by KENWOOD. It may cause a malfunction and damage your equipment.
- Be sure the system control plugs are inserted all the way in to the system control terminals.

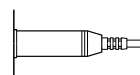

System control operations

Remote Control

Lets you operate this unit with the system remote control unit supplied with the amplifier or receiver.

Automatic Operation

Automatically switches the input selector on the amplifier or receiver when you start playback from this unit.

Synchronized Recording

Lets you synchronize recording with the start of playback when recording from a CD. Also, the simple CCRS operation enables great recordings from CDs.

See the operating instructions supplied with your cassette deck for details.

Adjusting the output levels of the output jacks and headphone output (Except for CD-403/DPF-R3030)

The OUTPUT level (UP/DOWN) keys of the remote control unit can adjust the output levels from the LINE/OUT and PHONES jack of the unit.

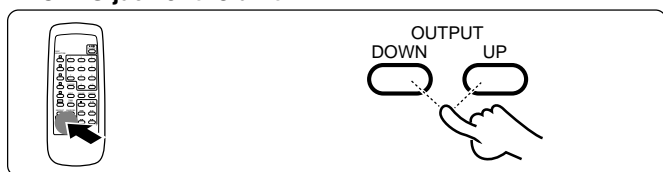

- It is not favorable for the sound quality to decrease the output level from this unit too much. Use these keys for coordination with other line levels.
- Adjusting the headphone output level also changes the LINE/OUT level. Do not adjust the output level from this unit particularly during recording.

To use the headphone (Except for CD-403/DPF-R3030)

Connect a stereo headphone to the PHONES jack of the CD player.

CD-406/DPF-R6030



CD-404/DPF-R4030

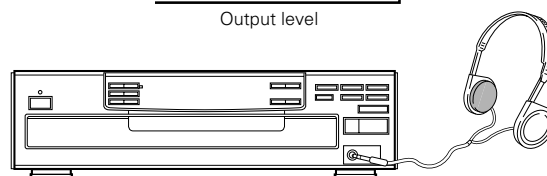
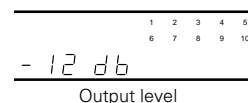

Controls and indicators

CD-406/DPF-R6030

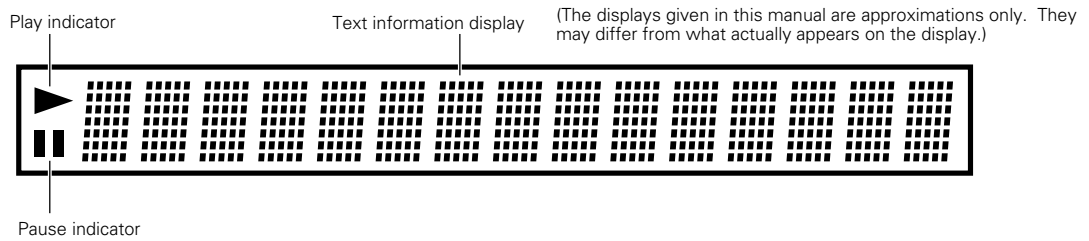

CD-404/403/DPF-R4030/R3030

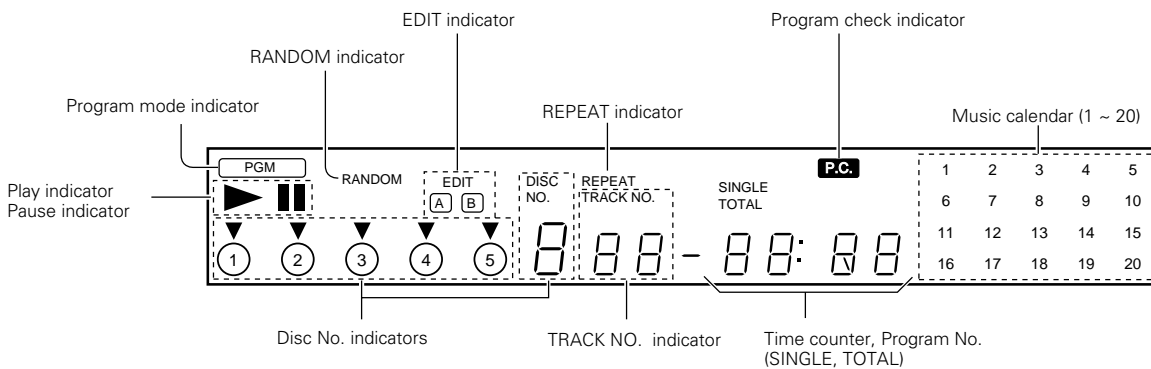



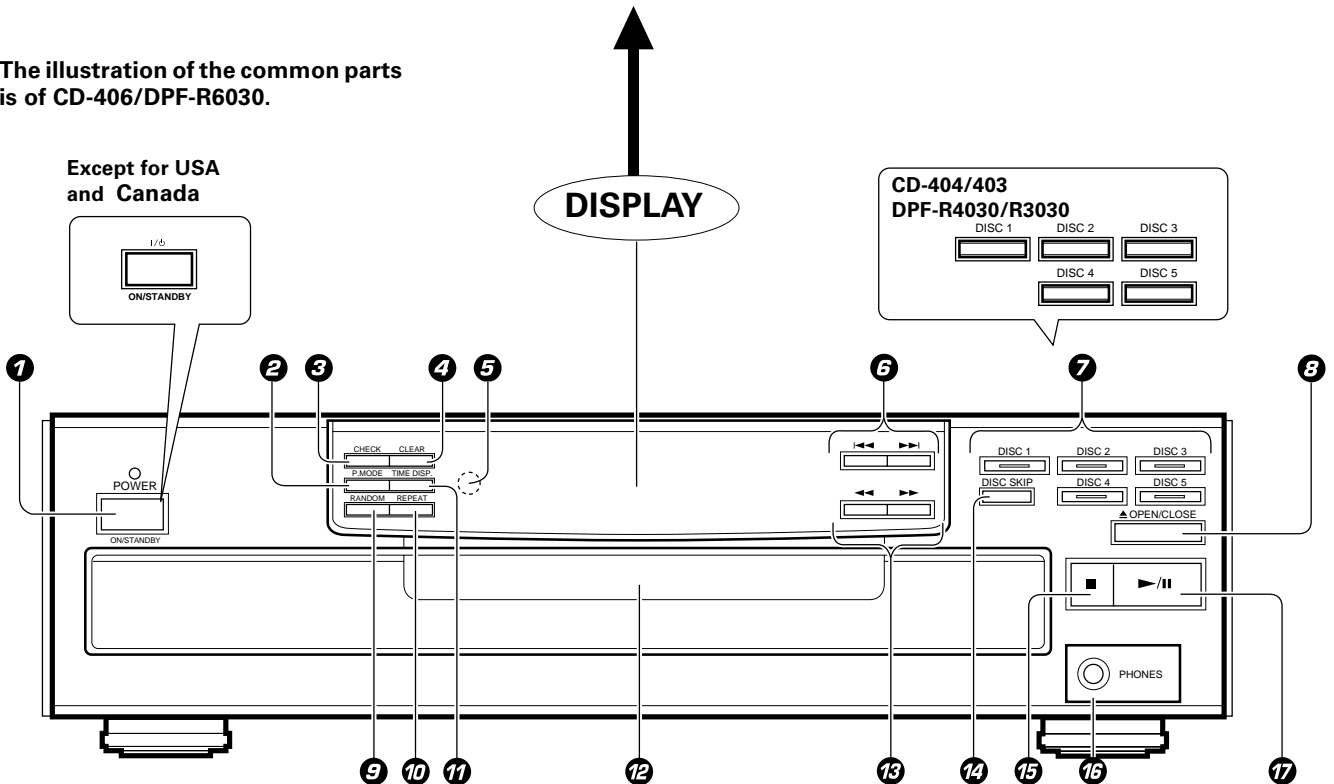













The illustration of the common parts is of CD-406/DPF-R6030.



Standby mode

While the standby indicator of the unit is lit, a small amount of current is flowing into the unit's internal circuitry to back up the memory. This condition is referred to as the standby mode of the unit. While the unit is in the standby mode, it can be turned ON from the remote control unit.

The keys with the same name as those on the remote control unit operate the same way as the remote control unit.

- | | | | |
|---|--|---|--|
| 1 ON/STANDBY (POWER / I / ⏻) key | →  9 | 9 RANDOM key | →  16 |
| Turns the unit ON/STANDBY. | | Press to play the tracks in a random order. | |
| 2 P.MODE key | →  13 | 10 REPEAT key | →  17 |
| Used for playback mode switching. | | Press to play the tracks repeatedly. | |
| 3 CHECK key | →  14 | 11 TIME DISP. key | →  12 |
| Used to check or change program contents. | | Press to switch the time indication mode. | |
| 4 CLEAR key | →  15 | 12 Disc tray | →  9 |
| Used to clear the program. | | Load the disc to be played back. | |
| 5 Remote control light sensor (CD-406/404/DPF-R6030/R4030 only) | →  8 | 13 Search (◀◀/▶▶) keys | →  11 |
| | | Fast forwards or fast reverses the track. | |
| 6 Skip (◀◀/▶▶) keys | →  11 | 14 DISC SKIP key | →  9 |
| Press to skip to the beginning of another track. | | Press to rotate the disc tray or to select the disc. | |
| 7 Disc selector keys (DISC1 – DISC5) / Indicator (CD-406/DPF-R6030 only) | →  10 | 15 Stop (■) key | →  10 |
| Press to select the disc to be played. | | 16 PHONES jack (CD-406/404/DPF-R6030/R4030 only) | →  5 |
| 8 OPEN/CLOSE (▲) key | →  9 | Use to connect (optional) headphones. | |
| Opens and closes the disc tray. | | 17 Play/pause (▶/⏸) key | →  10 |
| | | Each time the key is pressed, playback and pause switch each other. | |

Operation of remote control unit (Except for CD-403/DPF-R3030)

8

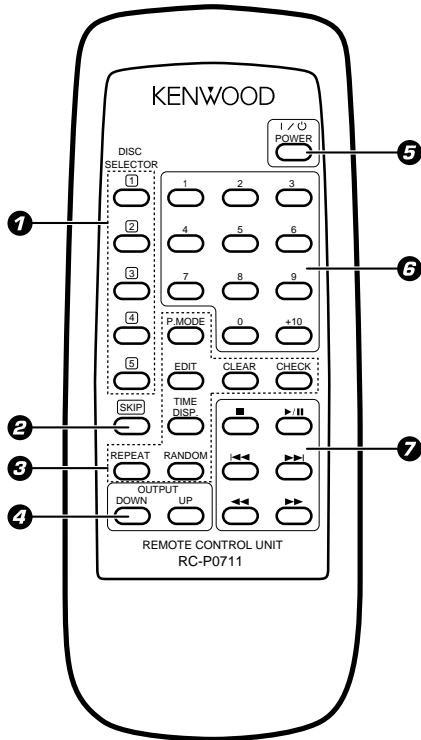

The keys with the same name as those on the main unit operate the same way as on the main unit. The keys marked * are provided only on the remote control unit.

1 DISC SELECTOR keys 2 DISC SKIP key	- 10 - 9	* 4 OUTPUT (DOWN, UP) keys - 5
3 Program-related and other keys RANDOM key REPEAT key P.MODE key TIME DISP. key * EDIT key CHECK key CLEAR key	- 16 - 17 - 13 - 12 - 19 - 14 - 15	5 POWER key - 9 * 6 Numeric keys (1 ~ 0, +10) - 11
		7 Basic function keys Stop key (■) - 10 Play/Pause key (▶/⏸) - 10 Skip (◀◀/▶▶) keys - 11 Search keys (◀◀/▶▶) - 11

Loading batteries

1 Remove the cover.

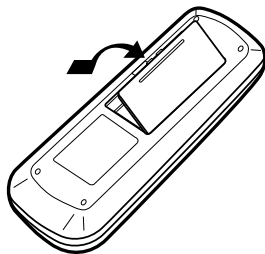

2 Insert batteries.

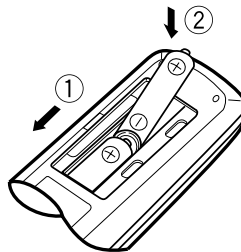

- Insert two AA-size (R6) batteries as indicated by the polarity marking.

3 Close the cover.

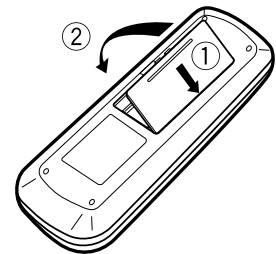

Operation

After plugging in the power cord, press the **ON/STANDBY (POWER/ I/⏻)** key of the main unit to turn the power ON. When the unit is turned ON, press the key of the function to be operated.

- When pressing more than one remote control key successively, press the keys securely by leaving an interval of 1 second or more between keys.

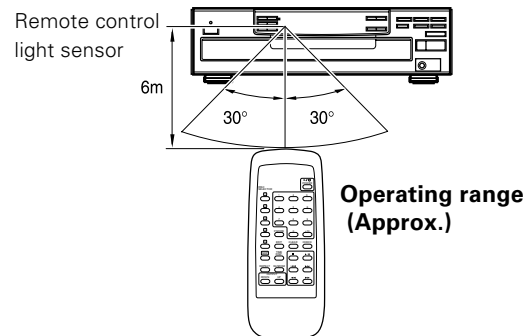

1. The supplied batteries are intended for use in operation checks. Therefore, their lives may be shorter than ordinary batteries.
2. When the remote-controllable distance gets shorter than before, replace both batteries with new ones.
3. Malfunction may occur if direct sunlight or the light of a high-frequency lighting fluorescent lamp enters the remote control light sensor. In such a case, change the system installation position to prevent the malfunction.

Preparing to play tracks

Preparation

- Turn the unit ON.

Press the ON/STANDBY (POWER / I/⏻) key.

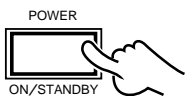

Loading/unloading discs

1 Load/unload a disc.

1 Open the tray.

2 Place/remove a disc.

3 When loading or unloading other discs

DISC SKIP

- Do not touch the played side of disc.

- When loading/unloading a disc while the tray rotates, a malfunction might occur. Load/unload the disc when the tray does not rotate.

2 Close the tray.

CD-406/DPF-R6030

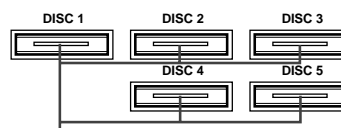

All DISC indicators "  " light regardless of how many discs are present.

CD-404/403/DPF-R4030/R3030



All DISC indicators "  " light regardless of how many discs are present.

Normal play (TRACK mode)

10

Use the following procedure to play a CD in the original order of tracks from track No. 1.

Playing tracks in order from track No. 1

1 Check that the unit is in the TRACK mode. → 

2 Start playback.

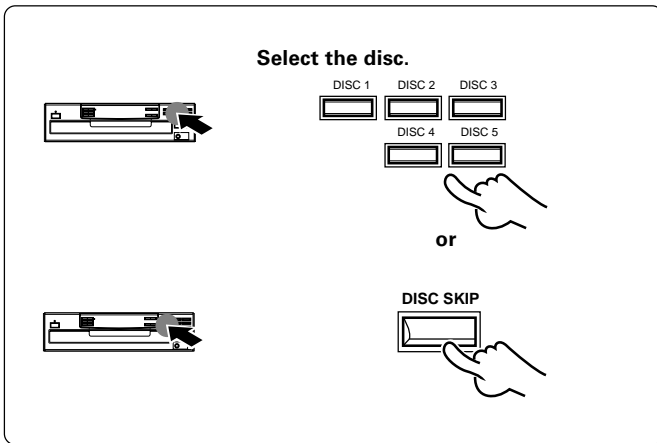

CD-406/DPF-R6030

If there is no disc in the selected disc tray, the corresponding indicator " " goes off.

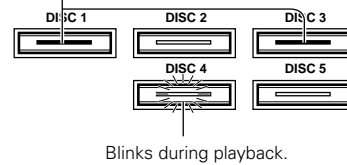

CD-404/403/DPF-R4030/R3030

If there is no disc in the selected disc tray, the corresponding indicator " " goes off.



- Playback starts from the disc selected in order of the DISC No.
- When the ►/|| key is pressed without selecting a disc, playback starts from the indicated DISC No.

CD-406/DPF-R6030

Lights up.

Track NO. being played

Elapsed time of track being played

- In the case of a CD-TEXT disc, the disc's title is scrolled on the display. You can change the display mode by pressing the **TIME DISP.** key. → 

CD-404/403/DPF-R4030/R3030

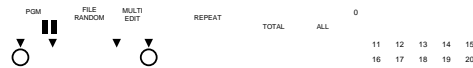

Disc indicator during Playback (▼)

Track NO. being played

Elapsed time of track being played

To pause playback

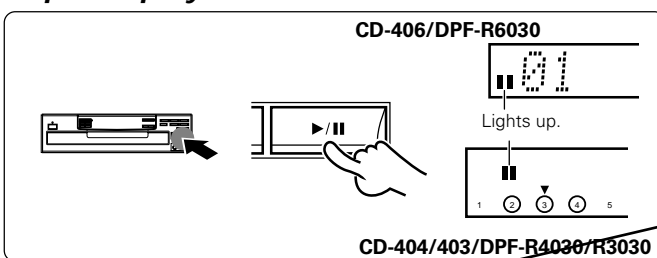

- Each press pauses and plays the CD alternately.

To stop playback

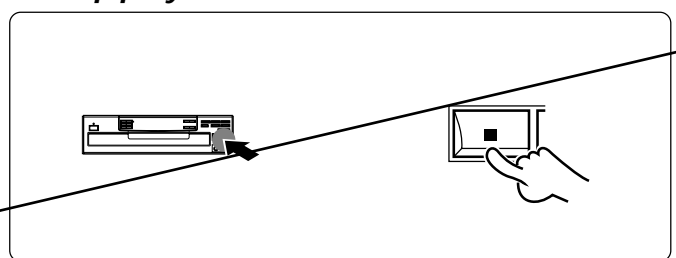

Playback from desired track

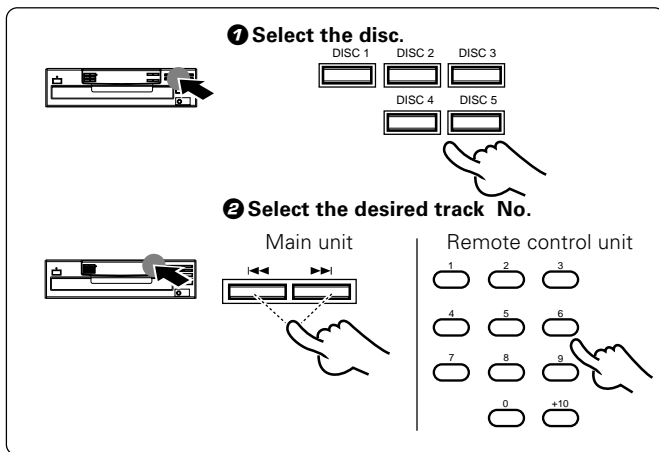

Press the numeric keys as shown below....

To enter track No. 23 : **+10, +10, 3**
To enter track No. 40 : **+10, +10, +10, +10, 0**

- Playback starts from the selected track and continues on the subsequent tracks.

Skipping tracks

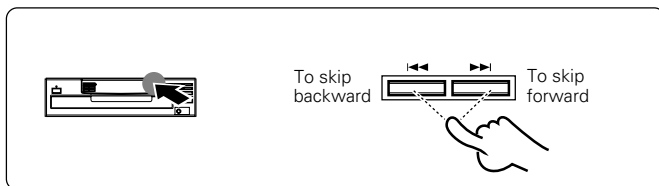

- The track in the direction of the pressed key is skipped, and the selected track will be played from the beginning.

Searching

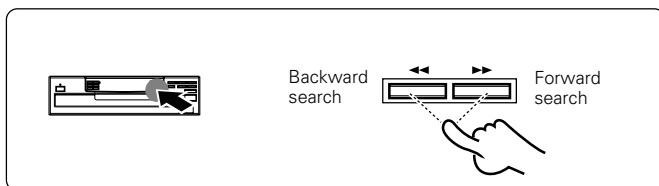

- Playback starts from the position where the key is released.

What is the "normal play (TRACK mode)"?

The TRACK mode refers to the state in which the PGM, EDIT, and RANDOM mode displays are off.

To set the unit to the TRACK mode:

Press the **P.MODE** key when the "PGM" or "EDIT" display is lighted.
Press the **RANDOM** key when the "RNDM" or "RANDOM" display is lighted.

CD-406/DPF-R6030

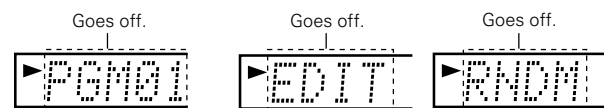

CD-404/403/DPF-R4030/R3030

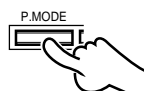
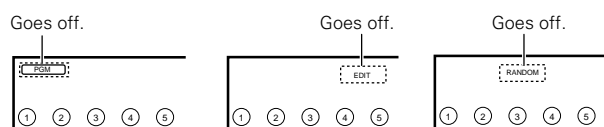

Displays

You can select the display type and check the disc information.

Preparation

- Load a disc in the CD player.



Each press the TIME DISP. key, the display changes as follows:

CD-406/DPF-R6030

During playback:

- ① Track title (Only when the current disc is a CD TEXT disc.)



- ② Elapsed time of the track now playing

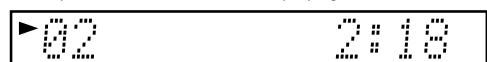

- ③ Remaining time of the track now playing

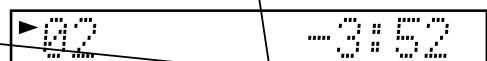

- ④ Elapsed time on the disc

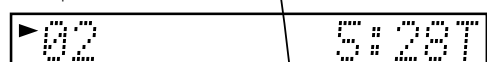

- ⑤ Total remaining time on the disc

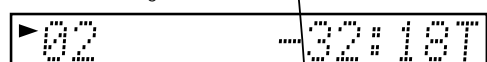

- ④ and ⑤ do not appear when the unit is in the PGM mode, RANDOM mode, or EDIT mode.

During stop mode:

Disc title (Only when the current disc is a CD TEXT disc.)

CD-404/403/DPF-R4030/R3030

During playback:

- ① Elapsed time of the track now playing



- ② Remaining time of the track now playing



- ③ Elapsed time on the disc



- ④ Total remaining time on the disc

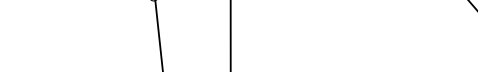

- ③ and ④ do not appear when the unit is in the PGM mode, RANDOM mode, or EDIT mode.

During stop mode:

Track and disk number

Track number

Display scrolling (CD-406/DPF-R6030 only)

Some titles contain so much text information that the full titles will not fit on the display. In cases like this, the letters on the display move from right to left so that the non-visible part of the title is revealed. This type of display movement is known as "scrolling display."

Display example



← Scroll display



Programmed play (PGM mode)

Use the following procedure to program desired tracks in a desired order. (up to 32 tracks)

Preparation

- Load a disc in the CD player.

1 Press so that the "PGM" indicator lights.

Do this operation in the stop mode.

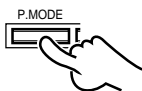

2 Program desired tracks.

1 Select the disc.

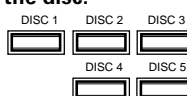
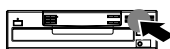

Go to step 2 within 8 seconds.

2 Select the desired track No.

Main unit

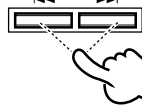
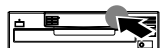

Remote control unit

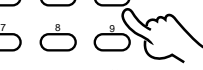
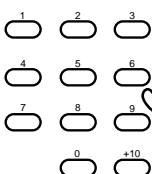

Go to step 3 within 8 seconds.

3 Set the entry.

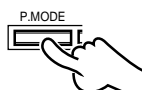

4 Repeat steps 1, 2 and 3 above.

3 Start playback.



CD-406/DPF-R6030



Blin

CD-404/403/DPF-R4030/R3030

Light up.



CD-406/DPF-R6030



Press the numeric keys as shown below...

To enter track No. 25 : +10, +10, 5



CD-404/403/DPF-R4030/R3030



Track number

- Up to 32 tracks can be programmed. When "FULL" is displayed, no more tracks can be programmed.
- If you make a mistake, press the **CLEAR** key and enter the track No. from the beginning.

- When the **⏮** or **⏭** key is pressed during playback, the track will be skipped in the direction of the pressed button.

To stop playback

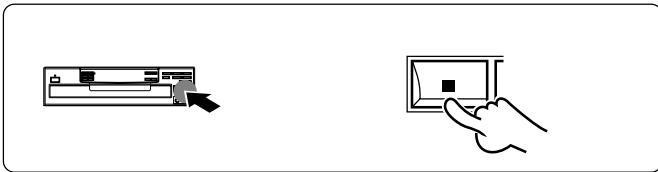

- The programmed contents remain in memory.

To check or change the programmed tracks

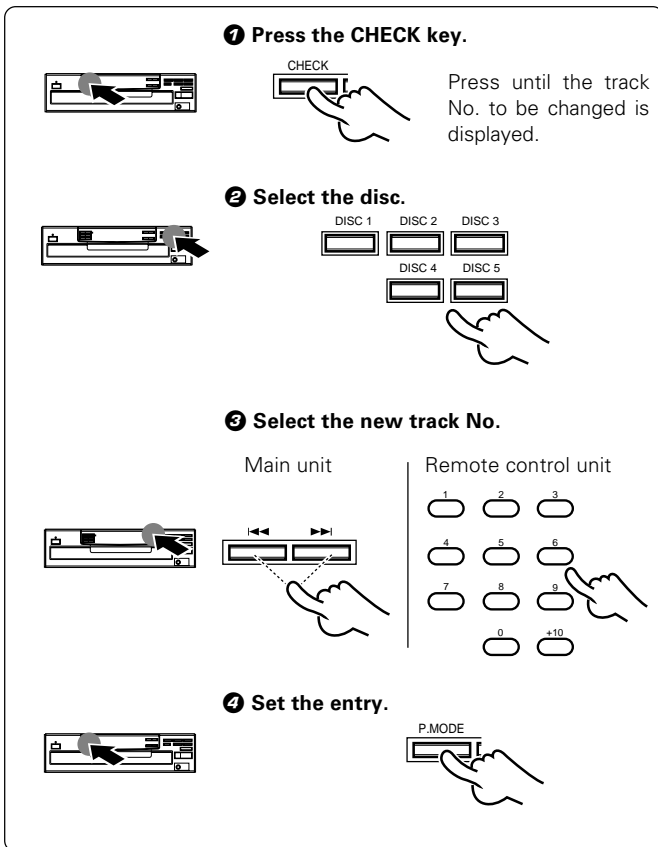

CD-406/DPF-R6030

Blinks.

CD-404/403/DPF-R4030/R3030

Light up

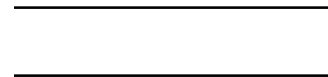

- Perform only step 1 to simply check the program.
- Each time the key is pressed, the program No. and the track No. on CD are displayed.

Example

- Press it while the "PGM 01" indicator blinks. (CD-406/DPF-R6030 only)
- Press the key while the "P.C." indicator is lit. (CD-404/403/DPF-R4030/R3030 only)
- The track being played cannot be changed.

To add a track to the program

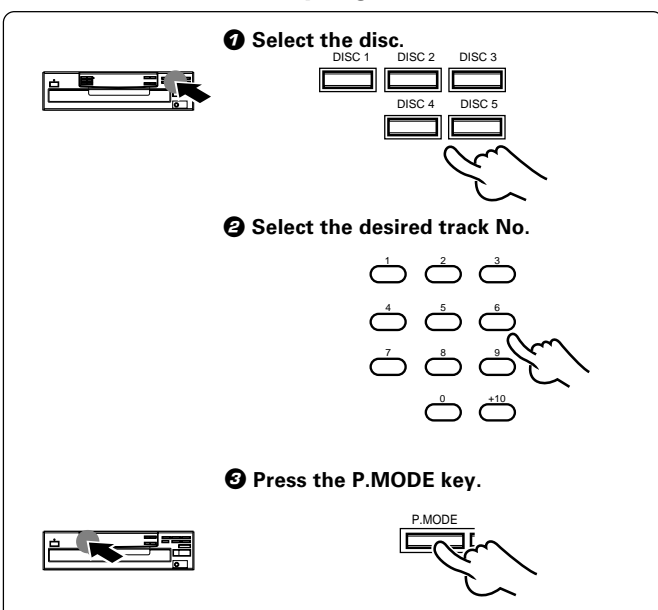

- When a track No. is selected, the track will be added to the end of the existing program.

To clear tracks from the program

Press to clear tracks from the end.

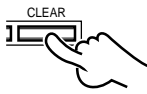

To clear all tracks

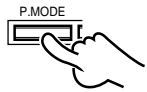

- Each time the key is pressed, the last track in the program is cleared.
- The tracks which are programmed earlier than the track being played cannot be cleared.

- Selected tracks can be also completely cleared just by operating the **OPEN/CLOSE (▲)** key.
- The entire program is cleared.

Auto space function

During programming of tracks, a non-recorded space of a few seconds will be automatically created between tracks. By recording tracks with these spaces on tape, the search and repeat play operations of tape using the DPSS function (which works by searching the non-recorded spaces) can be performed reliably.

- Even when the performances of two tracks are continuous (which occurs with classical or live recording music), the spaces will be created if they have different track Nos.

Playback in a random order (Random playback)

16 As tracks are selected at random, you can enjoy listening to for a long time.

Preparation • Load a disc in the CD player.

1 Check that the unit is in the TRACK mode. → 11

2 Press the RANDOM key.

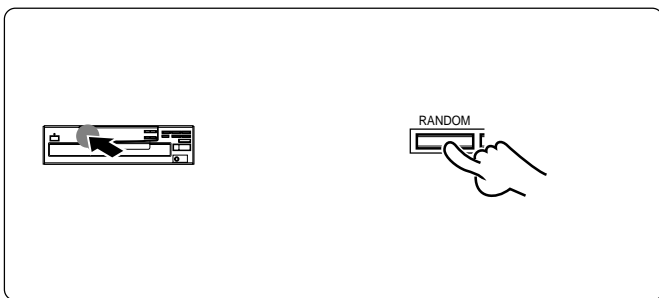

CD-406/DPF-R6030

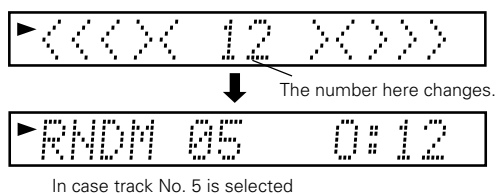

CD-404/403/DPF-R4030/R3030

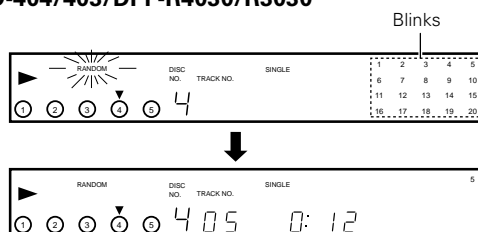

- Each time a track ends, the same operation as above is repeated, and the track selected next is played.
- Random play stops after all of the tunes have been played once.
- The random playback can also be repeated by pressing the **REPEAT** key.

To select another track in the middle of playing one

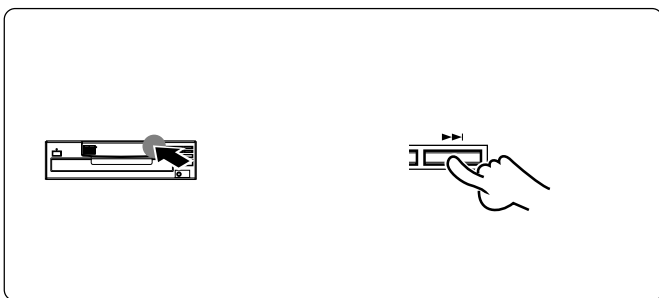

To cancel random playback

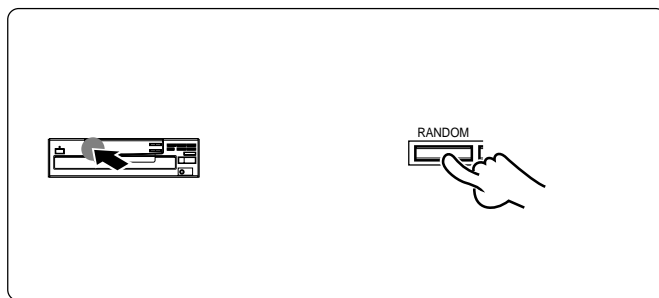

- Press the **RANDOM** key to start normal playback.

Re

Pre

To re

This a
load



R4030/R3030

PGM indicat



06/DPF-R6030

CD-404/403/DPF-R403

To repeat only the programmed tracks

1 Press so that the "PGM" indicator lights.



2 Select the disc.



Go to step 3 within 8 seconds.

3 Select the desired track number.

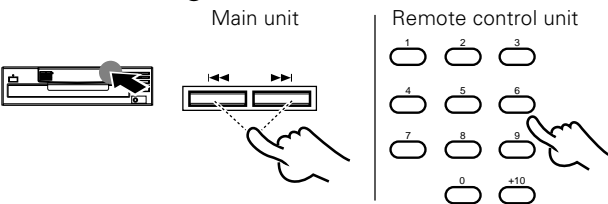

Go to step 4 within 8 seconds.

4 Set the entry.

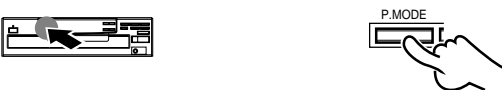

5 Repeat steps 2 - 4 above.

6 Press the REPEAT key.



For the CD-406/DPF-R6030

The current status is displayed when the key is pressed once. When it is pressed while the status is displayed, the repeat OFF status can be set to ON (or vice versa).

7 Start playback.



CD-406/DPF-R6030

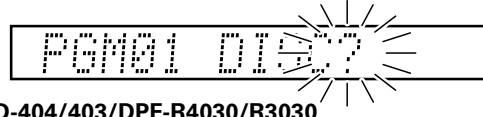

CD-404/403/DPF-R4030/R3030

PGM indicator lights up.

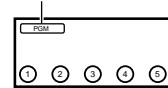

- All of the programmed tracks will be repeated.
- In case only one track is programmed, only that track will be repeated.
- Up to 32 tracks can be programmed. When "FULL" is displayed, no more tracks can be programmed.

CD-406/DPF-R6030



CD-404/403/DPF-R4030/R3030

REPEAT indicator lights up.



To cancel repeated playback

CD-406/DPF-R6030

Press the REPEAT key.

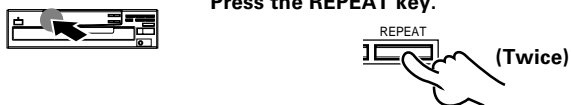

CD-404/403/DPF-R4030/R3030

Press the REPEAT key.



CD-406/DPF-R6030



CD-404/403/DPF-R4030/R3030

REPEAT indicator goes off.

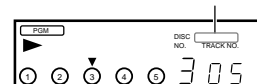



To check the edited contents

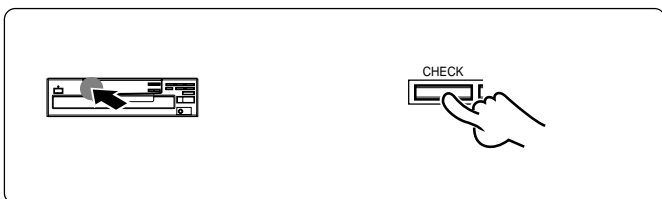

CD-406/DPF-R6030



- When the **CHECK** key is pressed, track numbers and remaining time in the file A are displayed first, then those in the file B.

CD-404/DPF-R4030

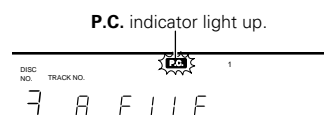

- When the **CHECK** key is pressed, the track Nos. of edited songs will automatically be displayed in the order they are edited.

Playing or recording the edited contents

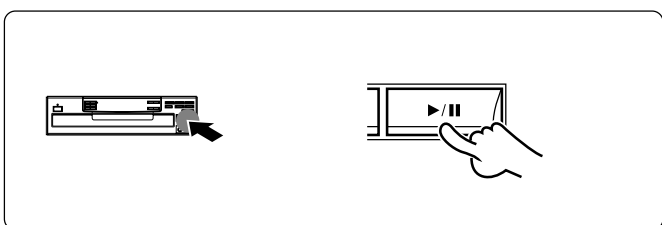

When recording the edited content onto a tape, it is recommended to use the synchro recording or CCRS recording function of KENWOOD cassette decks.

- Do not adjust the output level from this unit particularly during recording.
- With the CCRS function, the recording starts after about 1 minute.
- If you have a cassette deck capable of Double-speed recording, use Normal-speed recording.
- For details, see the instruction manual of the cassette deck.



Press the ►/|| key to start playback according to the edited content. The playback pauses at the beginning of the track edited for tape side B. Press the ►/|| key again to continue playback.

To clear the edited contents

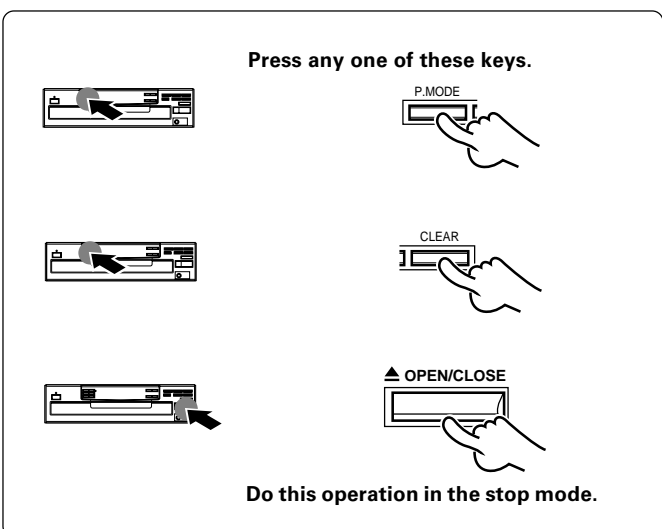

1. While you can edit with a different time setting to that of the tape you are using, part of the tape may be left with nothing recorded on it, or the last track on side A or side B may be cut short.
2. The EDIT function may not operate properly for discs having only one track or having tracks of long duration such as classical music.

Timer operation

Timer playback of CD audio timer which is available.

Preparation

- Check the operation of the timer.

• Check the operation of the timer.

an

This unit

System control cord

Audio cord

Amplifier or receiver

Audio timer

To wall AC outlet

1. Turn the power on.

2. Insert a disc.

3. Press the play button.

4. Press the timer button.

5. Press the stop button.

6. Adjust the amplifier volume.

7. Play the disc.

8. Adjust the amplifier volume.

9. Press the stop button.

- If the amplifier is not connected to the CD player through a system control cord, select the "CD" input with the input selector.

4. Set the timer.

Set the timer to the specified time.

The unit supplies power at the specified time.

- With some audio timer models, the power is automatically turned off when the timer expires.

5. Turn OFF the power timer.



1. Some amplifiers cannot be used with a timer. Before using an amplifier, check it.
2. When operating the unit other than CD player using an audio timer, be sure to remove the disc from the CD player.

Disc handling precautions

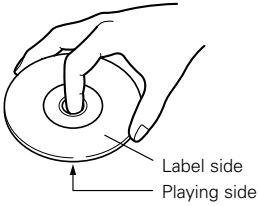

Handling

Hold the discs so that you do not touch the playing surface .

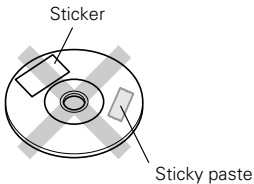

Do not attach paper or tape to either the playing side or the label side of the discs.

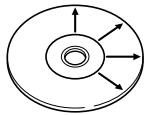

Cleaning

If fingerprints or foreign matter become attached to the disc, lightly wipe the disc with a soft cotton cloth (or similar) from the center of the disc outwards in a radial manner.

Storage

When a disc is not to be played for a long period of time, remove it from the player and store it in its case.

Discs which can be played with this unit

CD (12 cm, 8 cm) and the audio part of CDV, CD-G, CD-EG and CD-EXTRA.

Use discs that comply with the IEC standard, for example a disc carrying the  marking on the label surface.

Never play a cracked or warped disc.

During playback, the disc rotates at high speed in the player.

Therefore, to avoid danger, never use a cracked or deformed disc or a disc repaired with tape or adhesive agent.

Please do not use discs which are not round because they may cause a malfunction.

Disc accessories

The disc accessories (stabilizer, protection sheet, protection ring, etc.) which are marketed for improving the sound quality or protecting discs as well as the disc cleaner should not be used with this system because they may cause malfunction.

Maintenance of the unit

When the front panel or case becomes dirty, wipe with a soft, dry cloth. Do not use thinner, benzine, alcohol, etc. for these agents may cause discoloration.

In regard to contact cleaner

Do not use contact cleaners because it could cause a malfunction. Be specially careful not to use contact cleaners containing oil, for they may deform the plastic component.

Caution on condensation

Condensation (of dew) may occur inside the unit when there is a great difference in temperature between this unit and the outside. This unit may not function properly if condensation occurs. In this case, leave the unit for a few hours with the power left ON, and restart the operation after the condensation has dried up.

Be specially cautious against condensation in a following circumstance:

When this unit is carried from a place to another across a large difference in temperature, when the humidity in the room where this unit is installed increases, etc.

Note related to transportation and movement

Before transporting or moving this unit, carry out the following operations.



1. Turn the unit ON but do not load a disc.
2. Wait a few seconds and verify that the display shown appears.

CD-406/DPF-R6030

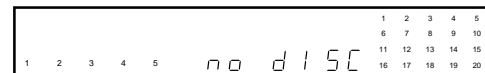

CD-404/403/DPF-R4030/R3030



3. Press the  OPEN/CLOSE key to open the disc tray completely.
4. Press the  OPEN/CLOSE key again to close the tray.
5. Wait a few seconds and set the unit to STANDBY mode.

In case of difficulty

What appears to be a malfunction may not always be serious. If your unit should not perform as expected, consult the table below to see if the problem can be corrected before seeking help from your dealer or service representative.

Operation to reset

The microcomputer may malfunction (impossibility to operate, erroneous display, etc.) when the connection cords are unplugged while the unit is ON or due to an external factor. In this case, execute the following method to reset the microcomputer and return it to normal condition.

Unplug the power cord from the power socket and plug the power cord into the socket again.

CD player unit

Symptom	Cause	Remedy
The unit is not turned ON with the ON/STANDBY (POWER/ /⏻) switch ON.	<ul style="list-style-type: none"> ● Power plug is loosely connected. ● With the power plug connected to the switched AC outlet of an amplifier, the power of the amplifier is turned off. 	<ul style="list-style-type: none"> ● Insert the power plug firmly to the AC outlet. ● Turn the amplifier's power ON.
Sound is not heard with the ▶/ key on.	<ul style="list-style-type: none"> ● Disc is loose. ● Disc is too dirty. ● Disc is cracked. ● Condensation has occurred on the optical lens unit. ● The connection cords are inserted loosely. ● Output level is attenuated too low. 	<ul style="list-style-type: none"> ● Insert disc properly. ● Wipe off the dust on the surface of the disc referring to "Disc handling precautions". → 22 ● Replace the disc with a new one. ● Remove any condensation from the unit by referring to the section entitled, "Caution on condensation". → 22 ● Connect all connection cords firmly. ● Adjust the output level with OUTPUT key on the remote control unit. → 5
Music is interrupted. (Sound is skipped.)	<ul style="list-style-type: none"> ● Disc is too dirty. ● Disc is cracked. ● Oscillation is applied to this unit. 	<ul style="list-style-type: none"> ● Wipe off the dust on the disc surface referring to "Disc handling precautions". → 22 ● Replace the disc with a new one. ● Try selecting a place where no strong vibrations occur by changing the installation place, etc.
Play begins as soon as the unit is turned ON.	<ul style="list-style-type: none"> ● This unit is designed so that play begins automatically when the unit is turned ON if a disc is already loaded. 	<ul style="list-style-type: none"> ● If automatic play is not required remove the disc from the player before setting the unit to STANDBY mode.

Remote control unit

Symptom	Cause	Remedy
Remote control operation is not possible.	<ul style="list-style-type: none"> ● Batteries are exhausted. ● The remote control unit is too far away from the main system, controlling angle is too large, or there is an obstacle in between. 	<ul style="list-style-type: none"> ● Replace with new batteries. → 8 ● Operate the remote control unit within the controllable range. → 8

Specifications

24

DPF-R6030 / CD-406

[Format]

System Compact disc digital audio system
Laser Semiconductor laser

[D/A Convertors]

D/A Conversion 1 Bit (D.R.I.V.E.)
Oversampling 8 fs (352.8 kHz)

[Audio]

Frequency response 4 Hz – 20 kHz, ± 0.5 dB
Signal to noise ratio More than 105 dB
Dynamic range More than 95 dB
Total harmonic distortion + noise
..... Less than 0.005% (at 1 kHz)

Wow & flutter Unmeasurable Limit
Output level/impedance

Variable (Max.) 2 V/1 k Ω

Digital output

Coaxial 0.5 V p-p / 75 Ω
Optical -15 dBm – -21 dBm
(Wave length 660 nm)

Headphone output (Max.) 20 mW (32 Ω)

[Laser]

Wave length 760 nm – 800 nm
Laser power class Class 1 (IEC)

[General]

Power consumption 14 W
Dimensions W : 440 mm (17-5/16")
H : 124.5 mm (4-15/16")
D : 398 mm (15-5/8")

Weight (Net) 5.1 kg (11.2 lb)

DPF-R4030/3030 / CD-404/403

[Format]

System Compact disc digital audio system
Laser Semiconductor laser

[D/A Convertors]

D/A Conversion 1 Bit
Oversampling 8 fs (352.8 kHz)

[Audio]

Frequency response 4 Hz – 20 kHz, ± 0.5 dB
Signal to noise ratio More than 100 dB
Dynamic range More than 93 dB
Total harmonic distortion + noise
..... Less than 0.005% (at 1 kHz)

Wow & flutter Unmeasurable Limit
Output level/impedance

Fixed (CD-403/DPF-R3030) 2 V/1 k Ω

Variable (CD-404/DPF-R4030) (Max.) 2 V/1 k Ω

Headphone output (Max.)

(CD-404/DPF-R4030 only) 20 mW (32 Ω)

[Laser]

Wave length 760 nm – 800 nm
Laser power class Class 1 (IEC)

[General]

Power consumption 14 W
Dimensions W : 440 mm (17-5/16")
H : 124.5 mm (4-15/16")
D : 398 mm (15-5/8")

Weight (Net) 5.1 kg (11.2 lb)



1. KENWOOD follows a policy of continuous advancements in development. For this reason specifications may be changed without notice.
2. The full performance may not be exhibited in an extremely cold location (under a water-freezing temperature).

KENWOOD

For your records

Record the serial number, found on the back of the unit, in the spaces designated on the warranty card, and in the space provided below. Refer to the model and serial numbers whenever you call upon your dealer for information or service on this product.

Model _____ Serial Number _____

Free Manuals Download Website

<http://myh66.com>

<http://usermanuals.us>

<http://www.somanuals.com>

<http://www.4manuals.cc>

<http://www.manual-lib.com>

<http://www.404manual.com>

<http://www.luxmanual.com>

<http://aubethermostatmanual.com>

Golf course search by state

<http://golfingnear.com>

Email search by domain

<http://emailbydomain.com>

Auto manuals search

<http://auto.somanuals.com>

TV manuals search

<http://tv.somanuals.com>