

# KENWOOD

DIGITAL SURROUND AMPLIFIER

## KAF-S500

---

### INSTRUCTION MANUAL

KENWOOD CORPORATION

***About the supplied remote control***

Compared to standard remote controls, the remote control supplied with this amplifier has several operation modes. These modes enable the remote control to control other audio/video components. In order to effectively use the remote control, it is important to read the operating instructions and obtain a proper understanding of the remote control and how to switch its operation modes (etc.). Using the remote control without completely understanding its design and how to switch the operation modes may result in incorrect operations.

# Before applying the power

 **Caution : Read this page carefully to ensure safe operation.**

Units are designed for operation as follows.

U.S.-Military ..... AC 110 - 240 V

## How to use this manual

This manual is divided into four sections, Preparations, Operations, Remote Control, and Additional Information.

### Preparations

Shows you how to connect your audio and video components to the receiver and prepare the surround processor.

Since this receiver works with all your audio and video components, kindly follow the instructions in this manual for the correct connections.

### Operations

Shows you how to operate the various functions available on the receiver.

### Remote Control

Shows you how to operate other components using the remote control, as well as a detailed explanation of all remote control operations. Once you have registered your components with the proper setup codes, you'll be able to operate both this receiver and your other AV components (TV, VCR, DVD player, CD player, etc.) using the remote control supplied with this receiver.

### Additional Information

Shows you additional information such as "In case of difficulty" (troubleshooting) and "Specifications".

#### Maintenance of the unit

When the front panel or case becomes dirty, wipe with a soft, dry cloth. Do not use thinner, benzine, alcohol, etc. for these agents may cause discoloration.

#### In regard to contact cleaner

Do not use contact cleaners because it could cause a malfunction. Be specially careful not to use contact cleaners containing oil, for they may deform the plastic component.

#### For the U.S.A.

#### FCC WARNING

This equipment may generate or use radio frequency energy. Changes or modifications to this equipment may cause harmful interference unless the modifications are expressly approved in the instruction manual. The user could lose the authority to operate this equipment if an unauthorized change or modification is made.

#### NOTE:

This equipment has been tested and found to comply with the limits for a Class B digital device, pursuant to Part 15 of the FCC Rules. These limits are designed to provide reasonable protection against harmful interference in a residential installation. This equipment may cause harmful interference to radio communications, if it is not installed and used in accordance with the instructions. However, there is no guarantee that interference will not occur in a particular installation. If this equipment does cause harmful interference to radio or television reception, which can be determined by turning the equipment off and on, the user is encouraged to try to correct the interference by one or more of the following measures:

- Reorient or relocate the receiving antenna.
- Increase the separation between the equipment and receiver.
- Connect the equipment into an outlet on a circuit different from that to which the receiver is connected.
- Consult the dealer or an experienced radio / TV technician for help.

## Unpacking

Unpack the unit carefully and make sure that all accessories are present.

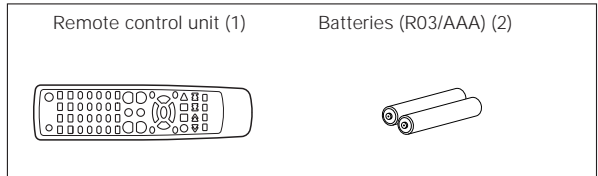





If any accessories are missing, or if the unit is damaged or fails to operate, notify your dealer immediately. If the unit was shipped to you directly, notify your shipper immediately. Kenwood recommends that you retain the original carton and packing materials in case you need to move or ship the unit in the future.

**Keep this manual handy for future reference.**

## Safety precautions

### WARNING :

TO PREVENT FIRE OR ELECTRIC SHOCK,  
DO NOT EXPOSE THIS APPLIANCE TO  
RAIN OR MOISTURE.

	<b>CAUTION</b> RISK OF ELECTRIC SHOCK DO NOT OPEN	
CAUTION: TO REDUCE THE RISK OF ELECTRIC SHOCK, DO NOT REMOVE COVER (OR BACK). NO USER-SERVICEABLE PARTS INSIDE. REFER SERVICING TO QUALIFIED SERVICE PERSONNEL.		
	THE LIGHTNING FLASH WITH ARROWHEAD SYMBOL, WITHIN AN EQUILATERAL TRIANGLE, IS INTENDED TO ALERT THE USER TO THE PRESENCE OF UNINSULATED "DANGEROUS VOLTAGE" WITHIN THE PRODUCT'S ENCLOSURE THAT MAY BE OF SUFFICIENT MAGNITUDE TO CONSTITUTE A RISK OF ELECTRIC SHOCK TO PERSONS.	
	THE EXCLAMATION POINT WITHIN AN EQUILATERAL TRIANGLE IS INTENDED TO ALERT THE USER TO THE PRESENCE OF IMPORTANT OPERATING AND MAINTENANCE (SERVICING) INSTRUCTIONS IN THE LITERATURE ACCOMPANYING THE APPLIANCE.	

## Special features

---

### True home theater sound

This amplifier incorporates a wide variety of surround modes to bring you maximum enjoyment from your video software. Select a surround mode according to your equipment or the software you are going to play and enjoy! → [21]

### Dolby Digital and Dolby Digital EX

The DOLBY DIGITAL mode lets you enjoy full digital surround from software processed in the Dolby Digital format. Dolby Digital provides up to 5.1 channels of independent digital audio for better sound quality and more powerful presence than conventional Dolby Surround. As for Dolby Digital EX, it creates six full-bandwidth output channels from the 5.1 channel sources. This is done using a matrix decoder that derives three surround channels from the two in the original recording. For best results, Dolby Digital EX should be used with movie soundtracks recorded with Dolby Digital Surround EX.

### Dolby PRO LOGIC II

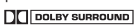
Dolby PRO LOGIC II, whilst totally compatible with its predecessor PRO LOGIC, provides greater advantages in surround sound. It allows the user to enjoy the conventional stereo or Dolby Surround with a convincing "5.1 like" presentation. PRO LOGIC II offers special features for controlling the overall spatial, dimensionality and frontal sound field imaging. PRO LOGIC II produces an impressive surround sound from video software marked  and three-dimensional space from music CD. When listening to music, you will be able to enjoy the experience of sheer STEREO surround sound.

### DTS and DTS-ES

DTS (Digital Theater System) is a 5.1 channel digital audio format that provides five full spectrum channels and one low-frequency (subwoofer) channel for unprecedented clarity, optimum channel separation and a (wide) dynamic range.

DTS-ES (Extended Surround) presents 6.1 channels surround system with additional Back Surround channel which evolved from the conventional 5.1 channels surround system. DTS-ES format that was recorded in DVD, CD or LD comprises of two modes. DTS-ES Discrete 6.1 produce the discrete back surround which is completely independent and DTS-ES Matrix 6.1 produces the back surround which synthesized within the left and right surround channels using matrix technology. DTS-ES has perfect compatibility with the conventional 5.1 channels surround system. 6.1 channels surround with an additional surround back presents a more natural presence and surround effects by increasing the impression of the sound image from back.

Important:

When a DTS disc is played on a CD, LD or DVD player, noise may be output from the analog output. It is recommended that you connect the digital output of the player to the digital input of this unit.

### Neo:6

Neo:6 is a new technology which was developed by DTS. It can produce high grade 6 channels surround with an astonishing fidelity from 2 channels content. Neo:6 has 2 mode, "CINEMA" mode is for movie playback and "MUSIC" mode is for music playback.

### SRS TruSurround

There are only two speakers but you will be searching for others. SRS TruSurround can take in any mono, stereo, or multiple channel source, such as Dolby Digital and immerse you into a field sound you would have thought impossible through two speakers.

### DSP surround modes

The DSP (Digital Signal Processor) used for this receiver incorporates a variety of high quality adjustable sound fields, like "ARENA", "JAZZ CLUB", "STADIUM", "DISCO" and "THEATER". It is compatible with almost any kind of program source.

### ACTIVE EQ





ACTIVE EQ mode will produce a more dynamic sound quality in any condition. You can enjoy a more impressive sound effect when ACTIVE EQ is turned on during Dolby Digital and DTS playback.

### Universal IR (InfraRed) remote control

In addition to the basic receiver, the remote control supplied with this receiver can also operate almost all of your remote controllable audio and video components. Just follow the simple setup procedure to register the components you have connected.

## Contents

Caution : Read the pages marked  carefully to ensure safe operation.

<b>Preparations</b>	<b> Before applying the power ..... 2</b>
	How to use this manual ..... 2
	Unpacking ..... 2
	 Safety precautions ..... 2
	Special features ..... 3
	<b> IMPORTANT SAFEGUARDS ..... 5</b>
	<b>Names and functions of parts ..... 7</b>
	Main unit ..... 7
	Remote control unit ..... 8
	<b>Setting up the system ..... 9</b>
	Connecting audio components ..... 10
	Connecting the speakers (for HTB-S500 system) ..... 11
	Connecting the speakers (for KAF-S500) ..... 12
Connecting the terminals ..... 13	
Connecting to the FRONT AUX jacks ..... 14	
Preparing the remote control ..... 14	
<b>Preparing for surround sound ..... 15</b>	
Speaker settings ..... 15	
<b>Operations</b>	<b>Normal playback ..... 18</b>
	Preparing for playback ..... 18
	Listening to a source component ..... 18
	Adjusting the sound ..... 19
	<b>Recording ..... 20</b>
	Recording audio (analog sources) ..... 20
	<b>Ambience effects ..... 21</b>
	Surround modes ..... 21
	Surround play ..... 23
	SRS TruSurround play ..... 24
	<b>Convenient functions ..... 25</b>
Adjutment of each channel's level ..... 25	
Midnight mode (Dolby Digital mode only) ..... 25	
Display dimmer adjutment ..... 25	
Sleep timer (SLEEP) ..... 25	
96kHz LPCM playback ..... 25	
<b>Remote Control</b>	<b>Basic remote control operations for other components ..... 26</b>
	Registering setup codes for other components ..... 26
	Operating other components ..... 27
	Setup code chart ..... 28
	Other components' operations ..... 32
<b>Additional Information</b>	<b> In case of difficulty ..... 34</b>
	<b>Specifications ..... 35</b>

# IMPORTANT SAFEGUARDS

**⚠ Caution : Read this page carefully to ensure safe operation.**

Please read all of the safety and operating instructions before operating this appliance. Adhere to all warnings on the appliance and in the instruction manual. Follow all the safety and operating instructions. These safety and operating instructions should be retained for future reference.

- 1. Power sources** – The appliance should be connected to a power supply only of the type described in the instruction manual or as marked on the appliance. If you are not sure of the type of power supply to your home, consult your appliance dealer or local power company. For appliances intended to operate from battery power, or other sources, refer to the instruction manual.
- 2. Power-cord protection** – Power-supply cords should be routed so that they are not likely to be walked on or pinched by items placed upon or against them, pay particular attention to cords at plugs, convenience receptacles, and the point where they exit from the appliance.

Never pull or stretch the cord.



- 3. CAUTION – Polarization** – This appliance may be equipped with a polarized alternating-current line plug (a plug having one blade wider than the other). This plug will fit into the power outlet only one way. This is a safety feature. If you are unable to insert the plug fully into the outlet, try reversing the plug. If the plug should still fail to fit, contact your electrician to replace your obsolete outlet. Do not defeat the safety purpose of the polarized plug.

- 4. Ventilation** – Slots and openings in the cabinet are provided for ventilation and to ensure reliable operation of the appliance and to protect it from overheating, and these openings must not be blocked or covered. The appliance should be situated so that its location or position does not interfere with its proper ventilation.

To maintain good ventilation, do not put records or a table-cloth on the appliance. Place the appliance at least 10 cm away from the walls.

Do not use the appliance on a bed, sofa, rug or similar surface that may block the ventilation openings. This appliance should not be placed in a built-in installation such as a bookcase or rack unless proper ventilation is provided or the manufacturer's instructions have been adhered to.

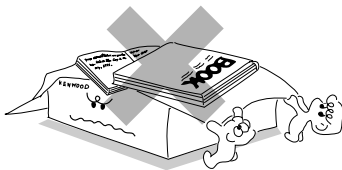

- 5. Water and moisture** – The appliance shall not be exposed to dripping and splashing - for example, near a bathtub, washbowl, kitchen sink, laundry tub, in a wet basement, or near a swimming pool, etc. Do not place an object containing liquid, such as a flower vase, on the appliance.

- 6. Temperature** – The appliance may not function properly if used at extremely low, or freezing temperatures. The ideal ambient temperature is above +5°C (41°F).

- 7. Heat** – The appliance should be situated away from heat sources such as radiators, heat registers, stoves, or other appliances (including amplifiers) that produce heat. Do not place a flaming object, such as a candle or lantern, on or near the appliance.

- 8. Electric shock** – Care should be taken so that objects do not fall and liquid is not spilled into the enclosure through openings. If a metal objects, such as a hair pin or a needle, comes into contact with the inside of this appliance, a dangerous electric shock may result. For families with children, never permit children to put anything, especially metal, inside this appliance.

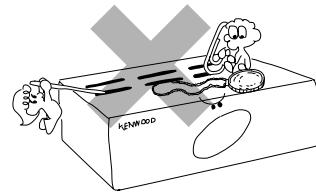

- 9. Enclosure removal** – Never remove the enclosure. If the internal parts are touched accidentally, a serious electric shock might occur.

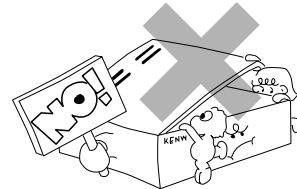

- 10. Magnetic fields** – Keep the appliance away from sources of magnetic fields such as TV sets, speaker systems, radios, motorized toys or magnetized objects.

- 11. Cleaning** – Unplug this appliance from the wall outlet before cleaning. Do not use volatile solvents such as alcohol, paint thinner, gasoline, or benzine, etc. to clean the cabinet. Use a clean dry cloth.

- 12. Accessories** – Do not place this appliance on an unstable cart, stand, tripod, bracket, or table. The appliance may fall, causing serious injury to a child or adult, and serious damage to the appliance. Use only with a cart, stand, tripod, bracket, or table recommended by the manufacturer, or sold with the appliance. Any mounting of the appliance should follow the manufacturer's instructions, and should use a mounting accessory recommended by the manufacturer. An appliance and cart combination should be moved with care. Quick stops, excessive force, and uneven surfaces may cause the appliance and cart combination to overturn.



# IMPORTANT SAFEGUARDS

**⚠ Caution :** Read this page carefully to ensure safe operation.

**13. Lightning** – For added protection for this appliance during a lightning storm, or when it is left unattended and unused for long periods of time, unplug it from the wall outlet and disconnect the antenna or cable system. This will prevent damage to the appliance due to lightning and power-line surges.

**14. Abnormal smell** – If an abnormal smell or smoke is detected, immediately turn the power OFF and unplug the appliance from the wall outlet. Contact your dealer or nearest service center.

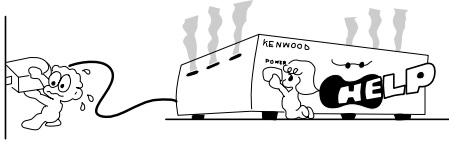

**15. Damage requiring service** – The appliance should be serviced by qualified service personnel when:

- A. The power-supply cord or the plug has been damaged.
- B. Objects have fallen, or liquid has been spilled into the appliance.
- C. The appliance has been exposed to rain or water.
- D. The appliance does not appear to operate normally by following the instruction manual. Adjust only those controls that are covered by the instruction manual as an improper adjustment of other controls may result in damage and will often require extensive work by a qualified technician to restore the appliance to its normal operation.
- E. The appliance has been dropped, or the enclosure damaged.
- F. The appliance exhibits a marked change in performance.

**16. Servicing** – The user should not attempt to service the appliance beyond that described in the instruction manual. All other servicing should be referred to qualified service personnel.

**17. Outdoor antenna grounding** – If an outside antenna is connected to the appliance, be sure the antenna system is grounded so as to provide some protection against voltage surges and built up static charges. Article 810 of the National Electrical Code ANSI/NFPA 70, provides information with respect to proper grounding of the mast and supporting structure, grounding of the lead-in wire to an antenna discharge unit, size of grounding conductors, location of antenna discharge unit, connection to grounding electrodes, and requirements for the grounding electrode. See Figure.

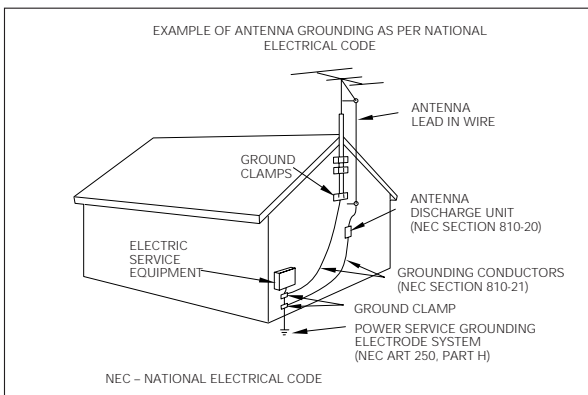

**18. Power lines** – An outside antenna system should not be located in the vicinity of overhead power lines or other electric light or power circuits, or where it can fall into such power lines or circuits. When installing an outside antenna system, extreme care should be taken to keep from touching such power lines or circuits as contact with them might be fatal.

**19. AC outlets** – Do not connect other audio equipment with a power consumption larger than that specified to the AC outlet on the rear panel. Never connect other electrical appliances, such as an iron or toaster, to it to prevent fire or electric shock.

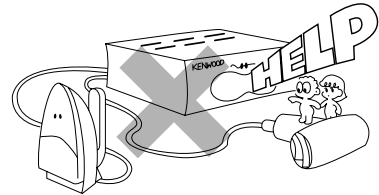

**20. Overloading** – Do not overload wall outlets, extension cords, or integral convenience receptacles as this can result in a risk of fire or electric shock.

**21. Attachment** – Do not use attachments not recommended by the appliance manufacturer as they may cause hazards.

**22. Replacement parts** – When replacement parts are required, be sure the service technician has used replacement parts specified by the manufacturer or have the same characteristics as the original parts. Unauthorized substitutions may result in fire, electric shock, or other hazards.

**23. Safety check** – Upon completion of any service or repairs to this appliance, ask the service technician to perform safety checks to determine that the appliance is in proper operating condition.

**Notes:**

- 1. Item 3 is not required except for grounded or polarized equipment.
- 2. Item 17 and 18 are not required except for units provided with antenna terminals.
- 3. Item 17 complies with UL in the U.S.A.

# Names and functions of parts

## Main unit

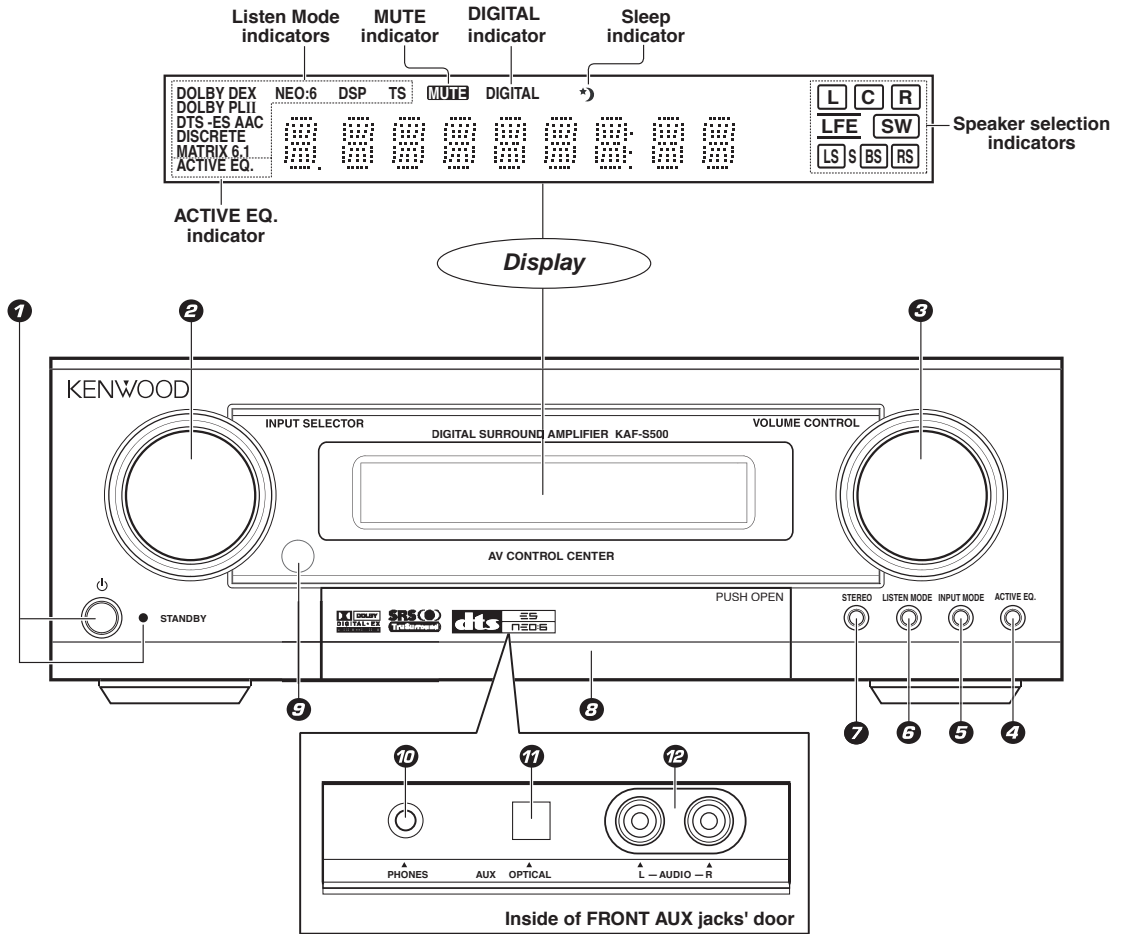

- |   |  |
|---|--|
| <p><b>1</b>  (POWER) key <span style="float: right;">- [15]</span><br/>Use to turn the main power on or off.<br/><b>STANDBY indicator</b><br/>Lights when stand by mode.</p> <p><b>2</b> <b>INPUT SELECTOR knob</b> <span style="float: right;">- [18]</span><br/>(DVD/CD, VIDEO 1, VIDEO 2, FRONT AUX)<br/>Use to select input sources.</p> <p><b>3</b> <b>VOLUME CONTROL knob</b> <span style="float: right;">- [18]</span></p> <p><b>4</b> <b>ACTIVE EQ key</b> <span style="float: right;">- [19]</span><br/>Use to select ACTIVE EQ's setting.</p> <p><b>5</b> <b>INPUT MODE key</b> <span style="float: right;">- [9]</span><br/>Use to switch between the full auto, digital and analog inputs.</p> <p><b>6</b> <b>LISTEN MODE key</b> <span style="float: right;">- [23]</span><br/>Use to select the listening mode.</p> | <p><b>7</b> <b>STEREO key</b> <span style="float: right;">- [23]</span><br/>Use to switch the listen mode to STEREO.</p> <p><b>8</b> <b>Door for FRONT AUX jacks</b> <span style="float: right;">- [14] - [19]</span><br/>When you use FRONT AUX jacks, push right side of this door and then pull the door to open.</p> <p><b>9</b> <b>Remote sensor</b> <span style="float: right;">- [14]</span></p> <p><b>10</b> <b>PHONES jack</b> <span style="float: right;">- [19]</span><br/>Use for headphone listening.</p> <p><b>11</b> <b>INPUT AUX (Digital in) jack</b></p> <p><b>12</b> <b>FRONT AUX (L-AUDIO-R) jacks</b> <span style="float: right;">- [14]</span></p> |
|---|--|

### Standby mode

While the standby indicator is lit, a small amount of power is supplied to the system to back up the memory. This is called standby mode. Under the condition, the system can be turned ON by remote control unit.

## Remote control unit

This remote control unit can be used not only for Kenwood products but also for other non-Kenwood products by setting the appropriate manufacturer's setup codes. → 28

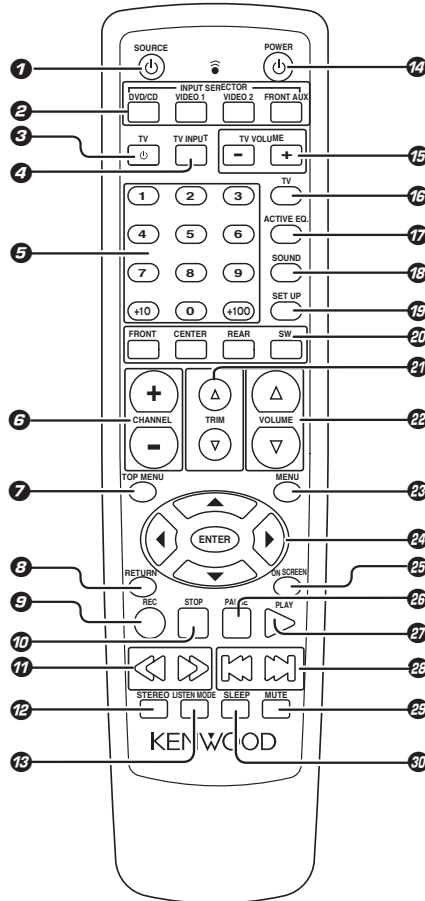

If the name of a function is different on the receiver and on the remote control, the name of the remote control key in this manual is indicated in parentheses.

- |  |   |  |
|--|---|--|
| <p><b>1 SOURCE</b>  key <span style="float: right;">→ 26</span><br/>Use to turn the other components on or off.</p> <p><b>2 INPUT SELECTOR keys</b> (DVD/CD, VIDEO 1, VIDEO 2, FRONT AUX) <span style="float: right;">→ 18</span><br/>Use to select input sources.</p> <p><b>3 TV</b>  key <span style="float: right;">→ 32</span><br/>Use to turn the TV on or off.</p> <p><b>4 TV INPUT</b> key <span style="float: right;">→ 32</span><br/>Use when in TV operation.</p> <p><b>5 Numeric keys</b> <span style="float: right;">→ 26</span><br/>Provide functions identical to those of the original remote control supplied with the component you are controlling.</p> <p><b>6 CHANNEL +/-</b> keys <span style="float: right;">→ 32 - 33</span><br/>Use to select the channels.</p> <p><b>7 TOP MENU</b> key <span style="float: right;">→ 33</span><br/>Use to operate the DVD component.</p> <p><b>8 RETURN</b> key <span style="float: right;">→ 33</span><br/>Use to operate the DVD component.</p> <p><b>9 REC</b> (●) key <span style="float: right;">→ 32</span><br/>This key functions as record key for other components.</p> <p><b>10 STOP</b> (■) key <span style="float: right;">→ 32 - 33</span><br/>This key functions as the stop key for other components.</p> | <p><b>11</b>  keys <span style="float: right;">→ 32 - 33</span><br/>These keys function as search keys for other components.</p> <p><b>12 STEREO</b> key <span style="float: right;">→ 23</span><br/>Use to which the listen mode to STEREO.</p> <p><b>13 LISTEN MODE</b> key <span style="float: right;">→ 23</span><br/>Use to select the listening mode.</p> <p><b>14 POWER</b>  key <span style="float: right;">→ 15</span><br/>Use to turn the amplifier on or off.</p> <p><b>15 TV VOLUME +/-</b> keys <span style="float: right;">→ 32</span><br/>Use to adjust the TV's volume.</p> <p><b>16 TV</b> key <span style="float: right;">→ 32</span><br/>Use when in TV operation.</p> <p><b>17 ACTIVE EQ.</b> key <span style="float: right;">→ 19</span><br/>Use to select ACTIVE EQ's setting.</p> <p><b>18 SOUND</b> key <span style="float: right;">→ 19 - 25</span><br/>Use to adjust the sound quality and the ambience effects.</p> <p><b>19 SET UP</b> key <span style="float: right;">→ 15</span><br/>Use to select the speakers' settings etc.</p> <p><b>20 SPEAKERS</b> keys <span style="float: right;">→ 25</span><br/>Use to select FRONT, CENTER, REAR, and SW speakers.</p> | <p><b>21 TRIM</b>  keys <span style="float: right;">→ 15</span><br/>Use to control a variety of settings.</p> <p><b>22 VOLUME</b>  keys <span style="float: right;">→ 18</span><br/>Use to adjust the receiver's volume.</p> <p><b>23 MENU</b> key <span style="float: right;">→ 33</span><br/>Use to operate other components.</p> <p><b>24</b>  keys <span style="float: right;">→ 33</span><br/>Use to operate other components.</p> <p><b>ENTER</b>  key <span style="float: right;">→ 26 - 33</span><br/>Use to operate other components.</p> <p><b>25 ON SCREEN</b> key <span style="float: right;">→ 26</span><br/>Use to operate other components.</p> <p><b>26 PAUSE</b> (  ) key <span style="float: right;">→ 32 - 33</span><br/>This key functions as the pause key for other components.</p> <p><b>27 PLAY</b> (▶) key <span style="float: right;">→ 32 - 33</span><br/>This key functions as the play key for other components..</p> <p><b>28</b>  keys <span style="float: right;">→ 33</span><br/>These keys function as skip keys for other components.</p> <p><b>29 MUTE</b> key <span style="float: right;">→ 19</span><br/>Use to temporary mute the sound.</p> <p><b>30 SLEEP</b> key <span style="float: right;">→ 25</span><br/>Use to setup sleep timer.</p> |
|--|---|--|



# Setting up the system

Make connections as shown in the following pages. When connecting the related system components, be sure to refer to the instruction manuals supplied with the components you are connecting. Do not connect the power cord to a wall outlet until all connections are completed.

## Note

Be sure to insert all connection cords securely. If their connections are imperfect, sound may not be produced or there will be noise interference.

## Analog connections

Audio connections are made using RCA pin cords. These cables transfer stereo audio signal in an "analog" form. This means the audio signal corresponds to the actual audio of two channels. These cables usually have 2 plugs on each end, one red for the right channel and one white for the left channel. These cables are usually packed together with the source unit, or are available at your local electronics retailer.

## Microcomputer malfunction

If operation is not possible or an erroneous display appears, even though all connections have been made properly, reset the microcomputer referring to "In case of difficulty". → [34]

## CAUTION

Be sure to adhere to the following, or proper ventilation will be blocked causing damage or fire hazard.

- Do not place any objects impairing heat radiation onto the top of the unit.
- Leave some space around the unit (from the largest outside dimension including projection) equal to or greater than, shown below.

Top panel : 50 cm Side panel : 10 cm Back panel : 10 cm

## Input mode settings

DVD/CD, VIDEO 2 and FRONT AUX inputs each include jacks for digital audio input and analog audio input.

The initial factory settings for audio signal playback for DVD/CD, VIDEO 2 and FRONT AUX.

After completing connections and turning on the amplifier, follow the steps below.

### INPUT SELECTOR

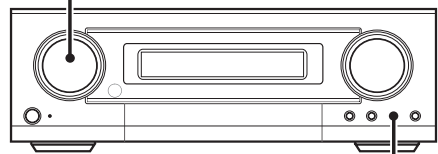

INPUT MODE

① Use the Input Selector keys to select DVD/CD, VIDEO 2 or FRONT AUX.

② Press the INPUT MODE key.

Each press switches the setting as follows:

In DVD/CD, VIDEO 2 or FRONT AUX play mode

- ① FULL AUTO (digital input, analog input)
- ② D.MANUAL (digital input)
- ③ ANALOG (analog input)

In DTS play mode

- ① FULL AUTO (digital input, analog input)
- ② D.MANUAL (digital input)

### Digital input:

Select this setting to play digital signals from a DVD, CD, or LD player.

### Analog input:

Select this setting to play analog signals from a cassette deck, VCR, or record player.

### Auto detect:

In "FULL AUTO" mode (FULL AUTO displayed), the amplifier detects the digital or analog input signals automatically. Priority is given to digital signal during input mode selection. The receiver will select the input mode and listening mode automatically during playback to match the type of input signal (Dolby Digital, PCM, DTS) and the speaker setting. The DIGITAL indicator on the display will light up when digital signal is detected during FULL AUTO mode or during D.MANUAL mode. If the input signal is analog, the DIGITAL indicator will go off.

To keep the amplifier set to the currently selected listening mode, use the INPUT MODE key to select "D.MANUAL" (manual sound). However, even when this setting is selected, there may be cases in which the listening mode is selected automatically to match a Dolby Digital source signal depending on the combination of listening mode and source signal.

At D.MANUAL, if the audio reproduction stops in the middle due to change in the input signals, etc. press the LISTEN MODE knob. If the INPUT MODE key is pressed quickly, sound may not be produced. Press the INPUT MODE key again.

## Connecting audio components

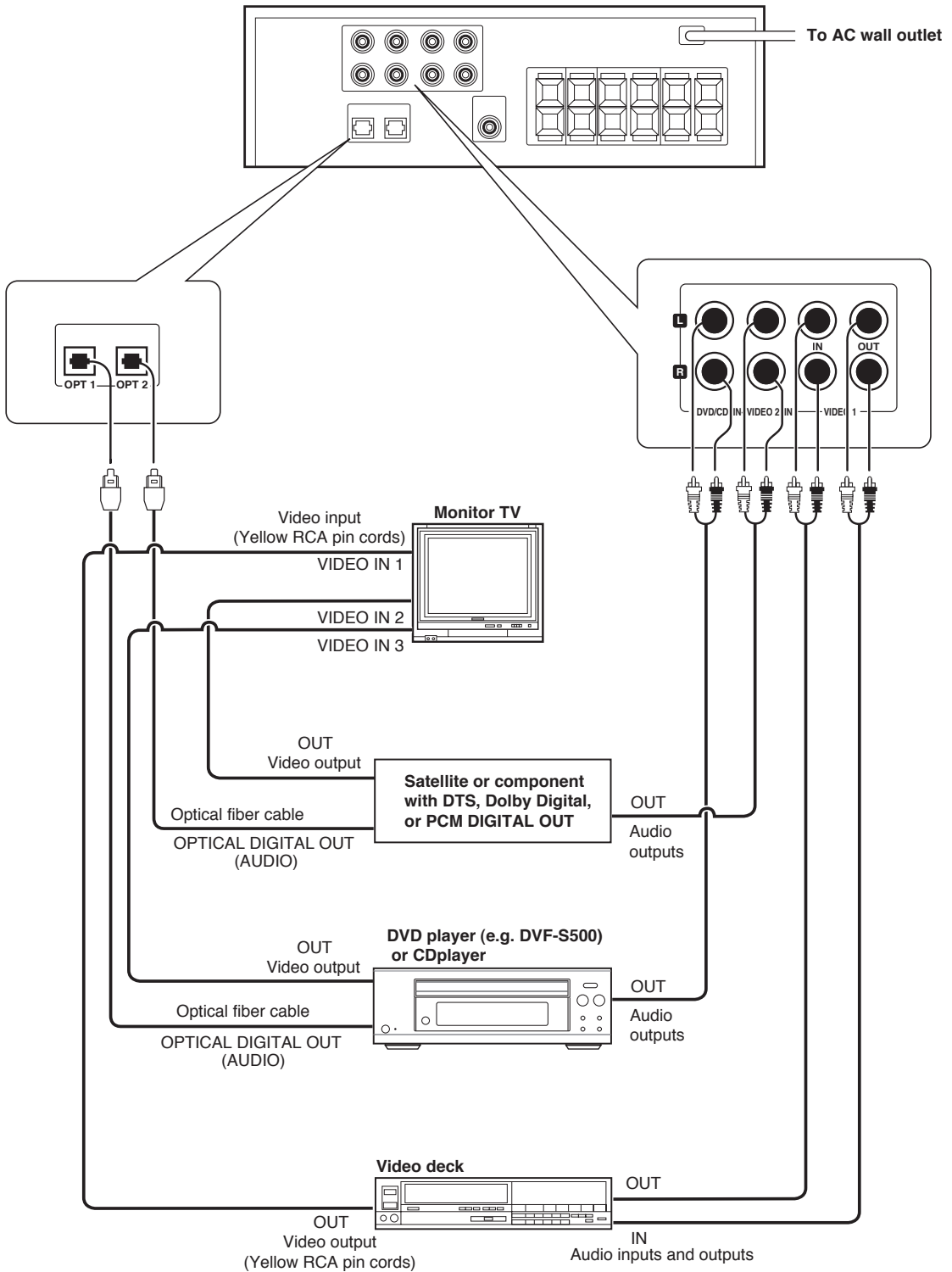

## Connecting the speakers (for HTB-S500 system)

Connect terminals of same color between rear panel and speakers.  
Also use speaker cord which have same colored tube as terminal.  
White lined wire is for  $\oplus$  polarity.

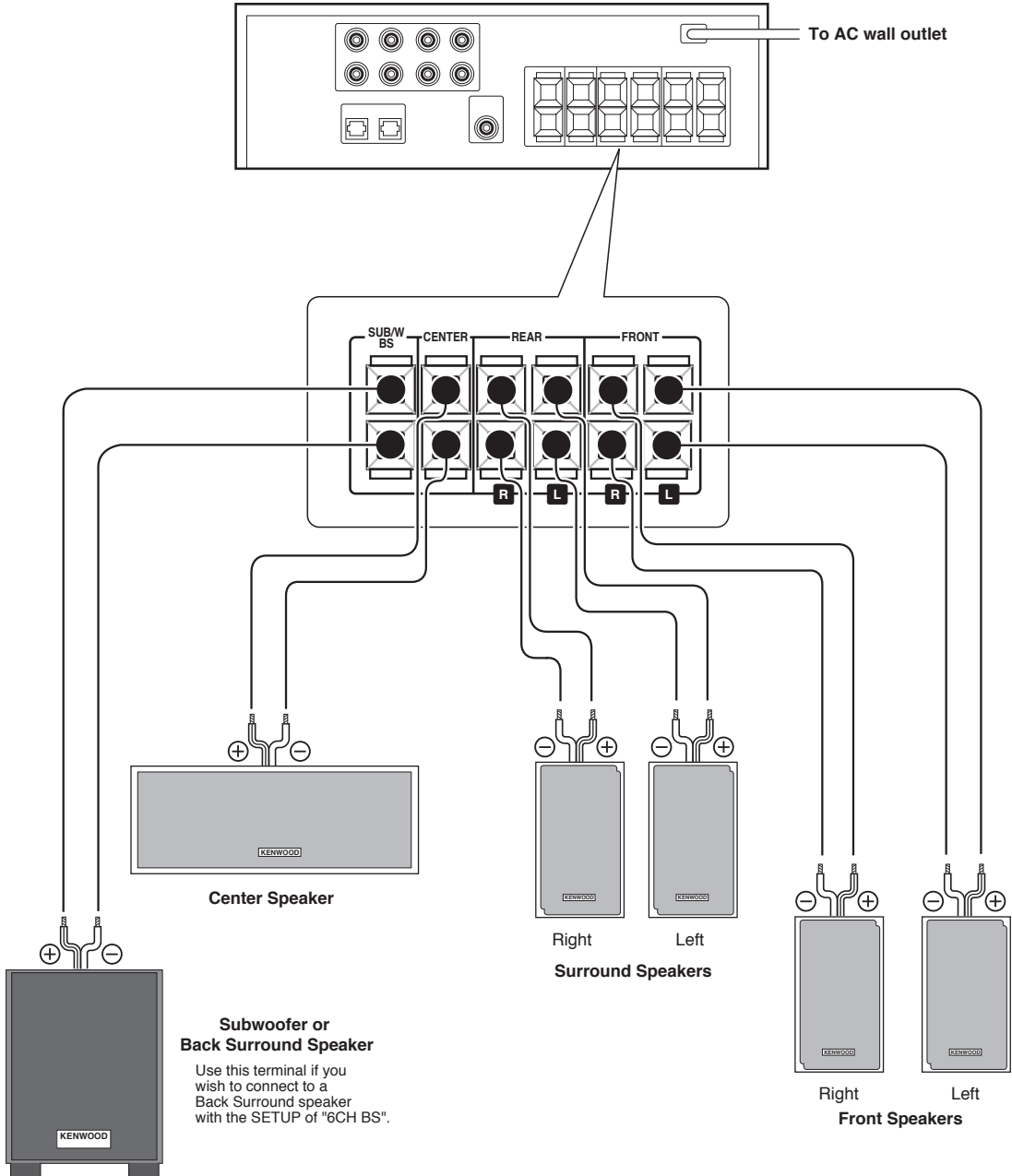

### Supplied speaker seals

Front speakers and surround speakers have screw holes to fix to speaker stand. If you don't use these holes, stick supplied seals to hide holes.

### Supplied speaker cushions

Stick the supplied four cushions to the bottom of the speakers. (except subwoofer) It is effective for slip-proof and deaden vibrations of placed speakers.

## Connecting the speakers ( for KAF-S500 )

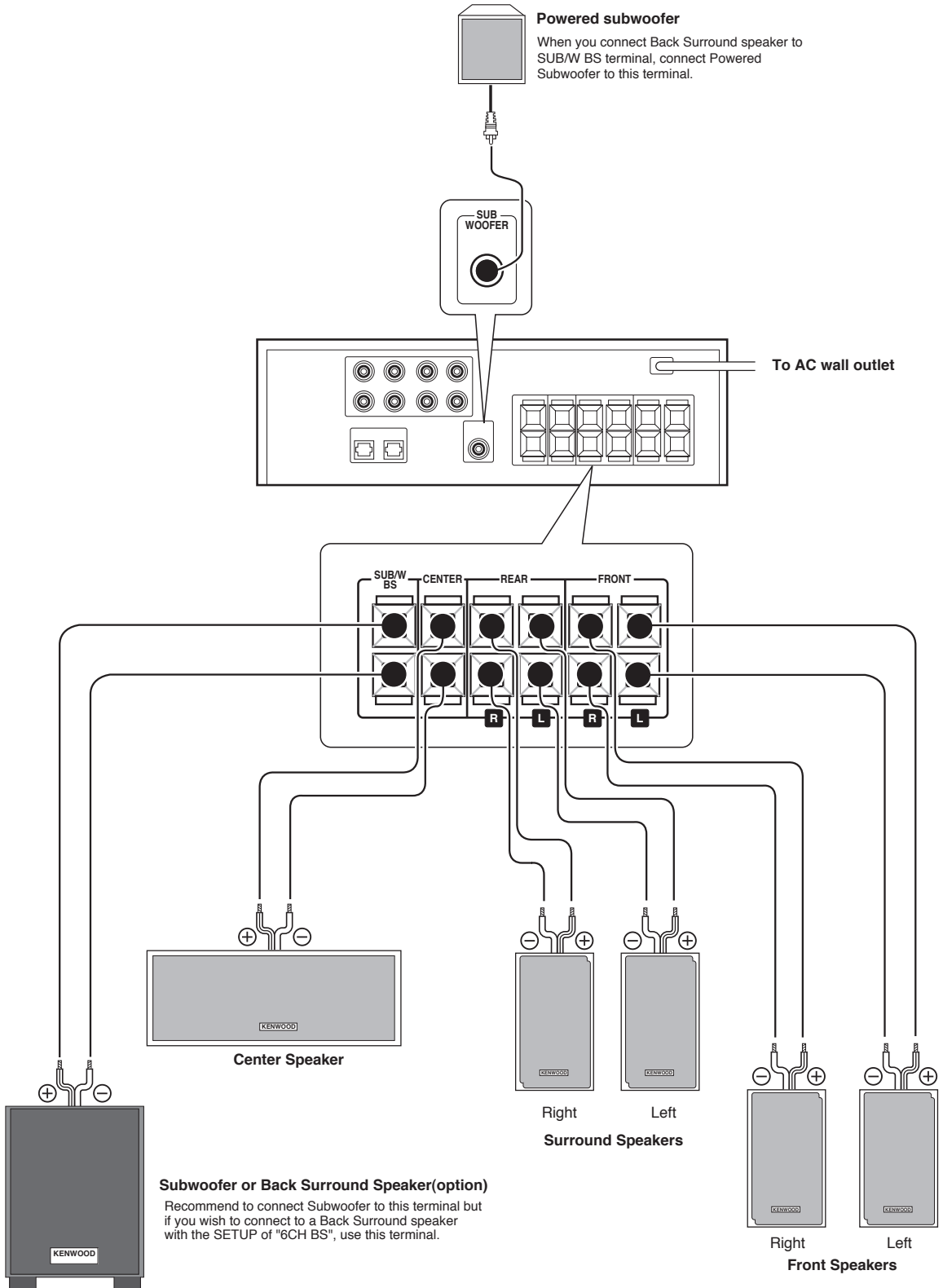

## Connecting the terminals

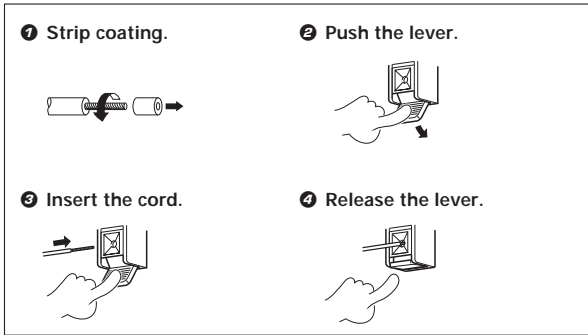

- Never short circuit the + and – speaker cords.
- If the left and right speakers are connected inversely or the speaker cords are connected with reversed polarity, the sound will be unnatural with ambiguous acoustic imaging. Be sure to connect the speakers correctly.

### Speaker impedance

After confirming the speaker impedance indications printed on the rear panel of the amplifier, connect speakers with matching impedance ratings. Using speakers with a rated impedance other than that indicated on the rear panel of the amplifier could result in malfunctions or damage to the speakers or receiver.

### Speaker placement

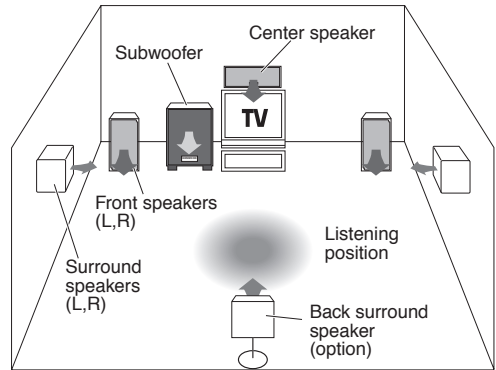

#### Front (left and right) speakers

Place at the front left and right of the listening position. Front speakers are required for all surround modes.

#### Center speaker

Place front and center. This speaker stabilizes the sound image and helps recreate sound motion. Required for surround playback.

#### Surround (left and right) speakers

Place at the direct left and right, or slightly behind, the listening position at even heights, approximately 1 meter above the ears of the listeners. These speakers recreate sound motion and atmosphere. Required for surround playback.

#### Subwoofer

Reproduces powerful deep bass sounds.

#### Back surround speaker (option)

Place the speaker directly at the rear of the listening position. The optimum position depends mainly on the room condition.

- Although the ideal surround system consists of all the speakers listed above, if you don't have a center speaker or a subwoofer, you can divide those signals between the available speakers in the speaker settings steps to obtain the best possible surround reproduction from the speakers you have available. - 15

## Connecting to the FRONT AUX jacks

The **FRONT AUX** jacks are convenient for connection of video components such as a camcorder or a video game.

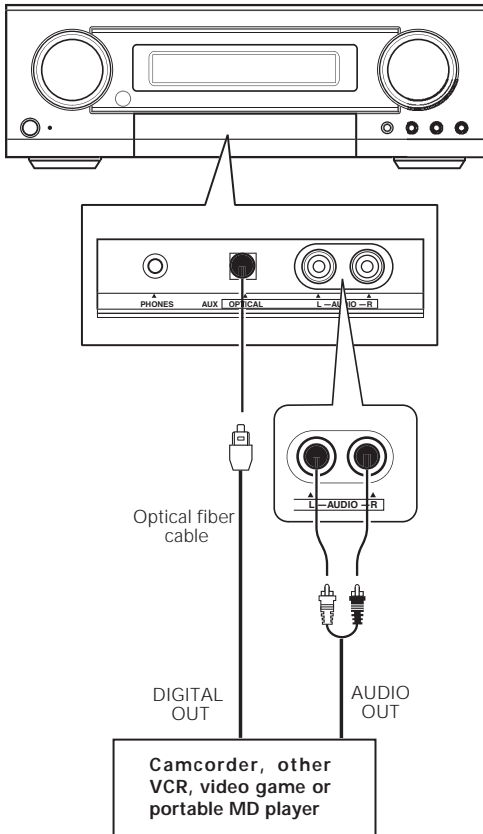

- To select the source connected to the FRONT AUX jacks select **FRONT AUX** key.

- 18

## Preparing the remote control

### Loading the batteries

① Remove the cover.

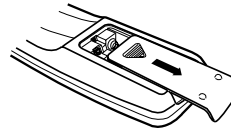

② Insert the batteries.

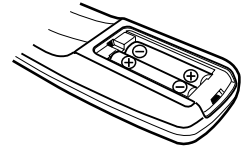

③ Close the cover.

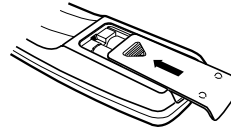

- Insert two AAA-size (R03) batteries as indicated by the polarity markings.

### Operation

When the **STANDBY** indicator is lit, the power turns ON when you press the **POWER** key on the remote control. When the power comes ON, press the key you want to operate.

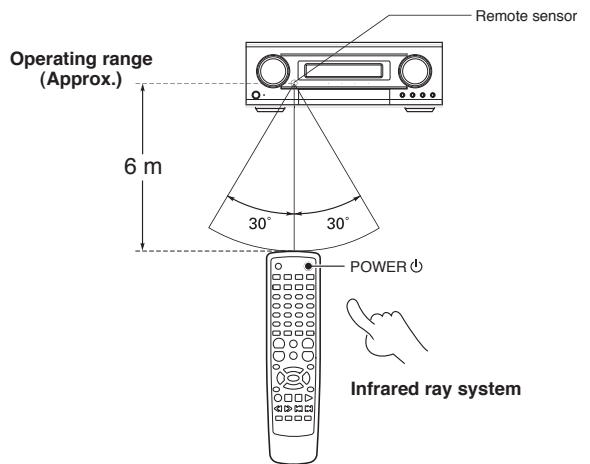

- When pressing more than one remote control key successively, press the keys securely by leaving an interval of 1 second or more between keys.

### Notes

1. The supplied batteries may have shorter lives than ordinary batteries due to use during operation checks.
2. When the remote-controllable distance gets shorter than before, replace both batteries with new ones.
3. Placing the remote sensor in direct sunlight, or in direct light from a high frequency fluorescent lamp may cause malfunction. In such a case, change the location of the system installation to prevent malfunction.

# Preparing for surround sound

## Speaker settings

To enable you to obtain optimum enjoyment from the amplifier's listening modes, make sure to complete the speaker settings (subwoofer, front, center, surround and surround back speakers) as described below.

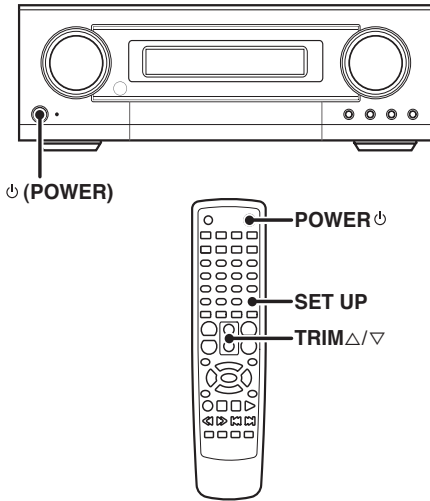

If you purchase HTB-S500 system, you may skip step 2 to 4. Original settings of this amplifier are adjusted to KSW-S500 speakers.

The original settings are

6ch AMP	: 6ch SW	Subwoofer	: SW ON
Front	: FRONT NML	Center	: CNTR NML
Surround	: SURR NML	Back surround	: BS NML
Subwoofer Re-Mix	: REMIX ON		

**1** Turn on the power to this amplifier by pressing the **⏻ (POWER)** key.

**2** Press the **SET UP** key to enter the **SET UP** mode.

Use the **TRIM**  $\Delta/\nabla$  keys to select the "SP SETUP"

- ① SP SETUP
- ② TEST TONE
- ③ DISTANCE
- ④ DIMMER
- ⑤ EXIT

**3** Press the **SET UP** key to select the **6ch AMP** setting.

The Back Surround and Subwoofer output selections are displayed as follows:

- ① **6ch SW** : SUB/W BS speaker terminal will output Subwoofer sound.
- ② **6ch BS** : SUB/W BS speaker terminal will output Back Surround sound. Subwoofer pre out will have output from SW only.
- ③ **6ch OFF** : It is not advisable to use SUB/W BS speaker terminal for this selection.

Use the **TRIM**  $\Delta/\nabla$  keys to select the speakers. Press the **SET UP** key to proceed to the next SETUP selection.

The flow of the SETUP is as follows:

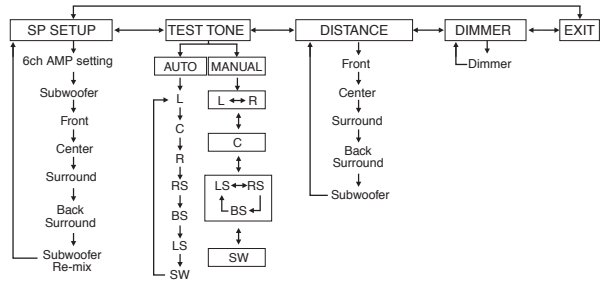

### 4 Select a speaker system.

If you have THX certified speakers, please set them to NML.

**1** Press the **SET UP** key again so that the subwoofer setting indication "SW ON" appears.

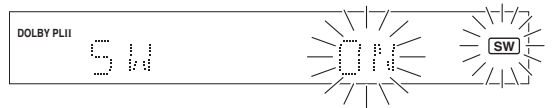

**2** Use the **TRIM**  $\Delta/\nabla$  keys to select the appropriate subwoofer setting.

- ① **SW ON** : Subwoofer setting mode to the amplifier is ON.
- ② **SW OFF** : Subwoofer setting mode to the amplifier is OFF.

• When the setting "SW OFF" is selected using the **SET UP** key, the front speakers are automatically set to "FRONT LRG" and the procedure skips to step 6. Before step 6, press the **SET UP** key to accept the setting.

**3** Press the **SET UP** key to accept the setting.

• The front speakers setting indication "FRONT" appears.

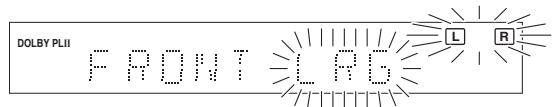

**4** Use the **TRIM**  $\Delta/\nabla$  keys to select the appropriate front speakers setting.

- ① **FRONT LRG** : Large front speakers are connected to the amplifier.
- ② **FRONT NML** : Average size front speakers are connected to the amplifier.

• For "FRONT LRG" and "SW ON" selection, no sound will be heard from subwoofer speaker even when it is set to on. However, if you select "REMIX ON" in step 12 when subwoofer is selected, you will be able to hear sound from the subwoofer.

**5** Press the **SET UP** key to accept the setting.

• The center speaker setting indication "CNTR" appears.

- 6 Use the TRIM $\Delta$ / $\nabla$  keys to select the appropriate center speaker setting.

If you selected "LRG" as the front speakers setting,

- 1 CNTR NML : An average size center speaker is connected to the amplifier.
- 2 CNTR LRG : A large center speaker is connected to the amplifier.
- 3 CNTR OFF : Center speaker setting mode to the amplifier is OFF.

If you selected "NML" as the front speakers setting,

- 1 CNTR ON : Center speaker setting mode to the receiver is ON.
- 2 CNTR OFF : Center speaker setting mode to the receiver is OFF.

- 7 Press the SET UP key again to accept the setting.  
 • The surround speaker indication "SURR" appears.

- 8 Use the TRIM $\Delta$ / $\nabla$  keys to select the appropriate surround speaker setting.

If you selected "LRG" as the center speaker setting,

- 1 SURR NML : Average size surround speakers are connected to the amplifier.
- 2 SURR LRG : Large surround speakers are connected to the amplifier.
- 3 SURR OFF : Surround speaker setting mode to the amplifier is OFF.

If you selected other than "LRG" as the center speaker setting,

- 1 SURR ON : Surround speaker setting mode to the amplifier is ON.
- 2 SURR OFF : Surround speaker setting mode to the amplifier is OFF.

• When the setting "SURR OFF" is selected, by pressing the SET UP key in step 9 the procedure skips to step 12. But if "SURR OFF" is selected, press the SET UP key to skip to step 5.

- 9 Press the SET UP key again to accept the setting.  
 • The back surround speaker setting indication "BS" appears.

- 10 Use the TRIM $\Delta$ / $\nabla$  keys to select appropriate surround back speaker setting.

If you selected "LRG" as the surround speaker setting,

- 1 BS NML : Average size back surround speaker is connected to the amplifier.
- 2 BS LRG : Large back surround speaker is connected to the amplifier.
- 3 BS OFF : Back surround speaker setting mode to the amplifier is OFF.

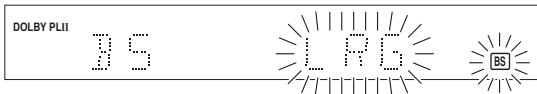

If you selected "NML" as the surround speaker setting,

- 1 BS NML : Back surround speaker setting mode to the amplifier is ON.
- 2 BS OFF : Back surround speaker setting mode to the amplifier is OFF.

- 11 Press the SET UP key again to accept the setting.  
 • The subwoofer remix setting indication "REMIX" appears.  
 • If subwoofer is turned off, subwoofer re-mix setting is not visible.

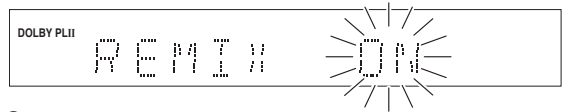

- 12 Use the TRIM $\Delta$ / $\nabla$  keys to select the appropriate subwoofer re-mix setting.

- 1 REMIX ON : Subwoofer re-mix setting mode to the amplifier is ON.
- 2 REMIX OFF : Subwoofer re-mix setting mode to the amplifier is OFF.

When "REMIX ON" is selected, bass sound of other channel will be added into Subwoofer or bass sound of Subwoofer will be added into other channel to increase deep bass performance.

- 13 Press the SET UP key again to return to the 2.  
 • The receiver enters the speaker volume level adjustment mode.  
 • In steps 2 and 4, indications appear only for the selected channels of the speakers that require adjusting.

### 5 Adjust the speaker volume level.

From your usual listening position, adjust the volume levels. The volume levels from each speaker should be the same.

- 1 Press the SET UP key and then use the TRIM $\Delta$ / $\nabla$  keys to select TEST TONE.

- 2 Press the SET UP key for the following displays:

The selection of AUTO or MANUAL is done by the TRIM $\Delta$ / $\nabla$  keys.

- 1 AUTO
- 2 MANUAL

- 3 Press the SET UP key again to begin TEST TONE.

Use the TRIM $\Delta$ / $\nabla$  keys to adjust the volume level of the test tone output from the speaker channel to be adjusted.

For AUTO selection, the first test tone is heard from the front left speaker for 3 seconds. The next test tone is heard from the speakers in the following sequence for 3 seconds each.

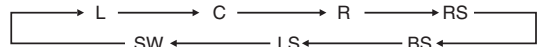

The channel indication blinks while the test tone is being output.



- If you change the volume level settings for the speakers while listening to music, the settings referred to on this page are also changed.
- If the speaker setting selects are OFF, the speaker level settings are reset.

For "MANUAL" selection, press the FRONT, CENTER, REAR or SW keys to select the speaker channel and then adjust the volume level by pressing TRIM $\Delta$ / $\nabla$  keys.



- Press the **FRONT** key each time to select Front L or Front R channel.
- Press the **CENTER** or **SW** key to select center or subwoofer channel.
- Press the **REAR** key to select surround channel.  
And use the **REAR** key for the following displays.

- ① **LS** : Surround L channel.
- ② **BS** : Back surround channel.
- ③ **RS** : Surround R channel.

- ④ Press the **SET UP** key again.
  - The test tone is turned off and return to the main setup displays.

## 5 Input the distance to the speakers.

- ① Measure the distance from the listening position to each of the speakers.

Jot down the distance to each of the speakers.

Distance to Front left speaker (L) : \_\_\_ meters  
Distance to Center speaker (C) : \_\_\_ meters  
Distance to Front right speaker (R) : \_\_\_ meters  
Distance to Surround right (RS) : \_\_\_ meters  
Distance to Back Surround (BS) : \_\_\_ meters  
Distance to Surround left (LS) : \_\_\_ meters  
Distance to Subwoofer (SW) : \_\_\_ meters

- ② Press the **TRIM**  $\Delta/\nabla$  keys to select the "DISTANCE" on setup displays and press the **SETUP** key again.

- ③ Use the **SET UP** key to select the speakers and the **TRIM**  $\Delta/\nabla$  keys to adjust the distance to the front speakers.

The speaker indicator to be adjusted blinks.

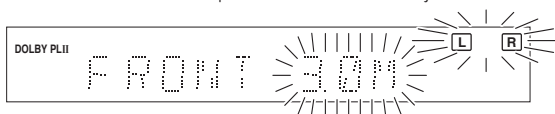

- The allowable setting range is 0.3 to 9.0 m, adjustable in 0.3 m increments.

- ④ Repeat steps ③ to input the distance for each of the speakers.
- ⑤ Press the **SET UP** key again to return to main setup displays.
  - The speakers you have selected should appear on the display.  
Confirm that all the speakers have been correctly selected.

# Normal playback

## Preparing for playback

Some preparatory steps are needed before starting playback.

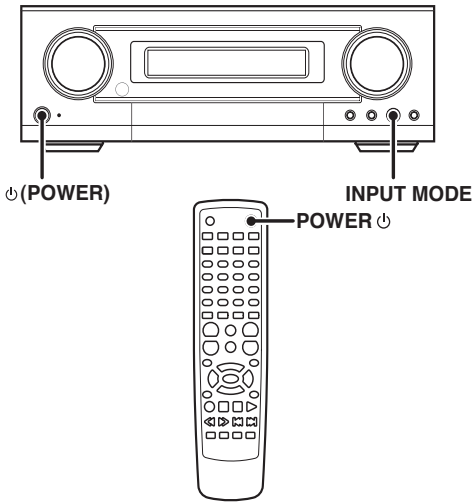

### Turning on the amplifier

- 1 Turn on the power to the related components.
- 2 Turn on the power to this amplifier by pressing the **POWER** key.

### Selecting the input mode

If you have selected a component connected to the **DVD/CD**, **VIDEO 2** or **FRONT AUX** jacks, make sure that the input mode setting is correct for the type of audio signal to be used. 

## Listening to a source component

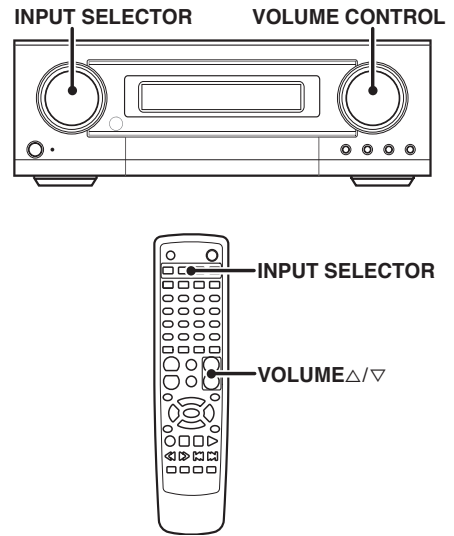

- 1 Use the **INPUT SELECTOR** knob (or **INPUT SELECTOR** keys) and **AV AUX** key to select the source you want to listen to.

Selecting a source using each key.

- 1 "DVD/CD"
- 2 "VIDEO 1"
- 3 "VIDEO 2"
- 4 "FRONT AUX"

- 2 Start playback from the selected source.

- 3 Use the **VOLUME CONTROL** knob (or **VOLUME CONTROL**  $\Delta/\nabla$  keys) to adjust the volume.

## Adjusting the sound

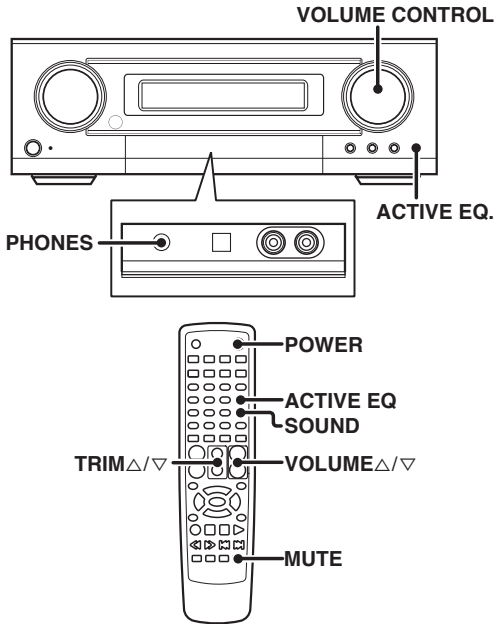

### Adjusting the TONE

You can adjust the sound quality when the receiver is in the PCM stereo mode, analog stereo mode.

- 1 Press the SOUND key to select the SOUND mode.

When input signal is Dolby Digital and STEREO

- ① T.SURR ON or OFF : SRS TruSurround
- ② TONE : Tone
- ③ NIGHT ON or OFF : Midnight mode

When input signal is except STEREO

TONE : Tone

- For other input signal, some of mode will not be displayed.

- 2 Use the TRIM Δ/∇ keys to select TONE and then press SOUND key.

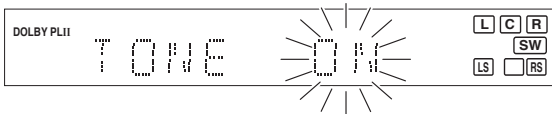

- 3 When in TONE ON selection, press the SOUND key for the following displays.

BASS : Select this to adjust the low frequency range.  
TREBLE : Select this to adjust the high frequency range.

- 4 Use the TRIM Δ/∇ keys to adjust the sound quality.

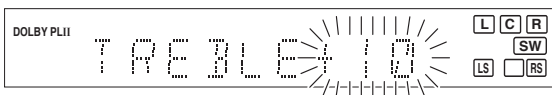

- The bass and treble levels are adjustable from -10 to +10 in 2 step increments.
- The adjustment item is displayed for approximately 20 seconds.

### Muting the sound

The MUTE key lets you mute the sound of the speakers.

Press the MUTE key.

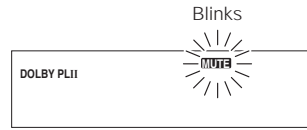

To cancel

Press the MUTE key again so that the "MUTE" indicator goes off.

- MUTE ON can also be deactivated by turning the pressing VOLUME CONTROL knob (or VOLUME Δ/∇ keys).

### ACTIVE EQ mode

You can enjoy a more impressive sound effect when ACTIVE EQ is turned ON during Dolby Digital and DTS playback and, when in PCM and analog stereo mode.

Press the ACTIVE EQ key for the following selections;

- ① EQ CINEMA : Effective when watching a movie. (The ACTIVE EQ. indicator lights up.)
- ② EQ MUSIC : Effective when listening to music. (The ACTIVE EQ. indicator lights up.)
- ③ EQ OFF : The ACTIVE EQ function is turned OFF. (The ACTIVE EQ. indicator goes off.)

- ACTIVE EQ function will not be available when during recording or DTS-ES MATRIX is ON, and during 96kHz LPCM playback.

### Listening with headphones

- 1 Connect headphones to the PHONES jack.



- Headphones with a stereo mini plug can be connected.
- The sounds from all speakers are cut off.

- 2 Use the VOLUME CONTROL knob (or VOLUME Δ/∇ keys) to adjust the volume.

# Recording

---

## Recording audio (analog sources)

---

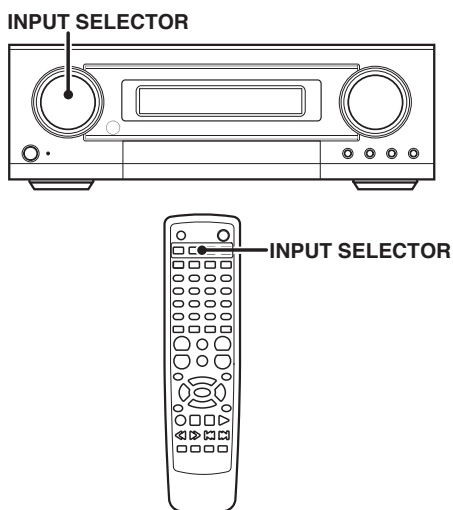

---

### Recording a music source

❶ Use the INPUT SELECTOR knob (or INPUT SELECTOR keys) to select the source (other than "VIDEO 1") you want to record.

- Connect analogue audio outputs to this Amplifier. → 10

❷ Start playback, then start recording.

# Ambience effects

This receiver is equipped with listening modes that allow you to enjoy an enhanced sonic ambience with a variety of video sources.

In order to obtain the optimum effect from the surround modes, make sure to input the proper speaker settings beforehand. → [15]

## Surround modes

### Dolby Digital

The Dolby Digital surround format lets you enjoy up to 5.1 channels of digital surround sound from Dolby Digital program sources (such as Laserdisc or DVD software marked ). Compared with previous Dolby surround, Dolby Digital provides even better sound quality, greater spatial accuracy, and improved dynamic range.

Although a full set of speakers (front left, right, and center, surround left and right, and a subwoofer) is required for true 5.1 channel Dolby Digital surround sound, this receiver lets you enjoy Dolby Digital (and Dolby Surround) program sources, even if you connect only the front speakers.

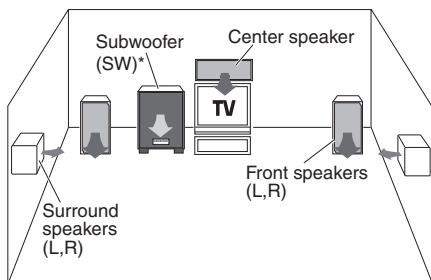

\*Optional in this mode.

Manufactured under license from Dolby Laboratories. "Dolby", "Pro Logic", "Surround EX" and the double-D symbol are trademarks of Dolby Laboratories.

"DTS", "DTS-ES Extended Surround" and "Neo:6" are trademarks of Digital Theater Systems, Inc.



Note

\*LFE = Low Frequency Effects. This channel delivers separate non-directional bass signals to the subwoofer for more dynamic deep bass sound effects.

### DTS

The DTS multi-channel audio format is available on CD, LD and DVD software. DTS is strictly digital format and cannot be decoded inside most CD, LD or DVD players. For this reason, if you attempt to listen to DTS encoded software through the analog output of your new CD, LD or DVD player, you will experience digital noise in most cases. This noise can be quite loud if the analog output is connected directly to a high power amplification system. Proper measures for playing the digital output as described below should be taken to avoid this situation. To enjoy DTS Digital Surround playback, an external 5.1 channel DTS Digital Surround decoder system or an amplifier with a built-in DTS Digital Surround decoder must be connected to the digital output (S/P DIF, AES/EBU or TosLink) of a CD, LD or DVD player. All models are incorporated with the DTS decoder.

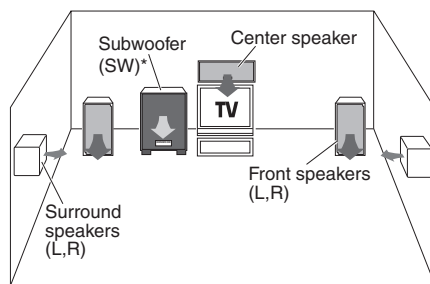

\*Optional in this mode.

Note

\*LFE = Low Frequency Effects. This channel delivers separate non-directional bass signals to the subwoofer for more dynamic deep bass sound effects.

DTS has a .1 or LFE channel.

The indication "LFE" appears in the display when a signal is being input for this channel.

### Dolby PRO LOGIC II

Dolby Pro Logic II was designed specifically to provide a new sense of spatiality, directionality and articulation of sounds from Dolby Surround encoded sources (such as video and Laserdisc software marked ). This is achieved with an intelligent, built-in feedback logic design, a matrix surround decoding and the decoding of stereo, full bandwidth surround outputs. The PRO LOGIC II modes programmed into this receiver are "MOVIE", "MUSIC" and "PRO LOGIC". The "MOVIE" mode of the PRO LOGIC II has preset characteristics to produce a calibrated.

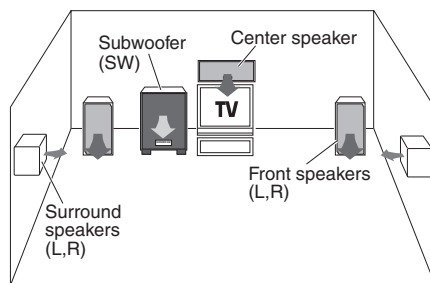

**DSP mode**

The DSP mode lets you add the atmosphere of a live concert or hall to almost any type of program source. These modes are particularly effective when used with stereo program sources, like CD, television, and FM radio. You might enjoy trying the ARENA, JAZZ CLUB, THEATER, STADIUM or DISCO mode the next time you watch a concert or sporting event!

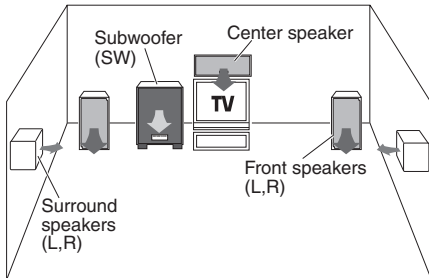

**What's DSP?**

DSP stands for Digital Signal Processor. The way a sound is heard in an actual environment depends on a variety of different factors. One of the most important is reverberation (the act of decaying elements of sound echoing in various places). The DSP modes produce the feeling of presence by using the DSP to create reverberation, without spoiling the sound quality of the original signal.

**Dolby Digital EX**

Dolby Digital EX is an extension of Dolby Digital technology, Dolby Digital EX creates six full-bandwidth output channels from 6.1-channel sources. This is done using a matrix decoder that derives three surround channels from the two in the original recording. This is achieved by using three different surround signals, Left Surround, Right Surround, and Back Surround, each driving its own array of speakers. Think of it as adding a center channel for the rear speakers, which give more diffuse and natural surround effect, even if you wanted the ability to completely encircle the audience with sound, positioning sound effects exactly where they would be heard in real life. For best results, Dolby Digital EX should be used with movie soundtracks recorded with Dolby Digital Surround EX which contain a digital flag that will automatically activate this feature. However, for titles released prior to late 2001, this feature has to be activated manually.

Although a full set of speakers (front left and right, center, surround left and right, back surround and a subwoofer) are required for true 6.1 channel Dolby Digital surround EX sound, this receiver lets you enjoy Dolby Digital (and Dolby Surround) program sources, even if you connect only the front speakers.

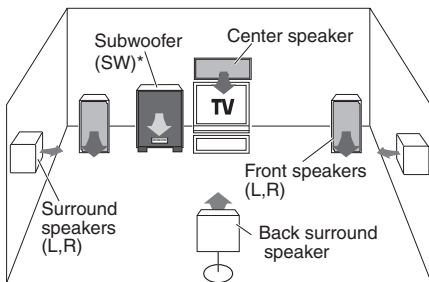

\*Optional in this mode.

Although only Dolby Digital soundtracks incorporate a separate low frequency channel, connecting a subwoofer will also improve deep bass performance in the other surround modes.

The indication "LFE" appears in the display when a signal is being input for this channel.

**DTS-ES**

DTS-ES (Digital Theater System-Extended Surround) presents 6.1 channels surround system with additional Back Surround channel which evolved from the conventional 5.1 channels surround system. DTS-ES format that was recorded in DVD, CD or LD comprises of two modes. DTS-ES Discrete 6.1 produce the discrete back surround which is completely independent and DTS-ES Matrix 6.1 produces the back surround which synthesised within the left and right surround channels using matrix technology. DTS-ES has perfect compatibility with the conventional 5.1 channels surround system. 6.1 channels surround with an additional back surround presents a more natural presence and surround effects by increasing the impression of the sound image from back. Programs which are recorded using DTS-ES technology consist of information flags which will be able to control the Discrete and Matrix mode. Thus, it can automatically select the best matched mode.

**Neo:6**

Neo:6 is a new technology which was developed by DTS. It can produce high grade 6 channels surround with an astonishing fidelity from 2 channels content. Neo:6 has 2 mode, "CINEMA" mode is for movie playback and "MUSIC" mode is for music playback.

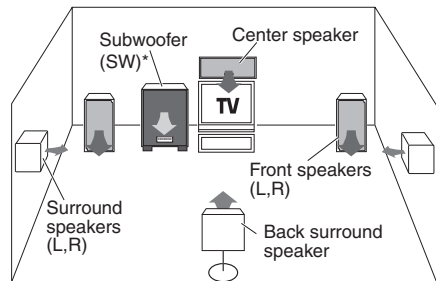

DTS has a .1 or **LFE** channel. The indication "LFE" appears in the display when a signal is being input for this channel.



\*Optional in this mode.

## Surround play

The DTS compatible models can reproduce a CD, DVD, or LD carrying the DTS mark.

DOLBY DIGITAL can be used when playing DVD or LD software bearing the  mark and DOLBY DIGITAL format digital broadcasts (etc.). DOLBY PRO LOGIC can be used when playing video, DVD, or LD software bearing the  mark.

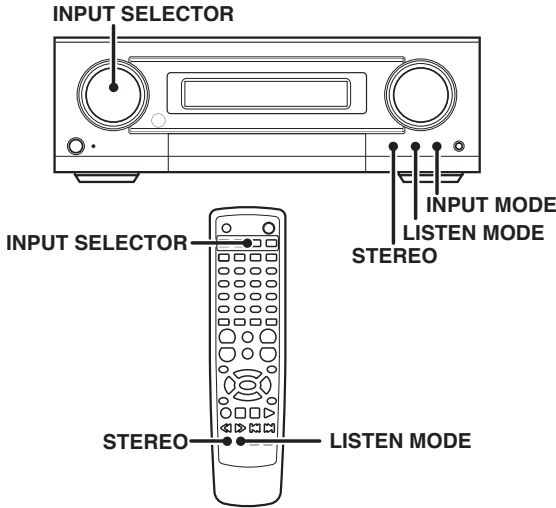

### Preparations

- Turn ON related components.
- Complete "Preparing for surround sound" (speaker settings). → [15]
- Use the **INPUT SELECTOR** knob (or **INPUT SELECTOR** keys) to select the component you wish to play back with surround sound.
- Use the **INPUT MODE** key to select the input mode (analog or digital) for the source you wish to play back. → [9]
- Noise will be produced when a DTS source is played by selecting the analog input.

### 1 Start playing the video software.

### 2 Use the LISTEN MODE key to select the listening mode.

The listening mode settings are stored separately for each input. If the input mode is set to full auto the receiver selects the optimal listening mode automatically based on the type of input signal and the speaker settings.

Each press of the LISTEN MODE key switches the setting as listed below.

The listening mode settings are different depending on the type of input signal.

#### Dolby Digital Surround EX compliant disc :

Dolby Digital Surround EX compliant disc contains the identification signals. When you choose **FULL AUTO** during "Input mode settings" (→ [9]), this amplifier detects the identification signals and change the LISTEN mode to the **DOLBY D EX** (Dolby Digital Surround EX mode) automatically.

But sometimes we find some discs which is Dolby Digital Surround EX compliant disc but it does not contain the identification signals. If you find the notice like "Surround EX" on the label of disc or package, you can choose **DOLBY D EX** then you can enjoy Dolby Digital Surround EX sound.

### When the DOLBY DIGITAL EX or DOLBY DIGITAL signal is input :

(The DOLBY D or DOLBY PLII, indicator lights up.)

- ① **DOLBY D** : DOLBY DIGITAL EX surround. (The DOLBY D EX indicator lights up.) When DOLBY DIGITAL signal is input or Back surround speaker is OFF, this menu will not be displayed.
- ② **DOLBY D** : DOLBY DIGITAL surround. (The DOLBY D indicator lights up.)
- ③ **MOVIE** : PRO LOGIC II surround MOVIE mode. (The DOLBY PLII indicator lights up.)
- ④ **PRO LOGIC** : PRO LOGIC II surround PRO LOGIC mode. (The DOLBY PL indicator lights up.)
- ⑤ **STEREO** : Normal stereo playback. When you select DOLBY DIGITAL "DOLBY D" will be displayed.

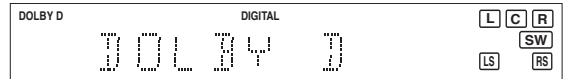

### When the DTS or DTS-ES (matrix or discrete) signal is input :

- ① **DTS** : DTS 5.1ch surround mode. (DTS indicator lights up.)
- ② **MTRX 6.1** : DTS 6.1ch MATRIX surround mode. (DTS-ES and MATRIX 6.1 indicators light up.)
- ③ **DSCRT 6.1** : DTS 6.1ch DISCRETE surround mode. (DTS-ES and DISCRETE 6.1 indicators light up.)
- ④ **STEREO** : Normal stereo playback.

### When the analog signal or the digital signal (except for DOLBY DIGITAL or DTS signal) is input :

- ① **MOVIE** : PRO LOGIC II surround MOVIE mode. (The DOLBY PL II indicator lights up.)
- ② **MUSIC** : PRO LOGIC II surround MUSIC mode. (The DOLBY PL indicator lights up.)
- ③ **PRO LOGIC** : PRO LOGIC II surround PRO LOGIC mode. (The DOLBY PL indicator lights up.)
- ④ **CINEMA** : NEO:6 surround. (The NEO:6 indicator lights up.)
- ⑤ **MUSIC** : NEO:6 surround. (The NEO:6 indicator lights up.)
- ⑥ **ARENA** : DSP surround ARENA mode. (The DSP indicator lights up.)
- ⑦ **JAZZ CLUB** : DSP surround JAZZ CLUB mode. (The DSP indicator lights up.)
- ⑧ **STADIUM** : DSP surround STADIUM mode. (The DSP indicator lights up.)
- ⑨ **DISCO** : DSP surround DISCO mode. (The DSP indicator lights up.)
- ⑩ **THEATER** : DSP surround THEATER mode. (The DSP indicator lights up.)
- ⑪ **STEREO** : Normal stereo playback.

• Dolby Digital or DTS signal having more channels than the maximum number of playback channels available using the receiver's current settings is input, downmixing is performed to match the number of available speaker channels.

• The DSP mode selection is displayed for approximately 3 seconds.

### 3 Adjust the volume.

**To change to STEREO mode.**

When you press the **STEREO** key, the LISTEN mode will be switched to the STEREO mode.

During above STEREO mode, if you press **STEREO** key again, the STEREO mode will be switched back to the LISTEN mode.

- If you switch to the STEREO mode using **STEREO** key, the DSP mode will be turned off automatically.
- If you turn off and on the POWER, setting of the LISTEN mode will not be loosed.

Notes

- Depending on the type of the signal or speaker setting, some listening modes cannot be selected.
- When playback is started, the sound may be cut or interrupted before the input source is confirmed as Dolby Digital.

**SRS TruSurround play**

When STEREO mode has been chosen in LISTEN MODE and input signal is STEREO, you can enjoy surround effect by SRS TruSurround.

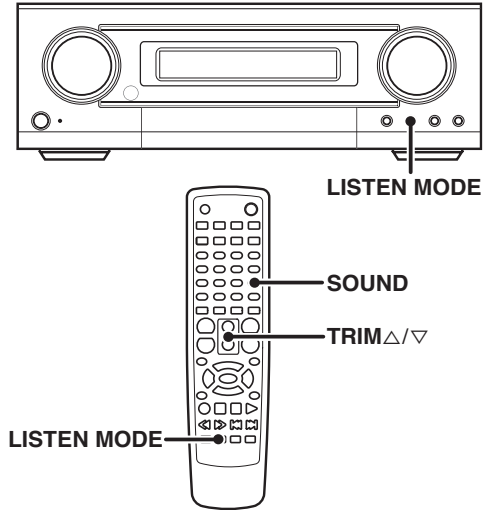

**1** Select STEREO mode using LISTEN MODE key.



**2** Press the SOUND key twice.

**3** Use the TRIM Δ/∇ keys to select ON or OFF.

- ① T.SURR ON : SRS TruSurround ON.
- ② T.SURR OFF : SRS TruSurround OFF.

**4** Press the SOUND key to return to the input indication.

- The adjustment item is displayed for approximately 20 seconds.



# Convenient functions

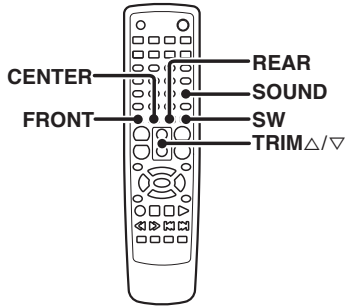

## Adjustment of each channels' level

You can adjust each channel's level during listening music.

- 1 Press the **FRONT** key to adjust FRONT L channel's level.



- 2 Use the **TRIM**Δ/∇ keys to adjust the sound level.
- 3 Press the **FRONT** key to adjust FRONT R channel's level.
- 4 Use the **TRIM**Δ/∇ keys to adjust the sound level.
- 5 Press the **FRONT** key to return to the input indication.

- The sound level is adjustable from -10 dB to +10dB in 1dB step increments.
- The adjustment item is displayed for approximately 20 seconds.
- Use the **CENTER** or **SW** key to adjust sound level of center or subwoofer channel.
- Use the **REAR** key to adjust sound level of surround channel. And use the **REAR** key for the following displays.

- 1 **LS** : Surround L channel.
- 2 **BS** : Surround back channel.
- 3 **RS** : Surround R channel.

## Midnight mode (Dolby Digital mode only)

When watching movies at night, you might not be able to raise the volume as loud as normal. Midnight mode compresses the dynamic range of previously specified heavy sound passage of the Dolby Digital sound track (like scenes with sudden increases in volume) to minimize the difference in volume between the scenes with heavy sound passage and scenes with normal sound passage. This makes it easy to hear all of the sound track, even when listening at low volumes.

- 1 Press the **SOUND** key to enter the **SOUND** mode.
  - This can be selected only if DVD/CD, VIDEO 2 or FRONT AUX is selected as the source and the listen mode is set to "DOLBY DIGITAL."
- 2 Use the **TRIM**Δ/∇ keys to select the "NIGHT" and then press the **SOUND** key.
- 3 Use the **TRIM**Δ/∇ keys to select ON or OFF.
  - 1 **NIGHT ON** : Midnight mode ON.
  - 2 **NIGHT OFF** : Midnight mode OFF.
- 4 Press the **SOUND** key to return to the input indication.

- The adjustment item is displayed for approximately 20 seconds.
- Some Dolby Digital software may not be compatible with the Midnight mode.

## Display dimmer adjustment

The dimmer function lets you select the brightness of the amplifier's display. You might find this useful if you darken your room to watch movies or listen to music.

- 1 Press the **SET UP** key to enter the **SETUP** mode.
- 2 Use the **TRIM**Δ/∇ keys to select the "DIMMER".
- 3 Press the **SET UP** key again so that the dimmer setting indication appears. Select the brightness level you find most pleasing using **TRIM** (Δ/∇) keys.
  - 1 **DIMMER H** : Bright
  - 2 **DIMMER L** : Dark
- 4 Press the **SET UP** key to return to the "DIMMER".
- 5 Use the **TRIM**Δ/∇ keys to select the "EXIT".
- 6 Press the **SET UP** key to return to the input indication.

## Sleep timer (SLEEP)

Set the number of minutes after which the unit to be turned OFF.

Connect the related component under reference to "Connecting audio components".

Press the **SLEEP** key to select the time.

- Each press increases the timer period by 10 minutes. The sleep timer can be setup to 90 minutes.

10 → 20 → 30 → .... → 80 → 90 → OFF → 10 → 20 → ....

The sleep timer indicator will be lit.

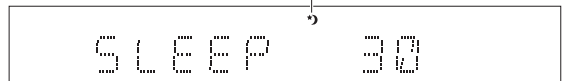

- The system has been setup so that the display is dimmed automatically while the sleep timer is activated.
- Press the **SLEEP** key while the sleep timer is activated to check the remaining time.

### To cancel

Turn the amplifier OFF or press the **SLEEP** key until the sleep time is cancelled.

## 96kHz LPCM playback

The amplifier is compatible with the 96kHz LPCM playback. To play a 96kHz DVD, set the listen mode to "STEREO".

- In **FULL AUTO** input mode the listen mode will automatically be STEREO.
- When in **D MANUAL** input mode (listen mode is not STEREO), "96kHz LPCM" will appear in the display and no sound can be heard from the speakers. Press the **LISTEN MODE** or **STEREO** key (the listen mode changes to the STEREO mode) to output sound from the speakers.

# Basic remote control operations for other components

The remote control supplied with this amplifier is also capable of controlling components from a variety of manufacturers once you register the appropriate setup codes into the remote control unit.

## Low battery warning

Replace all two batteries with new ones when you notice a shortening of the distance from which the remote control will operate. The remote control is designed to retain setup codes in memory while you change batteries.

## Registering setup codes for other components

Refer to below list about the components which can be registered to INPUT SELECTOR keys of the remote control. You can register to the ○ marked INPUT SELECTOR keys of the remote control.

INPUT SELECTOR keys	DVD/CD	VIDEO1	VIDEO2	TV
VIDEO		○		
TV				○
Satellite			○	
Cable			○	
DVD player	○			
CD player	○			

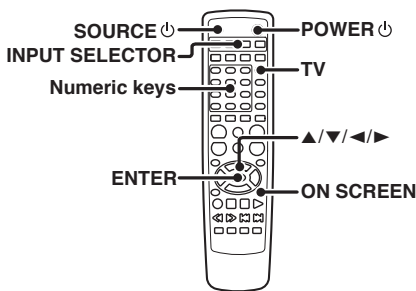

### 1 Find the setup code of the component to be registered.

- Refer to the setup code lists to find the setup code for the component to be registered. → [28]
- Example: To register a DVD made by KENWOOD, you would enter "005".

Input	Component	Maker	Code	Key
(DVD)	DVD player	KENWOOD	005	DVD/CD

### 2 Registering components for the remote control.

- During press and hold the ENTER key, press one of the INPUT SELECTOR key or TV key which you want to register.
  - LED will blink twice as confirmation.
- Press the Numeric keys to enter the three-digit setup code.
  - LED will blink once as confirmation.

- Press the registered INPUT SELECTOR key and then press the SOURCE (power icon) key to check that the component you want to control turns on or press the TV (power icon) key to check that the TV turns on.

If the component does not react, and there is more than one setup code, enter another setup code and try again.

- If the component is already on, pressing the SOURCE (power icon) key will turn it off.

### 4 Repeat steps 2 to 3 to register additional components until

## Checking the codes .

If you want to know which number was set.

- After registering the setup code, press and hold the ENTER key and then press the INPUT SELECTOR key.
  - LED will blink twice as confirmation.
- Press the ON SCREEN key.
  - LED will blink according to first, second and third digit for the current setup code.
  - In case of digit 0, the LED will blink ten times.
  - Example : If the registered SETUP code is "028", the LED will blink ten times, two times and eight times.
  - If the ON SCREEN key is not pressed within ten second, this function will be cancelled.

## Note

Although each setup code is designed to work with a number of different models, certain codes may not work with some models. (Also, certain codes may only operate some of the functions available on a given model.)

## If no response after registering setup codes.

- During press and hold the ENTER key, press any of the INPUT SELECTOR keys or TV key which you want to register.
  - LED will blink twice as confirmation.
- Press the ▲ key until the component you want to control turns on.
- Press the ENTER key.
  - If you press the ▲ key after turn on the component you want to control, press ▼ key to return to previous step.

## Operating other components

This operation lets you operate the registered components.

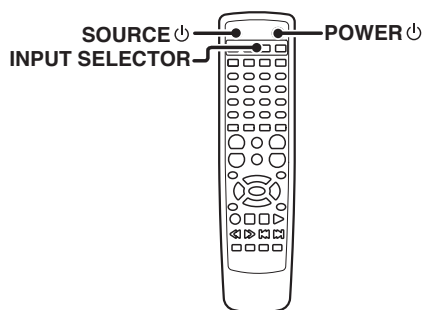

**1** Use the **INPUT SELECTOR** keys to select the component you desire.

- Pressing the **INPUT SELECTOR** keys also changes the input selector on the amplifier.

**2** Press the **SOURCE** ⏻ key.

**3** Press the operation keys you desire.

— [32] — [33]

The remote control mode remains at the selected input. If you wish to operate another component, repeat step **2** or **3**.

## Setup code chart

### TV setup codes

Maker	Setup codes
AOC	000, 001
ADMIRAL	031, 041
AIKO	014
AKAI	001
ALARON	026
AMBASSADOR	024
AMERICA ACTION	027
AMPRO	043
ANAM	027, 086, 087, 088
AUDIOVOX	014, 027, 030, 034
BAYSONIC	027
BELCOR	000
BELL&HOWELL	001, 016, 019
BRADFORD	027
BROCKWOOD	000
BROKSONIC	028, 031
CANDLE	001, 011
CARNIVAL	001
CARVER	010
CELEBRITY	050, 089
CINERAL	014, 030
CITIZEN	001, 006, 011, 012, 014
CONCERTO	011
CONTEC	027
CRAIG	027, 082
CROSLEY	010
CROWN	006, 027
CURTIS MATHES	001, 006, 007, 008, 010, 011, 012, 016, 019, 022, 030, 032, 038, 040, 041
CXC	027
DAEWOO	000, 006, 014, 030, 034, 035
DAYTRON	000
DENON	016
DUMONT	000, 002
DWIN	036, 044
ELECTROBAND	050, 089
EMERSON	000, 006, 019, 024, 025, 026, 027, 028, 029, 031, 034, 035
ENVISION	001
FISHER	019
FUJITSU	026
FUNAI	023, 026, 027
FUTURETECH	027, 083
GE	004, 007, 008, 025, 029, 030, 038, 040, 041
GIBRALTER	000, 001, 002
GOLDSTAR	000, 001, 011, 025
GRADIENTE	009, 011
GRUNPY	026, 027
HALLMARK	025
HARLEY DAVIDSON	026
HARMAN/KARDON	010
HAVARD	027
HITACHI	011, 016, 018
INFINITY	010
INTEQ	002
JBL	010
JCB	050, 089
JVC	009, 085

Maker	Setup codes
KEC	027
KTV	001, 006, 027
KENWOOD	000, 001, 016
LG	011
LOGIK	001, 016
LUXMAN	011
LXI	007, 010, 019, 020, 025
MAGATRON	016, 025
MAGNAVOX	001, 010, 026
MAJESTIC	001, 016
MARANTZ	001, 010
MATSUSHITA	042
MEMOREX	011, 017, 019, 025, 031, 042
MGA	000, 001, 017, 025
MIDLAND	002, 006, 007, 008, 035
MINUTZ	004
MITSUBISHI	000, 017, 025, 041
MOTOROLA	041
MTC	000, 001, 011, 012
MULTITECH	027
NAD	020, 022, 025
NEC	000, 001, 011
NTC	014
NIKKO	001, 014, 025
ONWA	027
OPTIMUS	019, 022, 042
OPTONICA	021, 041
ORION	026, 028, 031
PANASONIC	008, 042, 081
PENNEY	000, 001, 004, 006, 007, 008, 011, 012, 020, 025, 040
PILCO	000, 001, 010, 016, 031
PHILIPS	010
PILOT	000, 001, 006
PIONEER	022
PORTLAND	000, 006, 014
PRISM	003, 008
PROSCAN	007
PROTON	025, 032
PULSAR	000, 002, 083
QUASAR	008, 021, 042
RCA	000, 007, 008, 013, 037, 038, 039, 040, 041
RADIO SHACK	000, 001, 006, 007, 011, 019, 021, 025, 027
REALISTIC	000, 001, 006, 011, 019, 021, 025, 027
RUNCO	001, 002, 033
SAMPO	001, 006
SAMSUNG	000, 001, 011, 012, 025, 084
SAMSUX	006
SANSEI	030
SANSUI	031
SANYO	019
SCIMITSU	000
SCOTCH	025
SCOTT	000, 025, 026, 027, 028
SEARS	007, 010, 011, 019, 020, 023, 025, 026
SEMIVOX	027
SEMP	020
SHARP	006, 021, 041
SHOGUN	000

**TV setup codes**

Maker	Setup codes
SIGNATURE	001, 016
SONY	050, 089
SOUNDESIGN	025, 026, 027
SQUAREVIEW	023
SSS	000, 027
STARLITE	027
SUPREME	050, 089
SYLVANIA	001, 010
SYMPHONIC	023
TANDY	041
TECHNICS	008, 042
TECHNOI ACE	005, 026
TECHWOOD	008, 011
TEKNIKA	000, 001, 006, 010, 011, 012, 014, 016, 017, 026, 027
TELEFUNKEN	011, 015
TMK	011, 024, 025
TOSHIBA	012, 019, 020
TOTEVISION	006
VECTOR RESEARCH	001
VICTOR	009
VIDIKRON	010
VIDTECH	000, 025
WARDS	000, 001, 004, 010, 011, 016, 021, 025, 026
WESTINGHOUSE	031, 034, 035
YAMAHA	000, 001
ZENITH	001, 002, 014, 016, 031

**VIDEO setup codes**

Maker	Setup codes
ADMIRAL	021, 027, 077
ADVENTURA	006
AIKO	025
AIWA	005, 006
AKAI	002, 070
AMERICA ACTION	025
AMERICA HIGH	004
ASHA	023
AUDIOVOX	005
BEAUMARK	023
BELL&HOWELL	017
BROCKSONIC	021
BROKSONIC	014, 018, 020, 021
CCE	015, 025
CALIX	005
CANON	004
CARVER	016
CINERAL	025
CITIZEN	005, 025
COLT	015
CRAIG	005, 012, 015, 023, 024
CURTIS MATHES	002, 004, 013, 028, 070, 079
CYBERNEX	023
DAEWOO	010, 025
DENON	008
DYNATECH	006
ELECTROHOME	005
ELECTROPHONIC	005
EMEREX	012, 026
EMERSON	005, 006, 009, 014, 018, 020, 021, 025

Maker	Setup codes
FISHER	012, 017
FUJI	003, 004
FUNAI	006
GE	004, 013, 023, 027, 077
GARRARD	006
GOLDSTAR	000, 005
GRANDIENTE	006
HI-Q	012
HARLEY DAVIDSON	006
HARMAN/KARDON	000, 016
HARWOOD	015
HEADQUARTER	011
HITACHI	002, 006, 008, 070
JVC	001, 002, 070
JENSEN	002, 070
KEC	005, 025
KLH	015
KENWOOD	000, 001, 002, 070
KODAK	004, 005
LXI	005
LLOYD' S	006
LOGIK	015
MAGNASONIC	025
MAGNAVOX	004, 006, 007, 016, 019
MAGNIN	023
MARANTZ	004, 016
MARTA	005
MATSUSHITA	004, 028, 029, 079, 080
MEI	004
MEMOREX	004, 005, 006, 007, 011, 012, 017, 021, 023, 027, 031, 032, 077, 082, 083
MGA	009, 023
MGN TECHNOLOGY	023
MINOLTA	008
mitsubishi	001, 009, 027, 077
MOTOROLA	004, 016
MTC	006, 023
MULTITECH	006, 015
NEC	000, 001, 002, 017, 070
NIKKO	005
NOBLEX	023
OLYMPUS	004
OPIMUS	005, 017, 027, 028, 029, 030, 031, 032, 077, 079, 080, 081, 082, 083
ORION	014, 020, 021
PANASONIC	004, 022, 028, 029, 031, 079, 080, 082
PENNY	000, 004, 005, 008, 023
PENTAX	008
PHILCO	004, 021
PHILIPS	004, 016
PILOT	005
PIONEER	001
PROFITRONIC	023
PROSCAN	013
PROTEC	015
PULSAR	007
QUARTER	011
QUARTZ	011
QUASAR	004, 028, 029, 031, 079, 080, 082, 086

**VIDEO setup codes**

Maker	Setup codes
RCA	004, 008, 013, 019, 023, 027, 077
RADIO SHACK	006
RADIX	005
RANDEX	005
REALISTIC	004, 005, 006, 011, 012, 017, 027, 077
RUNCO	007
STS	008
SAMSUNG	010, 023, 070, 084
SANKY	007, 027, 077
SANSUI	001, 002, 006, 021, 024, 070
SANYO	011, 012, 017, 023
SCOTT	009, 010, 018, 020
SEARS	004, 005, 006, 008, 011, 012, 017
SEMP	010
SHARP	027, 077
SHINTOM	015
SHOGUN	023
SINGER	015
SONY	003, 004, 006, 026
SYVANIA	004, 006, 009, 016
SYMPHONIC	006
TATUNG	002, 070
TEAC	002, 006, 070
TECHNICS	004, 028, 079
TEKNIKA	004, 005, 006
THOMAS	006
TMK	023
TOSHIBA	009, 010
TOTEVISION	005, 023
UNITECH	023
VECTOR	010
VECTOR RESEARCH	000
VIDEO CONCEPTS	010
VIDEOSONIC	023
WARDS	004, 006, 008, 012, 013, 015, 016, 019, 023, 027, 077
WESTINGHOUSE	021, 025
XR-100	004, 006, 015
YAMAHA	000
ZENITH	003, 006, 007, 021

**Cable setup codes**

Maker	Setup codes
ABC	002, 003, 005, 006, 008, 009, 030, 076
ALLEGRO	018, 021
ARCHER	018, 026
BELL&HOWELL	009
CENTURY	018
CITIZEN	018, 021
COMTRONICS	014
CONTEC	011
EASTEN	001
EMERSON	026
EVERQUEST	010, 014
FOCUS	022
GARRARD	018
GEMINI	010, 081
GENERAL INSTRUMENT	006, 032, 033, 034
GOLDSTAR	014, 017
GOODMIND	026, 029
HAMLIN	004, 012, 013, 020
HITACHI	006
JASCO	010, 018, 021
JERROLD	002, 006, 007, 009, 010, 032, 033, 034
MEMOLEX	000
MOVIE TIME	015, 091
NSC	015
OAK	011
OPTIMUS	031
PANASONIC	000, 016, 031
PARAGON	000
PHILIPS	018
PIONEER	017, 025
POPULAR MECHANICS	022
PULSAR	000, 082
QUASAR	000
RCA	031
RADIO SHACK	010, 021, 026, 028
RECOTON	022
REGAL	012, 020
REGENCY	001
REMBRANDT	006, 085
RUNCO	000
SL MARX	014
SAMSUNG	014, 017
SCIENTIFIC ATLANTA	003, 023, 027, 030, 076
SIGNAL	010, 014
SIGNATURE	006
SPRUCER	031, 083
STARCOM	002, 010
STARGATE	010, 014, 026
STARQUEST	010
TV86	015
TELEVIEW	014
TOCOM	007, 008
TOSHIBA	000
TUSA	010
UNIKA	018
UNIVERSAL	018, 019
VIEWSTAR	015
ZENITH	000, 024
ZENTEK	022

**Satellite setup codes**

Maker	Setup codes
ALPHASTAR	065, 093
CHAPARRAL	058
ECHOSTAR	066
EXPREEVU	066
GENERAL INSTRUMENT	072, 073, 075, 087
HTS	066
HITACHI	068
HUGHES NET. SYS	064
JVC	066
JERROLD	072, 073
MEGAVOX	062, 063
MEMOREX	063
NEXT LEVEL	075
PANASONIC	074, 084
PHILIPS	062, 063
PRIMESTAR	072, 073
RCA	057, 059, 060, 069
RADIO SHACK	075, 089
REALISTIC	071
SONY	061
STAR CHOICE	075
TOSHIBA	067, 091
UNIDEN	062, 063, 071
ZENITH	070, 086

**DVD player setup codes**

Maker	Setup codes
APEX	064
HARMAN/KARDON	009
JVC	008
KENWOOD	000, 005
MEGAVOX	013
MITSUBISHI	001
ONKYO	013
PANASONIC	060
PHILIPS	006, 013
PIONEER	003, 063, 069
PROSCAN	002
RCA	002
SAMSUNG	066, 081
SHERWOOD	001, 012, 014, 015, 016, 017 018, 065, 067, 080
SONY	004
TECHNICS	060
THETA DIGITAL	063
TOSHIBA	013
YAMAHA	007, 060
ZENITH	010, 013
CHINA DVD	011, 068

**CD setup codes**

Maker	Setup codes
AIWA	042, 072
BURMESTER	051
CALIFORNIA AUDIO LAB	034
CARVER	042, 044, 052
DKK	032, 033
DENON	070, 076
FISHER	044, 075
GARRARD	050, 051
GENEXXA	036, 077
HARMAN/KARDON	042, 043
HITACHI	036
JVC	039
KENWOOD	035, 048, 056, 057, 071
KRELL	042
LINN	042
MCS	034
MTC	051
MEGAVOX	042, 077
MARANTZ	034, 042, 045
MISSION	042
NSM	042
NIKKO	059, 075
ONKYO	040, 058
OPIMUS	033, 036, 041, 044, 051, 052, 053, 071, 077
PANASONIC	032, 034, 073
PARASOND	051
PHILIPS	042, 055
PIONEER	036, 049, 053
PROTON	042
QED	042
QUASAR	034
RCA	038, 044, 077, 078
REALISTIC	044, 045, 051
ROTEL	042, 051
SAE	042
SANSUI	042
SANYO	044
SCOTT	077
SEARS	077
SHARP	045, 077, 079
SHERWOOD	000, 013, 027, 038, 039, 040, 041
SONY	033, 046, 054
SOUNDESIGN	032, 041
TASCAM	051
TEAC	045, 050, 051, 075
TECHNICS	034, 073
VICTOR	039
WARDS	038, 042
YAMAHA	037, 047
YORX	074

## Other components' operations

Refer to the following for the type of remote control operations available for each component.

- 1 Press the INPUT SELECTOR key ( DVD/CD, VIDEO1, VIDEO2, or TV ) which you registered code to control component you desire.
- 2 Press the keys corresponding to the operations you desire. Refer to the following sections for details.

- When pressing keys in succession, press each key firmly and be sure to wait at least 1 second before pressing the next key.
- Numeric keys function the same as the numeric keys on the original remote.

These keys can be used to perform the basic operations of KENWOOD and other manufacturers' components which the setup code for each component had been entered beforehand.

### TV operation keys

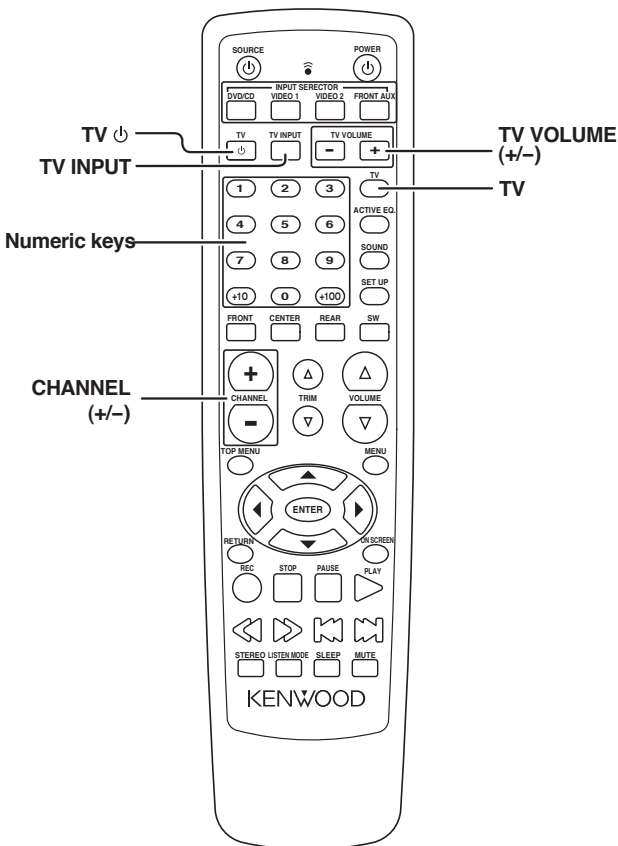

### VIDEO operation keys

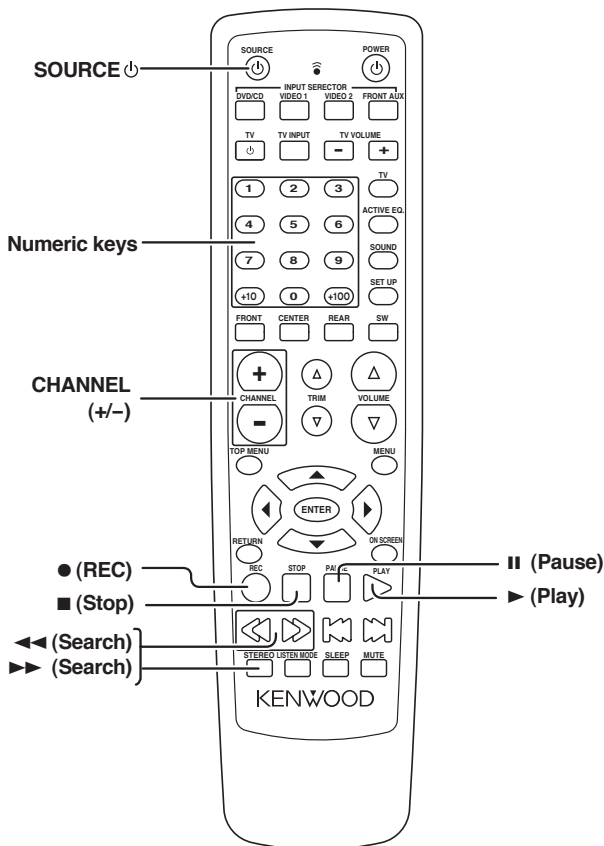



Satellite operation keys

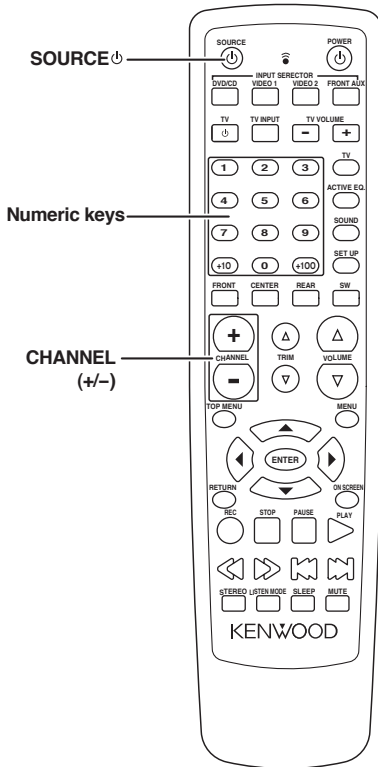

Cable operation keys

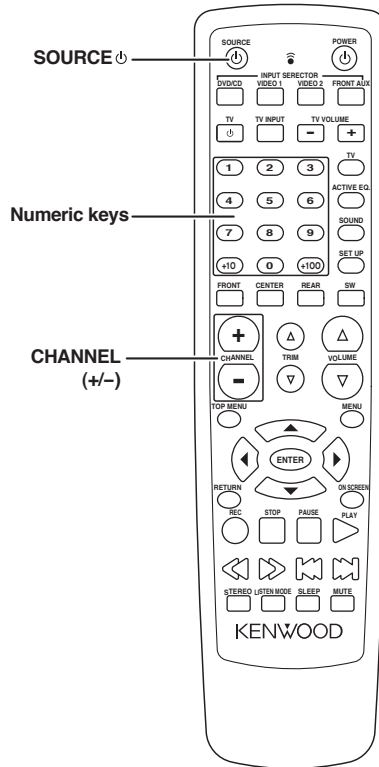

DVD player operation keys

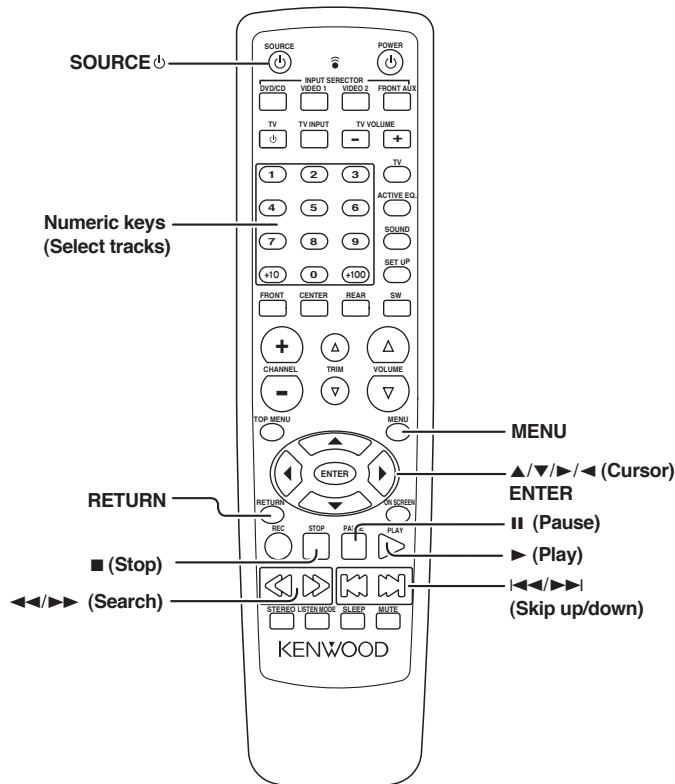

Notes

1. Certain codes may only operate some of the function available on a given model.
2. The above show the typical type functions available for each component. Some manufacturers use different key combinations to perform similar functions. For that reason, we have programmed extra functions on some of the unused number keys to help you control your equipment.

## In case of difficulty

### Resetting the Microcomputer

The microcomputer may malfunction (unit cannot be operated, or shows an erroneous display) if the power cord is unplugged while the power is ON, or due to some other external factor. If this happens, execute the following procedure to reset the microcomputer and return the unit to its normal operating condition.

**Unplug the power cord after turn the POWER key OFF. Then, while holding down the POWER key, plug the power cord.**

- Please note that resetting the microcomputer will clear the contents of the memory and returns the unit to the state it was in when it left the factory.

### Amplifier

Symptom	Cause	Remedy
No sound from the speakers.	<ul style="list-style-type: none"> <li>• The speaker cords are disconnected.</li> <li>• VOLUME is set to the minimum position.</li> <li>• MUTE is ON.</li> </ul>	<ul style="list-style-type: none"> <li>• Connect them properly referring to "Connecting the speakers" → [11] → [12]</li> <li>• Adjust the volume to a proper level.</li> <li>• Turn OFF the MUTE. → [19]</li> </ul>
The standby indicator blinks and sound is not output.	<ul style="list-style-type: none"> <li>• Speaker cords are short-circuited.</li> </ul>	<ul style="list-style-type: none"> <li>• Turn the power off, eliminate the short-circuiting, then turn on the power again.</li> </ul>
Sound is not output from one of the speakers.	<ul style="list-style-type: none"> <li>• The speaker cord is disconnected.</li> </ul>	<ul style="list-style-type: none"> <li>• Connect it properly referring to "Connecting the speakers" . → [11] → [12]</li> </ul>
Sound is not output from the surround speakers and / or the center speaker, or their sound is very small.	<ul style="list-style-type: none"> <li>• The surround speaker cords and/or the center speaker cord is disconnected.</li> <li>• A surround mode has not been engaged.</li> <li>• The surround and/or center volume controls are set to the minimum level.</li> </ul>	<ul style="list-style-type: none"> <li>• Connect it properly referring to "Connecting the speakers" . → [11] → [12]</li> <li>• Select a surround mode.</li> <li>• Adjust the speaker levels using the test tone. → [16]</li> </ul>
When playing a Dolby Digital source signal using a DVD player, the sound is cut off soon after it starts.	<ul style="list-style-type: none"> <li>• There are many possible causes for this problem, depending on the type of DVD player used.</li> </ul>	<ul style="list-style-type: none"> <li>• Set the input mode to digital manual before starting playback of the Dolby Digital source. → [9]</li> </ul>
No sound is produced during playback from a DVD player.	<ul style="list-style-type: none"> <li>• The input mode is set to digital manual.</li> </ul>	<ul style="list-style-type: none"> <li>• Press the INPUT MODE key to select to full auto mode. → [9]</li> </ul>

### Remote control unit

Symptom	Cause	Remedy
Certain inputs cannot be selected using the remote control.	<ul style="list-style-type: none"> <li>• No setup codes registered for the respective input(s).</li> </ul>	<ul style="list-style-type: none"> <li>• Register a setup code at the respective input(s). → [26]</li> </ul>
Remote control operation is not possible.	<ul style="list-style-type: none"> <li>• The remote control is set to a different operation mode.</li> <li>• Batteries are exhausted.</li> <li>• The remote control unit is too far away from the main system, controlling angle is too large, or there is an obstacle between the amplifier and the remote.</li> <li>• No tape or CD is placed in the source component.</li> <li>• An attempt is made to play a tape which is being recorded in the cassette deck.</li> </ul>	<ul style="list-style-type: none"> <li>• Press any of the <b>INPUT SELECTOR</b> keys to select the appropriate operation mode.</li> <li>• Replace with new batteries.</li> <li>• Operate the remote control unit within the controllable range. → [14]</li> <li>• Place the tape or CD in the source component which you want to play.</li> <li>• Wait until recording has completed.</li> </ul>

# Specifications

## KAF-S500

### AUDIO section

Rated power output during STEREO operation

50 watts per channel minimum RMS, both channels driven, at 6  $\Omega$  from 20Hz to 18kHz with no more than 10% total harmonic distortion.

Rated power output during SURROUND operation

FRONT (1 kHz, 10 % T.H.D. at 6  $\Omega$ ) ..... 50 W + 50 W  
CENTER (1 kHz, 10 % T.H.D. at 6  $\Omega$ ) ..... 50 W  
SURROUND (1 kHz, 10 % T.H.D. at 6  $\Omega$ ) ..... 50 W + 50 W  
SUBWOOFER / BACK SURROUND (1 kHz, 10 % T.H.D. at 6  $\Omega$ ) ..... 50 W

Input sensitivity / impedance

(DVD/CD, VIDEO 1, VIDEO 2, FRONT AUX) ... 270 mV / 200 k $\Omega$

### DIGITAL AUDIO section

Sampling frequency ..... 32 kHz, 44.1 kHz, 48 kHz, 96 kHz

Input level / wave length

Optical ..... (-15 dBm ~ -24 dBm), 660 nm  $\pm$  30 nm

### GENERAL

Power consumption ..... 90 W

Standby Power consumption ..... 1.5 W

Dimensions ..... W : 220 mm (8-11/16")  
H : 78 mm (3-1/16")  
D : 329 mm (12-15/16")

Weight (Net) ..... 3.0 kg (6.6 lb)

## KSW-S500

### [FRONT SPEAKERS]

Type ..... Acoustic Air Suspension  
Magnetically shielded ..... JEITA standard  
Tweeter ..... 2.5 cm(1") x 1 Dome  
Woofer ..... 5 cm(2") x 1 Cone  
Impedance ..... 8  $\Omega$   
Frequency Response ..... 140 Hz ~ 40,000 Hz  
Sensitivity ..... 78 dB  
Crossover Frequency ..... 8 kHz  
Rated Input Power ..... 25 W  
Max. Input Power ..... 50 W  
Dimensions(with Grille) ..... W : 77 mm (3-1/16")  
H : 140 mm (5-1/2")  
D : 114 mm (4-1/2")

Weight (Net) ..... 0.6 kg (1.3 lb)/piece

### [CENTER SPEAKER]

Type ..... Acoustic Air Suspension  
Magnetically shielded ..... JEITA standard  
Tweeter ..... 2.5 cm(1") x 1 Dome  
Woofer ..... 5 cm(2") x 2 Cone  
Impedance ..... 8  $\Omega$   
Frequency Response ..... 130 Hz ~ 40,000 Hz  
Sensitivity ..... 80 dB  
Crossover Frequency ..... 8 kHz  
Rated Input Power ..... 25 W  
Max. Input Power ..... 50 W  
Dimensions(with Grille) ..... W : 210 mm (8-1/4")  
H : 77 mm (3-1/16")  
D : 114 mm (4-1/2")

Weight (Net) ..... 0.9 kg (2.0 lb)

### [SURROUND SPEAKERS]

Type ..... Acoustic Air Suspension  
Magnetically shielded ..... JEITA standard  
Full Range ..... 5 cm(2") x 1 Cone  
Impedance ..... 8  $\Omega$   
Frequency Response ..... 140 Hz ~ 20,000 Hz  
Sensitivity ..... 78 dB  
Rated Input Power ..... 25 W  
Max. Input Power ..... 50 W  
Dimensions(with Grille) ..... W : 77 mm (3-1/16")  
H : 140 mm (5-1/2")  
D : 114 mm (4-1/2")

Weight (Net) ..... 0.6 kg (1.3 lb)/piece

### [SUBWOOFER SPEAKER]

Type ..... Bass Reflection  
Magnetically shielded ..... JEITA standard  
Woofer ..... 16 cm(6-1/2") x 1 Cone  
Impedance ..... 8  $\Omega$   
Frequency Response ..... 43 Hz ~ 150 Hz  
Sensitivity ..... 82 dB  
Rated Input Power ..... 25 W  
Max. Input Power ..... 50 W  
Dimensions(with Grille) ..... W : 220 mm (8-11/16")  
H : 300 mm (11-13/16")  
D : 287 mm (11-5/16")

Weight (Net) ..... 4.9 kg (10.8 lb)

### Memory back up function

Please note that the following items will be deleted from the unit's memory if the power cord is disconnected from the AC outlet for approximately 1 day.

- Input selector settings.
- Volume level.
- TONE ON/OFF.
- BASS, TREBLE, INPUT level.
- Listen mode setting.
- Speaker setting.
- Distance settings.
- Each channel's level.

### Notes

1. KENWOOD follows a policy of continuous advancements in development. For this reason specifications may be changed without notice.
2. The full performance may not be exhibited in an extremely cold location (under a water-freezing temperature).

---

# KENWOOD

***For your records***

Record the serial number, found on the back of the unit, in the spaces designated on the warranty card, and in the space provided below. Refer to the model and serial numbers whenever you call upon your dealer for information or service on this product.

Model \_\_\_\_\_ Serial Number \_\_\_\_\_

## Free Manuals Download Website

<http://myh66.com>

<http://usermanuals.us>

<http://www.somanuals.com>

<http://www.4manuals.cc>

<http://www.manual-lib.com>

<http://www.404manual.com>

<http://www.luxmanual.com>

<http://aubethermostatmanual.com>

Golf course search by state

<http://golfingnear.com>

Email search by domain

<http://emailbydomain.com>

Auto manuals search

<http://auto.somanuals.com>

TV manuals search

<http://tv.somanuals.com>