

KENWOOD

KTC-1000R

HIDEAWAY TUNER AMPLIFIER

INSTRUCTION MANUAL

KENWOOD CORPORATION

Safety precautions

▲WARNING

To prevent injury and/or fire, take the following precautions:

- Ensure that the unit is securely installed. Otherwise it may fly out of place during collisions and other jolts.
- When extending the ignition, battery or ground cables, make sure to use automotive-grade cables or other cables with an area of 0.75mm² (AWG18) or more to prevent cable deterioration and damage to the cable coating.
- To prevent short circuits, never put or leave any metallic objects (e.g., coins or metal tools) inside the unit.
- If the unit starts to emit smoke or strange smells, turn off the power immediately and consult your Kenwood dealer.

▲CAUTION

To prevent damage to the machine, take the following precautions:

- Make sure to ground the unit to a negative 12V DC power supply.
- Do not open the top or bottom covers of the unit.
- Do not install the unit in a spot exposed to direct sunlight or excessive heat or humidity. Also avoid places with too much dust or the possibility of water splashing.
- When replacing a fuse, only use a new one with the prescribed rating. Using a fuse with the wrong rating may cause your unit to malfunction.
- To prevent short circuits when replacing a fuse, first disconnect the wiring harness.
- During installation, do not use any screws except for the ones provided. The use of improper screws might result in damage to the main unit.
- When drilling a hole in the car to fix the brackets, make sure not to damage the fuel tank, brake tube, wiring harnesses, etc. on the other side.

NOTE

If you experience problems during installation, consult your Kenwood dealer.

Cleaning the Unit

If the surface is dirty, wipe it clean with a silicon cloth or soft dry cloth with the power off.

▲CAUTION

Do not use hard cloths or paint thinner, alcohol, or other volatile solvents.

IMPORTANT INFORMATION

Models which can be connected with this device are those that went on sale from 1998 (mentioned below). (As of June, 1999).

■ **Audio systems for controlling this set**

This set is operated with a control unit, and does not have its own controls. The set can be operated with the following control units.

KVC-1000, VZ907^{#1,2}

■ **CD player**

KDC-D300

■ **CD auto changer**

KDC-C712, KDC-C711
KDC-C662, KDC-C462, KDC-C661
KDC-CPS82^{#2}, KDC-CPS81^{#2,3}
C907^{#3}

■ **MD auto changer**

KMD-D400

■ **DAB tuner**

KTC-959DAB^{#1}

■ **CD/MD changer switching unit with auxiliary RCA stereo input**

KCA-S210A^{#2}

NOTE



- If the relevant connected device has a PROTOCOL SWITCH or O-N SWITCH, be sure to set the switch to "N". Operation will fail if set to "O".
 - It is possible to interconnect 2 CD/MD changers via the MZ-BUS and 5L interface.^{#3}
 - Cannot be connected to Kenwood disc changers (those that went on sale from 1997) or those manufactured by other companies, and without a "O-N" switch.
- #1: The KTC-959DAB cannot be used with the VZ907.
#2: AUX operation is not possible with the VZ907.
#3: Do not connect the C907 and KDC-CPS81 at the same time. The equipment will cease functioning.

Installation

■ Accessories

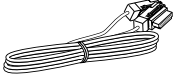

External view

..... Number of items

①	2
④	2
⑦	1

External view

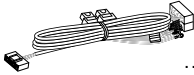
..... Number of items

②	4
⑤	1
⑧	1

External view

..... Number of items

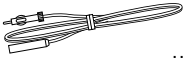
③	4
⑥	1

▲CAUTION

The use of any accessories except for those provided might result in damage to the unit. Make sure only to use the accessories shipped with the unit, as shown above.

■ Installation Procedure

1. To prevent short circuits, remove the key from the ignition and disconnect the ⊖ terminal of the battery.
2. Make the proper input and output cable connections for each unit.
3. Connect the speaker cables of the wiring harness.
4. Take Connector B on the wiring harness and connect it to the speaker connector in your vehicle.
5. Take Connector A on the wiring harness and connect it to the external power connector on your vehicle.
6. Install the unit in your car.
7. Reconnect the ⊖ terminal of the battery.
8. Press the reset button.

▲CAUTION

- If your car is not prepared for this special connection-system, consult your KENWOOD dealer.
- Only use antenna conversion adapters (ISO-JASO) when the antenna cord has an ISO plug.
- Make sure that all cable connections are securely made by inserting jacks until they lock completely.
- If your vehicle's ignition does not have an ACC position, or if the ignition cable is connected to a power source with constant voltage such as a battery cable, the power will not be linked with the ignition (i.e., it will not turn on and off along with the ignition). If you want to link the unit's power with the ignition, connect the ignition cable to a power source that can be turned on and off with the ignition key.

- If the fuse blows, first make sure that the cables have not caused a short circuit, then replace the old fuse with one with the same rating.
- Do not let unconnected cables or terminals touch metal on the car or anything else conducting electricity. To prevent short circuits do not remove the caps from unused terminals or from the ends of the unconnected cables.
- Connect the speaker cables correctly to the terminals to which they correspond. The unit may receive damage or fail to work if you share the ⊖ cables and/or ground them to any metal part in the car.
- After the unit is installed, check whether the brake lamps, blinkers, wipers, etc. on the car are working properly.
- Insulate unconnected cables with vinyl tape or other similar material.
- During use, the surface temperature of this unit will become high, therefore it should not be mounted where anything sensitive to the heat, such as people or resins, would come into contact with it.
- Do not install the unit under the carpet. Otherwise heat build-up occurs and the unit may be damaged.
- Install this unit in a location which allows heat to easily dissipate. Once installed, do not place any object on top of the unit.
- Install the unit securely in a location that does not interfere with driving.

Installation

■ Connecting Cables to Terminals

▲WARNING

If you connect the ignition cable (red) and the battery cable (yellow) to the car chassis (ground), you may cause a short circuit, that in turn may start a fire. Always connect those cables to the power source running through the fuse box.

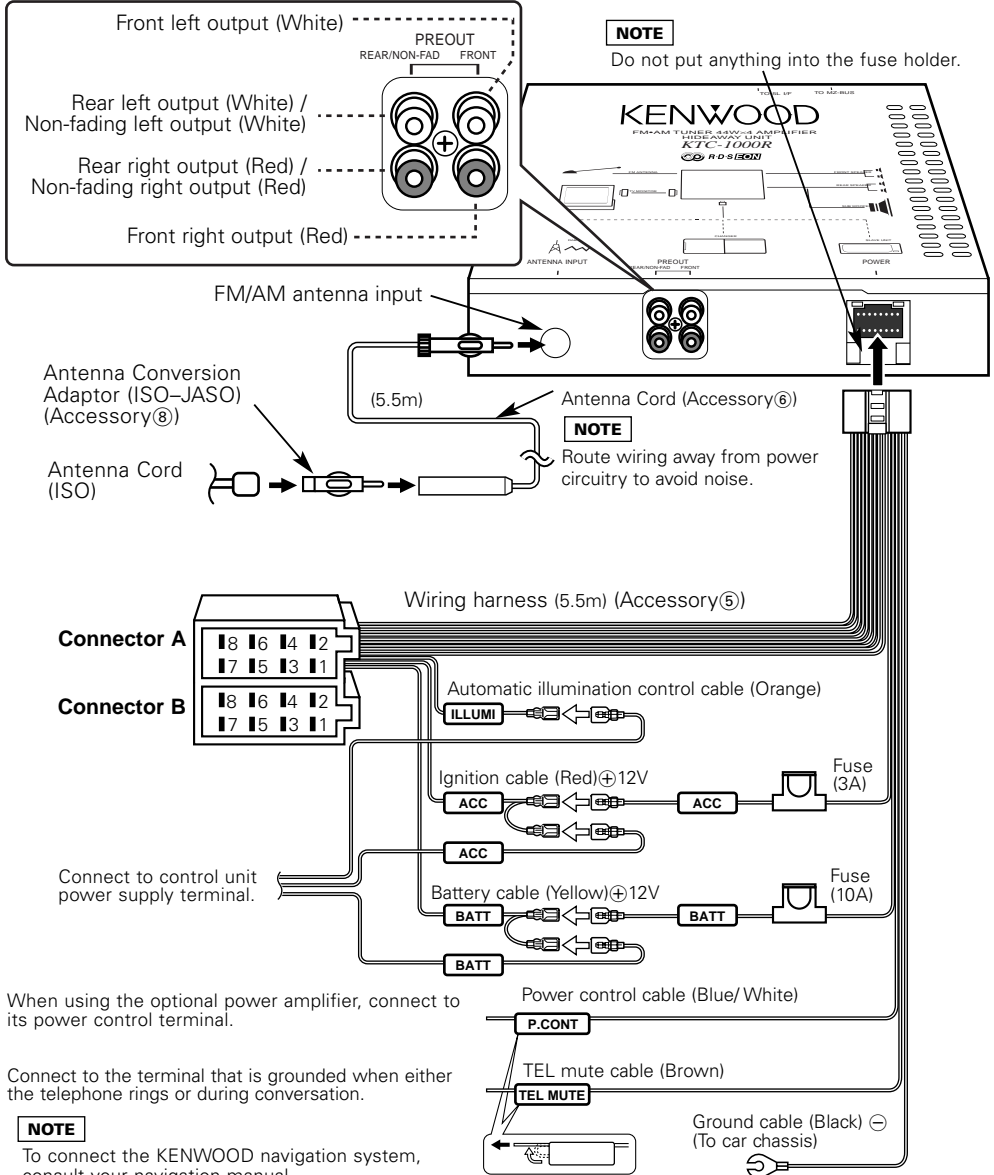

⚠WARNING Connecting the ISO Connector

The pin arrangement for the ISO connectors depends on the type of vehicle you drive. Make sure to make the proper connections to prevent damage to the unit.

The default connection for the wiring harness is described in [1] below. If the ISO connector pins are set as described in [2] or [3], make the connection as illustrated.

- [1] (Default setting) The A-7 pin (red) of the vehicle's ISO connector is linked with the ignition, and the A-4 pin (yellow) is connected to the constant power supply.

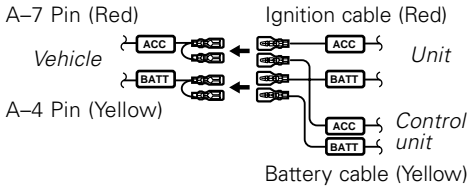

- [2] The A-7 pin (red) of the vehicle's ISO connector is connected to the constant power supply, and the A-4 pin (yellow) is linked to the ignition.

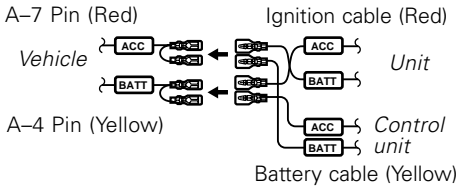

- [3] The A-7 pin (red) of the vehicle's ISO connector is not connected to anything, whilst the A-4 pin (yellow) is connected to the constant power supply (or both the A-7 (red) and A-4 (yellow) pins are connected to the constant power supply).

Connect to a power source that can be turned on and off with the ignition key. ← Ignition cable (Red)

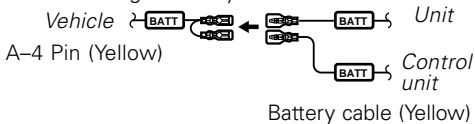

Connector Function Guide

Pin Numbers for ISO Connectors	Cable Colour	Functions
External Power Connector		
A-4	Yellow	Battery
A-5	Blue/White	Power Control
A-6	Orange	Dimmer
A-7	Red	Ignition (ACC)
Speaker Connector		
B-1	Purple	Rear Right (+)
B-2	Purple/Black	Rear Right (-)
B-3	Gray	Front Right (+)
B-4	Gray/Black	Front Right (-)
B-5	White	Front Left (+)
B-6	White/Black	Front Left (-)
B-7	Green	Rear Left (+)
B-8	Green/Black	Rear Left (-)

Installation

■ When the control unit is the KVC-1000

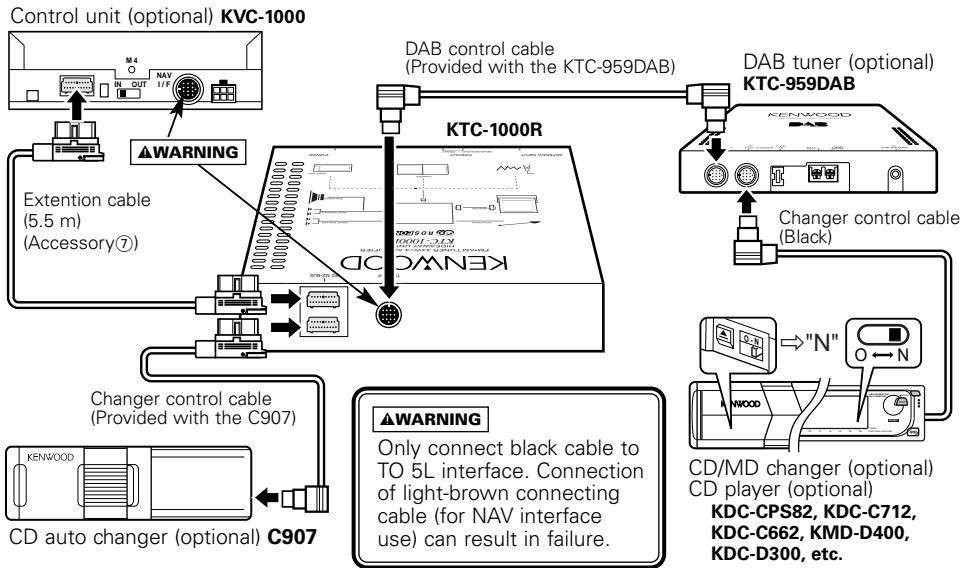

■ When the control unit is the VZ907

NOTE

Some model cannot be connected and certain features are unavailable. For details, see IMPORTANT INFORMATION (see page 2).

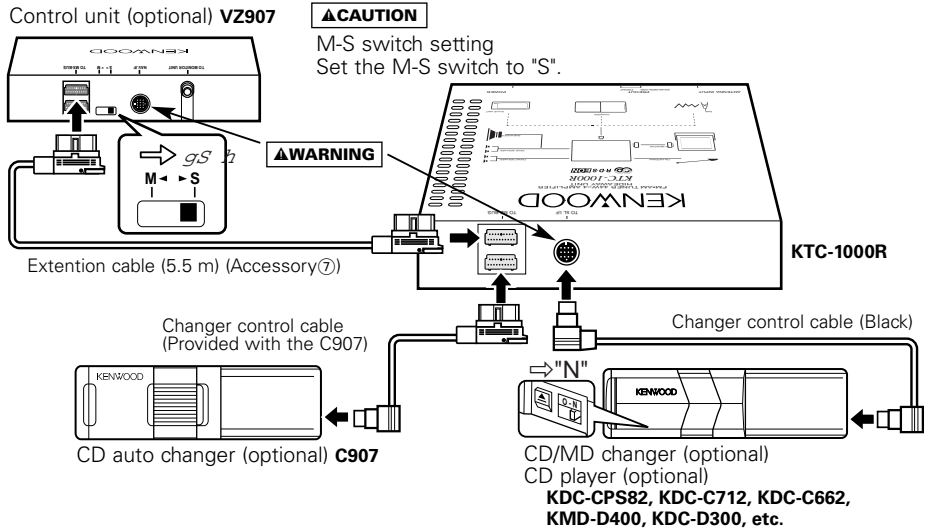

■ When two CD/MD changers are interconnected

The disk changers are distinguished by source select disk-changer 1 and disk-changer 2.

NOTE

If the relevant connected device has a PROTOCOL SWITCH or O-N SWITCH, be sure to set the switch to "N".

Example 1 **NOTE** Do not connect the C907 and KDC-CPS81 at the same time. The equipment will cease functioning.

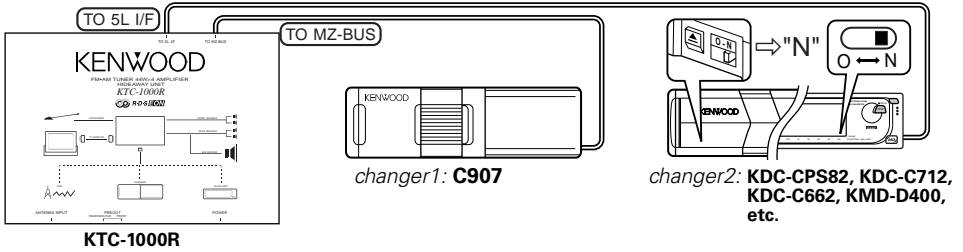

Example 2

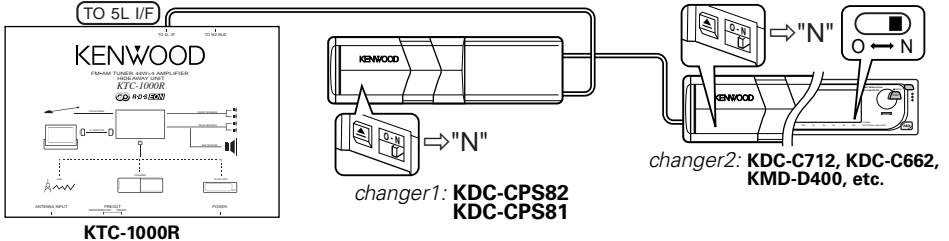

Example 3

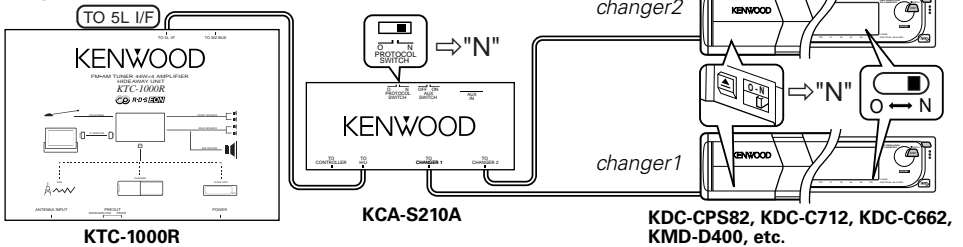

Example 4 **NOTE** If the control unit is KVC-1000, it is not possible to interconnect two C907 units.

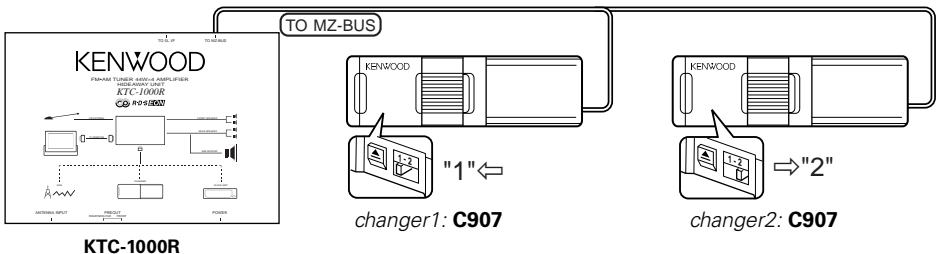

Installation

■ Installation for Hideaway unit

● Securing to audio board

- 1 Attach the installation brackets to the sides of the hideaway unit using the sems bolts (M4 × 8 mm).

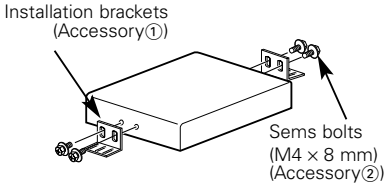

- 2 Use the tapping screw (ø4 × 16 mm) to secure the hideaway unit to the audio board.

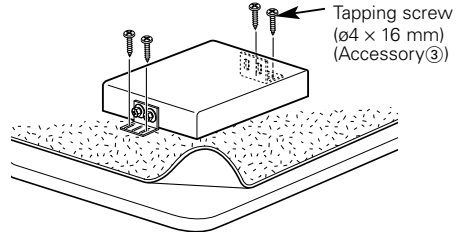

● Securing to pile carpet

Peel the protective strips off of the velcro strips, attach them to the bottom of the hideaway unit, and secure to the pile carpet.

▲ CAUTION

Please do not install the unit near the dashboard, the rear tray, or other important components. Doing so could lead to injury or accident should the unit come off due to a shock and strike a person or an important component. Tapping screws should be used for mounting. (Attachment with velcro strips, although easy, can come off with a shock.)

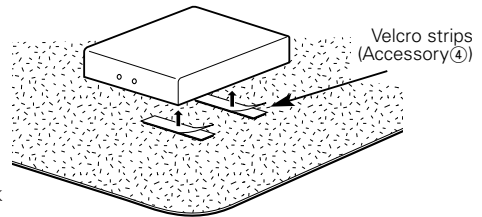

Troubleshooting Guide

What might appear to be a malfunction in your unit may just be the result of slight misoperation or miswiring. Before calling service, first check the following table for possible problems.

PROBLEM	POSSIBLE CAUSE	SOLUTION
The power does not turn on.	The fuse has blown.	After checking for short circuits in the cables, replace the fuse with one having the same rating.
No sound can be heard, or the volume is low.	<ul style="list-style-type: none">• The Attenuator function is turned on.• The fader and/or balance settings are set all the way to one side.• The input/output cables or wiring harness are connected incorrectly.	<ul style="list-style-type: none">• Turn off the Attenuator function.• Reset the fader and/or balance settings.• Reconnect the input/output cables and/or the wiring harness correctly. See the section on "Connecting Cables to Terminals".
Nothing happens when the buttons are pressed.	The computer chip in the unit is not functioning normally.	Press the reset button on the unit

Troubleshooting Guide

PROBLEM	POSSIBLE CAUSE	SOLUTION
The sound quality is poor or distorted.	<ul style="list-style-type: none"> • A speaker cable may be pinched by a screw in the car. • The speakers are not cabled correctly. 	<ul style="list-style-type: none"> • Check the speaker wiring.. • Reconnect the speaker cables so that each output terminal is connected to a different speaker.
Radio reception is poor.	<ul style="list-style-type: none"> • The car antenna is not extended. • The antenna control cable is not connected. • Adverse effect of noise from power cable, etc. 	<ul style="list-style-type: none"> • Pull out the antenna all the way. • Connect the cable correctly, referring to the section on "Connecting Cables to Terminals". • Be sure to install the antenna cable away from the power cable.
The memory is erased when the ignition is turned off.	<ul style="list-style-type: none"> • The battery cable has not been connected to the proper terminal. • The ignition and battery cable are incorrectly connected. 	<ul style="list-style-type: none"> • Connect the cable correctly, referring to the section on "Connecting Cables to Terminals". • Connect the cable correctly, referring to the section on "Connecting Cables to Terminals".

The following indications are used to inform you that there is a problem with the connections of the system.

- BUS-E01: The M-S switch of the Monitor connected to the BUS terminal is set to "M".
 ⇒ Switch the Monitor's M-S switch to "S".
 The "MASTER SW" cable of the monitor power supply harness is connected to ⊖.
 ⇒ Do not connect the "MASTER SW" cable.
- BUS-E50: Two or more center units are connected.
- BUS-W02: The No. switch of the connected disc changers is set to the same number (1 or 2) for both units.
 ⇒ Set the No. switch of one disc changer to "1" and the other unit to "2" to enable proper use.
- BUS-W08: Two or more Monitors are connected to the BUS terminal.

Specifications

Specifications subject to change without notice.

FM tuner section

Frequency range (50 kHz Space)
87.5 MHz – 108.0 MHz
 Usable sensitivity (S/N = 26dB)0.7 μ V/75 Ω
 Quieting Sensitivity (S/N = 46dB)1.6 μ V/75 Ω
 Frequency response (\pm 3.0 dB)30 Hz – 15 kHz
 Signal to Noise ratio (MONO)65 dB
 Selectivity (DIN) (\pm 400 kHz) \geq 80 dB
 Stereo separation (1 kHz)35 dB

MW tuner section

Frequency range (9 kHz Space)
531 kHz – 1611 kHz
 Usable sensitivity (S/N = 20dB)25 μ V

LW tuner section

Frequency range153 kHz – 281 kHz
 Usable sensitivity (S/N = 20dB)45 μ V

Audio section

Maximum output power44 W \times 4
 Output power (DIN 45324, +B=14.4 V)28 W \times 4
 Tone action
 Bass:100 Hz \pm 10 dB
 Treble:10 kHz \pm 10 dB
 Preout level / load4 V / 10 k Ω (During CD play)
 Preout Impedance \leq 80 Ω

General

Operating voltage14.4 V (11 – 16 V allowable)
 Current consumption10 A at Rated power
 Installation size (W \times H \times D)213 \times 40 \times 148 mm
 Weight990 g

KENWOOD

Free Manuals Download Website

<http://myh66.com>

<http://usermanuals.us>

<http://www.somanuals.com>

<http://www.4manuals.cc>

<http://www.manual-lib.com>

<http://www.404manual.com>

<http://www.luxmanual.com>

<http://aubethermostatmanual.com>

Golf course search by state

<http://golfingnear.com>

Email search by domain

<http://emailbydomain.com>

Auto manuals search

<http://auto.somanuals.com>

TV manuals search

<http://tv.somanuals.com>