

KENWOOD

MICRO HI-FI COMPONENT SYSTEM

HM-382MD

INSTRUCTION MANUAL

KENWOOD CORPORATION



B60-4719-08 (EN)

2 Before applying power

 **Caution : Read this page carefully to ensure safe operation.**

Units are designed for operation as follows.

Europe and U.K. AC 230 V only
Australia AC 240 V only

***Other countries AC 110-120 / 220-240 V switchable**

For the United Kingdom

Factory fitted moulded mains plug

1. The mains plug contains a fuse. For replacement, use only a 13-Amp ASTA-approved (BS1362) fuse.
2. The fuse cover must be refitted when replacing the fuse in the moulded plug.
3. Do not cut off the mains plug from this equipment. If the plug fitted is not suitable for the power points in your home or the cable is too short to reach a power point, then obtain an appropriate safety approved extension lead or adapter, or consult your dealer.
If nonetheless the mains plug is cut off, remove the fuse and dispose of the plug immediately, to avoid a possible shock hazard by inadvertent connection to the mains supply.

IMPORTANT : The wires in the mains lead are coloured in accordance with the following code:

Blue : Neutral
Brown : Live

Do not connect those leads to the earth terminal of a three-pin plug.

*AC voltage selection

The AC voltage selector switch on the rear panel is set to the voltage that prevails in the area to which the unit is shipped. Before connecting the power cord to your AC outlet, make sure that the setting position of this switch matches your line voltage. If not, it must be set to your voltage in accordance with the following direction.

AC voltage selector switch

Move switch lever to match your line voltage with a small screwdriver or other pointed tool.

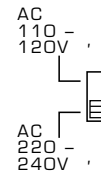





Note:

Our warranty does not cover damage caused by excessive line voltage due to improper setting of the AC voltage selector switch.

Safety precautions

WARNING : TO PREVENT FIRE OR ELECTRIC SHOCK, DO NOT EXPOSE THIS APPLIANCE TO RAIN OR MOISTURE.

  	CAUTION: TO REDUCE THE RISK OF ELECTRIC SHOCK, DO NOT REMOVE COVER (OR BACK). NO USER-SERVICEABLE PARTS INSIDE. REFER SERVICING TO QUALIFIED SERVICE PERSONNEL.
	THE LIGHTNING FLASH WITH ARROWHEAD SYMBOL, WITHIN AN EQUILATERAL TRIANGLE, IS INTENDED TO ALERT THE USER TO THE PRESENCE OF UNINSULATED "DANGEROUS VOLTAGE" WITHIN THE PRODUCT'S ENCLOSURE THAT MAY BE OF SUFFICIENT MAGNITUDE TO CONSTITUTE A RISK OF ELECTRIC SHOCK TO PERSONS.
	THE EXCLAMATION POINT WITHIN AN EQUILATERAL TRIANGLE IS INTENDED TO ALERT THE USER TO THE PRESENCE OF IMPORTANT OPERATING AND MAINTENANCE (SERVICING) INSTRUCTIONS IN THE LITERATURE ACCOMPANYING THE APPLIANCE.

The marking of products using lasers (Except for some areas)

**CLASS 1
LASER PRODUCT**

The marking is located on the rear panel and says that the component uses laser beams that have been classified as Class 1. It means that the unit is utilizing laser beams that are of a weaker class. There is no danger of hazardous radiation outside the unit.

Contents

Preparation section

- ⚠ **Before applying power** 2
- ⚠ **Safety precautions** 2
 - Special features 4
 - In regard to demonstration 4
 - Accessories 5
- System connection** 6
- ⚠ **Connection of the System Accessories** 6
- ⚠ **Connection of Other Accessories
(Commercially Available Parts)** 8
- Controls and indicators** 9
 - Display 9
 - Main unit 10
- Operation of remote control unit** 12

Basic section

- Basic use method** 14
- Playback of CD** 16
- Playback of Mini Disc** 18
 - Searching a desired track by its title
(TITLE SEARCH) 20
- Playback of tape** 22
- Receiving broadcast station** 24
 - Collective presetting of stations (auto preset) 26
 - Channel space setting 26
- Recording on MD** 28
- Recording on TAPE** 30

Application section

- Various CD/MD playback features** 32
 - Listening in the desired sequence
(program playback) 32
 - Repeated playback 33
 - Listening to an unexpected title sequence
(random playback) 34
- R.D.S. (Radio Data System)
(Except for some areas)** 35
 - Searching for a desired program type
(PTY search) 36

- Convenient recording methods** 39
 - Selection of the recording type 39
 - All-track high-speed recording (CD→MD) 40
 - One-touch edit recording (CD→MD /CD→TAPE) 41
 - Twin recording onto MD and tape (TWIN REC) 42
 - Program recording
(CD→MD / CD→TAPE / TWIN REC) 43
 - Program recording (MD→TAPE) 44
- MD Edit Functions** 45
 - Selecting the editing function type 45
 - Moving a single track (TRACK MOVE) 46
 - Dividing a track (TRACK DIVIDE) 48
 - Combining two tracks (TRACK COMBINE) 49
 - Erasing a single track (TRACK ERASE)
or erasing all tracks on a disc (ALL ERASE) 50
 - Assigning a title to a disc or track 51
 - Changing or deleting a title 54
 - Erasing all titles 54
 - Copying titles in title memos for use
as titles of other MDs or tracks 55
 - Entering characters in title memo (TITLE MEMO) 56
- Tone adjustment** 57
 - Tone adjustment 57
 - Balance adjustment 57
- Listening to an AUX input source** 58
 - Listening to an AUX input source 58
 - Adjusting the AUX input level 58
- Clock adjustment** 59
- Timer operation** 60
 - Setting the O.T.T. timer 60
 - Setting an everyday timer program 61
 - Sleep timer 63

Knowledge section

- Important Items** 64
 - Maintenance 64
 - Reference 66
- In case of difficulty** 67
- ⚠ **Specifications** 71



Special features

CD → MD high-speed (2x-speed) dubbing

A convenient feature enabling dubbing from CD to MD with simple operation and short period. (Applicable only to CD all-track recording)

CD text information display

When discs conforming to CD-TEXT are played with this unit, the text information recorded on the CD (disc name or titles) is displayed automatically. → 21

Some CDs conforming to CD-TEXT may not display text information.

Up to 1000 letters may be displayed. If the CD exceeds 1000 letters, "TEXT MEMORY FULL" will be displayed.

Convenient recording features

Versatile recording features are provided, allowing the user to select desired one for each purpose.

- One-touch recording: Pressing a single key starts recording of all tracks or a single track in a CD. → 41
- TWIN recording : Simultaneous recording of CD playback onto both MD and tape. → 42
- Program recording : Your favorite tracks can be recorded in any desired order. → 43

Convenient timer features

In addition to the 2-program timer, the timer also provides the following convenient features.

- AI timer : When timer playback starts, the volume level increases gradually until a certain level is reached. → 61
- O.T.T. : Timer playback which occurs only once and only for an hour can be programmed by simply setting the start time. → 60
- Sleep timer : Power of the unit can be switched off automatically after the set time has elapsed. Designed for example for falling asleep while listening to music in the night time, etc. → 63

O.T.T.(Operate easy-To-use Timer)

In regard to demonstration

This unit is equipped with a demonstration function (only display). The demonstration consists of sequential change of display and indicators showing the operations, but the audio itself does not change. The demonstration function can be cancelled as follows.

DEMO OFF (To cancel demonstration):

Press the **set/demo** key when DEMO is ON.

DEMO ON (To execute demonstration):

After turning power ON, press and hold the **set/demo** key (for more than 2 seconds).

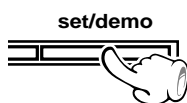

- This operates automatically when a power failure has occurred or the plug of the power cable has been pulled while the power was ON.

Unpacking

Unpack the unit carefully and make sure that all accessories are put aside so they will not be lost. Examine the unit for any possibility of shipping damage. If your unit is damaged or fails to operate, notify your dealer immediately. If your unit was shipped to you directly, notify the shipping company without delay. Only the consignee (the person or company receiving the unit) can file a claim against the carrier for shipping damage. We recommend that you retain the original carton and packing materials for use should you transport or ship the unit in the future.

Keep this manual handy for future reference.

Accessories

Please confirm that the following accessories are present.

Remote control unit (1)

Europe and U.K

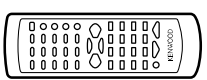

Other countries

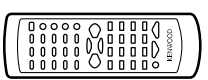

FM indoor antenna (1)

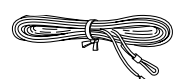

AM loop antenna (1)

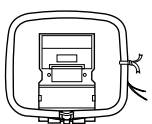

Batteries (R6/AA) (2)

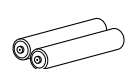

Connection of the System Accessories

This figure shows the method of connection between the main unit and provided accessories.

CAUTION Note on Connection

Connect the components as shown in the diagram.
Only plug the power cord into a power outlet once connections are completed.

Malfunction of microcomputer

If operation is not possible or erroneous display appears even though all connections have been made properly, reset the microcomputer referring to "In case of difficulty". → 67

AM loop antenna

The supplied antenna is for indoor use. Place it as far as possible from the main system, TV set, speaker cords and power cord, and set it to a direction which provides the best reception.

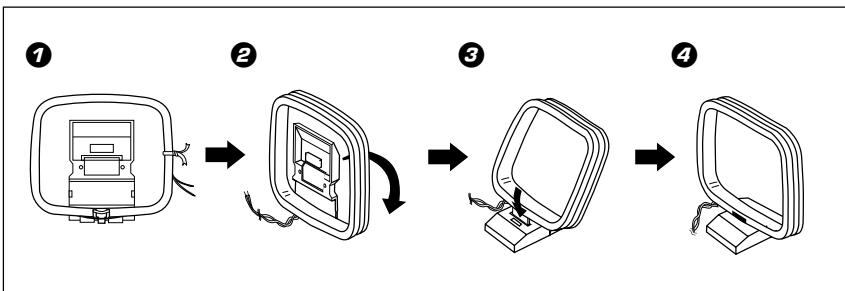

AM loop antenna



Speaker (Right)

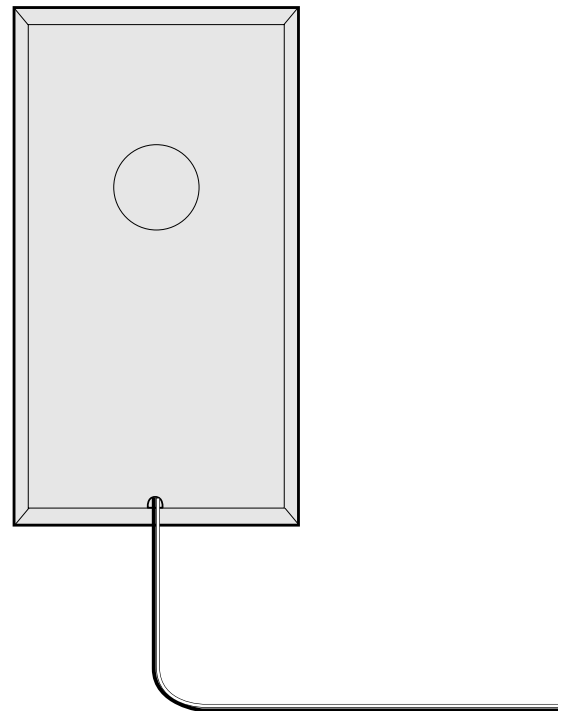

1. Never short-circuit the "+" and "-" speaker cords.
2. If the "+" and "-" polarity are inverted, the sound will be unnatural with unclear positioning of musical instruments, etc.
3. Be sure to insert all connection cords securely. If their connections are imperfect, the sound may not be produced or noise may interfere.
4. Before plugging or unplugging a connection cord, be sure to unplug the power cord from the wall AC outlet. If connection cords are plugged or unplugged with the power cord left plugged in, malfunction or damage may result.

Main Unit

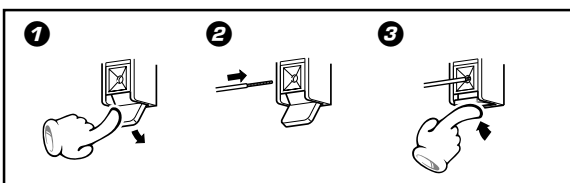

CAUTION
 Be sure to adhere followings. Or proper ventilation will be blocked causing damage or fire hazard.

- Do not place any objects impairing heat radiation onto the top of unit.
- Leave a space around the unit (from the largest outside dimension including projection) equal or greater than, shown below.

Top panel : 50 cm Back panel : 10 cm

CAUTION
 Be sure to adhere followings. Or proper ventilation will be blocked causing damage or fire hazard.

- Do not place any objects impairing heat radiation onto the top of unit.

FM indoor antenna

The accessory antenna is for temporary indoor use only. For stable signal reception we recommend using an outdoor antenna. Remove the indoor antenna if you connect one outdoors.

- 1 Connect the antenna to the antenna terminal.
- 2 Locate the position providing good reception condition.
- 3 Fix the antenna.

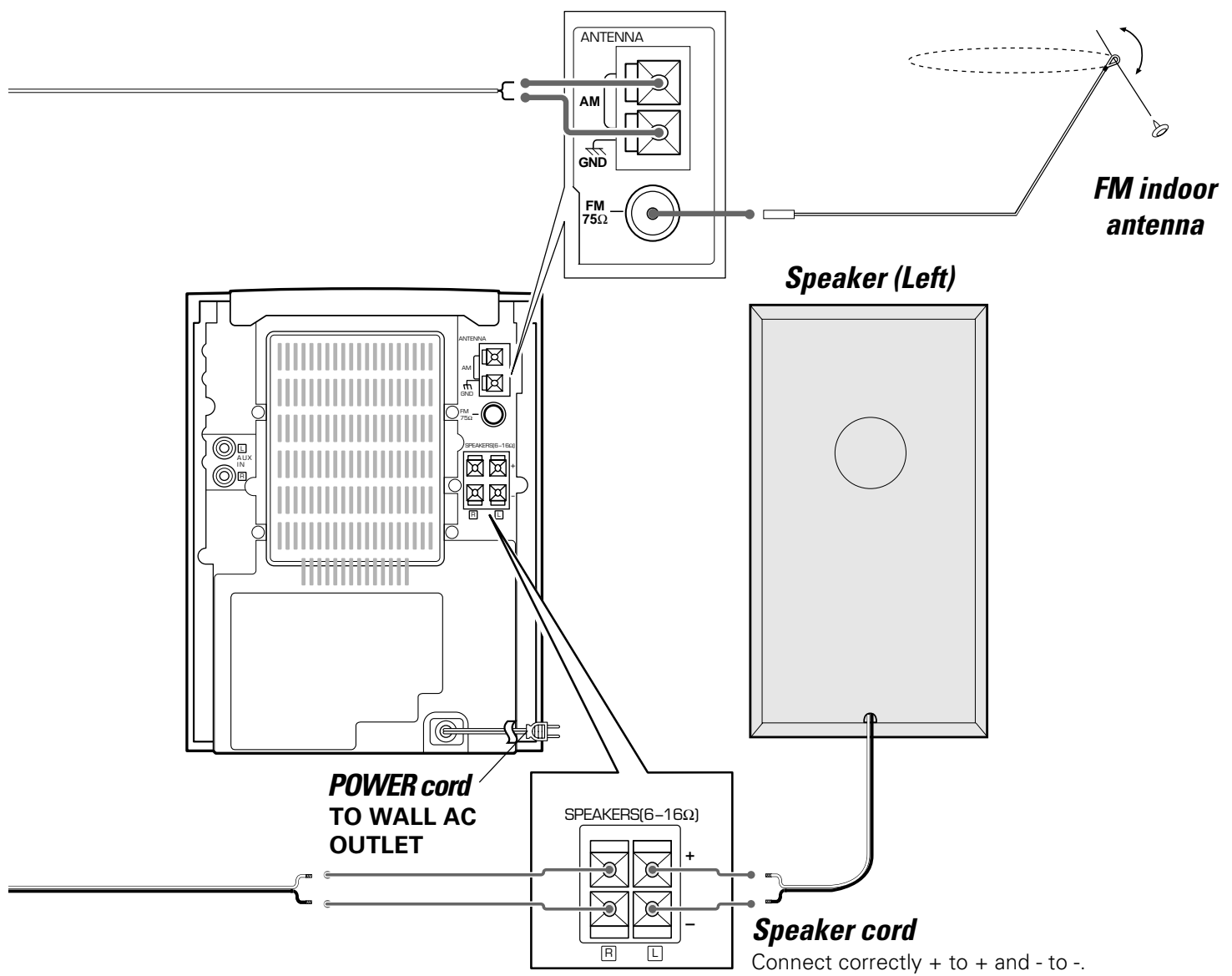

Connection of Other Accessories (Commercially Available Parts)

CAUTION Note on Connection
 Connect the components as shown in the diagram.
 Only plug the power cord into a power outlet once
 connections are completed.

FM outdoor antenna

Lead the 75Ω coaxial cable connected to the FM outdoor antenna into the room and connect it to the FM 75Ω terminal. Please remove the indoor antenna after an outdoor antenna has been installed.

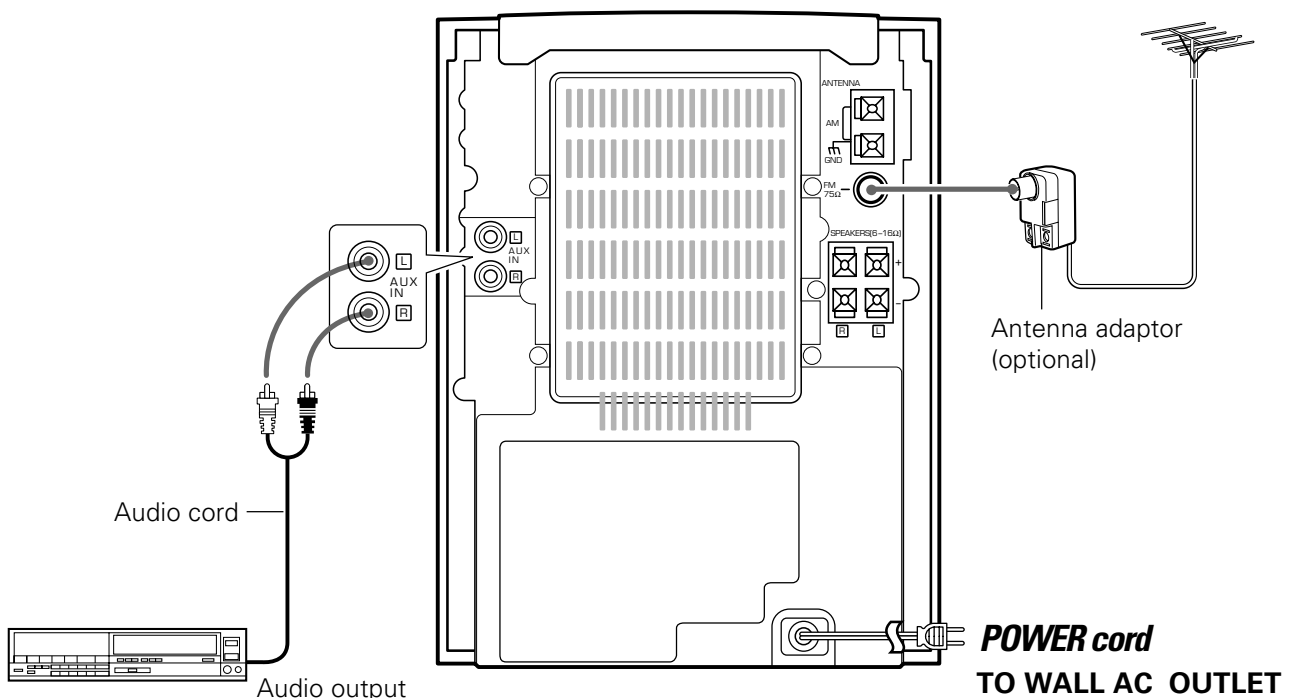

VCR, Analog turntable with built-in
 RIAA equalizer (optional P-110), etc.



1. In case an associated system component is connected, also read the instruction manual of the component.
2. Be sure to insert all connection cords securely. If their connections are imperfect, the sound may not be produced or noise may interfere.
3. Before plugging or unplugging a connection cord, be sure to unplug the power cord from the wall AC outlet. If connection cords are plugged or unplugged with the power cord left plugged in, malfunction or damage may result.

Display

(The displays given in this manual are approximations only. They may differ from what actually appears on the display.)

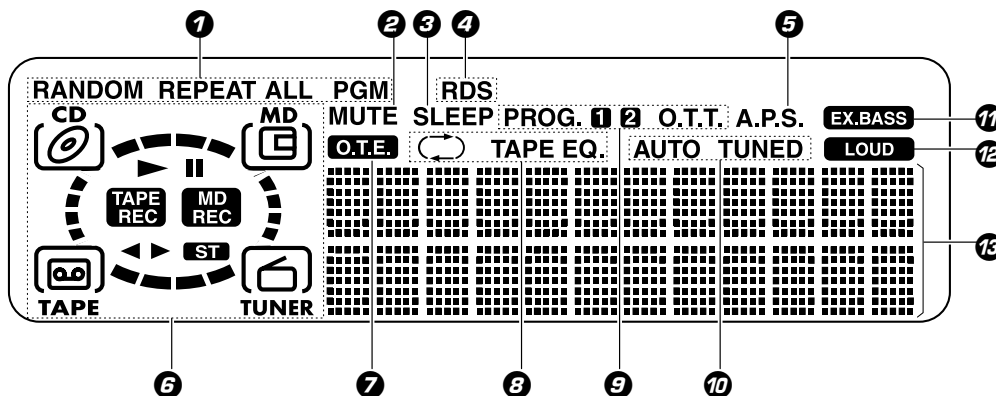

- ❶ Indication related to CD/MD
- ❷ MUTE indicator
- ❸ SLEEP indicator
- ❹ RDS indicator (except for some areas)
- ❺ Auto Power Save indicator
- ❻ Selected selector indicator
- ❼ O.T.E. (ONE TOUCH EDIT) indication
Appears during one-touch recording.
- ❽ Reverse mode and TAPE equalizer (TAPE EQ.) indicators

- ❾ Timer-related indicators
- ❿ Tuner-related indicators
- ⓫ EX.BASS indication
- ⓬ LOUD (Loudness) indication
- ⓭ Character information display section

Shows character information including the input selection, volume level and disc/track title. Frequency indication, time indication, track No., program No., etc.

Preparation section

Display panel control

Controlling the BACK LIGHT

The brightness of the main unit display can be adjusted.

- ❶ Turn power ON and press the menu key.



- ❷ Rotate the volume/multi control knob to select "BACK LIGHT?" and press the set/demo key.

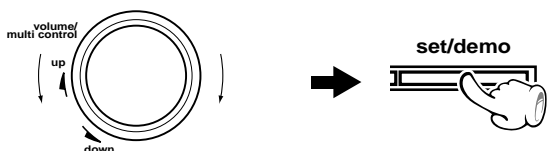

- ❸ Rotate the volume/multi control knob to select the desired light brightness ("High" or "Low") and press the set/demo key.

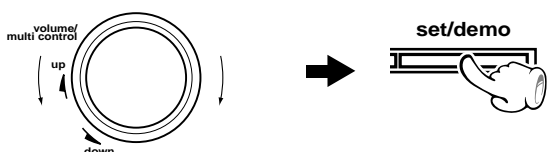

- When the SLEEP timer has been set, the light is "Low" regardless of the BACK LIGHT setting.

AUTO POWER SAVE function

When the unit is ON and the unit is left for 30 minutes with CD, MD and TAPE not operating, the unit is switched off automatically by this function. This is convenient when you forgot to switch off the unit. This function can be activated or deactivated by the following operation.

- ❶ Select "A.P.S. SET?".



(Press the set/demo key while the "?" mark is blinking.)

- ❷ Select.

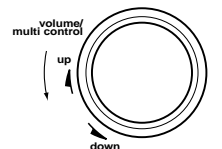

- ❸ Set it.



- When the TUNER or AUX input is selected, APS operates only when the volume is set to zero or when MUTE is on.

Main unit

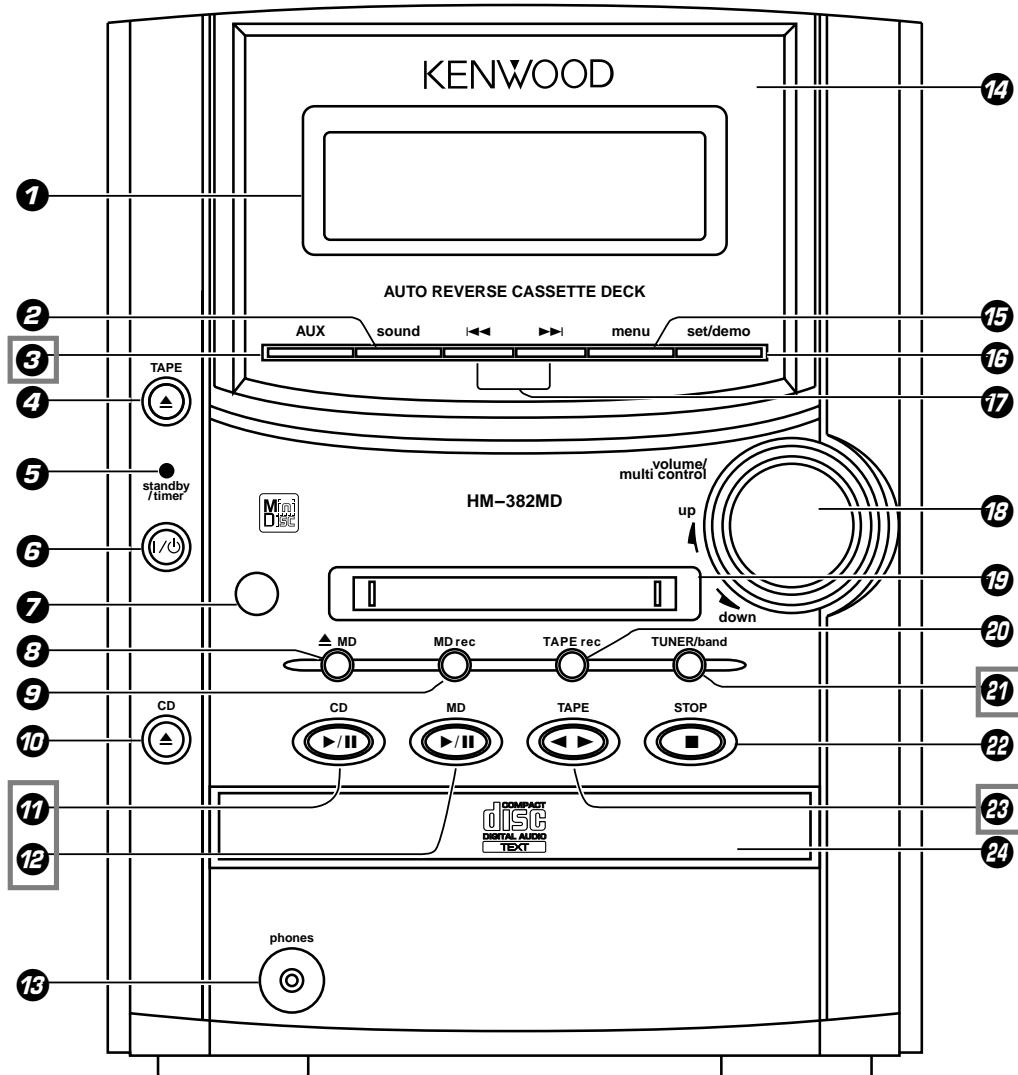

About the one-touch operation function

This unit incorporates the one-touch operation function for the user's convenience. With this function, pressing any key enclosed in while the unit is in standby mode immediately start playback (or reception).

- 1 Display** → 15
- 2 sound key** → 15
Used for switching the EX.BASS play and LOUDNESS play.
- 3 AUX key** → 58
Press to listen to the input source connected to AUX (analog external).
- 4 TAPE key** → 22
Press to open or close the cassette holder.
- 5 Standby / timer indicator**
Light in standby mode of power.
Red : Normal standby mode
Amber : Timer standby
Extinguished : Power off
- 6 POWER(|/⏻) key** → 14
- 7 Remote sensor** → 13
- 8 ▲MD key** → 47
This key is pressed to remove disc.
- 9 MD rec key** → 29
- 10 CD key** → 16
Press to open or close the CD tray.
- 11 CD▶/|| key** → 16
Press to select the CD input and start CD playback.
Press during CD playback to let it pause temporarily.
- 12 MD▶/|| key** → 18
Press to select the MD input and start MD playback.
Press during MD playback to let it pause temporarily.
Press during MD recording to let it pause temporarily.
- 13 phones jack** → 15
Headphones with a stereo mini plug (optional) can be connected.
- 14 Cassette holder**
Press the TAPE key to open or close.

- 15 menu key**
Press to switch the function of the **volume/multi control** knob.
This key is also used when setting the time of the day. → 59
- 16 set/demo key**
Press to set or enter an item selected with the **volume/multi control** knob. → 23 → 57 → 4
- 17 Skip/search (◀◀/▶▶) keys**
During CD or MD operation : → 17 → 19
Press to skip tracks in the forward or backward direction.
During TAPE operation : → 23
Press to search in the forward or backward direction.
During TUNER operation : → 24
Press to receive a preset station.
These keys are also used during MD editing, track number selection and title character selection. → 53
- * 18 volume/multi control knob** → 11
Normally this is used for volume adjustment.
- 19 Mini Disc insertion slot** → 31
- 20 TAPE rec key** → 31
Press to start recording. Pressing the key during recording stops it after leaving a non-recorded space (blank) of about 4 seconds.
- 21 TUNER/band key** → 24
The received broadcasting band is switched.
Press to select the TUNER input.
- 22 ■STOP key**
Press in power standby mode to display the clock.
- 23 TAPE◀▶ keys** → 22
Press to select the cassette TAPE input and play a tape.
Press during playback to change the tape transport direction.
- 24 CD tray**
Press the CD key to open or close.

*** About the volume/multi control knob**

After selecting the function of this knob with the menu key, select the desired control item by turning the volume/multi control knob.
To set or enter the setting of the selected item, press the set/demo key.

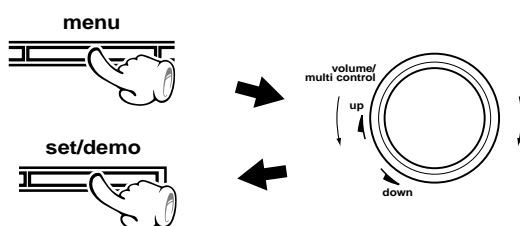

Turning the knob switches the display contents.

- TAPE RVS. ? → 23
- REC. MODE ? → 40
- A.MEMORY (or AUTO PRESET ?)
(Only when the TUNER input is selected) → 26
- AUX INPUT ? → 58
(Only when the AUX input is selected)
- BALANCE ? → 57
- BACK LIGHT ? → 9
- A.P.S. SET ? → 9
- TIMER SET ? → 60

● The function of the control knob returns to the normal mode when it has not been operated for 20 seconds.

The keys on the remote control unit with the same names as on the main unit have the same function as the keys on the main unit.

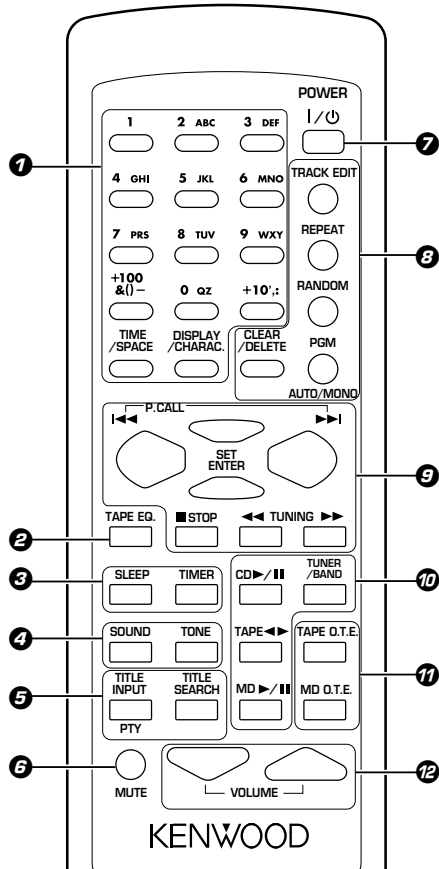

Infrared ray system
 Model : RC-M0100E (For UK and Europe)
 : RC-M0100 (For other countries)

① Character/numeric keys

These are used to select CD or MD tracks and as preset call keys for the tuner. → 17 - 19 - 25

Used to enter alphanumeric and symbol characters in the MD title input operation. → 52

TIME/SPACE key

Press to switch the time information displayed during CD or MD playback. → 17 - 19

Press to enter a space during MD title entry. → 52

DISPLAY/CHARAC. key

This key switches the display mode of the dot display. → 21

Press to switch the character type during MD title entry. → 52

② TAPE EQ. key

Press to switch the tape equalizer on.

③ SLEEP key

This is used to set the sleep timer.

TIMER key

Used to select the timer.

④ SOUND key

Used for switching the EX.BASS play and LOUDNESS play.

TONE key

This is used to adjust the tone.

⑤ TITLE SEARCH key

This is used in searching an MD title.

TITLE INPUT key

This is used in MD title input operation.

RDS-related keys (Only some areas)

PTY key

Used at the time of program type detection.

⑥ MUTE key

This is used to suppress the sound temporarily.

⑦ POWER (I/O) key

The system is switched ON and STANDBY.

⑧ Keys related to CD and MD

(Common keys for CD and MD function for CD or MD according to the input selection.)

TRACK EDIT key

This is used in MD editing for reordering tracks, deleting tracks, etc. → 46

REPEAT key

This is used for repeated playback. → 33

RANDOM key

Playback of the CD tracks in random order. → 34

PGM/AUTO/MONO key

This is used to program the track sequence. → 32

During TUNER operation:

Used to switch the tuning mode between "AUTO" (auto tuning, stereo reception) and MONO (manual tuning, monoaural reception). → 25

CLEAR/DELETE key

The programmed track sequence is cleared. → 32

At the time of character input, characters are deleted. → 54

④ Basic operation keys

◀◀P.CALL▶▶ keys

During CD or MD operation: → 17 → 19
 Press to skip tracks in the forward or backward direction. These keys are used in MD editing, input character selection.

During TAPE operation : → 23
 Press to select a preset station. Press during TAPE operation to fast forward or fast reverse the tape.

During TUNER operation: → 24
 Press to select a preset station.

RDS operation (Only some areas) → 36

◀◀TUNING▶▶ (Fast forward, fast reverse) keys

During CD,MD or TAPE operation: → 17 → 19 → 23
 Press to search in the forward or backward direction.

Use these to move the cursor when inputting MD titles. → 53

During TUNER operation: → 24
 Press to select a radio station.

SET key → 32 → 46 → 51
 This is used to set an MD editing operation or to set or enter

the item selected with the "volume/multi control" knob.
ENTER key

This is used to execute an MD editing operation or to enter an input title. → 47 → 54
 It is also used to enter the preset station memory in the tuner. → 25

■STOP key

⑩ TAPE ◀▶ key

MD▶/|| key

CD▶/|| key

TUNER/band key

⑪ TAPE O.T.E. key/ MD O.T.E. key → 41

These keys are used for recording of a CD onto tape or MD with a one-touch operation. Press either key during CD playback to record the currently played track onto tape or MD. Press in stop mode to record the entire CD onto tape or MD.

⑫ VOLUME control keys

Press to control the volume. → 14
 Press to control the tone. → 57

Loading batteries

① Remove the cover.

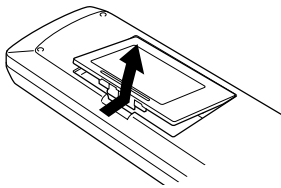

② Insert batteries.

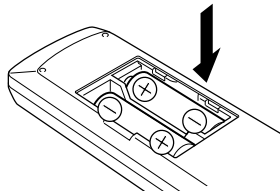

③ Close the cover.

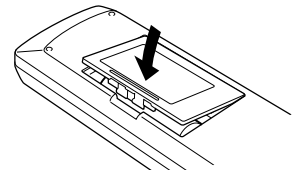

- Insert two R6 ("AA"-size) batteries following the polarity indications.

Operation

After plugging the power cord of this unit, press the **POWER (I/⏻)** key of the remote control unit to turn the system ON. When the system is turned ON, press the key of the function to be operated.

- When pressing more than one remote control keys successively, press the keys securely by leaving an interval of 1 second or more between keys.

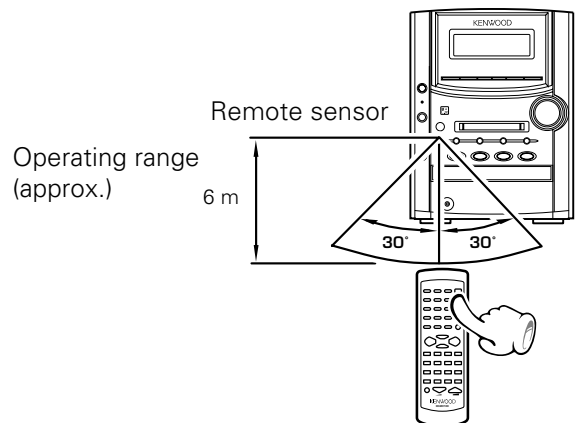

1. The provided batteries are intended for use in operation checking, and their service life may be short.
2. When the remote controllable distance becomes short, replace both of the batteries with new ones.
3. If direct sunlight or the light of a high-frequency fluorescent lamp (inverter type, etc.) is incident to the remote sensor, malfunction may occur. In such a case, change the installation position to avoid malfunction.

Bass and treble compensation

The system is switched ON and STANDBY

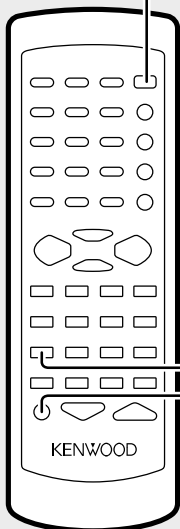

Muting the sound temporarily

Bass and treble compensation

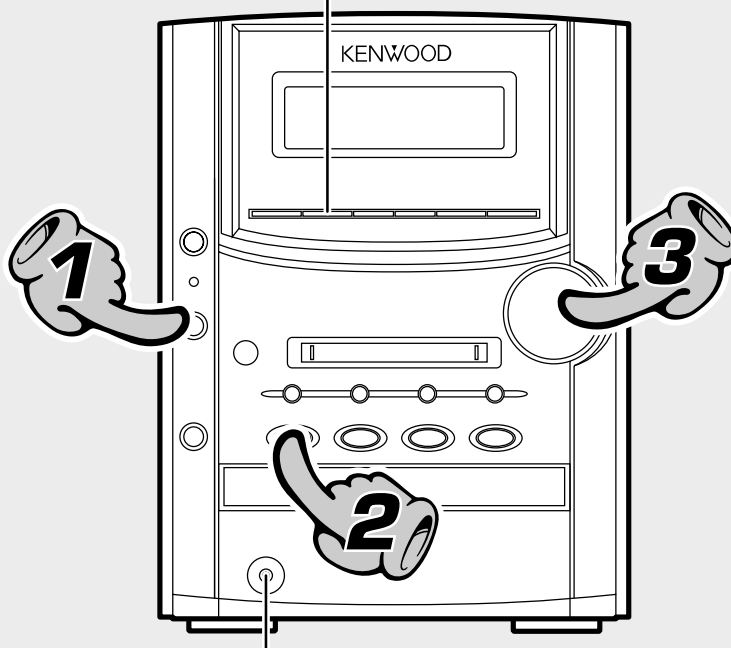

Listening through headphones



1. Set the POWER (I / ⏻) key to ON.

When the POWER (I / ⏻) key is pressed while the unit is ON switches it OFF. The standby/timer indicator lights red or amber.

- Pressing the CD ▶/||, MD ▶/||, AUX, TAPE ◀▶ or TUNER/band key also turns power on and starts playback (reception) of the corresponding input. (One-touch operation)
- When the CD, MD or TAPE input is selected while the corresponding disc or tape has been loaded, it immediately starts to play.

Example:
To select the CD input



2. Selecting the desired output.

CD	→ 16
MD	→ 18
TAPE	→ 22
TUNER (Broadcasts)	→ 24
AUX (External input)	→ 58
"Adjusting the AUX input level"	→ 58

- Pressing the CD ▶/||, MD ▶/||, AUX, TAPE ◀▶ or TUNER/band key selects the corresponding input.

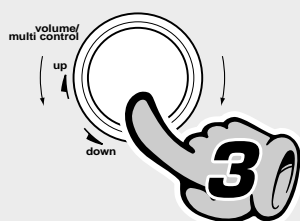

3. Volume adjustment.

- The display shows a reference value.

The volume decreases

The volume increases

Listening through headphones

Insert the headphone plug into the "phones" jack.

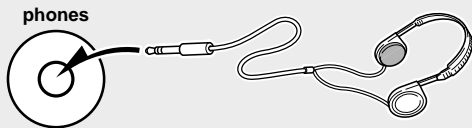

- Headphones with a stereo mini plug can be connected.
- The sounds from all speakers are cut off.

Muting the sound temporarily (Remote control unit only)



- Press again to resume the original volume.
- This is also cancelled when the volume is changed.

Bass and treble compensation

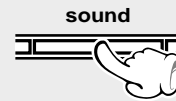

Each press switches the modes as follows.

- ① "EX.BASS" lights.
The lowest and highest frequencies are enhanced regardless of the current volume level.
- ② "LOUD" (Loudness) lights.
The lowest and highest frequencies are enhanced according to the current volume level. (Effective during low-volume listening.)
- ③ Both indicators off.
Canceled.

- Adjusting the tone while the "LOUD" or "EX.BASS" indicator is lit turns it off and cancels the sound enhancement mode. → 57

Standby mode

While the standby/timer indicator of the unit is lit in red or amber, a small amount of current flows to back up the memory. This condition is called standby mode.

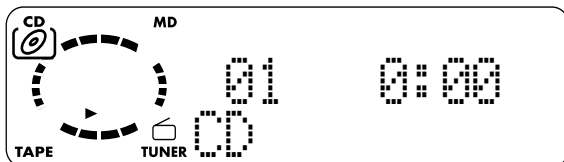

When CD has been selected.

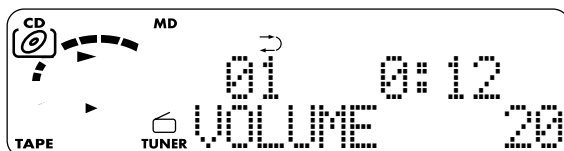

Volume display



When a disc is placed into the CD player in advance, the unit will be switched on automatically by pressing the CD ►/|| key, and playback will start.

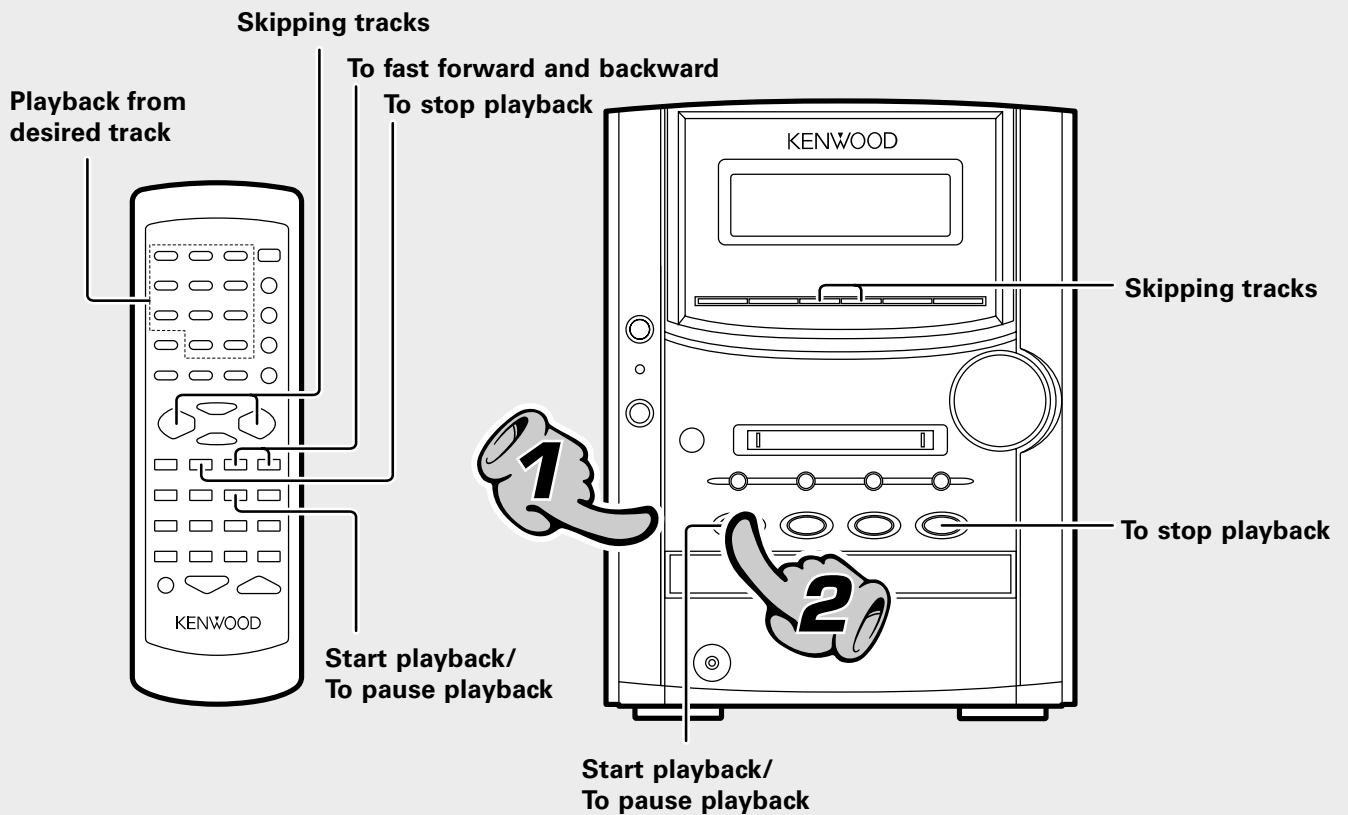

1. Load a disc.



- ① Press the CD ▲ key
- ② Place a disc.
- ③ Press the CD ▲ key

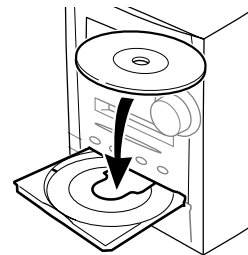

The label side must be on top.

2. Start playback.



In regard to CD-TEXT

When discs conforming to CD-TEXT are played with this unit, the text information recorded on the CD (disc name or titles) is displayed automatically. - 21

Some CDs conforming to CD-TEXT may not display text information.

Up to 1000 letters may be displayed. If the CD exceeds 1000 letters, "TEXT MEMORY FULL" will be displayed.

Skipping tracks

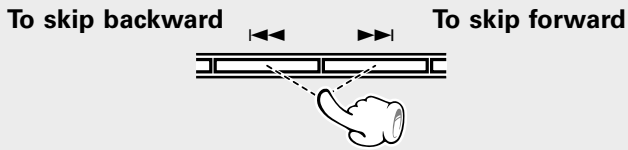

- The track in the direction of the key pressed is skipped, and the selected track will be played from the beginning.
- When the I◀◀ key is pressed once during playback, the track being played will be played from the beginning.
- Operation also is possible with the key I◀◀ and ▶▶I key of the remote control unit.

To fast forward and backward (Remote control unit only)

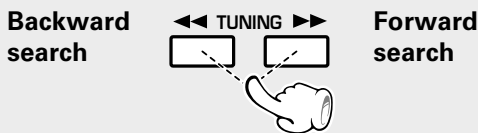

- Playback starts from the position where the key is released.

To stop playback

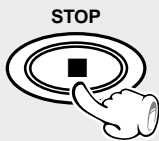

- Do not touch the played side of disc.
- Be sure to place a disc horizontally. Placing it with an inclination will result in malfunction.

Displayed when a disc is loaded.

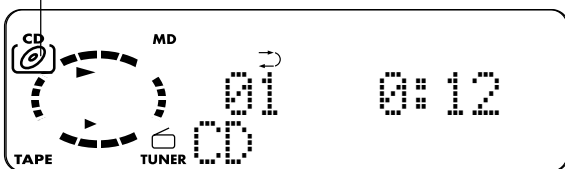

- Titles are displayed for discs conforming to CD-TEXT.
- After a few seconds, play starts from track No.1.

To pause playback



- Each press pauses and plays the CD alternately.

Playback from desired track (Remote control unit only)

Select the desired track No.

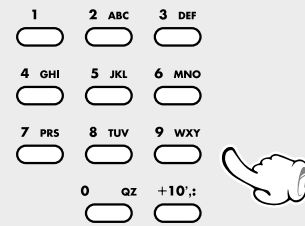

Press the numeric keys as shown below....

To select track No. 23 : [+10] [+10] [3]

To select track No. 40 : [+10] [+10] [+10] [+10] [0]

Eject the CD

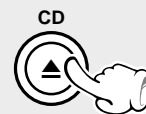

- The CD tray opens.

Time display on CD player

(Remote control unit only)

Each press of the TIME/SPACE key changes the displayed contents.

- ① 1:23 (Elapsed time of track being played)
- ② -2:37 (Remaining time of track being played)
- ③ 23:45T (Elapsed time of entire disc)
- ④ -36:15T (Remaining time on entire disc)

- Only time information ① and ② can be displayed during single-track repeated playback or random playback.



When a disc is placed into the MD recorder in advance, the unit will be switched on automatically by pressing the MD ►/II key, and playback will start.

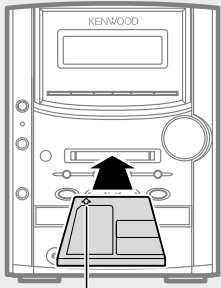
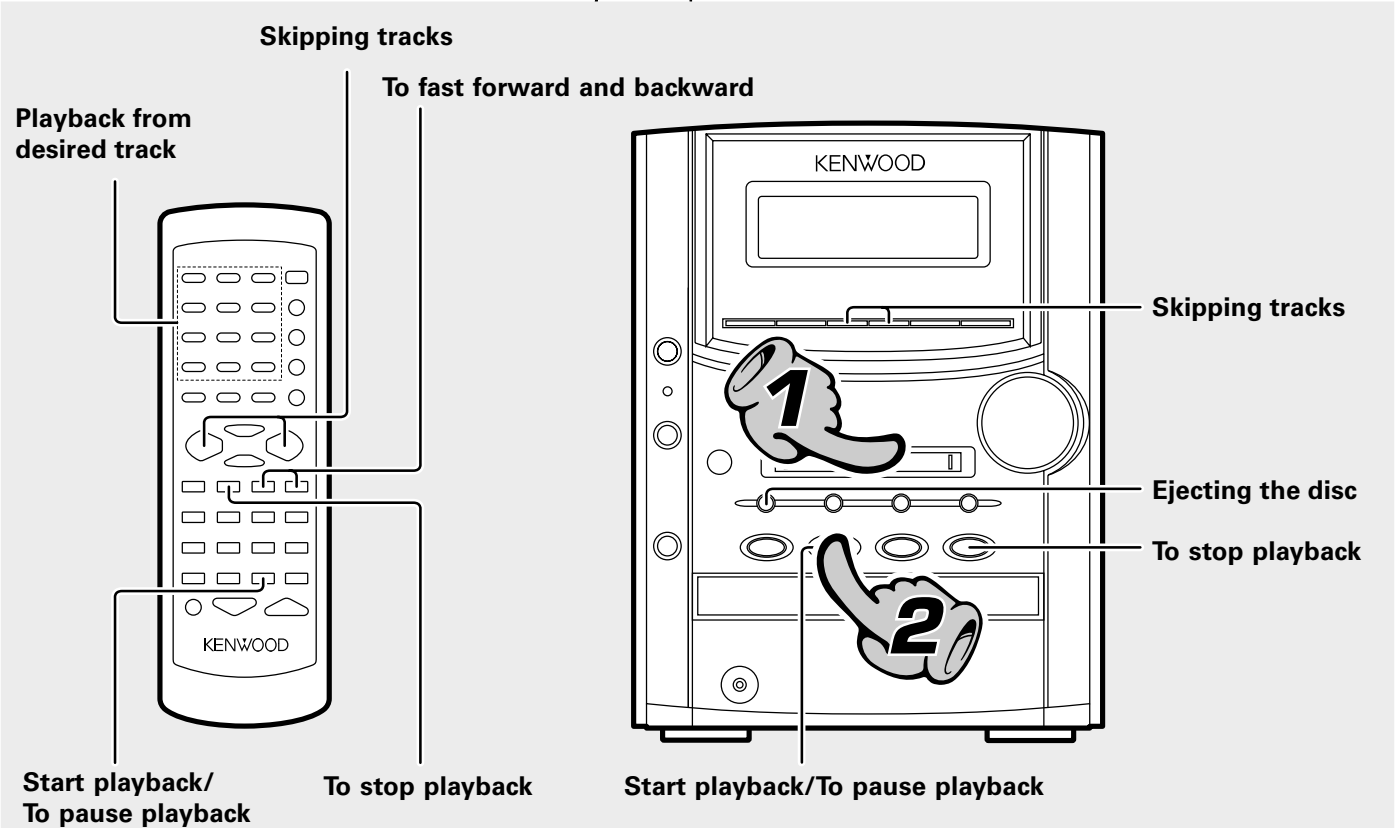

In the direction of the arrow

1. Load a Mini Disc.

Insert the minidisc correctly into the slot of this unit.

- When a title has been recorded for the disc, the title is displayed.

CAUTION

The MD cannot be loaded or ejected while the unit is in standby mode. Do not force load a MD in standby mode, otherwise malfunction will result.

2. Start playback.

- If the MD being played contains recording of track titles, the track title is displayed at the beginning of each track during playback.

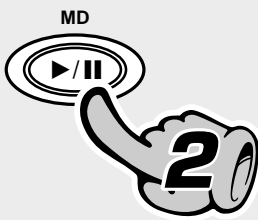

Skipping tracks

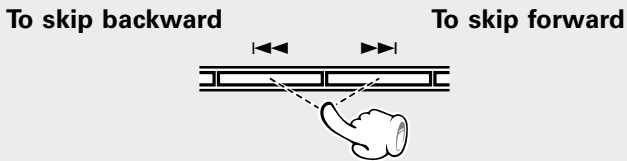

- The track in the direction of the key pressed is skipped, and the selected track will be played from the beginning.
- When the I◀◀ key is pressed once during playback, the track being played will be played from the beginning.
- Operation also is possible with the key I◀◀ and ▶▶I key of the remote control unit.

To fast forward and backward (Remote control unit only)

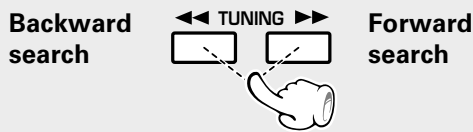

- Playback starts from the position where the key is released.

To stop playback

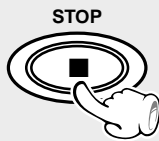

To pause playback



- Each press pauses and plays the MD alternately.

Playback from desired track (Remote control unit only)

Select the desired track No.

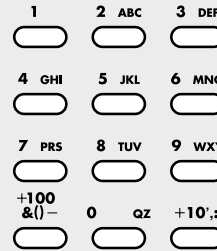

Press the numeric keys as shown below....

- To select track No. 23 : [+10] [+10] [3]
- To select track No. 40 : [+10] [+10] [+10] [+10] [0]
- To select track No. 213 : [+100] [+100] [+10] [3]

- If the "PGM" indicator is lit, stop the MD recorder and press the **PGM/AUTO/MONO** key of the remote control unit to turn the indicator off.

The display changes.

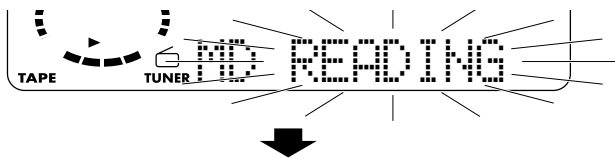

Disc title

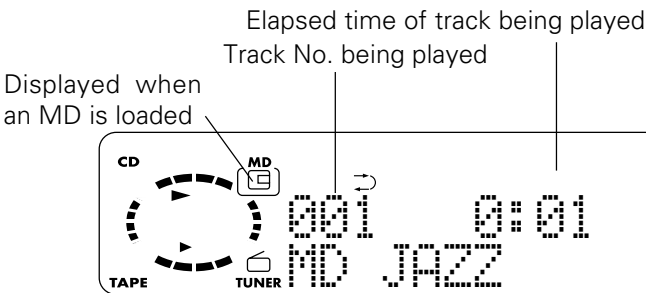

Track title

Time display on MD recorder

(Remote control unit only)

Each press of the TIME/SPACE key changes the displayed contents.

- 1:23 (Elapsed time of track being played)
- 2:37 (Remaining time of track being played)
- 23:45T (Elapsed time of entire disc)
- 36:15T (Remaining time on entire disc)
- 22:24R (Available recording time of MD)

Disc recorded in monaural mode

This unit can also play discs recorded in monaural, LP mode.

As the amount of data required to record information in the monaural mode is half the amount required in the stereo mode, the play (record) time of a disc recorded in the monaural mode is twice (max. 160 minutes) that of a disc recorded in the stereo mode.

Searching a desired track by its title (TITLE SEARCH)

When the titles of the tracks recorded on a minidisc for recording are entered in advance, search by title is possible for the tracks to be played. → 51

❶ Select the "MD" input.



❷ To stop playback.



❸ Press the TITLE SEARCH key.



(To abort operation, press the TITLE SEARCH key again)

❹ Select the desired title.

To smaller track No. To larger track No.

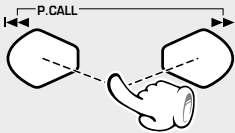

❺ Start playback.



- When the "PGM" indicator is lit, press the **PGM/AUTO/MONO** key on the remote control unit to switch it off.

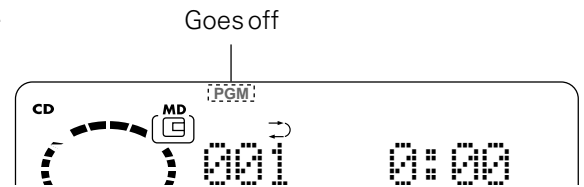

- With a track to which no title has been assigned, the track number and "....." are displayed.
- Track selection is possible with the ◀◀ or ▶▶ key of the main unit.

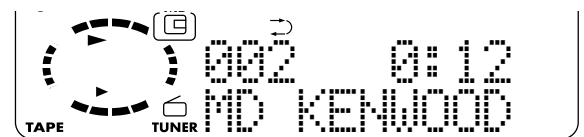
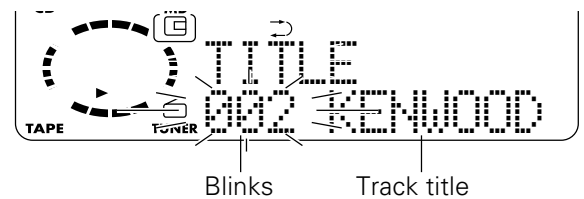

In regard to the DISPLAY/CHARAC. key

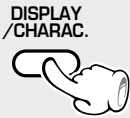

When a title recorded in a CD-TEXT or MD disc is too long to be displayed in the display, press this key to scroll the display and view the characters which has not be displayed.

With a CD-TEXT or MD disc

Pressing the key during stop scrolls the disc title.



Pressing the key during playback scrolls the track title.



During simultaneous MD/Tape recording

Each press switches the information.

① Available recording time of MD



② Tape counter display.



- When no track name (track title) and no disc name (disc title) has been recorded, " ●●●●● " is displayed.
- "BLANK DISC" is displayed when not even one track has been recorded. (When there is a disc title, the disc title will be displayed.)



If you load a tape in the cassette deck in advance while the power is off, pressing the TAPE ◀▶ key turns power on automatically and starts the tape playback.

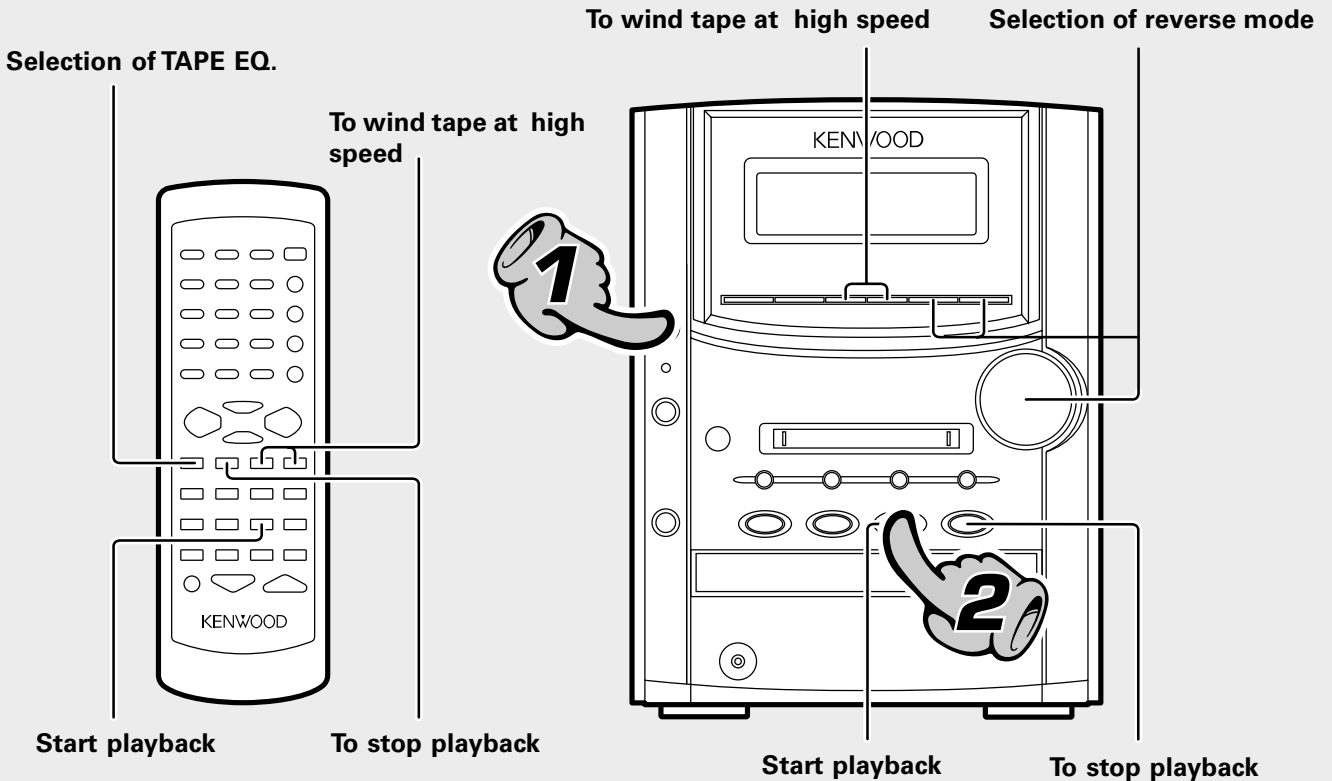

Basic section

1. Load a cassette tape.



- ① Press the TAPE ▲ key.
- ② Insert a tape.
- ③ Press the TAPE ▲ key.

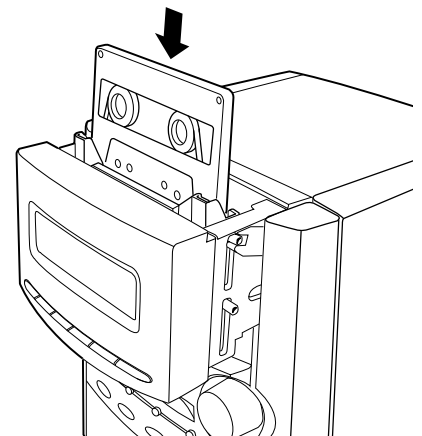

2. Start playback.

Transport direction indicators



During playback, the tape running direction changes each time the key is pressed.

Transport direction indicators

Indicates the tape transport direction during playback or recording by lighting of ◀ or ▶. This direction is the direction stored in memory when the tape was last stopped.

To wind tape at high speed

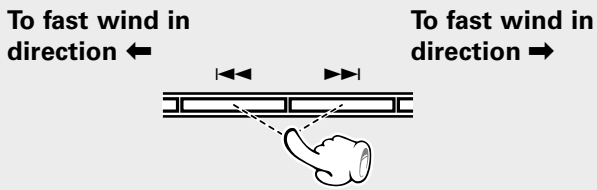

- Press the ■STOP key to stop fast winding.

Selection of TAPE equalizer (TAPE EQ.)

(Remote control unit only)

When playing a tape prerecorded with Noise Reduction system (such as the DOLBY NR) ON, be sure to set the "TAPE EQ." ON for playback.



Each press switches the modes as follows.

- ① "TAPE EQ." ON TAPE equalizer is used.
- ② "TAPE EQ." OFF TAPE equalizer is not used.

- Select the "TAPE EQ." ON mode according to the recording condition of the tape.

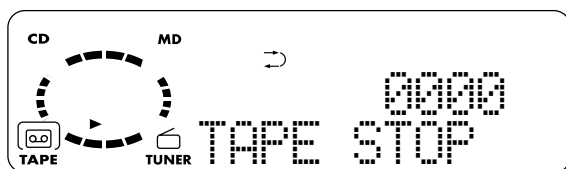

- Normal (TYPE I), high (TYPE II), or metal (TYPE IV) tape selection is set automatically.
- Remove tape slack before loading.

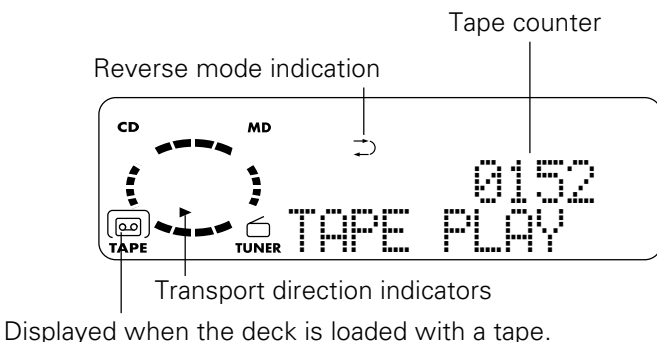

Displayed when the deck is loaded with a tape.

To stop playback

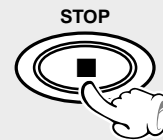

Selection of reverse mode (Main unit only)

- ① Select "TAPE RVS. ?".

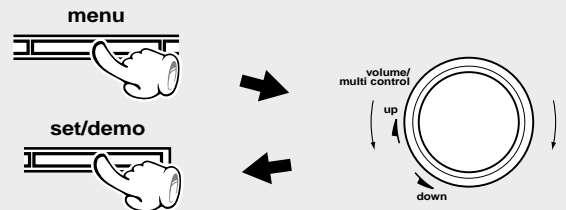

(Press the set/demo key while the "?" mark is blinking.)

- ② Select.

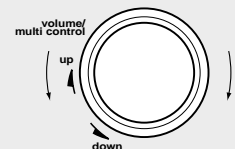

- ① "↶": (REVERSE)
Both sides are played back (recorded), and then the tape stops.
- ② "↷": (ENDLESS)
Both sides are played back endlessly.
(The tape stops after recording onto both sides.)
- ③ "↷": (ONE-WAY)
Only one side is played back (recorded), and then the tape stops.

(The initial setting is "↶" (REVERSE).

- ③ Set it.



A tip for use of the tape counter

The tape counter is set to "0000" when a cassette tape is loaded. By writing down the counter reading in case you want to interrupt recording (playback) in the middle of the tape, the memo will be helpful as a reference for locating the same position when continuing the recording (playback) the next time. The tape counter figure decrements during recording or playback of the back side (while the ◀ tape transport indicator is lit). To set the tape counter to "0000", open the cassette holder once. Then the counter will be reset.

Do not use a cassette with more than 90-minute recording time, for the tape used with such a cassette is very thin and tends to cause troubles such as entanglement around the pinch roller or cutting of tape.

Up to 40 radio stations can be preset in memory.



When the "TUNER/band" key is pressed, the unit will automatically be switched on and reception status will be reached.

Auto/manual station switching

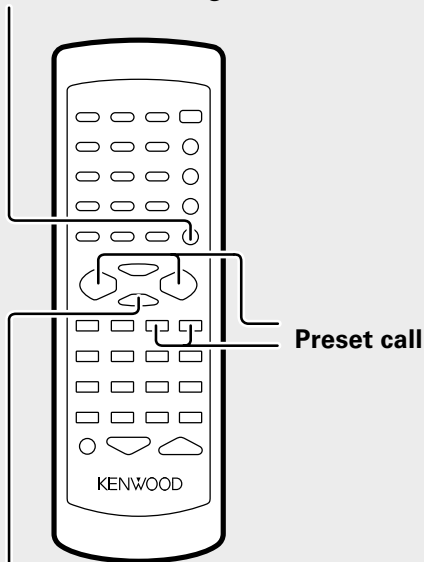

One-by-one presetting

Collective presetting of stations

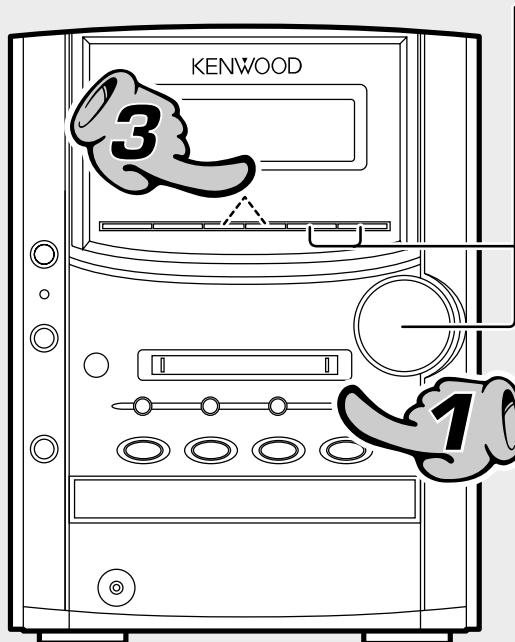

Basic section

TUNER/band



1. Press the tuner/band key.

Preset a radio station in memory.

- ① FM
- ② AM

2. Preset a radio station in memory (auto preset).

Follow the procedure in "Collective presetting of stations (auto preset)" to preset automatically the tunable radio stations in your area. → 26

- Once stations are stored by auto preset, the present procedure is not required from the next time, unless you move of house or re-execute presetting of all tunable stations.

3. Tuning (Preset Call)

- If radio stations have already been stored with auto preset or manual preset, select a station using the **◀◀P.CALL▶▶** key. Each press of the same key switches the preset stations in sequence.
 When ▶▶ is pressed: 1→2→3 ... 38→39→40→1...
 When ◀◀ is pressed: 40→39→38 ... 3→2→1→40...
- To select a preset station from the remote, use the **◀◀P.CALL▶▶** key or numeric keys.

When no stations have been memorized

Auto tuning : The next broadcasting station will be received automatically each time this key is pressed.

Manual tuning : Press the **◀◀TUNING▶▶** key repeatedly until a station is received. Or hold either key and release it when the frequency of the desired station is received.

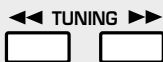
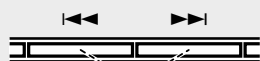

One-by-one presetting (manual preset)

① Press the ENTER key during reception.



(Proceed to step ② while "MEMORY" is lit.)

② Select one of the preset numbers from 1 to 40.

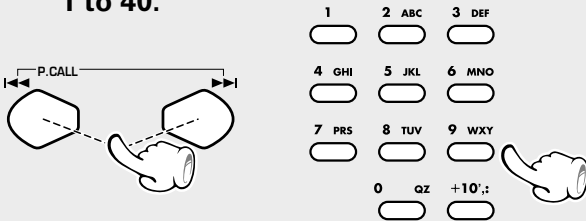

③ Press the ENTER key again.



(Repeat steps ①, ②, ③ to preset other stations)

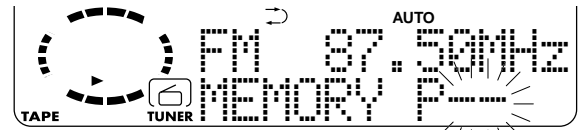

"MEMORY" lights (for approx. 20 sec.)

- A maximum of 40 stations of the band presently being received will be preset.

- If several stations are preset under the same number, the previous memory is replaced with the latest memory contents.

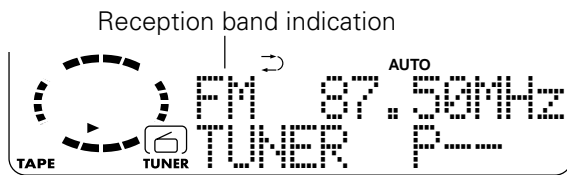
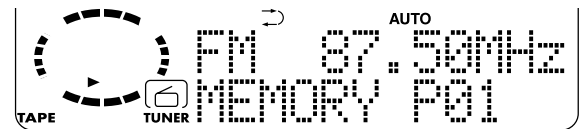

Tuning mode switching and reception mode (Remote control unit only)



Each press alternates the mode.

- ① "AUTO" lit (Auto tuning, stereo reception)
- ② "AUTO" not lit (Manual tuning, monaural reception)

Use the manual tuning mode when reception is noisy due to weak reception. (In the manual mode, stereo broadcasts are received in monaural.)

- Normally, use the **AUTO** (Auto tuning, stereo reception) mode.

The "TUNED" indicator lights when a station is received.

Lights at the time of automatic station selection.

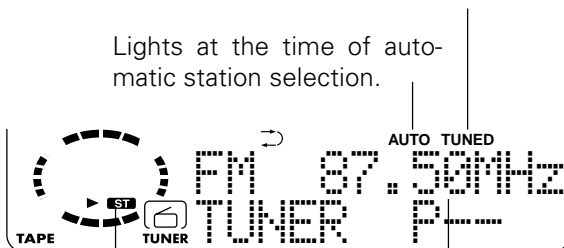

Lights during stereo reception Frequency display

- When a key is held depressed, preset stations will be skipped at an interval of about 0.5 second.
- Preset stations can be called using the number keys on the remote control unit.

Collective presetting of stations

AUTO MEMORY For U.K. and Europe
AUTO PRESET Other countries

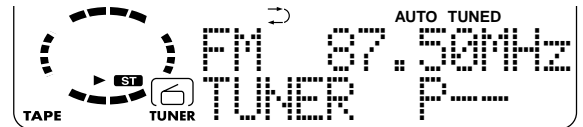
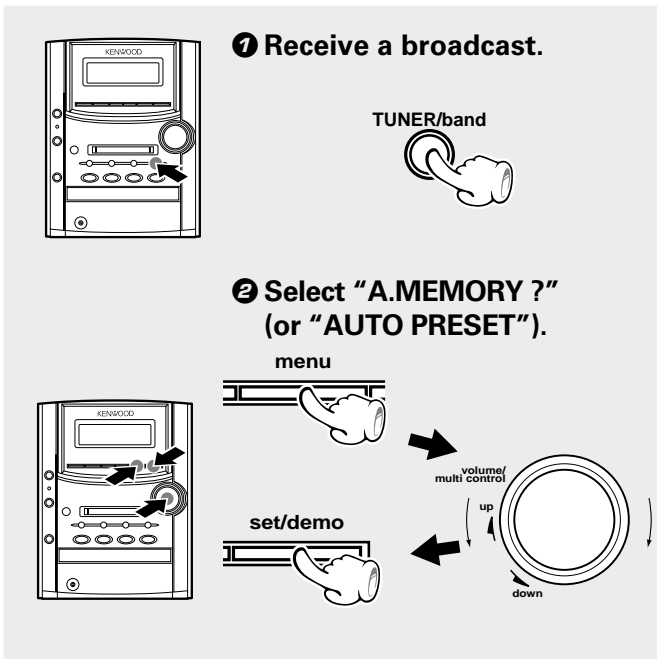

- A maximum of 40 stations of the band presently being received will be preset.
- When there are many stations and the intended station has not been preset, please also use **"One-by-one presetting (manual preset)"**.

Basic section

Channel space setting

(Except for the United Kingdom)

The space between radio channels has been set to the one that prevails in the area to which the system is shipped. However, if the current channel space setting does not match the setting in the area where the system is to be used, for instance when you move from area 1 or area 2 shown in the following table or vice versa, proper reception of AM/FM broadcasts cannot be expected. In this case, change the channel space setting in accordance with your area by referring to the following table.

Area		CHANNEL Space Frequency
1	USA, Canada and South American countries	FM: 100 kHz AM: 10 kHz
2	Other countries	FM: 50 kHz AM: 9 kHz

- 1 Turn power on.
- 2 Press the TUNER/band key.
- 3 Press the ■STOP key. (for more than 5 seconds)
- 4 Select the mode by using the ■STOP key.

Each press switches the space frequency alternately.

- 1 "FM 50 kHz" (FM 50 kHz, AM 9 kHz)
- 2 "FM 100 kHz" (FM 100 kHz, AM 10 kHz)

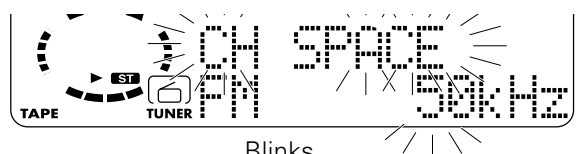

- 5 Establish the selection by pressing the set/demo key.

This unit cannot record audio in monaural, LP mode.

MD recording is possible as "digital recording", where the digital signal of the CD is used as it is, and as "analog recording", where the analog signal of a broadcast etc. is converted to a digital signal.

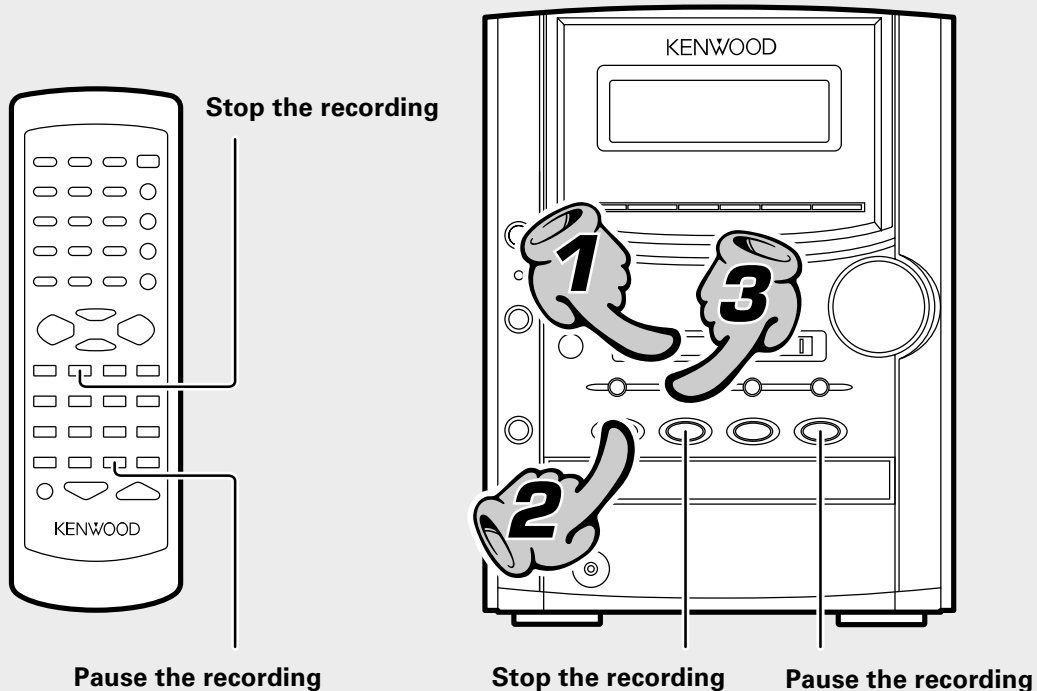

Pause the recording

Stop the recording

Pause the recording

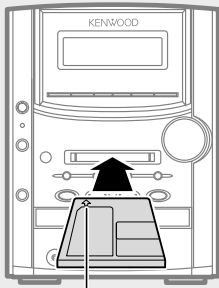

In the direction of the arrow

1. Make the preparations for recording.

- 1 Open the write protect tab of the Mini Disc to make it recordable.

→ 65

- 2 Load the Mini Disc.

CAUTION

The MD cannot be loaded or ejected while the unit is in standby mode. Do not force load a MD in standby mode, otherwise malfunction will result.

2. Select the source to be recorded.

Select an input source other than "MD"

Example:
To select the CD input



- CD : Only digital recording
- TAPE : Only analog recording
- TUNER (Broadcasts) : Only analog recording
- AUX (External input) : Only analog recording

"Adjusting the AUX input level" → 68

01 0:00
CD

The character information display shows the recording input source.

- If a CD or tape has already been loaded, it starts to play now. Press the ■STOP key to stop it.
- If the CD input is selected, the digital input is recorded automatically.



3. Start recording.

- ❶ Press the MD rec key (the unit enters record-pause mode).
- ❷ When the preparation is complete, press the MD rec key again.
- ❸ Play the music source to be recorded.

- When recording a CD, if **CD▶/II** key is pressed after step ❶, the MD starts recording at the same time as the CD starts to be played. → 41

Pause the recording

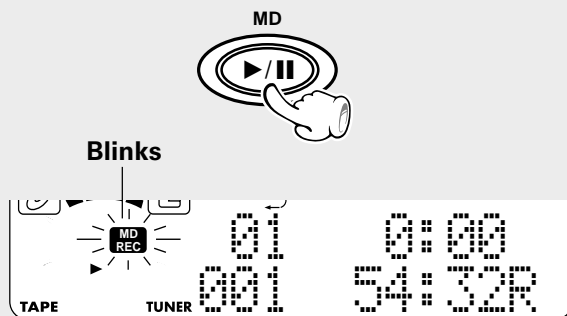

The recordable time for the MD is displayed.

- Press the key again to resume recording. At this time, the track number is incremented by "1".
- Recording can also be started by pressing the **MD rec** key.

Stop the recording

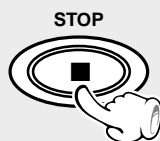

- Do not turn power off or apply shock or impact while "WRITING" is displayed. If the power cord is unplugged before "WRITING" disappears, the recorded or edited data will be lost.

In regard to track numbers at the time of recording

When a part without sound continues for 2 sec. or more during recording, the track number is automatically increased by "1" when the next sound enters. When classic music continues with low sound, the track number may be increased by "1". (The track number is not increased during recording of the tape or tuner input.)

The erroneously set track number can be erased later. When it is desired to increase the track No. during recording, press the TRACK EDIT key during recording to record a track No. at that position.

The track numbers are used at the time of playback to find the start of tracks, for programming, etc.

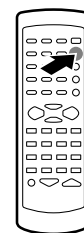

Press during recording.

TRACK EDIT



- With digital recording from a CD, the track number is increased when the track changes.



At the time of recording from a CD, the track number may be incremented when CD playback starts. This occurs because of a signal included in the digital signal from the CD. Delete unwanted track numbers under reference to "TRACK ERASE or ALL ERASE". → 50

In regard to display messages

Recording is not possible when one of the following messages is displayed.

- | | | |
|--------------------------------------------------|-----------------------------|------|
| "DISC FULL" : The minidisc is full. | → Erase unrequired tracks. | → 50 |
| "PROTECTED" : The write protect tab is open. | → Close it. | → 65 |
| "PLAY ONLY" : The minidisc is only for playback. | → Insert a recordable disc. | |

Stop the recording

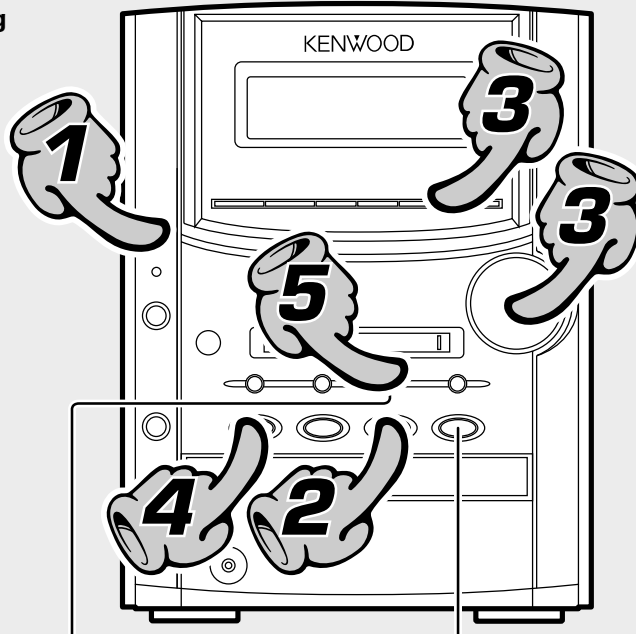
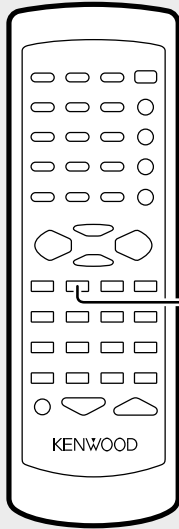

Pause the recording

Stop the recording

1. Load a tape in deck.

- ❶ Press the TAPE▲ key
- ❷ Insert a tape.
- ❸ Press the TAPE▲ key

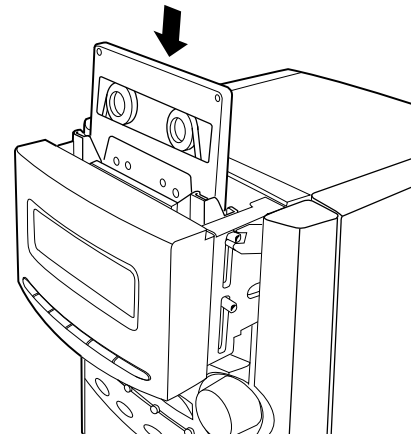

- Differentiation between normal (TYPE I) and high (TYPE II) tape is set automatically.
- Remove tape slack before loading.

2. Select the tape transport direction.

To reverse the transport direction

- ❶ Press the play key.
- ❷ Press the play key again.
- ❸ Stop playback.

- When recording is started, the tape is transported in the direction selected in this step.

Check the tape transport direction indicator.

- Wind the tape to the position where recording is to be started.

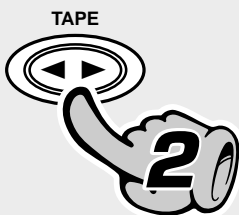

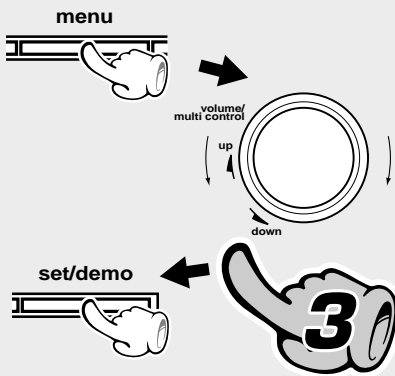

3. Set the recording condition.

Select the reverse mode. - 23

- The tape equalizer is defeated during recording.

Select an input source other than "TAPE"

Example:
To select the CD input

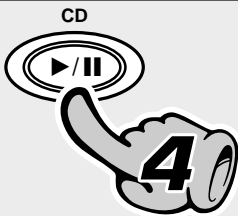

4. Select the source to be recorded.

CD
MD
TUNER (Broadcasts)
AUX (External input)

"Adjusting the AUX input level" - 58



The character information display shows the recording input source.

- If a CD or MD has already been loaded, it starts to play now. Press the ■STOP key to stop it.



5. Start recording.

- 1 Press the TAPE rec key.
- 2 Play (or tune) the input source to be recorded.

- Recording stops automatically when the tape side (s) to be recorded have been fully recorded.

Pause the recording



Blinks



- Press the **TAPE rec** key during recording. It stops after leaving a non-recorded blank of 4 seconds. (Press the key again to resume recording.)

Stop the recording

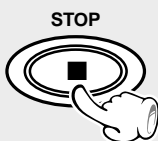

Note Note that this cassette deck cannot record onto Metal tapes.

Points in CD recording

When recording CD tracks onto a tape, if you leave the cassette deck in record-pause mode beforehand, the cassette deck recording can be started at the CD starts to be played.

- 1 Put the CD player in pause mode.
- 2 Select the track to be recorded with the skip (I-◀, ▶I) keys.
(The CD player pauses at the beginning of the selected track.)
- 3 Put the cassette deck in Record-pause mode.
(Press TAPE rec key twice)
- 4 Start playing the CD.
(Recording starts)

- To stop recording, press the ■STOP key.
- Recording from an MD is possible with the same procedure as above.

Do not use a cassette with more than 90-minute recording time, for the tape used with such a cassette is very thin and tends to cause troubles such as entanglement around the pinch roller or cutting of tape.

Listening in the desired sequence (program playback)

Use the following procedure to program desired tracks in a desired order. (up to 32 tracks)

Select the CD or MD input.

1 Let the "PGM" indicator light.

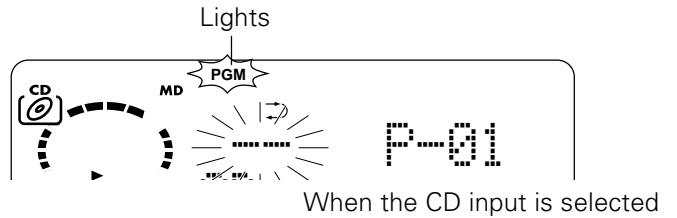
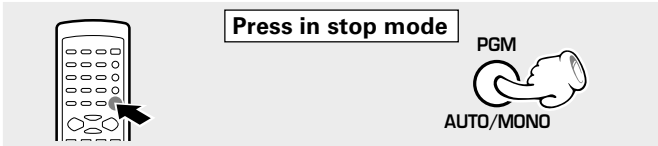

2 Select track numbers in the order you want to play them.

1 Select the track.

1	2 ABC	3 DEF
4 GHI	5 JKL	6 MNO
7 PRS	8 TUV	9 WXY
+100 &() -	0 QZ	+10' ;

2 Confirm the selection.

(To select more than one track, repeat steps 1 and 2 for each track.)

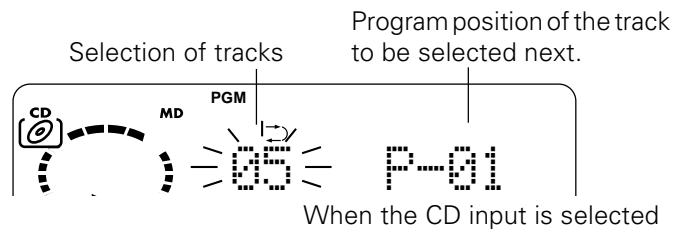

Press the numeric keys as shown below....

- To select track No. 23 : **+10 +10 3**
- To select track No. 40 : **+10 +10 +10 +10 0**
- To select track No. 213 : **+100 +100 +10 3**

- The **+100** key is used only with MD.
- A track can also be selected using the **◀◀/▶▶** key.
- Up to 32 tracks can be programmed. When "**PROGRAM FULL**" is displayed, no more tracks can be programmed.
- If you made a mistake, press the **CLEAR/DELETE** key and enter the track No. again.
- When a track No. is entered, the track will be added to the end of the existing program.
- "**-- :--**" is displayed when the total programmed period has attained 100 minutes or more.

3 Start playback.

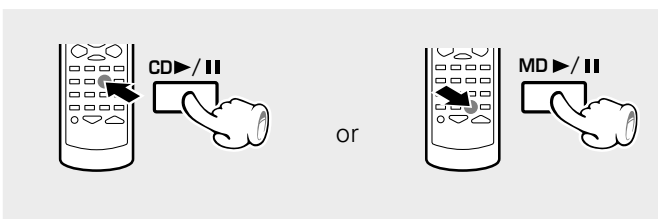

- Tracks will be played in the order they were programmed (following the program numbers).
- When the **◀◀/▶▶** key is pressed during play, the program will jump to the preceding or the following track respectively.
- When the **◀◀** key is pressed once during playback, the play position returns to the beginning of the current track being played.

To stop playback

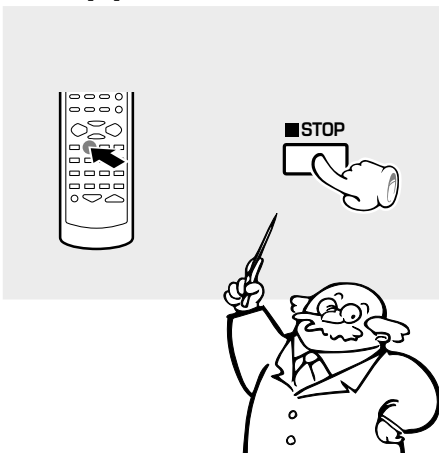

To quit the program mode

Clearing tracks from the end

Press in stop mode

CLEAR/DELETE

P-05
CLEAR

(P-5 has been deleted.)

- Each time the key is pressed, the last track in the program is cleared.

Clearing the program

Press in stop mode

PGM

AUTO/MONO

- The entire program is cleared.

Repeated playback

You can repeatedly listen to a favorite track or disc.

Select the CD or MD input.

Setup for repeating a single track

1 Confirm that the "PGM" indicator is not lit.

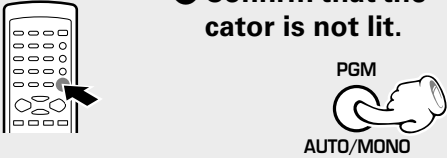

2 Play the track to be repeated.

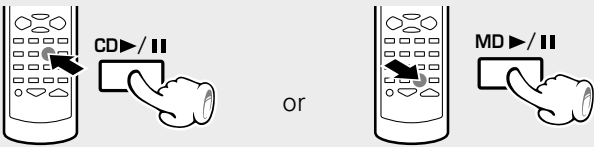

3 Select "REPEAT".

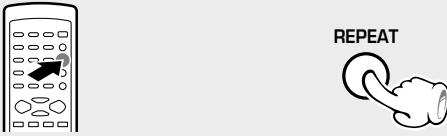

- If the "PGM" indicator is lit, press the **PGM/AUTO/MONO** key to turn it off. Confirm that this is not lit.

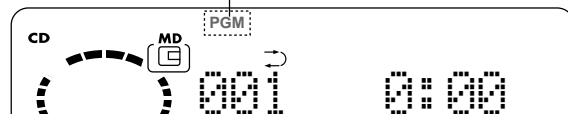

When the MD input is selected

Each press switches the repeat mode.

- ① REPEAT
- ② REPEAT ALL
- ③ Off.... Repeat deactivated

- For instance, to repeat track No. 3, select **REPEAT** in the middle of its playback or during pause on it.

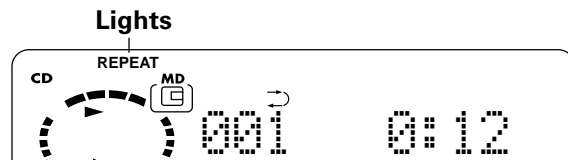

When the MD input is selected

Setup for repeating all tracks in a disc

1 Confirm that the "PGM" indicator is not lit.

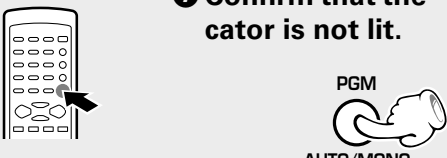

2 Select "REPEAT ALL".



3 Start playback

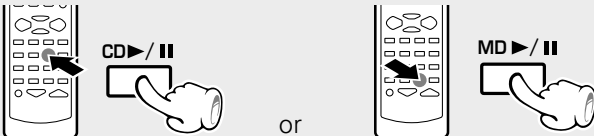

- If the "PGM" indicator is lit, press the **PGM/AUTO/MONO** key to turn it off. Confirm that this is not lit.

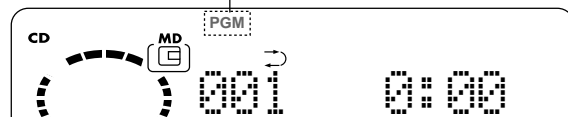

When the MD input is selected

Each press switches the repeat mode.

- ① REPEAT
- ② REPEAT ALL
- ③ Off.... Repeat deactivated

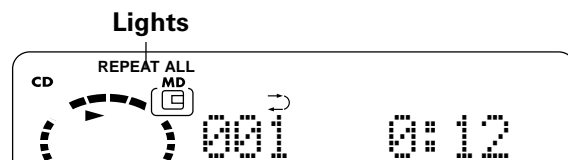

When the MD input is selected

Setup for repeating selected tracks

- Program the track sequence according to steps 1 to 2 of "Listening in the desired sequence". → 32

- Select "REPEAT ALL".

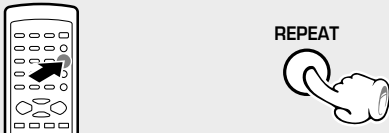

- Start playback

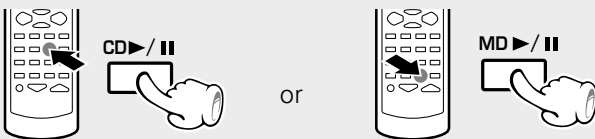

Each press switches the repeat mode.

- REPEAT ALL
- Off... Repeat deactivated

- All selected tracks will be repeated.

"REPEAT ALL", "PGM" light.

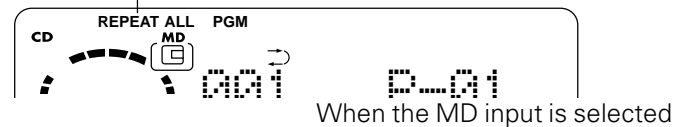

To stop repeated playback

Press the REPEAT key repeatedly until the repeat mode is switched off.

- The "REPEAT ALL" indicator turns off and playback according to the current CD player or MD recorder mode.

Listening to an unexpected title sequence (random playback)

As the titles each time are selected randomly, the music can be enjoyed without getting tired of it.

Select the CD or MD input.

- Confirm that the "PGM" indicator is not lit.



- If the "PGM" indicator is lit, press the PGM/AUTO/MONO key to turn it off.

Confirm that this is not lit.

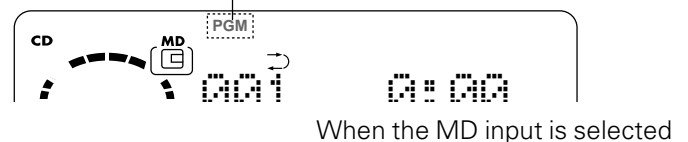

- Press the RANDOM key.

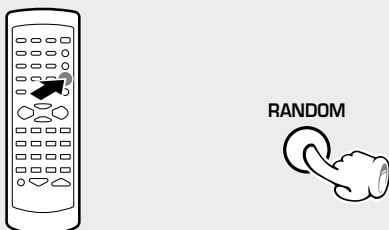

Each press switches the modes as follows.

- "RANDOM" on ... Random playback
- "RANDOM" off ... Normal playback

Lights

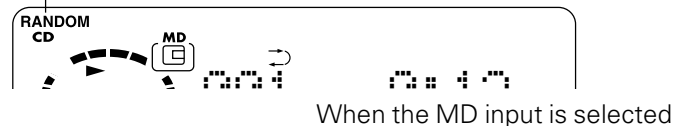

- Playback stops after each title has been played once.
- The random playback can also be repeated by pressing the REPEAT key.

To select another track in the middle of playing one

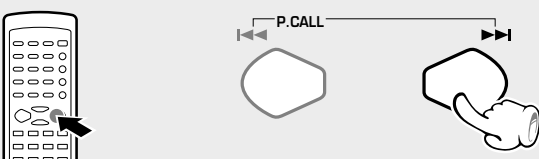

- Pressing the P.CALL key returns the playback position to the beginning of the track being played.

To cancel random playback



- The "RANDOM" indicator goes off and the playback in order of the tracks starts from the track being played.

RDS is a system which transmits useful information (digital data) for FM broadcasts together with the broadcast signal. Tuners and receivers designed for RDS reception can extract the information from the broadcast signal for use with various functions such as automatic display of the station name.

This unit is equipped with the following functions utilizing RDS data :

PTY (Program Type Identification) Search : → 36

The tuner automatically searches for a station which is currently broadcasting a specified program type (genre).

PS (Program Service Name) Display :

When an RDS broadcast is received, the station name is automatically displayed.

The “RDS” indicator lights up when an RDS broadcast (signal) is received.

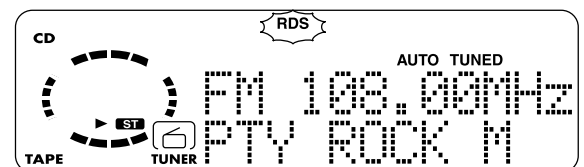

- Some functions may not be provided or be given different names depending on countries or areas.

Before using RDS

For reception of RDS stations, the auto presetting function must be used to preset the stations. With the auto presetting function, RDS stations are preset with priority. “NO DATA” will be flashed when a station is not preset by auto presetting.

Searching for a desired program type (PTY search)

By specifying the type of program (genre) you want to listen to, the tuner automatically searches for a station which is currently broadcasting a program of the specified type.

Set the reception band to FM. Preset RDS stations with the auto preset function.

1 Select the PTY search mode.

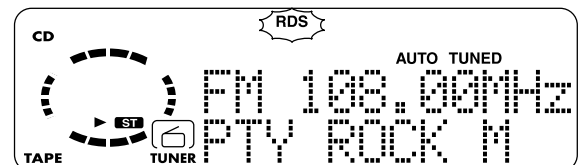
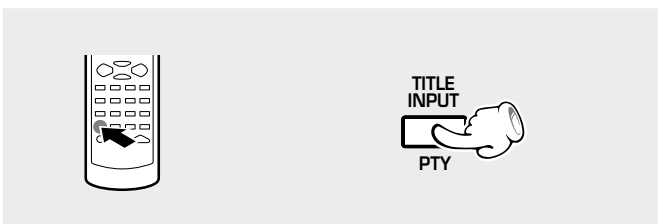

When an RDS broadcast is received, the program type is shown on the display. If no PTY data is available, or if the station is not an RDS station, "NONE" is displayed.

2 Select the desired program type.

Use program type table on the right for your convenience.

Program type table

A Selection with the \leftarrow or \rightarrow key

Select while "PTY" is lit.

The desired program type can be selected with the \leftarrow or \rightarrow key from 29 types. Press the key and release it when the desired type is displayed.

B Selection with the numeric keys

1	2 ABC	3 DEF
4 GHI	5 JKL	6 MNO
7 PRS	8 TUV	9 WXY
0	QZ	+10:.

The program types 1 to 9 and 0 can be selected directly with the number keys. Use the \leftarrow or \rightarrow key to select other program types.

(A) \leftarrow/\rightarrow keys	(B) Program Type Name	Display	
DOWN ↑ ↓ UP \rightarrow	1 Pop Music	POP M	
	2 Rock Music	ROCK M	
	3 Easy listening music	EASY M	
	4 Light Classical	LIGHT M	
	5 Serious Classical	CLASSICS	
	6 Other Music	OTHER M	
	7 News	NEWS	
	8 Current Affairs	AFFAIRS	
	9 Information	INFO	
	0 Sport	SPORT	
		Education	EDUCATE
		Drama	DRAMA
		Culture	CULTURE
		Science	SCIENCE
		Varied	VARIED
		Weather	WEATHER
		Finance	FINANCE
		Children's programs	CHILDREN
		Social affairs	SOCIAL A
		Religion	RELIGION
		Phone in	PHONE IN
		Travel	TRAVEL
		Leisure	LEISURE
		Jazz music	JAZZ
		Country music	COUNTRY
		National music	NATION M
		Oldies music	OLDIES
		Folk music	FOLK M
		Documentary	DOCUMENT

3 Start the search.

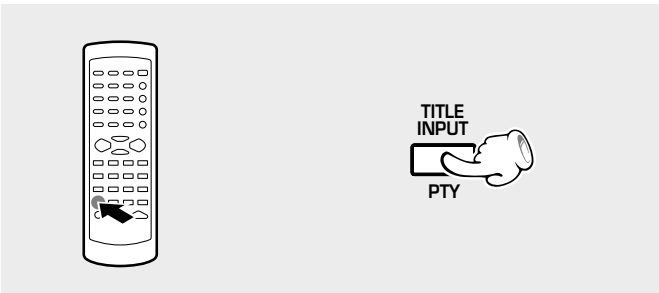

- No sound is heard while "PTY" is blinking.
- If a program of the desired type cannot be found, "NO PROG" is displayed, then after several seconds the display returns to the original display.
- If a program of the desired type is found, that program is received and the program type name display changes temporarily to the station name display.

To change to a different program type :

Repeat steps **1**, **2**, **3**.

When searching for a Rock Music broadcast

Display while the tuner is searching.

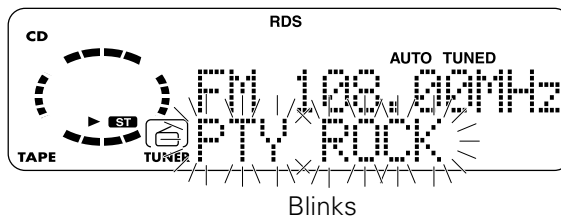

Blinks

Program type name display.

When a station is received.

Goes off

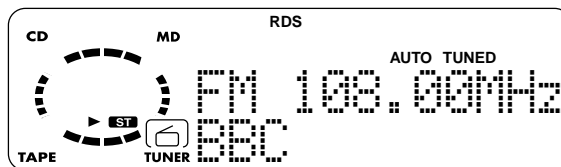

Station name display.

Selection of the recording type

This unit provides the following recording features in addition to normal recording. Select the appropriate method according to the purpose of recording.

Recording a CD onto an MD in short time

CD→MD high-speed (2x-speed) dubbing

→ 40

All-track high-speed recording

Records a CD onto an MD in a short period. All tracks in a CD can be recorded onto an MD in half the normal playback period.

To record CD with a simplified method

One-touch edit recording (CD→MD/ CD→TAPE)

→ 41

All-track recording

Records all tracks in a CD onto either an MD or tape.

Single-track recording

Records only one CD track being played onto either an MD or tape. (This is convenient for recording of desired tracks from a disc being heard for the first time.)

- One-touch edit recording from an MD to Tape is not available.

To record CD simultaneously onto an MD and tape

TWIN REC (CD→MD, TAPE)

→ 42

All-track twin recording

Simultaneous recording of an entire CD onto an MD and tape.

single-track twin recording

Simultaneous recording of the CD track being played onto an MD and tape. (This is convenient for recording of desired tracks from a disc being heard for the first time.)

To record desired CD or MD tracks by reordering them

Program recording (CD→MD/ CD→TAPE/ TWIN REC/ MD→TAPE)

→ 43 → 44

Program recording

Recording of programmed tracks in the programmed order. (Convenient for recording only the desired CD or MD tracks in the desired order.) Simultaneous recording of programmed CD tracks onto both MD and Tape is also possible.



With recording onto tape, the track will be interrupted for the part of the guide tape at the tape reversal, where recording is not possible. Please use single-side recording if this is to be avoided.

All-track high-speed recording (CD → MD)

Records a CD onto an MD in a short period.

Be sure to put the MD recorder and cassette deck in stop mode.

1 Make the preparations for recording.

- ① Select the CD input.
- ② Ensure that "PGM", "REPEAT" and "REPEAT ALL" are not lit.
- ③ MD : Insert a disc into the MD recorder.
- ④ Insert disc in the CD player.

- If the "PGM" indicator is lit, press the **PGM/AUTO/MONO** key to turn it off.
- Press the **REPEAT** key repeatedly until the repeat mode is switched off.

2 Start recording.

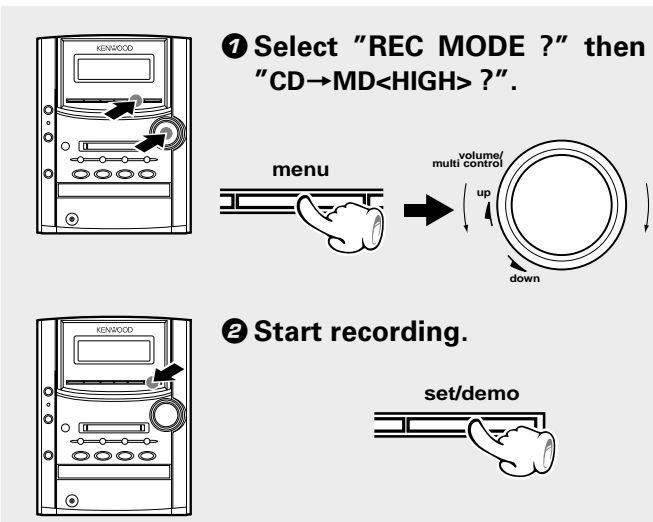

Turning the knob switches the function as shown in the character information display.

- ① CD→MD<NORM> ?
- ② CD→MD<HIGH> ?
- ③ CD→TAPE ?
- ④ TWIN REC ?

- High-speed recording starts with the first track in the CD and continues until the last track.
- During high-speed recording, the CD playback audio is played at a high speed and low volume.
- When either high-speed CD playback or MD high-speed recording stops, the other operation also stops.

To interrupt a recording



- One high-speed recording starts, it is not permitted to record the same disc with high-speed recording for 74 minutes after the start of recording. If you want to record the same disc immediately, use one-touch edit recording (recording at normal speed). → 41

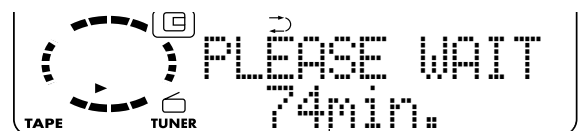

Time period until high-speed recording of the same disc is permitted

Do not turn power off or apply shock or impact while "WRITING" is displayed. If the power cord is unplugged before "WRITING" disappears, the recorded or edited data will be lost.

The recorded audio may skip, noise may be recorded on the MD or unnecessary tracks may be created depending on the condition of the CD. In such a case, restart recording at the normal speed.

One-touch edit recording (CD → MD / CD → TAPE)

Records all tracks in a CD with a simple operation. (All-track recording)

Records a single CD track being played from the beginning. (Single-track recording)

Be sure to put the MD recorder and cassette deck in stop mode

1 Make the preparations for recording.

CD → MD

- 1 Insert a disc into the MD recorder.
- 2 Insert disc in the CD player.

CD → TAPE

- 1 Perform steps 1 to 3 of the procedure in "Recording on TAPE". → 30
- 2 Insert disc in the CD player.

2 Check the current play mode of the CD player.

All-track recording

If it is in play mode, stop it.

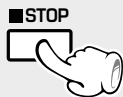

Single-track recording

Select the desired CD track and play it. → 17

To record other tracks, repeat steps 2 and 3 for each track.

3 Start recording.

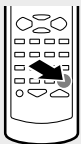

- When the **MD O.T.E.** or **TAPE O.T.E.** key is pressed for "Single-track recording", the CD track being played is replayed from the beginning and recording start at the same time.
- The recording operation can also be controlled from the main unit, by setting "REC MODE" to "CD → MD<NORM>" or "CD → TAPE".

To interrupt a recording

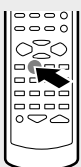

(Recording and playback will be stopped.)

At the end of the recording

MD recorder : Stop.

Cassette deck : Stop is executed after an unrecorded portion of about 4 sec. has been produced.

Do not turn power off or apply shock or impact while "WRITING" is displayed. If the power cord is unplugged before "WRITING" disappears, the recorded or edited data will be lost.



Note that this cassette deck cannot record onto Metal tapes.

Twin recording onto MD and tape (TWIN REC) (Main unit only)

All the tracks on a CD can be recorded simultaneously onto an MD and tape. (All-track twin recording)
The current track can be recorded from the beginning simultaneously onto an MD and tape. (single-track twin recording)

Be sure to put the MD recorder and cassette deck in stop mode.

1 Make the preparations for recording.

- ① MD : Insert a disc into the MD recorder.
TAPE : Perform steps 1 to 3 of the procedure in "Recording on TAPE".
- ② Insert disc in the CD player.

→ 30

2 Check the current play mode of the CD player.

All-track twin recording

If it is in play mode, stop it.

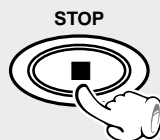

Single-track twin recording

Select the desired CD track and play it. → 17

To record other tracks using "Single-track twin recording", repeat steps 2 and 3 for each track.

3 Start recording.

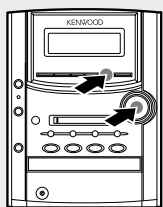

- ① Select "REC MODE ?" then "TWIN REC ?".

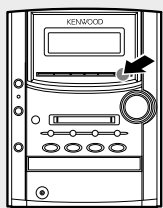
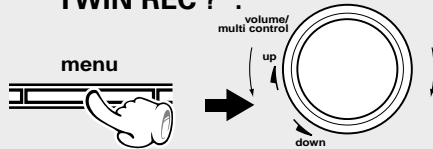

- ② Start recording.

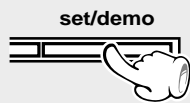

Turning the knob switches the display contents.

- ① CD→MD<NORM> ?
- ② CD→MD<HIGH> ?
- ③ CD→TAPE ?
- ④ **TWIN REC ?**

- With single-track simultaneous recording, when the **set/demo** key is pressed, the "MD REC" and "TAPE REC" indicators light and recording starts by returning to the beginning of the current track.

To interrupt a recording

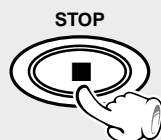
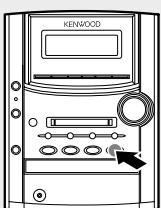

(Recording and playback will be stopped.)

At the end of the recording

MD recorder : Stop.
Cassette deck : Stop is executed after an unrecorded portion of about 4 sec. has been produced.

Do not turn power off or apply shock or impact while "WRITING" is displayed. If the power cord is unplugged before "WRITING" disappears, the recorded or edited data will be lost.



Note that this cassette deck cannot record onto Metal tapes.

Program recording (CD → MD / CD → TAPE / TWIN REC)

Desired CD tracks can be programmed in the desired sequence and recorded onto an MD or tape.

Be sure to put the MD recorder and cassette deck in stop mode.

1 Make the preparations for recording.

- ① MD : Insert a disc into the MD recorder.
TAPE : Perform steps 1 to 3 of the procedure in "Recording on TAPE". → 30
- ② Insert disc in the CD player.

2 Program the desired sequence of CD tracks.

Perform steps ① and ② of the procedure in "Listening in the desired sequence (Program playback)". → 32

3 Start recording.

- When the PGM/AUTO/MONO key is pressed to cancel the edited contents, the entire editing contents will be erased. → 32
- Tracks programmed beyond the available MD or tape recording time will be interrupted in the middle.

CD → MD / CD → TAPE

The diagram shows two remote control units. The top one has a button labeled 'MD O.T.E.' with an arrow pointing to it. The bottom one has a button labeled 'TAPE O.T.E.' with an arrow pointing to it. The word 'or' is centered between the two units.

TWIN REC

The diagram shows two steps: 1. Selecting 'REC MODE ?' then 'TWIN REC ?' by pressing the 'menu' button and then the 'volume/multi control' knob (turning it up or down). 2. Starting recording by pressing the 'set/demo' button.

To interrupt a recording

The diagram shows a remote control with an arrow pointing to the 'STOP' button. Below it, the text reads: "(Recording and playback will be stopped.)"

At the end of the recording
 MD recorder : Stop.
 Cassette deck : Stop is executed after an unrecorded portion of about 4 sec. has been produced.

Do not turn power off or apply shock or impact while "WRITING" is displayed. If the power cord is unplugged before "WRITING" disappears, the recorded or edited data will be lost.

Note Note that this cassette deck cannot record onto Metal tapes.

Program recording (MD → TAPE)

Desired MD tracks can be programmed in the desired sequence and recorded onto a tape.

Be sure to put the MD recorder and cassette deck in stop mode.

1 Make the preparations for recording.

- MD : Insert a disc into the MD recorder.
 TAPE : Perform steps 1 to 3 of the procedure in "Recording on TAPE". → 30

2 Program the desired sequence of MD tracks.

Perform steps 1 and 2 of the procedure in "Listening in the desired sequence (Program playback)". → 32

3 Put the MD recorder in pause mode before starting program playback.

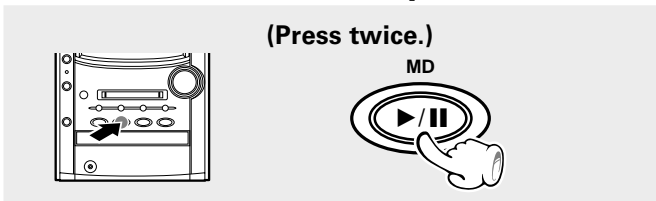

- When the **PGM/AUTO/MONO** key is pressed to cancel the edited contents, the entire editing contents will be erased.
- Tracks programmed in excess of the tape recording time will be cut off.

4 Put the tape deck in record-pause mode.



- When program playback starts, press the **◀◀** key once to return to the beginning of the track.

5 Start recording.



- Tape recording starts at the same time as the MD program playback.

To interrupt a recording

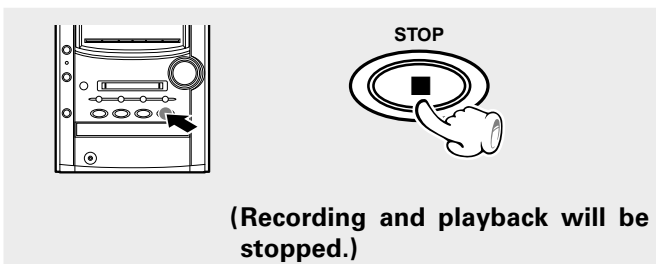

At the end of the recording

Cassette deck : Stop is executed after an unrecorded portion of about 4 sec. has been produced.



Note that this cassette deck cannot record onto Metal tapes.

Selecting the editing function type

When a commercially available Mini Disc fabricated for user recording is used, various editing operations can be applied after recording. Note that editing is not possible with commercially available prerecorded Mini Disc software designed for playback only.

Function Limitations because of the MD Standard

Some of the functions are limited because of the MD standard. Please check this before assuming a malfunction. → 66

For editing, set the write protect tab of the mini disc to "Write enable" side. → 65

Reordering tracks by moving them

Moving a single track (TRACK MOVE) → 46

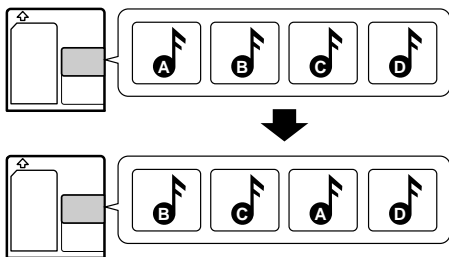

Dividing a track, combining two tracks

TRACK DIVIDE → 48

TRACK COMBINE → 49

Dividing a track into two

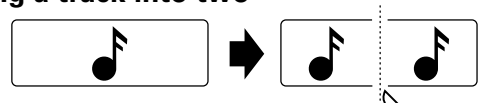

Combining two tracks into one



Erasing track(s)

Erasing a single track (TRACK ERASE) → 50

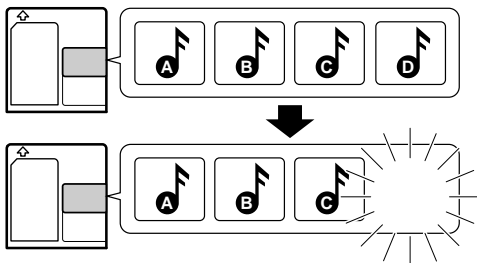

Erasing all tracks on a disc (ALL ERASE) → 50

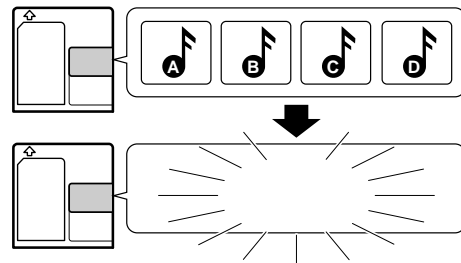

Assigning a Title to a Disc or a Track → 51

Changing or deleting a title → 54

Copying a Disc or Track Title in a Title Memo (TITLE COPY) → 55

Copying title memo contents as the title of another disc or track → 56

Title input is possible simply by selecting one character after another from the characters shown on the display. As the entered title is compatible between models, it will be displayed also when the disc is set into a different MD recorder (player). (The title compatibility is limited partly according to the character types which can be displayed, the number of characters, etc.)

In regard to display scrolling

A MD title or track title may consist of too many characters to be shown in a single display page. In such a case, the characters on the display scroll from the right to the left and the rest of the information can be seen. This is called "scrolling".

Scrolling image

Displayed area (All cannot be displayed.)

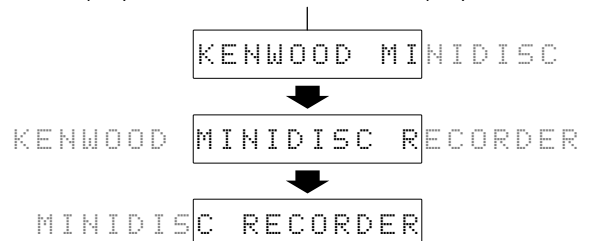

Moving a single track (TRACK MOVE)

This procedure shows you how to select and move (insert) a track to the track number you desire. The surrounding tracks are renumbered automatically.

Repeating this procedure lets you arrange the tracks in the order you desire.

Always eject the MD after title entry or editing.

Please execute operation in stopped condition.

1 Select "MOVE".

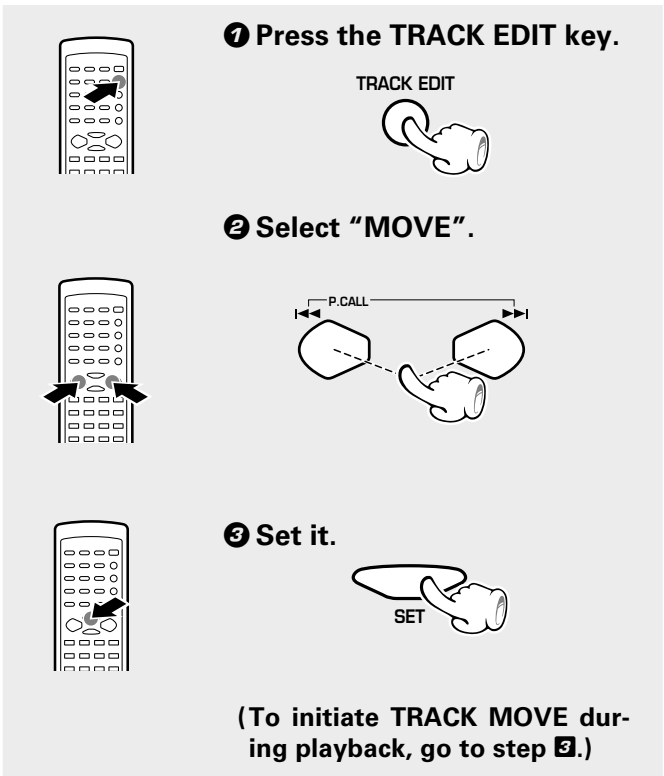

1 Press the TRACK EDIT key.
 TRACK EDIT

2 Select "MOVE".
 P.CALL

3 Set it.
 SET

(To initiate TRACK MOVE during playback, go to step 2.)

To abort "MOVE" in the middle, press the TRACK EDIT key.

Each press switches the operation.

When pressed in stop mode

When pressed in play mode

- ① MOVE
- ② COMBINE
- ③ ERASE

- ① DIVIDE
- ② COMBINE
- ③ ERASE
- ④ MOVE

"COMBINE" is not displayed during playback or pause of the first track.

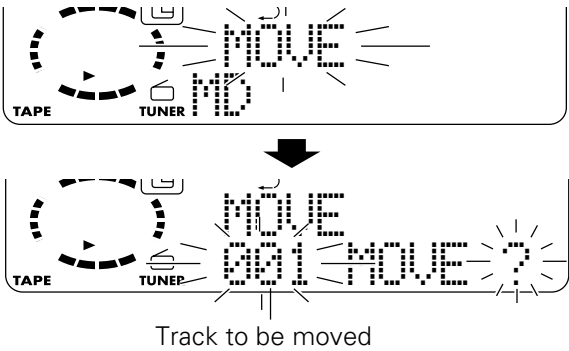

2 Select the track to be moved.

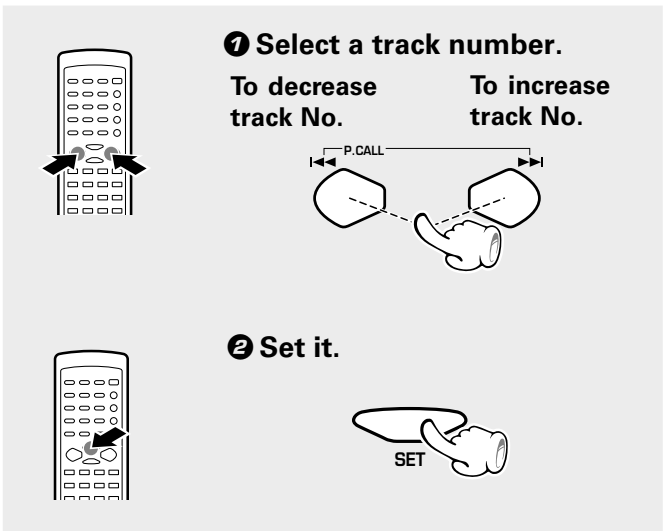

1 Select a track number.
 To decrease track No. To increase track No.
 P.CALL

2 Set it.
 SET

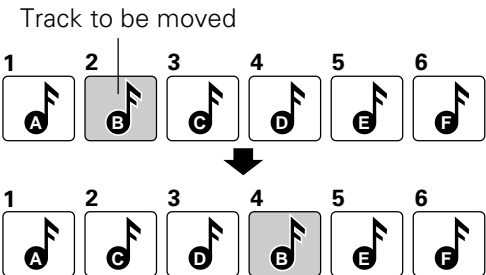
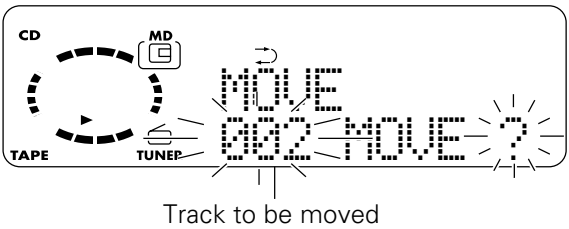

3 Select the moving destination track.

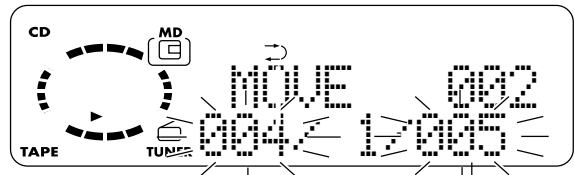
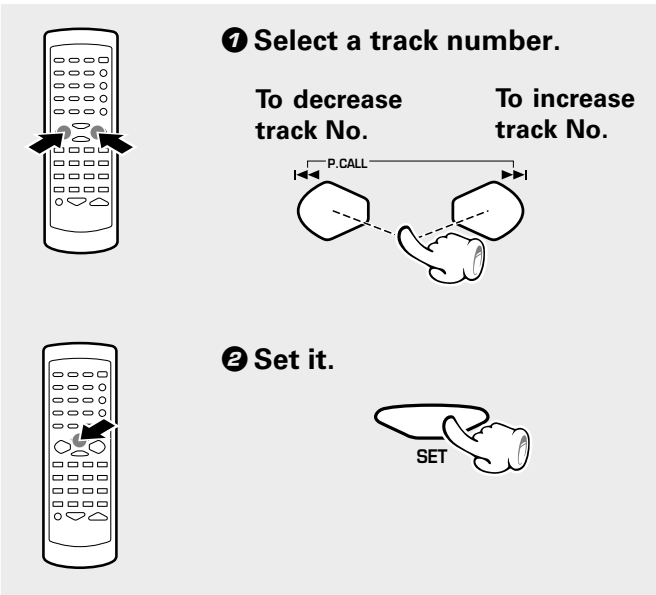

Destination track No.

4 Execute track move.

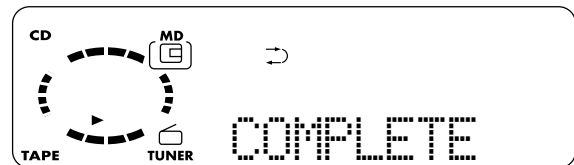
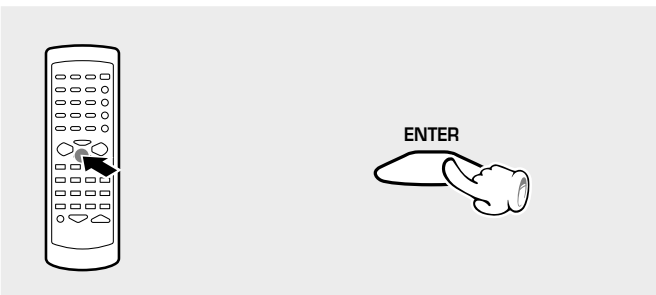

5 After editing, eject and remove the mini disc.

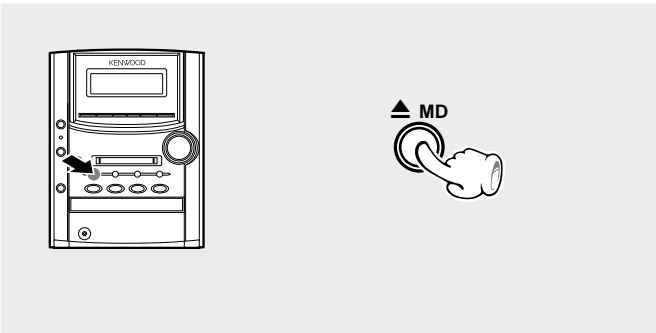

Do not turn power off or apply shock or impact while "WRITING" is displayed. If the power cord is unplugged before "WRITING" disappears, the recorded or edited data will be lost.

Dividing a track (TRACK DIVIDE)

Use the following procedure to divide a track into two by inserting a track number in its middle. For example, by inserting an additional track number before the passage you are specially fond of, it is easy to skip to there when you play the disc later. Note that the track numbers of the tracks located after the divided track are automatically incremented.

Always eject the MD after title entry or editing.

Do not turn power off or apply shock or impact while "WRITING" is displayed. If the power cord is unplugged before "WRITING" disappears, the recorded or edited data will be lost.

Perform the operations in the following procedure while the display is blinking.

1 Play the track to be divided.

2 Press the TRACK EDIT key at the desired position.

• This operation is also possible during pause.

1 Press the TRACK EDIT key.

TRACK EDIT

(Pressing the key during playback initiates pause.)

2 Select "DIVIDE".

P.CALL

3 Set it.

SET

• To abort "DIVIDE" in the middle, press the TRACK EDIT key.

Each press switches the operation.

- ① DIVIDE
- ② COMBINE
- ③ ERASE
- ④ MOVE

• "COMBINE" is not displayed during playback or pause of the first track.

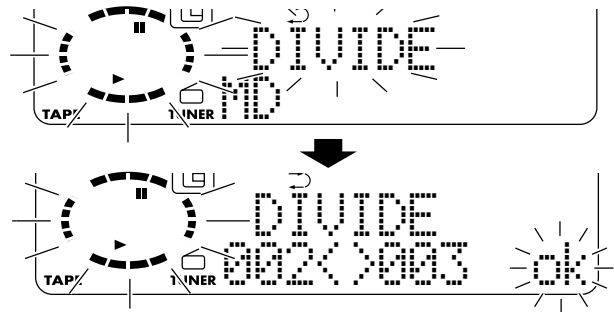

3 Execute the track divide operation.

ENTER

(Up to 254 track numbers can be inserted additionally by repeating 1 to 3 for each of them.)



• There is no blank space left between the two tracks.
 • When the track to be split has a title, the two tracks will have the same title.

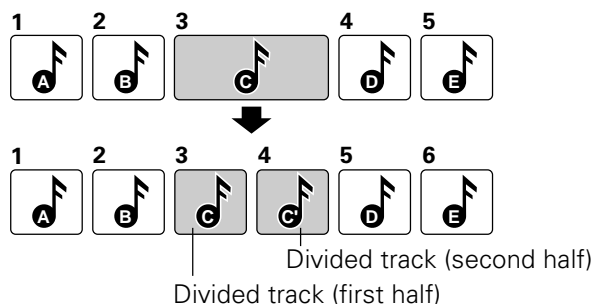

4 After editing, eject and remove the mini disc.

Combining two tracks (TRACK COMBINE)

Combines two adjacent tracks into a single track. After this operation, the track numbers of tracks located after the combined tracks are decreased automatically.

Always eject the MD after title entry or editing.

Do not turn power off or apply shock or impact while "WRITING" is displayed. If the power cord is unplugged before "WRITING" disappears, the recorded or edited data will be lost.

Perform the operations in the following procedure while the display is blinking.

1 Select "COMBINE".

1 Press the **TRACK EDIT** key.

2 Select "COMBINE".

3 Set it.

(If you combine tracks during playback, go to step 3.)



"COMBINE" cannot be selected if the track being played is the first track on the disc.

- To abort "COMBINE" in the middle, press the **TRACK EDIT** key.

Each press switches the operation.

When pressed in stop mode

- 1 MOVE
- 2 **COMBINE**
- 3 ERASE

When pressed in play mode

- 1 DIVIDE
- 2 **COMBINE**
- 3 ERASE
- 4 MOVE

When pressed in stop mode

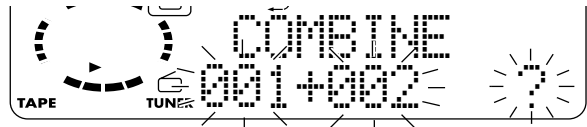

- To combine two tracks during playback, press the **TRACK EDIT** key while the second track is being played.

2 Select the track to be combined.

1 Select the track number.

To decrease track No. To increase track No.

2 Set it.

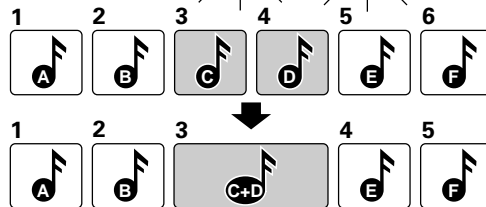
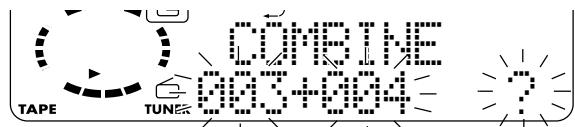

Track No. and title of the first track are left. (Track No. and title of the second track are cleared.)

3 Execute the track combine operation.

ENTER

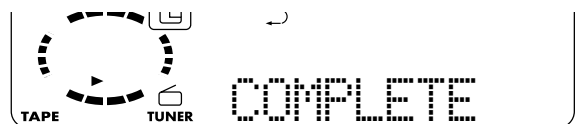

4 After editing, eject and remove the mini disc.

Erasing a single track (TRACK ERASE) or erasing all tracks on a disc (ALL ERASE)

TRACK ERASE

During playback, it is possible to erase only the track being played. The track numbers of the tracks after the erased track will be adjusted. Be careful in using this operation because a track cannot be recovered once it has been erased.

Perform the operations in the following procedure while the display is blinking.

Erasing a single track

1 Play the track to be erased.

2 Select "ERASE".

1 Select "ERASE".

TRACK EDIT

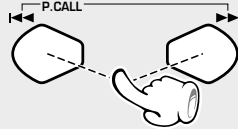

- To abort "TRACK ERASE" in the middle, press the **TRACK EDIT** key.
- "COMBINE" is not displayed during playback or pause of the first track.

2 Set it.

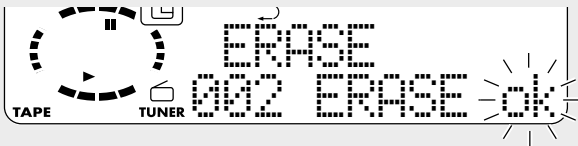

3 Execute the erase operation.

ENTER



4 After editing, eject and remove the mini disc.

- To delete a track while in stop mode, use the procedure for "Erasing all tracks on a disc" and select the track to be deleted using the **◀◀** or **▶▶** key in step **2-2**.

Always eject the MD after title entry or editing.

Do not turn power off or apply shock or impact while "WRITING" is displayed. If the power cord is unplugged before "WRITING" disappears, the recorded or edited data will be lost.

ALL ERASE

During stop, all tracks can be erased. Be careful in using this operation because the tracks cannot be recovered once the entire minidisc has been erased.

Erasing all tracks on a disc

1 Stop the disc.

2 Select "ALL ERASE".

1 Select "ERASE".

TRACK EDIT

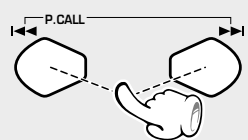

- To abort "ALL ERASE" in the middle, press the **TRACK EDIT** key.

2 Set it.



"ALL ERASE ?" is displayed.

- A track can also be erased by selecting the track number with the **◀◀** or **▶▶** key.

3 Set it.

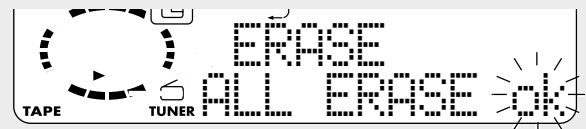

3 Execute the erase operation.

ENTER



4 After editing, eject and remove the mini disc.

Assigning a title to a disc or track

When titles are assigned to a disc and its tracks, the titles cannot only be displayed during playback but title search (searching a track by the title) is also made possible. The assigned titles can be changed or deleted with the same procedure.

Always eject the MD after title entry or editing.

Do not turn power off or apply shock or impact while "WRITING" is displayed. If the power cord is unplugged before "WRITING" disappears, the recorded or edited data will be lost.

Execute operation in stopped condition or during playback.

1 Activate the title input mode.

1 Press the TITLE INPUT key.



2 Select whether the disc title or track title input.

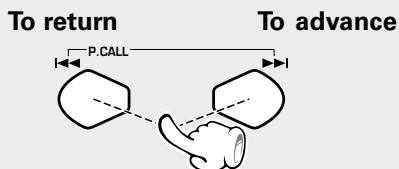

3 Set the selection.



(To abort operation, press the TITLE INPUT key again.)



Disc titles can be assigned in stop mode. When the MD▶/|| key pressed before step 1-3 while assigning a title to a track, the title can be entered while listening to that track.

- To cancel title editing in the middle, press the TITLE INPUT key.
- It takes a while because data should be read out of the disc.

In case of disc title

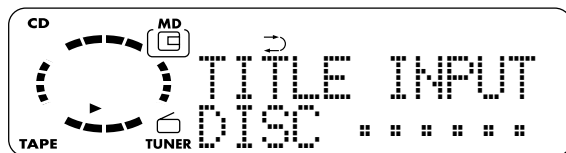

In case of track title

Select the desired track No.

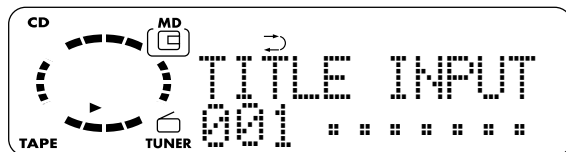

List of registered symbols (ASCII codes):

! " # \$ % & ' () * + , - . / : ; < = > ` ? @ _ ^

Total number of title characters

Up to 1792 characters can be input per disc and up to 80 characters can be input per track.

A space (blank character) also require the same amount of data as alphanumeric characters. To erase the title, do not enter a space but delete each character using the CLEAR/DELETE key. — 54

Continued on next page

2 Input the title.

Characters can be selected either in the "character input key mode" or "skip key mode".

To enter a character using the character input keys (Character input key mode):

If "Aa" or "12" is displayed, press any character input key.

- 1 Press the **DISPLAY/CHARAC.** key repeatedly to select a character group.



- 2 Select the first character by pressing a character input key.

- Pressing a key more than once changes the character input with it.
(Example: When the ABC key is pressed)
Each press changes the character which can be input.

A → B → C → a → b → c.

- Press the ◀ or ▶ key to move the input location (cursor) to the left or right.
- If you made a mistake, press the **CLEAR/DELETE** key to delete the incorrect character.

- 3 Press the **SET** key to set the character.



(Repeat steps 1 to 3 for each character to be entered.)

The character group which can be used in the "character input key mode" are as follows.

"Aa" group

A to z, symbols plug title memos ([1], [2], [3])

"12" group

0 to 9 and symbols.

In case of disc title

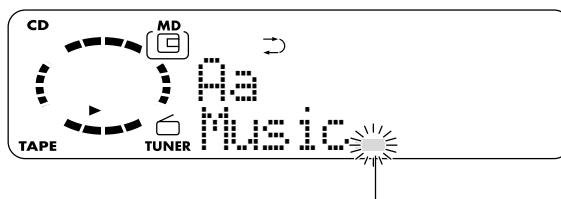

The cursor moves and waits for input of the next character.

Title editing character list

The following uppercase and lowercase alphabets and symbols can be used in title editing.

Key	Group	"Aa"	"12"
1		space [1] [2] [3]	1
2	ABC	ABCabc	2
3	DEF	DEFdef	3
4	GHI	GHIghi	4
5	JKL	JKLjkl	5
6	MNO	MNOmno	6
7	PRS	PRSprs	7
8	TUV	TUVtuv	8
9	WXY	WXYwxy	9
0	QZ	QZqz	0
+10	' , : :	' , : ? ! ; . " _ ` \$ space	
+100	& () -	& () - / + * = < > # % @	
TIME/SPACE		space	

- The first alphabet which appears when a character input key is pressed may sometimes be an uppercase or sometimes a lowercase letter depending on each occasion.

Selecting characters using the ◀◀or▶▶key (Skip key mode)

If "Aa" or "12" is displayed, press the ◀◀or ▶▶key.

- 1 Press the DISPLAY/CHARAC. key repeatedly to select a character group.



- 2 Press the ◀◀ or ▶▶ key to move the selection cursor on the desired character.

- Holding the ◀◀ or ▶▶ key scrolls the display so any character in the same character group can be selected.
- Press the ◀◀ or ▶▶ key to move the input location (cursor) to the left or right.

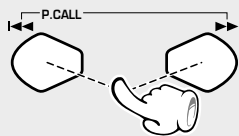

- 3 Press the SET key to enter the selected character.



(Repeat steps 1 to 3 for each character to be entered.)

The character group which can be used in the "skip key mode" are as follows.

Uppercase alphabet group

A to Z and space (1 blank character)

Lowercase alphabet group

a to z and space

Numeral and symbol group

0 to 9, space and symbols

Title group

Title memos ([123]), disc title and track titles

Example with an MD title

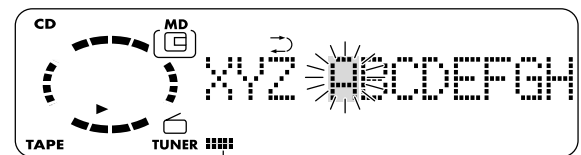

The cursor moves and waits for input of the next character.

Selecting characters using the ◀◀/▶▶keys (Skip key mode)

Uppercase alphabet group	ABCDEFGHIJKLMNOPQRSTUVWXYZ space
Lowercase alphabet group	abcdefghijklmnopqrstuvwxyz space
Numeral and symbol group	0123456789 space ! " # \$ % & ' () * + , - . / : ; < = > ` ? @ space _
Title group	[1 2 3] [DISC] [001] [002]

- In the "Skip key mode" for character entry, a title memo or the title of another disc/track can be copied and entered in the same way as the entry of alphabet characters.

3 Executing title input

1 Press the ENTER key to set the title input.

- If power is switched off (to STANDBY mode) or the **TITLE INPUT** key is pressed to cancel setting before the ENTER key is pressed here, the inputs made until then will be cleared.



2 Press the TITLE INPUT key to exit from editing.



3 Press the ▲ MD key and eject the MD.

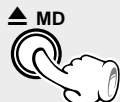

- When the **ENTER** key is pressed, the selection of the next title (disc title or track title) to be edited can be restarted. To continue editing of another title, repeat the above procedure from step **1-2**.

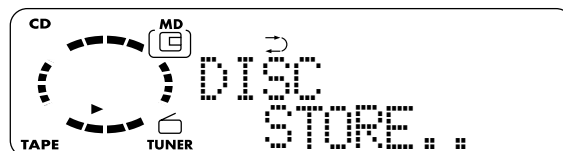

Do not turn power off or apply shock or impact while "WRITING" is displayed. If the power cord is unplugged before "WRITING" disappears, the recorded or edited data will be lost.

Changing or deleting a title

1 Perform step 1 in "Assigning a title to a disc or track" to select the disc title or track title to be changed or erased.

2 Press the ◀◀ or ▶▶ key to place the cursor on the character to be modified or erased.

- If it is required to insert a character, place the cursor on the character immediately before the desired insertion location.

3 Press the CLEAR/DELETE key to delete the character. (If you are erasing the title, go to step 5.)

4 If you are changing the title, perform step 2 in "Assigning a title to a disc or track".

5 Perform step 3 in "Assigning a title to a disc or track".

Erasing all titles

1 Select the MD input and press the TITLE INPUT key.

2 Press the ◀◀ or ▶▶ key repeatedly to select "ALL ERASE".

3 Press the SET key to set the "ALL ERASE" selection.

4 Press the ENTER key to erase all titles.

- All of the disc and track titles are erased.

5 Press the TITLE INPUT key to exit from editing.

6 Press the ▲ MD key and eject the MD.

Copying titles in title memos for use as titles of other MDs or tracks

To make character entry simpler, disc titles, track titles and/or performer names can be saved in title memos ([1] to [3]) and copied them with another disc or track. The title memos can save up to three sets of titles and/or input character sets.

Always eject the MD after title entry or editing.

Do not turn power off or apply shock or impact while "WRITING" is displayed. If the power cord is unplugged before "WRITING" disappears, the recorded or edited data will be lost.

Copying a disc or track title in a title memo (TITLE COPY)

- 1 Press the **TITLE INPUT** key while the MD recorder is in stop mode.



- 2 Select the save destination title memo ([1], [2] or [3]).

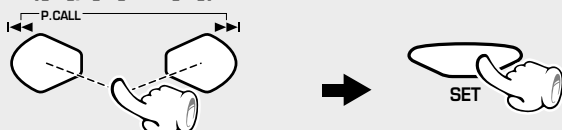

- 3 Enter the skip mode.

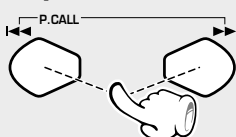

- 4 Select the title group [123] containing the copy source title.

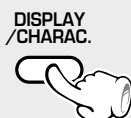

- 5 Select the disc or track title to be copied.

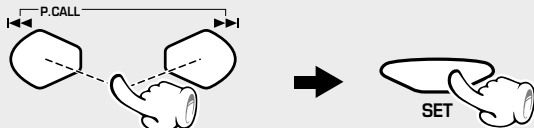

- 6 Save it in the save destination title memo.



- 7 Press the **TITLE INPUT** key to complete editing.



- 8 Press the **MD** key and eject the MD.

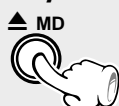

- To cancel TITLE COPY in the middle, press the **TITLE INPUT** key on the remote.

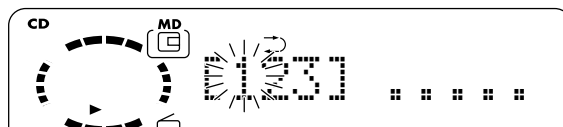
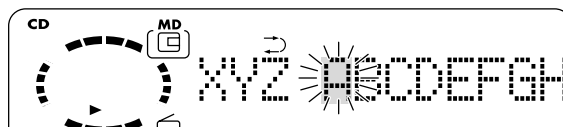

- Press the **DISPLAY/CHARAC.** key repeatedly until title memo selection menu appears.
- If a title memo has already been input, that title memo is displayed.
- It is also possible to copy additional titles to the same title memo by repeating steps 5 after step 5.
- To copy other titles in other title memos, repeat steps 2 to 6 for each title.

Entering characters in title memo (TITLE MEMO)

- 1 Press the **TITLE INPUT** key while the MD recorder is in stop mode.



- 2 Select the save destination title memo ([1], [2] or [3]).

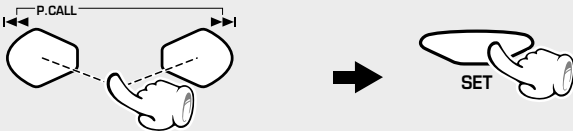

- 3 Enter characters as described in procedure step 2 of "Assigning a title to a disc or track".

- 4 Press the **ENTER** key to copy the characters in the title memo.



- 5 Press the **TITLE INPUT** key to complete editing.



- 6 Press the **▲ MD** key and eject the MD.



- To cancel TITLE MEMO in the middle, press the **TITLE INPUT** key on the remote.

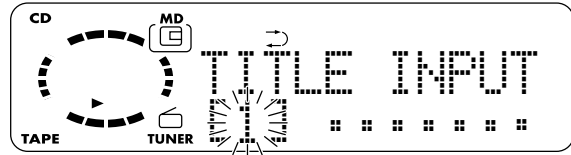

- To enter characters in other title memos, repeat steps 2 to 4 for each character set.

Always eject the MD after title entry or editing.

Copying title memo contents as the title of another disc or track

This editing operation is available by exchanging the parties (copy destination and copy source) in the procedure of "Copying a Disc or Track Title in a Title Memo (TITLE COPY)". - 55

After performing steps 1 to 6 in the procedure on page 55, change steps 2 and 5 as shown below. The input can be repeated by simply performing these two steps.

Step 2 Select a disc or track title as the destination in place of the title memo.

Step 5 Select a title memo 1 to 3 as the copy source.

Tone adjustment

The lowest and highest frequency bands can be adjusted independently. (Remote control only)

1 Select the frequency band.



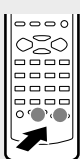

(Go to step 2 within 20 seconds.)

2 Adjust.



(To adjust the other frequency band, repeat steps 1 and 2 for it.)

Each press switches the operation.

- ① "BASS" (low frequency) adjustment

- ② "TREBLE" (high frequency) adjustment

- ③ Normal mode

- The levels of both "BASS" and "TREBLE" can be adjusted in 2 steps in the range between -8 and +8.
- Adjusting the tone while the "LOUD" or "EX.BASS" indicator is lit turns it off and cancels the sound enhancement mode.

Balance adjustment (Adjust for the desired left / right balance.)

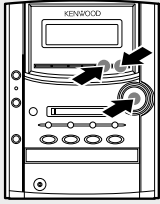
Adjusts the balance of left and right volume. (Main unit operation only)

1 Select "BALANCE ?".



menu

set/demo

volumes/multi control

up

down

(Press the set/demo key while the "?" mark is blinking.)

Turning the knob switches the display contents.

- TAPE RVS.
- REC. MODE
- A.MEMORY ? (or AUTO PRESET)
(Only when the TUNER input is selected)
- AUX INPUT ?
(Only when the AUX input is selected)
- BALANCE ?**
- BACK LIGHT ?
- A.P.S. SET ?
- TIMER SET ?

2 Adjust.

1 Adjust.

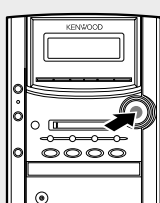

volumes/multi control

up

down

The right volume is decreased.

The left volume is decreased.

2 Set it.



set/demo

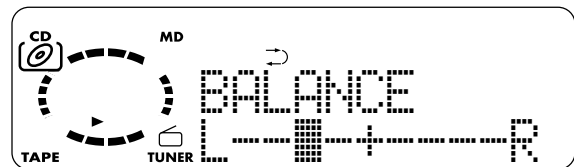

Listening to an AUX input source

1 Select AUX (external input).

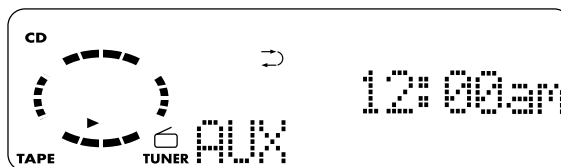
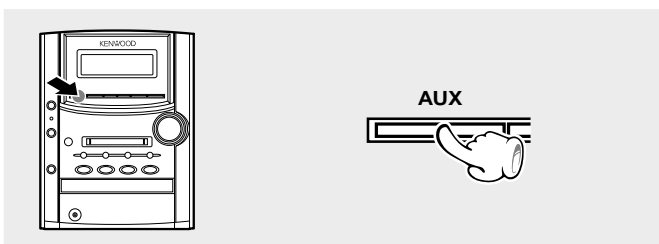

2 Play the connected equipment.

3 Adjust the volume.

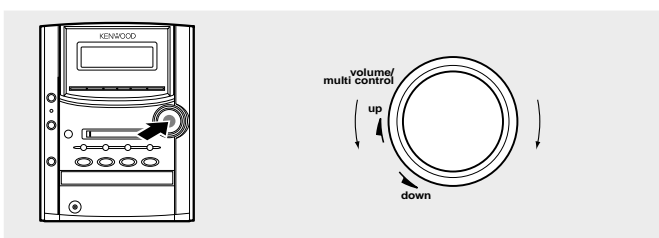

Adjusting the AUX Input Level

This adjusts the input level for the external equipment (video deck etc.) connected to the AUX input terminal. Adjust so that the volume of the AUX input source sounds at an equivalent level to the CD or MD. (Main unit operation only)

1 Select "AUX INPUT ?" menu

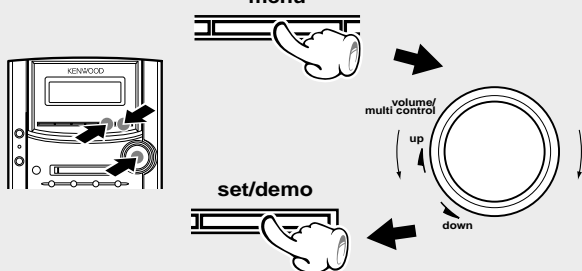

2 Adjust the input level.

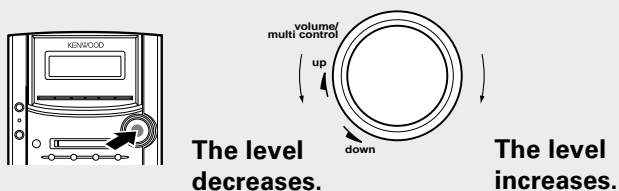

3 Set it

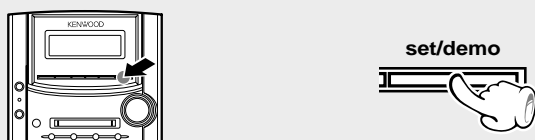

Turning the knob switches the display contents.

TAPE RVS.	?
REC MODE	?
AUX INPUT	?
BALANCE	?
BACK LIGHT	?
A.P.S. SET	?
TIMER SET	?

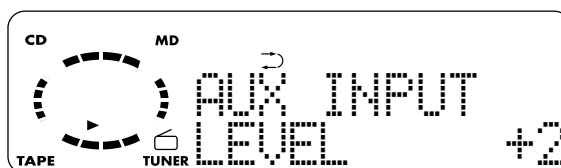

- Adjust the input level while "AUX INPUT" is displayed.
- Adjustment is possible over the range from -4 to +3.
- Adjusting the input level control also varies the recording level from the input source connected to the AUX input jacks.

As the clock is not used to show the time of the day but is also used in timer operations, be sure to set the clock in advance.

1 Activate the clock adjustment mode.

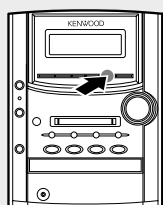

Press and hold for more than 2 sec. when the power is ON.

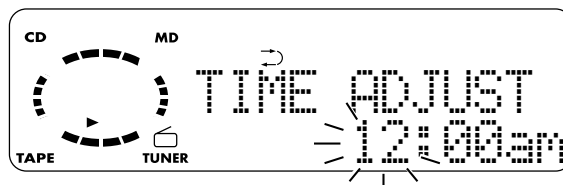
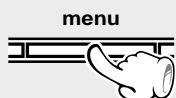

- The time display starts to blink.

2 Enter the figure of hour.

1 Enter the figure of hour.

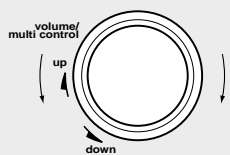

To decrease hour

To increase hour

2 Set it.

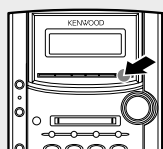

Example: Adjustment to 8:07

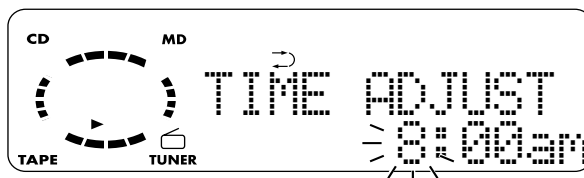

- The time of the day is represented in 12-hour am/pm method.
- Press the **set/demo** key. The hour is entered and the minute display starts to blink.

3 Enter the figure of minute.

1 Enter the figure of minute.

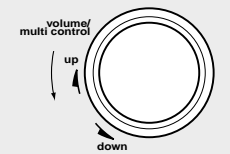
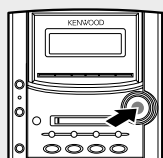

To decrease minute

To increase minute

2 Set it.

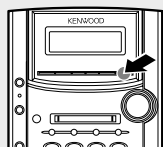

Example: Adjustment to 8:07

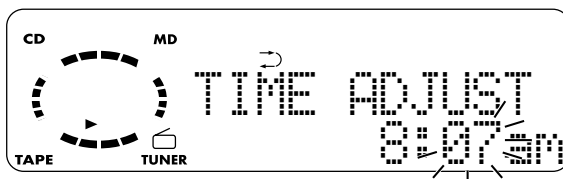

- If you make a mistake, restart from the beginning.
- When the time of day has been set by pressing the **set/demo** key, the display shows "COMPLETE".
- After a power failure or the power cord has been unplugged then plugged in again, it is required to set the time again.
- When the **STOP** key is pressed while the power is in the standby mode, the time of the day will be displayed for 5 seconds.

Operate easy To use Timer (O.T.T.)

Playback of the selected input source starts at the specified time, and the unit is switched off after one hour. This timer operates only once directly after setting.

Timer playback, timer recording (PROG.1, PROG.2)

With each of the two timer programs, a selected source can be played (or radio broadcast can be recorded) in the previously set time period.

AI timer playback (PROG.1, PROG.2)

When timer playback starts, the volume level increases gradually until a certain level is reached.

Sleep timer (SLEEP)

The unit is turned OFF automatically after the specified period has elapsed.

Adjust the clock before setting the timer. →  59

Connect the related equipment under reference to "System connection".

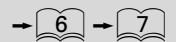

Setting the O.T.T. timer

Timer playback which occurs only once and only for an hour can be programmed by simply setting the start time. The timer playback reproduces the source selected at the last time the unit is turned off at the last set volume.

- ① Press the menu key.
- ② Rotate the volume/multi control knob to select "TIMER SET?".

- ③ Press the set/demo key.

- ④ Rotate the volume/multi control knob to select "O.T.T. SET?".

- ⑤ Press the set/demo key to set "O.T.T. SET?".

- ⑥ Rotate the volume/multi control knob to select the time of the day to start playback or tuning (ON time).

- ⑦ Press the set/demo key to set the ON time.

⑧ Reserve the timer operation.

- Press the remote's **TIMER** key repeatedly until "O.T.T." lights up.
- When the O.T.T. timer is set while the PROG.1 or PROG.2 timer has been set, the reservation by the PROG.1 or PROG.2 timer is canceled.

⑨ Press the **POWER (I/⏻)** key to turn power off (STANDBY).

- The standby/timer indicator lights in amber in the standby mode.

Turning the knob switches the display contents.

→	TAPE RVS.	?
→	REC MODE	?
→	A.MEMORY	? (or AUTO PRESET)
→	(Only when the TUNER input is selected)	
→	AUX INPUT	?
→	(Only when the AUX input is selected)	
→	BALANCE	?
→	BACK LIGHT	?
→	A.P.S. SET	?
→	TIMER SET	?

Turning the knob switches the display contents.

→	① O.T.T. SET	?
→	② PROG. 1 SET	?
→	③ PROG. 2 SET	?

- The ON time can be set in steps of 5 minutes.

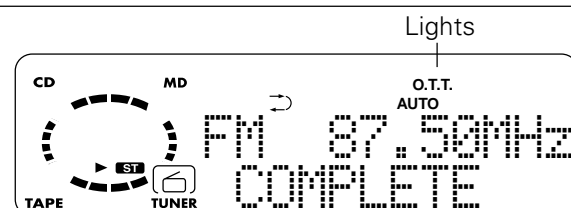

- After the timer has been set and power is off (timer standby), if there is a power failure or the power cord is unplugged from and plugged again into the power outlet, the standby/timer indicator blinks in amber. In this case, set the clock again.

Setting an everyday timer program (PRG. TIMER)

In each of PROG.1 and PROG.2, the timer data including the operating period and played contents can be set and selected to be activated or not as required.

Adjust the clock before setting the timer. → [59](#)

1 Make preparations for the play (recording).

To listen to CD

Insert a disc.
(Program playback is not possible.)

To listen to MD

Load a disc.
(Program playback is not possible.)

To listen to tape

Set a tape into.

To listen to radio

The station should be preset prior to the above. → [24](#)

Playing the auxiliary input source

Make timer setting of the component connected to the AUX input jacks.

For recording

Make preparations for recording.

MD → [28](#)

TAPE → [30](#)

- Timer reservation is possible for the two types PROG.1 and PROG. 2 at the same time.
- Please make reservations with an interval of at least one minute, so that the operation times of PROG. 1 and PROG. 2 do not overlap.

2 Select the timer number.

① Select "TIMER SET ?".

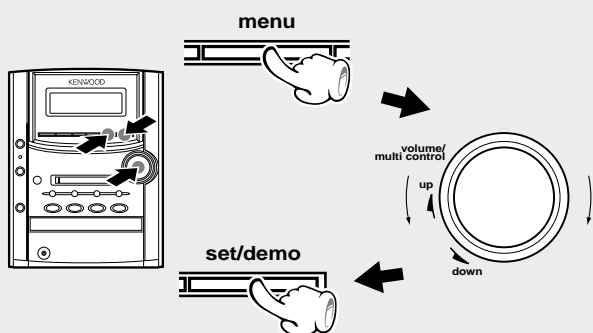

(Press the set/demo key while the "?" mark is blinking.)

② Select "PROG. 1 SET ?" or "PROG. 2 SET ?".

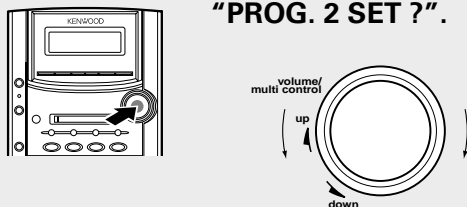

③ Set it.



(Press during display of the program contents.)

Turning the knob switches the display contents.

TAPE RVS.	?
REC MODE	?
A.MEMORY ? (or AUTO PRESET)	(Only when the TUNER input is selected)
AUX INPUT	?
(Only when the AUX input is selected)	
BALANCE	?
BACK LIGHT	?
A.P.S. SET	?
TIMER SET	?

Turning the knob switches the display contents.

① O.T.T. SET	?
② PROG. 1 SET	?
③ PROG. 2 SET	?

- The selected timer number lights.
- If the selected timer number has a previously set program with it, the program will be overwritten by the newly set program.
- The previously set contents are displayed. (If you do not want to change them, simply press the **set/demo** key.)

Continued on next page

3 Set the ON time then the OFF time.

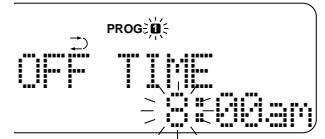
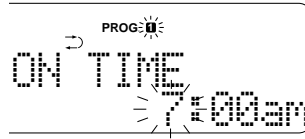
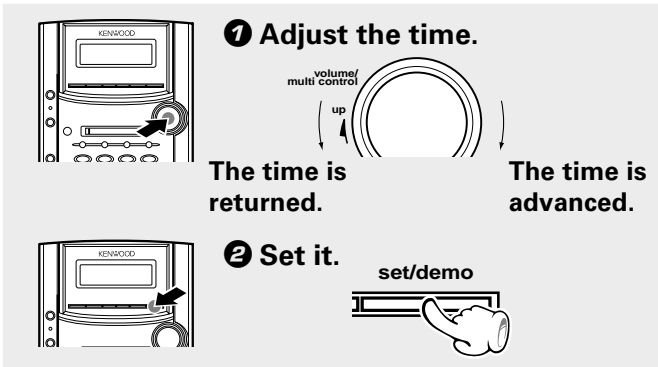

- For each of the ON time and OFF time, enter the figure of "hour" by performing steps **1** and **2** then enter the figure of "minute" in the same manner.
- If you make a mistake, press the **menu** key and restart from step **3**.

4 Make the desired reservation.

For timer playback or AI timer playback

1 Select the mode.

(1) Select "PLAY" or "AI PLAY".
(2) Enter it.

① **PLAY** Timer play
② **REC**
③ **AI PLAY** Timer play with gradually increasing volume

2 Select the input source.

(1) Select the source to be played.
(2) Enter it.

① **TUNER** Broadcasts
② **CD**
③ **MD**
④ **TAPE**
⑤ **AUX** External input (video, etc.)

- To select AUX, rotate the **volume/multi control** knob counterclockwise.

3 Select the broadcast station (only when TUNER is selected above).

(1) Select the preset station No.
(2) Enter it.

- When the timer setting is completed by pressing the **set/demo** key, "COMPLETE" is displayed.
- The source is played back at the volume set the last time the power was turned off.

For timer recording

1 Select the mode.

(1) Select "REC".

① **PLAY**
② **REC**
③ **AI PLAY**

(2) Enter it.

2 Select the input source.

(1) Select what is to be recorded.

① **TUNER** Broadcasts
② **AUX** External input

(2) Enter it.

3 Select the broadcast station (only when TUNER is selected above).

(1) Select the preset station No.
(2) Enter it.

4 Select the broadcast station (only when TUNER is selected above).

(1) Select.

① **MD**
② **TAPE**

(2) Enter it.

- When the timer setting is completed by pressing the **set/demo** key, "COMPLETE" is displayed.
- The sound is muted during timer recording. If you want to monitor the recorded sound, turn the **volume/multi control** knob (or press the **volume** key on the remote) to adjust the volume.

5 Reserve the timer operation.

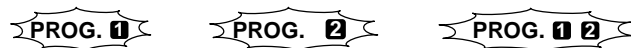

- Press the **TIMER** key on the remote repeatedly until "PROG. 1", "PROG. 2" or "PROG. 1 2" lights.

6 Put the unit in standby mode.

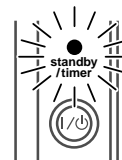
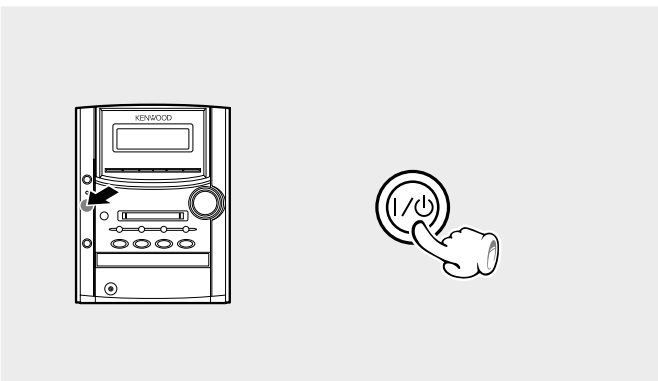

- The standby/timer indicator lights in amber in the standby mode.
- After the timer has been set and power is off (timer standby), if there is a power failure or the power cord is unplugged from and plugged again into the power outlet, the standby/timer indicator blinks in amber. In this case, set the clock again.

When timer operation is not required

When power is ON, press the **TIMER** key to turn off the timer-related indicators completely.

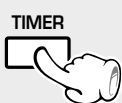

Each press switches the timer as follows.

- ① O.T.T.
- ② PROG. 1
- ③ PROG. 2
- ④ PROG. 1 2
- ⑤ Extinguished

- The reservation contents are held in memory.

To set the same timer program again

When power is ON, press the **TIMER** key to turn off the timer-related indicators completely.

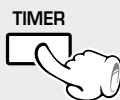

Each press switches the timer as follows.

- ① O.T.T.
- ② PROG. 1
- ③ PROG. 2
- ④ PROG. 1 2
- ⑤ Extinguished

- Be sure to load a disc or tape and adjust the listening volume.



To check or modify the reservation contents, restart the timer reservation from the beginning.

Sleep timer (SLEEP)

Set the number of minutes after which the unit is to be turned OFF.

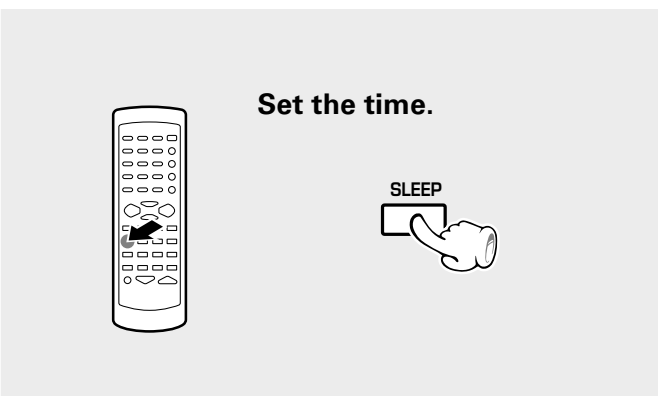

Set the time.

- The unit is turned OFF automatically after the set time has elapsed.
- Each press increases the timer period by 10 minutes. The sleep timer can be set up to 90 minutes.

10→20→30...70→80→90→Cancel→10→20...

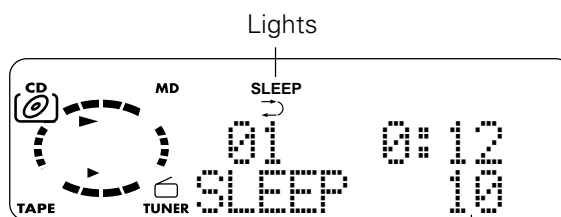

Duration for sleep timer

To cancel

Turn the unit OFF or press the **SLEEP** key until the sleep time is cancelled.

Maintenance

Cleaning the head section

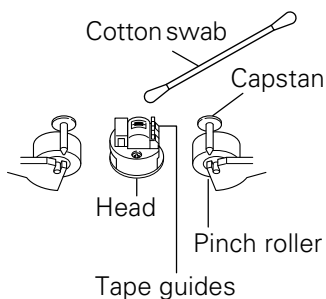

Cleaning the heads and peripheral components

For maintaining the best condition of the deck and for longer service life, always keep the heads (recording / playback / erase), capstan and pinch roller clean. To clean them, perform the following:

1. Open the cassette holder.
2. Using a cotton swab dipped in alcohol, clean the head (recording / playback / erase), capstan and pinch roller carefully.

Demagnetizing the head

When the recording / playback head is magnetized, the sound quality will deteriorate. In such a case, demagnetize the head using a commercially available demagnetizer (head eraser).



There are precisely aligned parts around the heads, including the tape guides. When cleaning, pay special attention so as not to apply shock to them.

Maintenance of the unit

When the front panel or case becomes dirty, wipe with a soft, dry cloth. Do not use thinner, benzene, alcohol, etc. for these agents may cause discoloration.

In regard to contact cleaner

Do not use contact cleaners because it could cause a malfunction. Be specially careful not to use contact cleaners containing oil, for they may deform the plastic component.

Note related to transportation and movement

Before transporting or moving this unit, carry out the following operations.

- ① Remove the CD or MD from the unit.
- ② Press the MD ►/II key.

MD NO DISC

- ③ Press the CD ►/II key.
- ④ Wait for some time and verify that the display becomes as shown in the figure.

CD NO DISC

- ⑤ Wait a few seconds and turn the unit OFF.

US and foreign patents licensed from Dolby Laboratories.

Caution on MD-Clip data

Do not attempt to record or edit a disc in which MD-Clip data (still images, etc.) have been recorded. Otherwise, the Clip data may be lost.

Memory backup function

Stored contents which are cleared immediately when power plug is unplugged from power outlet	Clock display MD recorder section
Stored contents which are cleared in at least a day after power plug is unplugged from power outlet	Amplifier section "on/standby" status (ON or STANDBY) Last input selection Volume control value Tone control levels AUX input level Balance setting Setting auto power save Tuner section Receiving band Frequency Preset stations Auto/mono setting Timer setting contents Cassette deck unit Transport direction Tape EQ. Reverse mode

Memory Backup for the MD Recorder Section

The contents of the memory are not stored on the disc if the power cord is unplugged.

If there is a power failure or if the power cord is unplugged, the recording or editing information (normally recorded when the minidisc is removed) may be erased or destroyed before it is recorded on the minidisc. Once the information has disappeared, it can not be recovered.

After recording or editing, always remove the minidisc to record the recording or editing information.

Disc handling precautions

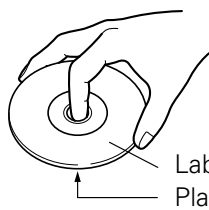

Handling

Hold the discs so that you do not touch the playing surface.

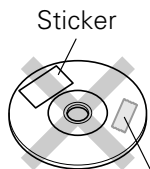

Do not attach paper or tape to either the playing side or the label side of the discs.

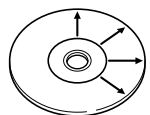

Cleaning

If fingerprints or foreign matter become attached to the disc, lightly wipe the disc with a soft cotton cloth (or similar) from the center of the disc outwards in a radial manner.

Storage

When a disc is not to be played for a long period of time, remove it from the player and store it in its case.

Discs which can be played with this unit

CD (12 cm, 8 cm), and the audio part of CDV, CD-G, CD-EG and CD-EXTRA.

Use discs that comply with the IEC standard, for example a disc carrying the  marking on the label surface.

Never play a cracked or warped disc

During playback, the disc rotates at high speed in the player. Therefore, to avoid danger, never use a cracked or deformed disc or a disc repaired with tape or adhesive agent. Please do not use discs which are not round because they may cause a malfunction.

Disc accessories

The disc accessories (stabilizer, protection sheet, protection ring, etc.) which are marketed for improving the sound quality or protecting discs as well as the disc cleaner should not be used with this system because they may cause malfunction.

As the Mini Disc is accommodated inside a cartridge, it can be handled without caring about dust or fingerprint. However, stained or soiled cartridge may cause malfunction. To enjoy beautiful sound for extended period of time, take care on the following points.

Do not touch the disc directly.

Do not touch the disc by opening the shutter with your hand. The cartridge will be damaged if it is forced open.

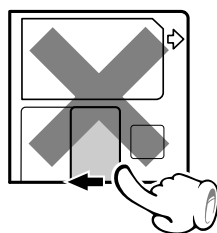

Storage position

Do not leave Mini Discs in place where the temperature and/or humidity are extremely high (for example, in a place subject to direct sunlight).

Dust countermeasure

The shutter of the disc cartridge is permanently open while the disc is loaded in the set. Therefore, to prevent dust from penetrating inside the disc, take the disc out of the unit immediately after completion of recording or playback.

Note on disc accessories

Do not use the lens cleaner for this may lead to malfunction of the unit.

Care

Wipe periodically dust and dirt attached on the cartridge with a dry cloth.

Write protect tab

To protect recorded contents against accidental erasure, set the write protect tab of the disc open. Return the tab to the original position when you want to record signals on the disc.

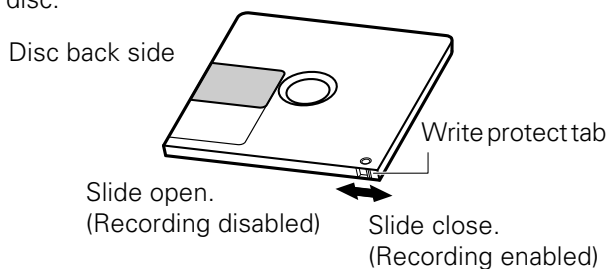

Note on disc accessories

Do not use the lens cleaner for this may lead to malfunction of the unit.

Note on the cartridge labels

Apply each label firmly to every corner so that it will not be peeled off.

Safety tab (accidental erasure prevention tab)

After an important recording has been finished, break the safety tab, to prevent the recorded contents from being erased or recorded on accidentally.

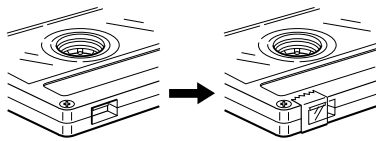
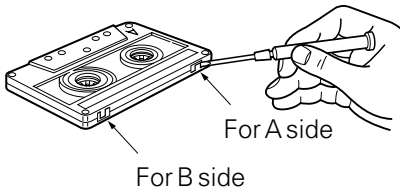
**To re-record**

Apply tape only to the position where the tab has been removed.

To store cassette tapes

Do not store the tapes in a place which is subject to direct sunlight, or near equipment that generates heat. Keep the cassette tapes away from any magnetic field.

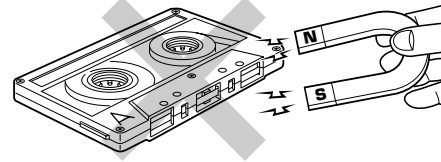
**When there is slack in the tape**

In such a case, insert a pencil into the reel hole and wind the reel hub to remove the slack.

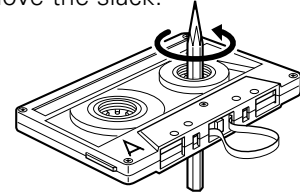
**1. Longer tape than 90 minutes cassette tape**

Do not use a cassette with more than 90-minute recording time, for the tape used with such a cassette is very thin and tends to cause troubles such as entanglement around the pinch roller or cutting of tape.

2. Endless tapes

Do not use an endless tape, as this could damage the mechanism of the unit.

Reference

Caution on condensation

Condensation (of dew) may occur inside the unit when there is a great difference in temperature between this unit and the outside.

This unit may not function properly if condensation occurs. In this case, leave the unit for a few hours with the power left ON, and restart the operation after the condensation has dried up.

Be specially cautious against condensation in a following circumstance:

When this unit is carried from a place to another across a large difference in temperature, when the humidity in the room where this unit is installed increases, etc.

WARNING NOTICE:

IN MOST CASES IT IS AN INFRINGEMENT OF COPYRIGHT TO MAKE COPIES OF TAPES OR DISCS WITHOUT THE PERMISSION OF THE COPYRIGHT OWNERS. ANYONE WISHING TO COPY COMMERCIALY AVAILABLE TAPES OR DISC SHOULD CONTACT THE MECHANICAL COPYRIGHT PROTECTION SOCIETY LIMITED OR THE PERFORMING RIGHTS SOCIETY LIMITED.

Designed for copyright protection, the SCMS is a prescription that copying of digital signals as they are in the digital form between digital audio equipment is allowable only for one generation.

Digital recording is not available with commercially marketed music software (CD, MD, etc.) containing the copy prohibit code.

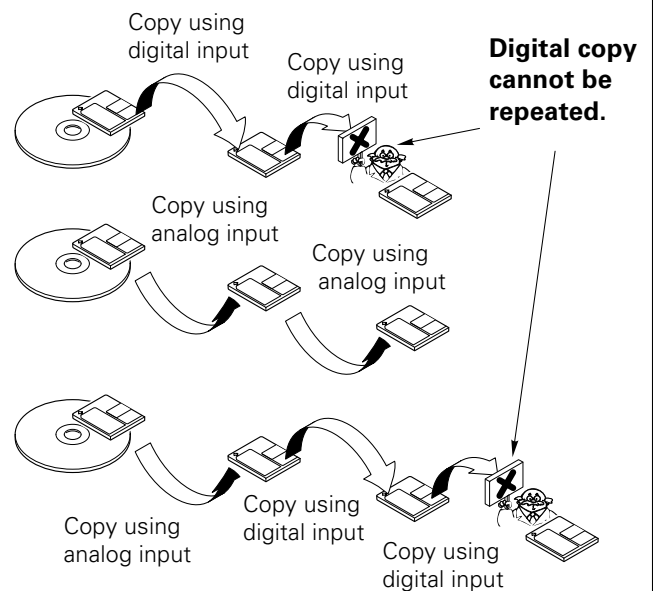

What seems to be a malfunction is not always so. Before calling for service, check the following table according to the symptom of your trouble.

Operation to reset

The microcomputer may fall into malfunction (impossibility to operate, erroneous display, etc.) when the power cord is unplugged while unit is ON or due to an external factor. In this case, execute the following procedure to reset the microcomputer and return it to normal condition.

- Please note that resetting the microcomputer clears the contents stored in and it returns to condition when it left the factory.

Unplug the power cord from the power outlet then, while holding the set/demo key depressed, plug the power cord again.

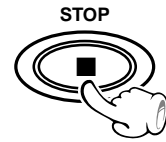
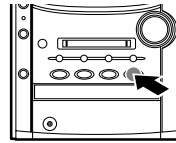

Amplifier section/Speakers

Symptom	Remedy
Sound is not produced.	<ul style="list-style-type: none"> ● Connect properly referring to "System connections". → 6 ● Adjust to an required volume. → 15 ● Switch MUTE OFF. → 15 ● Unplug the headphone plug.
standby/timer blinks and no sound is put out.	<ul style="list-style-type: none"> ● A speaker cord is short-circuited. Turn power off and re-connect the speaker cord.
The standby/timer indicator lights in amber.	<ul style="list-style-type: none"> ● Adjust the present time again. → 59
No sound from the headphones.	<ul style="list-style-type: none"> ● Insert correctly. → 15 ● Adjust to an required volume.
Sound is not produced from the left or right speakers.	<ul style="list-style-type: none"> ● Connect properly referring to "System connection". → 6 ● Adjust the optimum left and right balance. → 57
The clock display blinks without changing the figures.	<ul style="list-style-type: none"> ● Adjust the present time again. → 59
Timer operation is not possible.	<ul style="list-style-type: none"> ● Adjust the present time referring to "Clock adjustment". → 59 ● Set the timer ON time and OFF time. → 62 ● Press the TIMER key to set up the execution. → 63

Tuner section

Symptom	Remedy
Radio stations cannot be received.	<ul style="list-style-type: none"> ● Connect antennas. → 6 ● Select a band. → 24 ● Tune to the frequency of the desired station. → 24
Noise interferes.	<ul style="list-style-type: none"> ● Install the outdoor antenna in an apart position from the road. ● Switch the suspected electric appliance OFF. ● Install the TV or the system at an increased distance between them.
A station has been preset but it cannot be received by pressing the PCALL key.	<ul style="list-style-type: none"> ● Preset stations with tunable frequencies. → 24 ● Preset stations again. → 24

Symptoms related to MD standard

Symptom	Cause
"DISC FULL" is displayed while the disc still has a remaining recordable time.	<ul style="list-style-type: none"> More than 255 tracks (track No. 256 or more) cannot be recorded. (There may be also cases in which recording is impossible while the track number is less than 256.) In such a case, the REMAIN time display shows "0:00".
The possible recording time does not increase even when a short track is erased.	<ul style="list-style-type: none"> When the remaining time of the entire disc is less than 12 sec, the remaining time indication on the display becomes "0:00". When the total time of the deleted tracks exceeds 12 sec, the display changes to the recordable time. When a short track is deleted on a repeatedly edited disc, the remaining time may not increase.
Tracks can not be connected.	<ul style="list-style-type: none"> Connection of the track resulting from edit processing may not be possible.
The time which has been recorded on the MD and the remaining time do not add up to the maximum recording time (60 or 74 min.).	<ul style="list-style-type: none"> As recording is executed with 2 sec. as the minimum unit, the display time may not coincide.
When search is performed in a track which has been compiled by editing, the sound is sometimes interrupted.	<ul style="list-style-type: none"> This derives from the restriction in the MD system standard and not a malfunction.
The track numbers are not assigned correctly.	<ul style="list-style-type: none"> Depending on the contents of the recorded source (CD etc.), the track numbers may not be assigned correctly.
"READING" is displayed for an abnormally long time.	<ul style="list-style-type: none"> When a new recordable MD (with nothing recorded) is inserted, "READING" is displayed longer than usual.
The time display becomes inaccurate with a monaurally recorded disc.	<ul style="list-style-type: none"> Monaural recording and stereo recording are executed according to different formats. This is not a malfunction.
Input of 1792 title characters is not possible.	<ul style="list-style-type: none"> The title recording area is used in units of 7 characters, so that input of 1792 characters may not be possible.

MD recorder section (other symptoms)

Symptom	Remedy
Sound is not output even when the play key is pressed.	<ul style="list-style-type: none"> Load a prerecorded disc or playback-only disc.
Recording is not possible	<ul style="list-style-type: none"> Change the position of the write protect tab to the write position or use a recordable disc. → 64 Recording is not possible. Adjust the AUX input level. → 58 Set the input selector to the source to be recorded.
Sound is distorted.	<ul style="list-style-type: none"> Adjust the AUX input level. → 58
Noise is noticeable.	<ul style="list-style-type: none"> Install the unit at a position apart from an electric appliance or TV set.

MD recorder section (Displayed messages and actions to be taken against them)

Displayed Message	Meaning	Action
NO DISC	<ul style="list-style-type: none"> No disc is placed on the tray. 	<ul style="list-style-type: none"> Load a disc.
CAN'T COPY	<ul style="list-style-type: none"> An attempt is made to record digital signal from a source while its digital copy has been prohibited by SCMS. An attempt is made to record a CD containing recording of non-audio digital signal. 	<ul style="list-style-type: none"> This unit cannot record this kind of signal. This unit cannot record this kind of signal.
DISC FULL	<ul style="list-style-type: none"> There is no recordable area on the disc. An attempt is made to record a 256th track. 	<ul style="list-style-type: none"> Use another recordable disc. More than 256 tracks cannot be recorded per disc. (There may be also cases in which recording is impossible while the track number is less than 256.)
TITLE FULL	<ul style="list-style-type: none"> An attempt is made to assign a title with more characters than usable. 	<ul style="list-style-type: none"> Refer to "Total number of title characters".
BLANK DISC	<ul style="list-style-type: none"> The disc does not contain any recordings. 	<ul style="list-style-type: none"> When playback is required, use a recorded disc.
NO TRACKS	<ul style="list-style-type: none"> The disc does not contain any tracks but has a disc title. 	<ul style="list-style-type: none"> The disc can be used for recording without any problem.
READING	<ul style="list-style-type: none"> The TOC ^{*1} data of the disc is being read. 	<ul style="list-style-type: none"> This is a normal operation.
WRITING	<ul style="list-style-type: none"> The data related to editing or recording is being written in the disc. 	<ul style="list-style-type: none"> This is a normal operation.
DISC ERROR	<ul style="list-style-type: none"> The contents of UTOC ^{*2} are abnormal. 	<ul style="list-style-type: none"> Perform "ALL ERASE" operation. If this is not possible, use another disc.
CAN'T EDIT	<ul style="list-style-type: none"> An attempt is made to perform editing beyond the restrictions, for example to erase a track which is too short. 	<ul style="list-style-type: none"> Perform editing following the restrictions.
?(blinking)	<ul style="list-style-type: none"> This is a message for confirming if editing can really be executed. 	<ul style="list-style-type: none"> Press the ENTER key to execute editing.
PROTECTED	<ul style="list-style-type: none"> The minidisc is write-protected. 	<ul style="list-style-type: none"> Cancel the write protection.
PLAY ONLY	<ul style="list-style-type: none"> The minidisc is only for playback. 	<ul style="list-style-type: none"> Insert a minidisc for recording.
UNIT ERROR	<ul style="list-style-type: none"> This indicates some trouble. 	<ul style="list-style-type: none"> Return to normal condition is made by switching the unit off and then on again.
PLEASE WAIT	<ul style="list-style-type: none"> An attempt is made to record a CD with double-speed recording within 74 minutes after the same CD was recorded with double-speed recording. 	<ul style="list-style-type: none"> Wait until the displayed time elapses before starting double-speed recording.

*1 All minidiscs contain a Table of Contents (TOC) in addition to sound signals. The TOC is similar to the table of contents in a book and contains information, such as track numbers, track length, and character information, that cannot be rewritten.

*2 In addition to the TOC, minidiscs also contain a special User's Table of Contents (UTOC) that contains track number, track length, and character information, that can be rewritten.

CD player section

Symptom	Remedy
A CD is placed in the player but it cannot be played.	<ul style="list-style-type: none"> Place the disc properly, with the label side facing upward. Clean the disc referring to "Disc handling precautions". → 65 Refer to "Caution on condensation" and remove the condensation by evaporation. → 66
Sound is not produced.	<ul style="list-style-type: none"> Press the CD ►/ key. Clean the disc referring to "Disc handling precautions". → 65
Sound skips.	<ul style="list-style-type: none"> Clean the disc referring to "Disc handling precautions". → 65 Install the unit in a place not subject to vibrations.

Remote control unit

Symptom	Remedy
Remote control operation is not possible.	<ul style="list-style-type: none"> Replace with new batteries. → 13 Operate the unit inside the remote controllable range. → 13

Cassette deck

Symptom	Remedy
Sound cannot be produced by pressing the play key.	<ul style="list-style-type: none"> Clean the head referring to "Maintenance". → 64 Play a recorded tape.
No operation occurs even when an operation key is pressed.	<ul style="list-style-type: none"> Press operation keys in more than a few seconds after closing the cassette holder. Change the tape transport direction or reverse the tape insertion orientation. → 22
The cassette holders cannot be opened by pressing the TAPE ▲ key.	<ul style="list-style-type: none"> Press in stop mode.
Sound is harsh or high frequencies are not reproduced.	<ul style="list-style-type: none"> Clean the head referring to "Maintenance". → 64 Try another tape.
Sound is distorted.	<ul style="list-style-type: none"> Adjust the AUXinput level. → 58
Noise is noticeable.	<ul style="list-style-type: none"> Demagnetize the head referring to "Maintenance". → 64 Install the system at a distance from other electric appliances and TV. Set the "TAPE EQ." to on. → 23
Sound vibrates.	<ul style="list-style-type: none"> Clean the head referring to "Maintenance". → 64 Wind the tape again by fast forwarding, rewinding or playing from an end to the other. → 22 → 23
Recording cannot be started by pressing the record key.	<ul style="list-style-type: none"> Use a cassette with an unbroken recording protect tab or block the hole. → 66 Set the input selector to the source to be recorded. → 14 Change the tape transport direction or reverse the tape insertion orientation. → 22

Main unit

[Amplifier section]

(For U.K. and Europe)

Effective output power during STEREO operation
1 kHz, 10 % T.H.D., at 6 Ω 20 W + 20 W

Rated output power during STEREO operation
1 kHz, 0.7 % T.H.D., at 6 Ω 15 W + 15 W

(For other countries)

Rated output power during STEREO operation
1 kHz, 10 % T.H.D., at 6 Ω 20 W + 20 W

Frequency response
AUX 50 Hz~50 kHz (0 dB ~ -3dB)

[Tuner section]

FM tuner section

Tuning frequency range 87.5 MHz ~ 108 MHz

MW (AM) tuner section

(For U.K. and Europe)

Tuning frequency range 531 kHz ~ 1,602 kHz

(For Australia)

Tuning frequency range 531 kHz ~ 1,602 kHz

(For other countries)

Tuning frequency range
9 kHz step 531 kHz ~ 1,602 kHz
10 kHz step 530 kHz ~ 1,610 kHz

[MD recorder section]

Laser Semiconductor laser
Recording method Field modulation overwrite method
D/A Conversion 1 Bit
Wow & flutter Less than unmeasurable limit

[CD player section]

Laser Semiconductor laser
D/A Conversion 1 Bit
Wow and flutter Less than unmeasurable limit

[Cassette deck section]

Track 4-track, 2-channel stereo
Recording system AC bias system
(Frequency: 65 kHz)

Heads

Playback / recording head 1
Erasing head 1

Motors 1

Wow and flutter 0.2 % (W.R.M.S.)
Fast winding time Approx. 100 seconds
(C-60 tape)

[General]

Power consumption 60 W
Dimensions
W : 180 mm
H : 239 mm
D : 305 mm

Weight (net) 5.7 kg

Speakers

Enclosure Book shelf type, magnetically shielded

Speaker configuration

Woofer 100 mm, cone type

Tweeter 50 mm, cone type

Impedance 6 Ω

Maximum input level 30 W

Dimensions
W : 150 mm

H : 234 mm

D : 197 mm

Weight (net) 2.4 kg(1 piece)



KENWOOD follows a policy of continuous advancements in development. For this reason specifications may be changed without notice.

- Sufficient performance may not be exhibited at extremely cold locations (where water freezes).

KENWOOD

For your records

Record the serial number, found on the back of the unit, in the spaces designated on the warranty card, and in the space provided below. Refer to the model and serial numbers whenever you call upon your dealer for information or service on this product.

Model _____ Serial Number _____

Free Manuals Download Website

<http://myh66.com>

<http://usermanuals.us>

<http://www.somanuals.com>

<http://www.4manuals.cc>

<http://www.manual-lib.com>

<http://www.404manual.com>

<http://www.luxmanual.com>

<http://aubethermostatmanual.com>

Golf course search by state

<http://golfingnear.com>

Email search by domain

<http://emailbydomain.com>

Auto manuals search

<http://auto.somanuals.com>

TV manuals search

<http://tv.somanuals.com>