

KENWOOD

TK-90

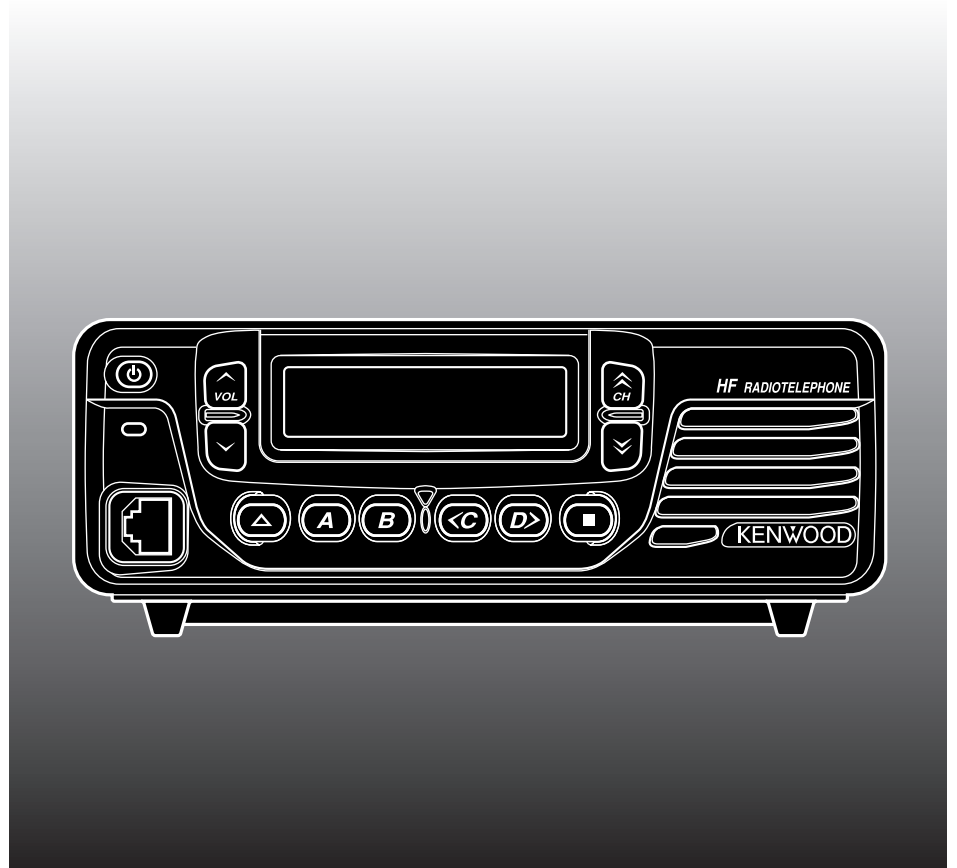

HF TRANSCEIVER

# INSTRUCTION MANUAL

TRANSCEPTOR HF

# MANUAL DE INSTRUCCIONES

短波对讲机

# 使用说明书

Kenwood Corporation

© B62-1866-10 (M)

09 08 07 06 05 04 03 02 01

HF TRANSCEIVER

# TK-90

## INSTRUCTION MANUAL

---

Kenwood Corporation

ENGLISH

## THANK YOU

Thank you for choosing **KENWOOD** for your radio telecommunication applications. We believe this easy-to-use transceiver will provide dependable communications to keep vehicles and personnel operating at peak efficiency.

**KENWOOD** transceivers incorporate the latest in advanced technology. As a result, we feel strongly that you will be pleased with the quality and features of this product.

## NOTICES TO THE USER

- ◆ Government law prohibits the operation of unlicensed transmitters within the territories under government control.
- ◆ Illegal operation is punishable by fine and/or imprisonment.
- ◆ Refer service to qualified technicians only.

**SAFETY:** It is important that the operator is aware of, and understands, hazards common to the operation of any transceiver.

### **WARNING**

- ◆ **EXPLOSIVE ATMOSPHERES (GASES, DUST, FUMES, etc.)**  
Turn OFF your transceiver while taking on fuel or while parked in gasoline service stations. Do not carry spare fuel containers in the trunk of your vehicle if your transceiver is mounted in the trunk area.
- ◆ **INJURY FROM RADIO FREQUENCY TRANSMISSIONS**  
Do not operate your transceiver when somebody is either standing near to or touching the antenna, to avoid the possibility of radio frequency burns or related physical injury.
- ◆ **DYNAMITE BLASTING CAPS**  
Operating the transceiver within 150 m (500 feet) of dynamite blasting caps may cause them to explode. Turn OFF your transceiver when in an area where blasting is in progress, or where "TURN OFF TWO-WAY RADIO" signs have been posted. If you are transporting blasting caps in your vehicle, make sure they are carried in a closed metal box with a padded interior. Do not transmit while the caps are being placed into or removed from the container.

## PRECAUTIONS

Observe the following precautions to prevent fire, personal injury, and transceiver damage.

- Do not attempt to configure the transceiver while driving; it is too dangerous.
- Do not disassemble or modify the transceiver for any reason.
- Do not expose the transceiver to long periods of direct sunlight, nor place it near heating appliances.
- Do not place the transceiver in excessively dusty, humid, or wet areas, nor on unstable surfaces.
- If an abnormal odor or smoke is detected coming from the transceiver, switch the transceiver power off immediately, and contact your **KENWOOD** dealer.
- Use of the transceiver while you are driving may be against traffic laws. Please check and observe the vehicle regulations in your area.
- Do not use options not specified by **KENWOOD**.

### **CAUTION**

- ◆ The transceiver operates in **12 V** negative ground systems only! Check the battery polarity and voltage of the vehicle before installing the transceiver.
- ◆ Use only the supplied DC power cable or a **KENWOOD** optional DC power cable.
- ◆ Do not insert metal objects into the cooling fan.

### **WARNING**

- ◆ Do not cut and/or remove the fuse holder on the DC power cable. Improper connections and/or current surges may cause smoke or fire.
- ◆ For passenger safety, install the transceiver securely using the supplied mounting bracket and screw set so the transceiver will not break loose in the event of a collision.

# CONTENTS

PREPARATION / INSTALLATION .....	1	SELECTING A MEMORY CALL USING A	
UNPACKING AND CHECKING EQUIPMENT .....	1	MICROPHONE KEYPAD .....	14
SUPPLIED ACCESSORIES .....	1	MANUAL STATUS CALLS .....	14
BASE STATION INSTALLATION .....	1	MAKING A STATUS CALL USING THE	
FOOT PADS .....	1	TRANSCIVER KEYS .....	14
ANTENNA CONNECTION .....	1	MAKING A STATUS CALL USING A	
GROUND CONNECTION .....	1	MICROPHONE KEYPAD .....	14
DC POWER SUPPLY CONNECTION .....	2	DIRECT STATUS CALLS .....	15
MOBILE INSTALLATION .....	2	OPTIONAL VOICE MESSAGES .....	15
INSTALLING THE TRANSCIVER .....	2	RECEIVING A STATUS CALL .....	15
ANTENNA CONNECTION .....	2	REVIEWING MESSAGES IN THE STACK MEMORY .....	15
GROUND CONNECTION .....	3	SEND THE GPS DATA .....	16
DC POWER CABLE CONNECTION .....	3	MANUALLY SENDING THE GPS DATA .....	16
GETTING ACQUAINTED .....	4	GPS POLLING .....	16
FRONT PANEL .....	4	SHORT TEXT MESSAGES .....	16
REAR PANEL .....	4	ADVANCED OPERATIONS .....	17
DISPLAY .....	5	DIRECT CHANNEL .....	17
MICROPHONE (OPTIONAL) .....	6	SCRAMBLER .....	17
PROGRAMMABLE FUNCTIONS .....	7	CHANGING THE SCRAMBLER CODE .....	17
BASIC OPERATIONS .....	8	VOX (VOICE-OPERATED TRANSMIT)	
SWITCHING POWER ON/OFF .....	8	SETUP .....	17
ADJUSTING THE VOLUME .....	8	VOX GAIN .....	17
SELECTING A CHANNEL .....	8	ANTI-VOX GAIN .....	17
DIRECT FREQUENCY ENTRY .....	8	VOX DELAY TIME .....	18
SELECTING A MODE .....	8	ANTENNA TUNER .....	18
DATA OPERATION .....	8	EMERGENCY .....	18
TRANSMITTING .....	9	CLARIFIER .....	18
VOX (VOICE-OPERATED TRANSMISSION) .....	9	NOISE BLANKER .....	19
CW KEYING .....	9	LCD BRIGHTNESS .....	19
CHANGING THE TRANSMIT POWER .....	9	POWER-ON TEXT .....	19
TIME-OUT TIMER .....	9	DISPAY NAME/ FREQUECY .....	19
OVERHEATING .....	9	PRE-AMPLIFIER/ ATTENUATOR .....	19
SQUELCH/ MONITOR .....	10	AUXILIARY .....	19
SQUELCH LEVEL .....	10	VGS-1 OPTIONAL VOICE GUIDE &	
CHANNEL MONITORING .....	10	STORAGE UNIT .....	20
MENU SETUP .....	11	VOICE MEMOS .....	20
ACCESSING THE MENU .....	11	RECORDING A VOICE MEMO .....	20
MENU CONFIGURATION .....	11	PLAYING BACK A VOICE MEMO .....	20
DELETING A VOICE MEMO .....	20	VOICE MESSAGES .....	20
RECORDING A VOICE MESSAGE .....	20	RECORDING A VOICE MESSAGE .....	20
PLAYING BACK A VOICE MESSAGE .....	21	PLAYING BACK A VOICE MESSAGE .....	21
TRANSMITTING A VOICE MESSAGE .....	21	TRANSMITTING A VOICE MESSAGE .....	21
DELETING A VOICE MESSAGE .....	21	AUTO RECORDING .....	21
PLAYING BACK AN AUTO RECORDING .....	21	PLAYING BACK AN AUTO RECORDING .....	21
DELETING AN AUTO RECORDING .....	21	VOICE GUIDE .....	21
VOICE GUIDE .....	21	APPENDIX .....	22
KEY FUNCTIONS .....	22	KEY FUNCTIONS .....	22
SELECTING A STATION USING THE TRANSCIVER KEYS ..	13		
SELECTING A STATION USING A MICROPHONE KEYPAD ...	13		
DIRECT SELCALLS .....	13		
RECEIVING A SELCALL .....	13		
MEMORY CALLS .....	13		
SELECTING A MEMORY CALL USING THE			
TRANSCIVER KEYS .....	13		

# PREPARATION / INSTALLATION

## UNPACKING AND CHECKING EQUIPMENT

**Note:** The following unpacking instructions are for use by your **KENWOOD** dealer, an authorized **KENWOOD** service facility, or the factory.

Carefully unpack the transceiver. We recommend that you identify the items listed in the following table before discarding the packing material. If any items are missing or have been damaged during shipment, file a claim with the carrier immediately.

## SUPPLIED ACCESSORIES

Item	Part Number	Quantity	
DC power cable (with fuses)	E30-3489-XX	1	
Fuse	25 A	F52-0044-XX	1
	4 A	F52-0038-XX	1
Foot pads	J02-1302-XX	2	
Instruction manual	B62-1866-XX	1	

## BASE STATION INSTALLATION

### FOOT PADS

A set of foot pads are provided so that you can protect the surface of your desk/table/shelf from scratching. Apply the foot pads to the base of the transceiver.

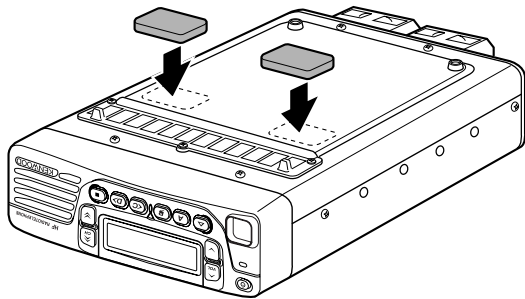

## ANTENNA CONNECTION

For best performance:

- Use a properly adjusted, good-quality 50  $\Omega$  antenna.
- Use a good-quality 50  $\Omega$  coaxial cable and connector.
- Match the impedance of the coaxial cable and antenna so that the SWR is 1.5:1 or less.
- Ensure that all connections are clean and tight.

The transceiver's protection circuit will activate if the SWR is greater than 2.5:1, but do not rely on protection to compensate for a poorly functioning antenna system. High SWR will cause the transmit output to drop, and may lead to radio frequency interference with consumer products such as stereo receivers and televisions. You may even interfere with your own transceiver. Reports that your signal is garbled or distorted, especially at peak modulation, may indicate that your antenna system is not transmitting efficiently.



- CAUTION**
- ◆ Transmitting without first connecting an antenna or other matched load may damage the transceiver. Always connect the antenna to the transceiver before transmitting.
  - ◆ Use a lightning arrester to prevent fire, electric shock, or damage to the transceiver.

## GROUND CONNECTION

- A good DC ground is required to prevent such dangers as electric shock.
- A good RF ground is required for superior communications, against which the antenna system can operate.

Both of these conditions can be met by providing a good earth ground for your station. Bury one or more ground rods or a large copper plate under the ground, and connect this to the transceiver GND terminal. Use heavy gauge wire or a copper strap, cut as short as possible, for the connection. Ensure that all connections are clean and tight.

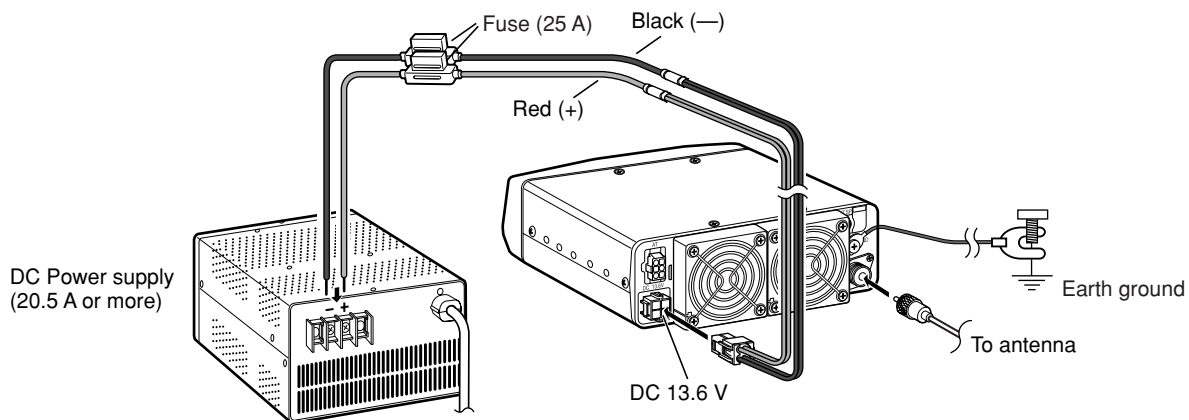

Base Station Installation

## DC POWER SUPPLY CONNECTION

In order to use this transceiver as a base station, you will need a separate 13.6 V DC power supply with a current capacity of 20.5 A or higher (purchased separately).



CAUTION

- ◆ Do not directly connect the transceiver to an AC outlet.
- ◆ Do not substitute the supplied DC power cable with a cable with smaller gauge wires.
- ◆ Before connecting the DC power supply to the transceiver, be sure to switch the DC power supply OFF.
- ◆ Do not plug the DC power supply into an AC outlet until you make all connections.

- 1 Connect the supplied DC power cable to the regulated DC power supply and check that the polarities are correct (Red: positive, Black: negative).
- 2 Connect the connectorized end of the DC power cable to the DC 13.6 V powerconnector on the rear of the transceiver.
  - Press the DC power cable connector firmly into the connector on the radiotelephone until the locking tab clicks.

### REPLACING FUSES

If the fuse blows, determine the cause then correct the problem. After the problem is resolved, only then replace the fuse. If newly installed fuses continue to blow, disconnect the power plug and contact your dealer for assistance.

Following are the ratings for fuses used with this transceiver:

Transceiver: 4 A (for KAT-1 antenna tuner)

DC cable: 25 A



CAUTION

- ◆ When replacing any fuse, be sure to replace it with a fuse of the same value. Never replace a fuse with a fuse that has a higher value.
- ◆ Replace blown fuses only after investigating and correcting the cause of the failed fuse.

## MOBILE INSTALLATION



WARNING

Various electronic equipment in your vehicle may malfunction if they are not properly protected from the radio frequency energy which is present while transmitting. Electronic fuel injection, anti-skid braking, and cruise control systems are typical examples of equipment that may malfunction. If your vehicle contains such equipment, consult the dealer for the make of vehicle and enlist his/her aid in determining if they will perform normally while transmitting.

**Note:** The following preparation instructions are for use by your **KENWOOD** dealer, an authorized **KENWOOD** service facility, or the factory.

## INSTALLING THE TRANSCEIVER



WARNING

For passenger safety, install the transceiver securely using an optional mounting bracket so the transceiver will not break loose in the event of a collision.

- 1 Mark the position of the holes in the dash by using the mounting bracket as a template. Drill the holes, then attach the mounting bracket using self-tapping screws supplied with the bracket.
  - Be sure to mount the transceiver in a location where the controls are within easy reach of the user and where there is sufficient space at the rear of the transceiver for cable connections.
- 2 Connect the antenna and the supplied power cable to the transceiver {page 3}.
- 3 Slide the transceiver into the mounting bracket and secure it.
- 4 Mount the microphone hanger in a location where it will be within easy reach of the user.
  - The microphone and microphone cable should be mounted in a place where they will not interfere with the safe operation of the vehicle.

## ANTENNA CONNECTION

For best performance:

- Use a properly adjusted, good-quality 50  $\Omega$  antenna.
- Use a good-quality 50  $\Omega$  coaxial cable and connector.

Coupling the antenna to the transceiver via feed lines having an impedance other than 50  $\Omega$  reduces the efficiency of the antenna system and can cause interference to nearby broadcast television receivers, radio receivers, and other electronic equipment.



CAUTION

Transmitting without first connecting an antenna or other matched load may damage the transceiver. Always connect the antenna to the transceiver before transmitting.

## GROUND CONNECTION

- A high-quality ground installation significantly improves the performance of a mobile antenna.

Securely connect a low-resistance ground strap (or large gauge copper wire if unavailable) from the transceiver GND terminal to the vehicle chassis. Clean paint or dirt from the vehicle connection point to expose bare metal before connecting the ground.

## DC POWER CABLE CONNECTION



CAUTION

The transceiver operates in 12 V negative ground systems only! Check the battery polarity and voltage of the vehicle before installing the transceiver.

- 1 Check for an existing hole, conveniently located in the firewall, where the power cable can be passed through. If no hole exists, use a circle cutter to drill the firewall, then install a rubber grommet.
- 2 Run the two power cable leads through the firewall and into the engine compartment, from the passenger compartment.
- 3 Connect the red lead to the positive (+) battery terminal and the black lead to the negative (-) battery terminal.
  - Use the full length of the cable without cutting off any excess; in particular, never remove the fuse holders.
  - To prevent the risk of short circuits, disconnect other wiring from the negative (-) battery terminal before connecting the transceiver. Reconnect the wiring after connecting the transceiver to the battery.
  - Locate the fuse as close to the battery as possible.
- 4 Coil and secure the surplus cable with a retaining band.
  - Be sure to leave enough slack in the cables so the transceiver can be removed for servicing while keeping the power applied.
  - Ensure that the cable is isolated from heat and moisture. If necessary, wrap heat-resistant tape around the fuse holder to protect it from moisture.
  - If using a noise filter, it should be installed with an insulator to prevent it from touching metal on the vehicle.

- 5 Connect the DC power cable to the rear of the transceiver.
  - Press the connectors firmly together until the locking tab clicks.

### Note:

- ◆ We do not recommend using the cigarette lighter socket, as some cigarette lighter sockets introduce an unacceptable voltage drop.
- ◆ If you use the transceiver for a long period when the vehicle battery is not fully charged or when the engine is OFF, the battery may become discharged and will not have sufficient reserves to start the vehicle. Avoid using the transceiver under these conditions.

## REPLACING FUSES

If the fuse blows, determine the cause then correct the problem. After the problem is resolved, only then replace the fuse. If newly installed fuses continue to blow, disconnect the power plug and contact your dealer for assistance.

Following are the ratings for fuses used with this transceiver:

Transceiver: 4 A (for KAT-1 antenna tuner)

DC cable: 25 A



CAUTION

- ◆ When replacing any fuse, be sure to replace it with a fuse of the same value. Never replace a fuse with a fuse that has a higher value.
- ◆ Replace blown fuses only after investigating and correcting the cause of the failed fuse.

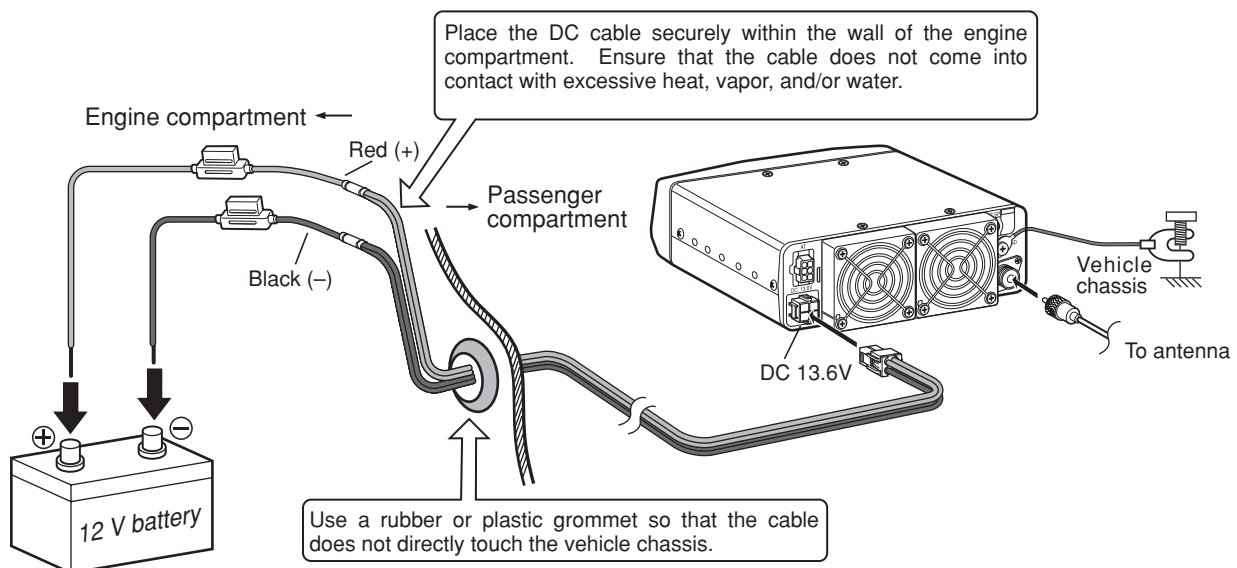

Mobile Installation



# GETTING ACQUAINTED

## FRONT PANEL

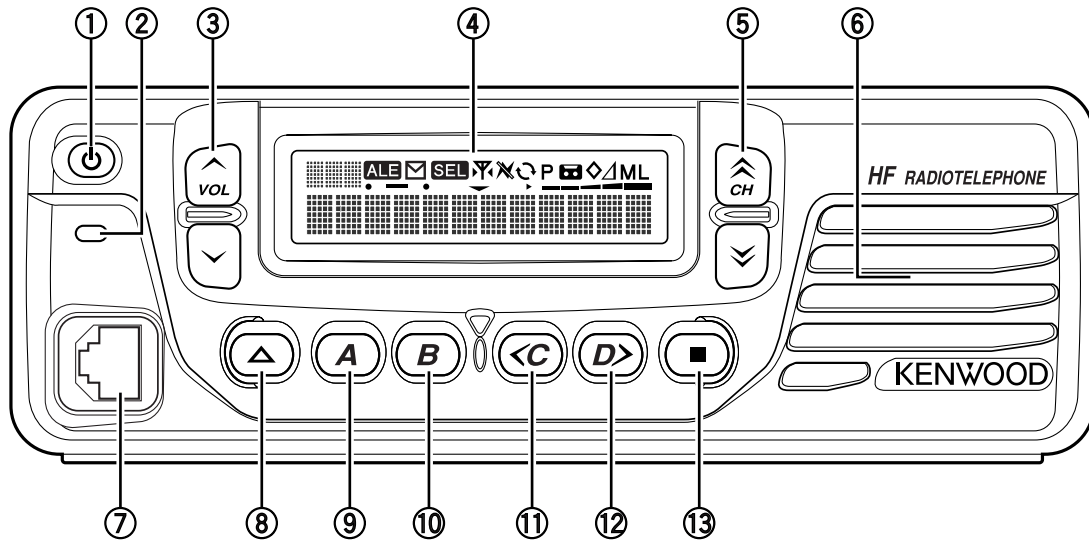

- ① **⏻ (Power) switch**  
Press to switch the transceiver power ON. Press again to switch the power OFF.
- ② **Transmit/ Busy/ Call indicator**  
Lights red while transmitting and green while receiving a signal. Flashes orange during selcall.
- ③ **VOL ^ / v keys**  
Press the ^ key to increase the volume and the v key to decrease the volume.
- ④ **Display**  
Refer to page 5.
- ⑤ **CH ^ / v keys**  
Press the ^ key to increase the channel number and the v key to decrease the channel number.
- ⑥ **Internal Speaker**  
Audio is heard from this speaker if no external speaker is connected.
- ⑦ **Microphone jack**  
Connect an optional microphone to this jack.
- ⑧ **△ key**  
Press to activate its programmable function {page 7}. The default setting is **Antenna Tuner**.
- ⑨ **A key**  
Press to activate its programmable function {page 7}. The default setting is **Squelch Level**.
- ⑩ **B key**  
Press to activate its programmable function {page 7}. The default setting is **Scan**.
- ⑪ **<C key**  
Press to activate its programmable function {page 7}. The default setting is **Clarifier**.
- ⑫ **D> key**  
Press to activate its programmable function {page 7}. The default setting is **Mode**.
- ⑬ **■ key**  
Press to activate its programmable function {page 7}. The default setting is **Menu**.

## REAR PANEL

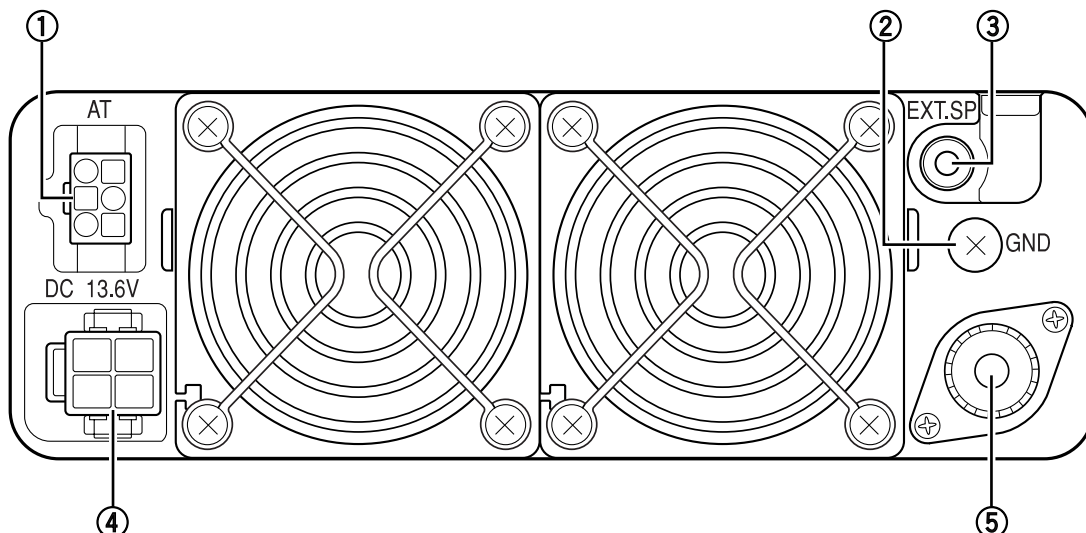



- ① **AT connector**  
Attach an optional KAT-1 external Antenna Tuner here.
- ② **GND terminal**  
Connect a heavy gauge wire or copper strap between this ground terminal and the nearest earth ground.
- ③ **EXT SP jack**  
Connect an external 4 ~ 8 Ω speaker to this jack. Mates with a 3.5 mm (1/8") diameter, 2-conductor (mono) plug. Connecting an external speaker automatically cuts off the audio from the internal speaker.
- ④ **DC 13.6 V power input connector**  
Connect a 13.6 V DC power source to this connector. Use the supplied cable with a regulated DC power supply.
- ⑤ **Antenna connector**  
Connect the feed line from your 50 Ω antenna to this connector. Mates with a PL-259 male connector.

## DISPLAY



Indicator	Description
	Displays the channel names and frequencies. Your dealer can program channel names with up to 12 characters, in place of frequencies. Also displays received status messages.
	Displays the channel numbers. Also displays the menu number while in Menu mode.
<b>ALE</b>	Appears when the optional ALE function is activated.
	Flashes when you receive a message. Lights when a message is stored in the stack memory {page 15}.
<b>SEL</b>	Appears when Selcall has been activated {page 13}.
	Flashes while the optional antenna tuner is tuning. Lights when a good match is obtained with the antenna system {page 18}.
	Appears when the Noise Blanker function is activated {page 19}.
	Appears when you are using Scan mode {page 12}.
<b>P</b>	Appears when the selected channel is programmed as Preferred {page 12}.
	Appears when a recording has been stored in your transceiver memory. This icon is only used with the optional VGS-1 {page 21}.
	Appears when the Scrambler function is activated {page 17}.
	Appears when the Clarifier function is activated {page 18}.
<b>M</b>	Appears when transmitting using medium power {page 9}.
<b>ML</b>	Appears when transmitting using medium-low power {page 9}.
<b>L</b>	Appears when transmitting using low power {page 9}.
	Appears when the AUX function has been activated {page 19}.
	Appears when the VOX function has been activated {page 17}.
	This icon is not used on this transceiver.
	Appears when the selected channel is added to the scanning sequence {page 12}.
	Appears when the Pre-amplifier function has been activated {page 19}.
	While receiving, displays the received signal strength. While transmitting, serves as a relative transmit RF meter. While acting as an RF meter, a full-scale indication corresponds to the programmed maximum power.

## MICROPHONE (OPTIONAL)

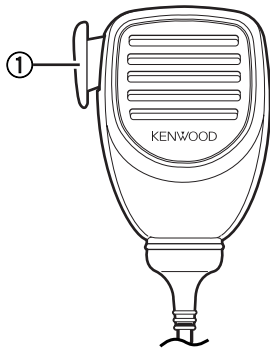

Optional KMC-30 Microphone

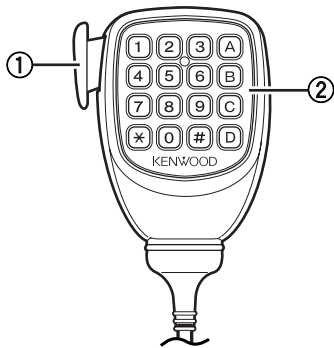

Optional KMC-32 Microphone

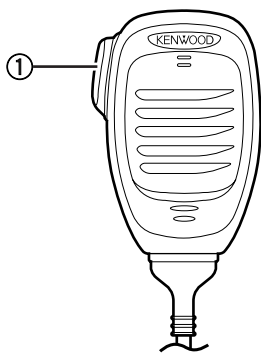

Optional KMC-35 Microphone

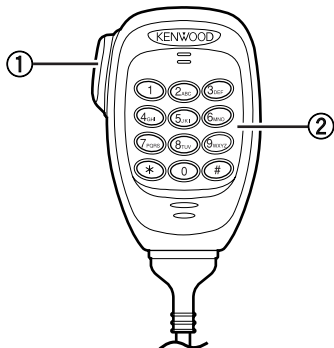

Optional KMC-36 Microphone

### ① PTT (Push-to-Talk) switch

Press and hold this switch, then speak into the microphone to make a call.

### ② Keypad

Press these keys to enter a frequency {page 8}. Press the \* key to cancel the frequency entry and the # key to complete the frequency entry.

Press the **A**, **B**, **C**, **D**, **#**, and \* keys to activate their programmable functions {page 7}.

In Selcall Mode, press these keys to enter a Selcall/Status ID {page 13}. Press the \* key to unmute the speaker in Selcall mode and the # key to reset the entered Selcall ID. Use the **A**, **B**, **C**, and **D** keys to access memory codes.

## PROGRAMMABLE FUNCTIONS

---

The **△**, **S**, **A**, **<B**, **C>**, **■**, and optional microphone **A**, **B**, **C**, and **D** keys can be programmed with the functions listed below. The microphone **#** and **\*** keys can be programmed only with the Channel Up/Down and Volume Up/Down functions. Please contact your dealer for further details on these functions.

- Antenna Tuner
- Anti-VOX Gain
- Auto Recording <sup>1</sup>
- AUX
- Call Type
- Channel Down
- Channel Up
- Clarifier
- Direct Call 1 ~ 4
- Direct CH 1 ~ 4
- Direct Status Call 1 ~ 4
- Display Character
- Emergency <sup>2</sup>
- LCD Brightness
- Menu
- Mode
- Monitor
- Noise Blanker
- None
- Playback 1 ~ 4 <sup>1</sup>
- Pre-amplifier/ Attenuator
- Scan
- Scan Delete/Add
- Scrambler
- Selcall
- Squelch Level
- Transmit Power
- VFO
- Volume Down
- Volume Up
- VOX
- VOX Delay
- VOX Gain

<sup>1</sup> "Auto Recording" and "Playback 1 ~ 4" can be programmed only when the optional VGS-1 board has been installed.

<sup>2</sup> "Emergency" can be programmed only on the **△** key.

# BASIC OPERATIONS

## SWITCHING POWER ON/ OFF

Press and hold the **⏻** switch to switch the transceiver ON.

- A beep sounds and the power-on message momentarily appears.



Press and hold the **⏻** switch again to switch the transceiver OFF.

## ADJUSTING THE VOLUME

Press the **VOL ^** key to increase the volume and the **VOL v** key to decrease the volume.

- Additionally, you can press and hold the **VOL ^ / v** keys to continuously change the volume level, rather than adjusting it by only 1 step at a time.



## SELECTING A CHANNEL

Press the **CH ^** key to increase the channel number and the **CH v** key to decrease the channel number.

- Additionally, you can press and hold the **CH ^ / v** keys to continuously change the channel number, rather than changing it by only 1 step at a time.



## DIRECT FREQUENCY ENTRY

Besides using the **CH ^ / v** keys to select your pre-programmed memory channels, you can directly enter a VFO station frequency using an optional microphone keypad.

- 1 Press and hold the key programmed as **VFO** for approximately 1 second.
  - The frequency of the currently selected channel appears on the display along with the selected operating mode.

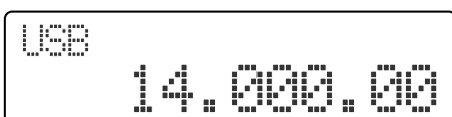

- 2 Enter your desired frequency using a microphone keypad (0 ~ 9).
  - Direct entry only allows you to enter down to the 10's value; 0 is automatically selected for the 1's value.



- 3 After entering a frequency using the microphone keypad, press the **#** key.
  - To cancel the frequency entry, press the **\*** key; the frequency will return to the original frequency before you started to enter your new frequency.
- 4 To exit VFO mode and return to your preprogrammed memory channels, press and hold the **VFO** key again.

### ■ VFO STEP VALUE

When using the **CH ^ / v** keys to select a frequency in VFO mode, the frequency is adjusted by a pre-determined step value. You can adjust this step value as follows:

- 1 Press the key programmed as **VFO**.
- 2 Press the **<C and D>** keys to select the desired digit (10's, 100's, 1000's, etc.).
- 3 Press the **CH ^ / v** keys to select the desired value for the digit you selected in the previous step.
  - The default step value is 10 Hz.
- 4 Press the **Δ** key to store the new step value and exit the VFO step value adjustment.

## SELECTING A MODE

The mode stored with each channel can be temporarily changed. To change the operating mode:

- 1 Press the key programmed as **Mode**.
- 2 Continuously press the **Mode** key to cycle through the various available operation modes as displayed below:

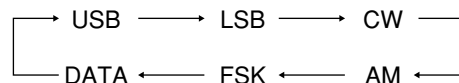

- 3 After selecting your desired mode, perform no operations for 1 second to return to save the operation mode and exit.

## DATA OPERATION

Your dealer can program various settings for FSK and DATA modes. Ask your dealer for details.

## TRANSMITTING

**Note:** You cannot transmit on channels that have only a receive frequency stored.

- 1 Select the desired channel or frequency.
- 2 Press microphone **PTT** switch and speak into the microphone. Release the **PTT** switch to receive.
  - For best sound quality at the receiving station, hold the microphone approximately 3 ~ 4 cm (1.5 inches) from your mouth.

## VOX (VOICE-OPERATED TRANSMISSION)

VOX eliminates the need of manually switching to transmit mode each time you want to make a call. The transceiver automatically switches to transmit when the VOX feature senses that you have begun speaking into the microphone.

- When VOX is activated, the VOX icon (  ) appears on the display.

To properly use the VOX feature, you must properly set up the VOX Gain, VOX Anti-Gain, and VOX Delay Time for your environment {page 17}.

## CW KEYING

- 1 Select a CW channel.
- 2 With a CW key connected to the transceiver, begin transmitting by keying.
  - In order to use CW keying, your dealer must have enabled the CW break-in function on your transceiver. The default setting for CW break-in is disabled.
  - When CW break-in is enabled, pressing the **PTT** switch will not allow transmission. When CW break-in is disabled, pressing the **PTT** switch will allow transmission.
- 3 To end the transmission, stop keying.
  - After keying has stopped, the transceiver will remain in transmit mode momentarily before returning to receive mode.

## CHANGING THE TRANSMIT POWER

If your call is too weak (or is using unnecessarily high power), you can adjust the transmit power for your channel/frequency.

- 1 Press the key programmed as **Transmit Power**.



- 2 Continuously press the **Transmit Power** key to cycle through the various power settings as displayed below:

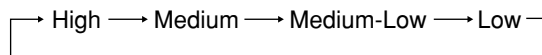

- Your dealer may have set a power limit on some channels. In this case, the settings available may be limited. Additionally, if a channel is set up as receive-only, you will be unable to set a transmit power for that channel.
- When using Low power, "L" appears on the display. When using Medium-Low power, "ML" appears on the display. When using Medium power, "M" appears on the display. When using High power, no icon appears on the display.

## TIME-OUT TIMER

If you continuously transmit for a period of time that exceeds the programmed time set by your dealer (default is OFF), the transceiver will stop transmitting and an alert tone will sound. To stop the tone, return the transceiver to receive mode.

Your dealer can program the TOT time in the range of 3 to 30 minutes.

## OVERHEATING

The internal fan operates automatically to keep the transceiver cool, especially during extended transmissions and extended operation using high power. However, if the temperature rises too high, an internal protection circuit will activate, reducing the transceiver power.

- "HIGH-TEMP" appears on the display.



**Note:** When "HIGH-TEMP" appears on the display, ensure that the transceiver cooling fan is functioning.

## SQUELCH/ MONITOR

---

The purpose of squelch is to silence audio output from the speaker when no signals are present. Setting the squelch threshold too high causes the squelch to remain closed while a weak signal is present. Setting the threshold too low allows noise to be heard between transmissions from other stations.

### SQUELCH LEVEL

Adjust the squelch level to just eliminate the background noise when no signal is present. If signals are weak, set the control to a lower threshold:

- 1 Press the key programmed as **Squelch Level**.



- 2 Press the **<C** key to decrease the squelch level (open) and the **D>** key to increase the squelch level (tighten).
- 3 Press the **△** key to store the new squelch level and exit the squelch level adjustment.

### CHANNEL MONITORING

You can use the key programmed as **Monitor** to listen to weak signals that you cannot hear during normal operation and to adjust the volume when no signals are present on your selected channel.

Press and hold the **Monitor** key to turn the transceiver squelch off.

Release the **Monitor** key to return to normal operation.

# MENU SETUP

Many functions of this transceiver are selected or configured via a software-controlled Menu rather than using physical controls on the transceiver. Once familiar with the Menu system, you will appreciate the versatility it offers.

## ACCESSING THE MENU

The following procedure explains how to check or change any of the Menu items:

- 1 Press the key programmed as **Menu**.
  - Alternatively, you can press any key that has been pre-programmed with direct access to a particular menu. For example, to access Menu No. 1, you could press the key programmed as **Squelch Level**.



- 2 Press the **CH**  $\wedge$  /  $\vee$  keys to select the desired Menu number.
  - **CH**  $\wedge$  increments the Menu number and **CH**  $\vee$  decrements the Menu number.



- 3 Press the **<C** and **D>** keys to select a parameter.
  - Alternatively, you can press the KMC-32 microphone **C** and **D** keys.
- 4 Press the **Δ** key to save your selection and exit Menu mode.
  - Alternatively, you can press the microphone **\*** key.

## MENU CONFIGURATION

Menu No.	Menu Name	Full Function Name
1	SQL LVL	Squelch Level adjustment
2	CLARI	Clarifier
3	NB	Noise Blanker
4	BRIGHT	LCD Brightness
5	DISP	Display: channel name or frequency
6	VOX	VOX ON/OFF
7	VOX DLY	VOX Delay Time
8	VOX GAIN	VOX Gain
9	ANTI VOX	Anti-VOX Gain
10	CALL TYP	Call Type

Following is a list of "Direct Access" keys that can be programmed for each of the Menus.

Menu No.	Menu Name	Direct Access Key
1	SQL LVL	Squelch Level
2	CLARI	Clarifier
3	NB	Noise Blanker
4	BRIGHT	LCD Brightness
5	DISP	Display
6	VOX	VOX
7	VOX DLY	VOX Delay
8	VOX GAIN	VOX Gain
9	ANTI VOX	Anti-VOX Gain
10	CALL TYP	Call Type



# SCAN

Scan allows each of the channels that has a receive frequency stored to be automatically monitored for activity. Channels must be added to the scanning sequence in order to be scanned.

To activate Scan, press the key programmed as **Scan**.

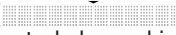
- The  icon appears on the display.
- The channel add indicator (  ) will appear on the display when the selected channel is added to the scan sequence.
- If only one channel is added to the scan sequence or has a frequency stored, pressing the **Scan** key causes an error tone to sound and Scan does not operate.

To stop scanning, press the **Scan** key again.

## BUSY FREQUENCY STOP

The transceiver will automatically pause on a channel when a signal is detected. The transceiver will remain on the busy channel for either a short time or until the signal drops out, depending on which Scan Resume type your dealer has set up (see below).

- The squelch must be adjusted to the noise threshold point with no signals present for Busy Frequency Stop to operate.

When the transceiver has paused on a channel, you can transmit by pressing the microphone **PTT** switch. Depending on your dealer settings, Scan may either end when you transmit or continue to operate. If Scan is set to continue even after transmitting, then it will remain on the current channel for a predetermined time before continuing. This time is set so that if a signal re-appears on the channel, or if you transmit again, Scan will remain on the current channel until the signal either drops out or you stop transmitting.

## SCAN RESUME TYPE

Scan Resume controls when the transceiver continues scanning after stopping due on a busy channel.

- **Time-Operated Scan:** After stopping on a busy channel, Scan resumes after a predetermined time (set by your dealer) whether or not the signal is still present on the channel.
- **Carrier-Operated Scan:** The transceiver remains on the busy channel until the signal ends. Scan resumes after a predetermined time (set by your dealer) after the signal has dropped out.

## PREFERRED SCAN

A Preferred channel must be programmed in order for Preferred Scan to function.

During Scan, the Preferred channel is checked during regular intervals (set up by your dealer). This interval ensures that you do not miss important transmissions on your Preferred channel, while scanning other channels.

- The **P** indicator appears on the display when the Preferred channel is selected.

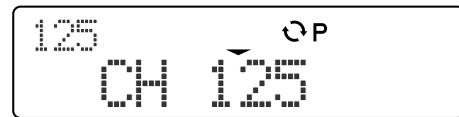

## ADD TO SCAN/ REMOVE FROM SCAN

Press the key programmed as **Scan Delete/Add**, to add or remove each channel to or from the scan sequence. Only those channels that have been added to the scan sequence will be scanned. Deleted channels will be skipped.

- The channel add indicator (  ) will appear on the display when the selected channel is added to the scan sequence.



## SCAN REVERT CHANNEL

Your dealer can set up 1 of 4 different types of Scan Reverts for your transceiver. A Scan Revert channel is the channel that you are able to transmit on during Scan, when you press the microphone PTT switch.

- **Preferred Channel:** If your dealer has programmed a Preferred channel, this channel is the revert channel.
- **Preferred Channel + Talkback:** If your dealer has programmed a Preferred channel, this channel is the revert channel. However, when paused on a busy channel, you are able to “talk back” on that channel until Scan resumes.
- **Selected Channel:** The last channel selected before you began scanning is assigned as the revert channel.
- **Selected Channel + Talkback:** The last channel selected before you began scanning is assigned as the revert channel. However, when paused on a busy channel, you are able to “talk back” on that channel until Scan resumes.

# SELECTIVE CALLS

A Selective Call, or Selcall, is a voice call to a particular station or group of stations.

## ACTIVATING SELCALL MODE

To activate Selcall Mode, access Menu No. 10 (Call Type) {page 11} and set the call type to Selcall.

## MANUAL SELCALLS

If your dealer has programmed your transceiver with a list of stations, you can manually select a station to send a selcall.

### SELECTING A STATION USING THE TRANSCEIVER KEYS

- 1 While in Selcall Mode, press the key programmed as **Selcall** to view the Selcall list.



- 2 Press the **CH**  $\wedge$  and  $\vee$  keys to select the ID of the station you want to call.
- 3 Press the **PTT** switch and begin your conversation.
  - Alternatively, you can press the  $\blacksquare$  key to page the selected station, rather than making a voice call.
  - While making the call, the **SEL** icon flashes.
- 4 When the call connects, the LED indicator flashes orange. Begin your conversation by pressing the **PTT** switch and speaking into the microphone.
- 5 After you have finished your call, release the **PTT** switch.
  - A proceed tone sounds and the **SEL** icon remains on the display.
  - Depending on the Auto Reset time set up by your dealer, your speaker will mute if no response is received. You can unmute the speaker to remain in standby mode by pressing the key programmed as **Monitor**.

### SELECTING A STATION USING A MICROPHONE KEYPAD

- 1 While in Selcall Mode, press and hold the **PTT** switch, then enter the 3-digit ID of the station you want to call, followed by the # key.
  - Releasing the **PTT** switch before entering the # key will cancel the call.
  - The \* key is used as a wild card when entering group codes. For example, sending the group code \*00 allows you to contact all stations that have "00" as the last 2 digits of their ID codes.
  - While making the call, the **SEL** icon flashes.
- 2 When the call connects, the LED indicator flashes orange. Begin your conversation by pressing the **PTT** switch and speaking into the microphone.

- 3 After you have finished your call, release the **PTT** switch.
  - A proceed tone sounds and the **SEL** icon remains on the display.
  - Depending on the Auto Reset time set up by your dealer, your speaker will mute if no response is received. You can unmute the speaker to remain in standby mode by pressing the # key or the key programmed as **Monitor**.

## DIRECT SELCALLS

Your dealer can program up to 4 special keys so that you can quickly and easily make a selcall to a specific station.

Press the key programmed as **Direct Call 1** to **Direct Call 4** to send a selcall to the stations programmed onto those keys.

- While making the call, the **SEL** icon flashes. When the call is complete, the **SEL** icon remains on the display.
- Depending on the Auto Reset time set up by your dealer, your speaker will mute if no response is received. You can unmute the speaker to remain in standby mode by pressing the # key or the key programmed as **Monitor**.

## RECEIVING A SELCALL

When a Selcall is received, an alert tone will sound and the calling station's ID (or name) will appear on the display.

To respond to the call, press the **PTT** switch and speak into the microphone.

- Depending on the Auto Reset time set up by your dealer, your speaker will mute if no response is received. You can unmute the speaker to remain in standby mode by pressing the # key or the key programmed as **Monitor**.

## MEMORY CALLS

If a character message has been set up in one of the 4 available memory call locations, you can easily send those messages when making a Selcall.

### SELECTING A MEMORY CALL USING THE TRANSCEIVER KEYS

- 1 While in Selcall Mode, press the key programmed as **Selcall** to view the Selcall list.



- 2 Press the **CH**  $\wedge$  and  $\vee$  keys to select CODE A to CODE D.
  - Press the **D>** key to view the character message of the selected code, and the **<C** key to return to the code selection.



- 3 Press the **■** key or the **PTT** switch to send the message.
  - While making the call, the **SEL** icon flashes.
- 4 When the call connects, the LED indicator flashes orange. Begin your conversation by pressing the **PTT** switch and speaking into the microphone.
  - A proceed tone sounds and the **SEL** icon remains on the display.
- 5 After you have finished your call, release the **PTT** switch.
  - Depending on the Auto Reset time set up by your dealer, your speaker will mute if no response is received. You can unmute the speaker to remain in standby mode by pressing the key programmed as **Monitor**.

### SELECTING A MEMORY CALL USING A MICROPHONE KEYPAD

- 1 While in Selcall Mode, press and hold the **PTT** switch, then enter the **#** key, key **A** to **D** (to select the respective memory location), followed by the **#** key again.
  - Releasing the **PTT** switch before entering the final **#** key will cancel the call.
  - While making the call, the **SEL** icon flashes.
- 2 When the call connects, the LED indicator flashes orange. Begin your conversation by pressing the **PTT** switch and speaking into the microphone.
  - A proceed tone sounds and the **SEL** icon remains on the display.
- 3 After you have finished your call, release the **PTT** switch.
  - Depending on the Auto Reset time set up by your dealer, your speaker will mute if no response is received. You can unmute the speaker to remain in standby mode by pressing the **#** key or the key programmed as **Monitor**.

## MANUAL STATUS CALLS

You can send and receive 2-digit Status codes which may be decided in your talk group. Codes can contain up to 12 alphanumeric character messages. Status codes range from 10 to 99 (80 ~ 99 are reserved for special messages).

### MAKING A STATUS CALL USING THE TRANSCEIVER KEYS

- 1 While in Selcall Mode, press the key programmed as **Selcall** to view the Selcall list.



- 2 Press the **CH**  $\wedge$  and  $\vee$  keys to select the ID of the station you want to call.
- 3 Press the **D>** key to view the Status list.



- 4 Press the **CH**  $\wedge$  and  $\vee$  keys to select the status you want to transmit.
- 5 Press the **■** key or the **PTT** switch to send the status call.
  - While making the call, the **SEL** icon flashes and "SEND DATA" appears on the display.
  - "COMPLETE" appears on the display when the call has been successfully transmitted.



- If the call cannot go through, "NO REPLY" appears on the display.

### MAKING A STATUS CALL USING A MICROPHONE KEYPAD

- 1 While in Selcall Mode, press and hold the **PTT** switch, then enter the 3-digit ID of the station you want to call.
- 2 While continuing to hold the **PTT** switch, press the **\*** key to enter Status entry mode.
- 3 While continuing to hold the **PTT** switch, enter the 2-digit ID number of the status you want to transmit.
- 4 While continuing to hold the **PTT** switch, press the **#** key to send the status call.
  - Releasing the **PTT** switch before entering the **#** key will cancel the call.
  - While making the call, the **SEL** icon flashes and "SEND DATA" appears on the display.
  - "COMPLETE" appears on the display when the call has been successfully transmitted.
  - If the call cannot go through, "NO REPLY" appears on the display.

## DIRECT STATUS CALLS

Your dealer can program up to 4 special keys so that you can quickly and easily make a status call to a specific station.

Press the key programmed as **Direct Status Call 1** to **Direct Status Call 4** to send the programmed status call to the stations programmed onto those keys.

- While making the call, the **SEL** icon flashes and "SEND DATA" appears on the display. When the call is complete, the **SEL** icon remains on the display.
- "COMPLETE" appears on the display when the call has been successfully transmitted.
  - If the call cannot go through, "NO REPLY" appears on the display.

## OPTIONAL VOICE MESSAGES

If both you and the target transceiver have optional VGS-1 units installed on your transceivers {page 20}, you can also use voice recordings as status messages.

- 1 While in Selcall Mode, press the key programmed as **Selcall** to view the Selcall list.



- 2 Press the **CH**  $\wedge$  and  $\vee$  keys to select the ID of the station you want to call.
- 3 Press the **D>** key to view the Status list.



- 4 Press the **CH**  $\wedge$  and  $\vee$  keys to select "VOICE REC".



- 5 Press the **■** key or the **PTT** switch to initiate the call.
  - While making the call, the **SEL** icon flashes.
  - A timer appears on the display when the transceiver is ready to receive your recording.
- 6 Press the **PTT** switch and speak into the microphone to begin your recorded message.
  - As you make your recording, the timer will count down.
- 7 Press the  $\Delta$  key to end the recording at any time before the timer expires.

## RECEIVING A STATUS CALL

A maximum of 5 received messages can be stored in the stack memory of your transceiver. These saved messages can be reviewed after reception. When the stack memory is full, either the oldest message will be erased when a new message is received or the new message will not be stored in the stack memory.

- 1 The  $\boxtimes$  icon will flash and a calling ID will appear when a status call is received.



- 2 Press the **D>** key to view the status call.



- 3 Press the  $\Delta$  key to return to normal operation.
  - The  $\boxtimes$  icon remains on the display when a message is stored in the stack memory.

## REVIEWING MESSAGES IN THE STACK MEMORY

- 1 Press and hold the key programmed as **Selcall** for 1 second to enter Status Confirmation mode.
  - The name or ID of the person who sent the last received message is displayed with the message number.



- The  $\boxtimes$  icon will flash when there is a message stored in memory that has not yet been viewed.
  - The  $\boxtimes$  icon will flash when there is a voice message stored in memory.
- 2 Press the **CH**  $\wedge$  and  $\vee$  keys to select the desired caller ID.



- 3 Press the **D>** key to view the message and the **<C** key to return to the caller ID list.
  - When selecting a voice message, "VOICE MSG" appears on the display and the message will be played back.
- 4 Press the  $\Delta$  key to return to normal operation.
  - To delete the selected message, press the **A** key. To confirm the deletion, press the **■** key. To cancel, press the  $\Delta$  key.
  - To delete all messages, press and hold the **A** key for 1 second. To confirm the deletion, press the **■** key. To cancel, press the  $\Delta$  key.

## SEND THE GPS DATA

If a GPS unit has been installed and is set up by your dealer, your transceiver may automatically transmit your GPS data.

### MANUALLY SENDING THE GPS DATA

- 1 While in Selcall Mode, press the key programmed as **Selcall** to view the Selcall list.



- 2 Press the **CH**  $\wedge$  and  $\vee$  keys to select the ID of the station you want to call.
- 3 Press the **D>** key to view the Status list.



- 4 Press the **CH**  $\wedge$  and  $\vee$  keys to select "GPS DATA".



- 5 Press the  $\blacksquare$  key or the **PTT** switch to send the GPS data.
  - While making the call, the **SEL** icon flashes and "SEND DATA" appears on the display.
  - "COMPLETE" appears on the display when the call has been successfully transmitted.



### GPS POLLING

If your transceiver receives a GPS Polling request, it will automatically transmit your GPS data to the requesting station.

- "SEND DATA" appears on the display until the data has been transmitted.



### SHORT TEXT MESSAGES

To send and receive short text messages, you must connect the transceiver to a PC. Ask your dealer for details.

- Short text messages can contain a maximum of 48 characters.

# ADVANCED OPERATIONS

## DIRECT CHANNEL

Your dealer can program up to 4 keys to allow you to quickly and easily jump to a frequently used channel. Press the keys programmed as **Direct CH 1** to **Direct CH 4** to select the memory channels they have been programmed to access.

## SCRAMBLER

If your dealer has installed an optional scrambler board, you can make private calls to others. Although the scrambler function does not offer complete privacy with your calls, it does prevent others from easily listening in on your calls. When activated, the transceiver distorts your voice so that anybody listening to your conversation will be unable to clearly hear what you are saying.

In order for members of your own group to clearly hear your call while you are using the scrambler, all other members must have the same scrambler code set up on their transceivers. This distorts everybody's voice while transmitting and corrects the voice message on your own transceiver when you receive the call.

To activate the scrambler, press the key programmed as **Scrambler**.

- The  icon appears on the display while the scrambler is active.



To deactivate the scrambler, press the **Scrambler** key again.

## CHANGING THE SCRAMBLER CODE

It is possible to change the pre-set scrambler code on a channel:

- 1 Press and hold the key programmed as **Scrambler** for approximately 1 second.



- 2 Press the **<C or D>** key to select a new code (from 1 to 16).
- 3 Press the **△** key to store the new code and exit.

**Note:** If the scrambler memory is not enabled by your dealer, changing the channel or turning the transceiver power OFF will reset your scrambler code to the default setting.

## VOX (VOICE-OPERATED TRANSMIT) SETUP

VOX eliminates the need of manually switching to transmit mode each time you want to make a call. The transceiver automatically switches to transmit when the VOX feature senses that you have begun speaking into the microphone.

You can switch the VOX feature ON and OFF by pressing the key programmed as **VOX** or by accessing Menu No. 6 {page 11}.

- When **VOX** is activated, the VOX icon () appears on the display.

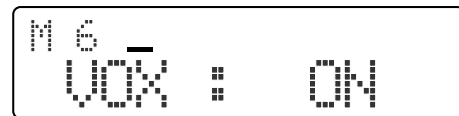

To properly use the VOX feature, you must properly set up the VOX Gain, Anti-VOX Gain, and VOX Delay Time for your environment {see below}.

## VOX GAIN

This setting allows the transceiver to recognize sound levels. If the VOX Gain is too low, the microphone will not pick up your voice when you begin speaking. Be sure to adjust the VOX Gain level to an appropriate sensitivity to allow smooth transmission. Sensitivity levels range from 1 to 9.

You can set the VOX Gain by pressing the key programmed as **VOX Gain** or by accessing Menu No. 8 {page 11}.



## ANTI-VOX GAIN

VOX operation is sometimes difficult when using high speaker volumes. Adjust this control to reduce the tendency of the transceiver to switch into transmit mode due to the speaker output. Use the minimum Anti-Gain level to achieve reliable VOX operation. Anti-Gain levels range from 0 to 9.

You can set the Anti-VOX Gain by pressing the key programmed as **Anti-VOX Gain** or by accessing Menu No. 9 {page 11}.





## VOX DELAY TIME

Set this duration to change the amount of time that the transceiver remains in transmit mode after you stop speaking. Set the duration long enough so that it does not cut off the end of your call. Delay times range from 200 milliseconds to 3000 milliseconds (3 seconds), in steps of 200 milliseconds. You can also set the VOX Delay Time to OFF.

You can set the VOX Delay Time by pressing the key programmed as **VOX Delay** or by accessing Menu No. 7 {page 11}.



## ANTENNA TUNER

In order to use the Antenna Tuner function, you must first attach an optional external KAT-1 antenna tuner to your transceiver.

- 1 Press and hold the key programmed as **Antenna Tuner** for approximately 1 second to start tuning.
  - The transmit indicator lights red and the  icon appears on the display and blinks.
  - To cancel the tuning, press the **Antenna Tuner** key at any time.



- 2 Within 20 seconds, tuning will complete.
  - A tone sounds, the transmit indicator turns off, and the  icon stops blinking and remains on the display.
  - If tuning does not complete within 20 seconds, the tuning action will stop, an error tone will sound, and the antenna will not be tuned to the selected channel.

If set up by your dealer, each time you press the **PTT** switch to transmit, the tuning process will begin if the antenna has not been tuned to the selected channel.

- To cancel the tuning process, press the **Antenna Tuner** key at any time.

## EMERGENCY

If your transceiver has been programmed with the Emergency function, you can make emergency calls. Your dealer can set up the transceiver Emergency function to be accessed via voice, CW, or selcall. Refer to the appropriate section below, depending on how your transceiver has been set up.

---

**Note:** The Emergency feature can be set up onto a foot switch, attached to the AUX terminal, for vehicle use.

---

- 1 Press and hold the key programmed as **Emergency**.
  - Depending on the delay time programmed into your transceiver, the length of time you must hold the **Emergency** key will vary.
  - When the transceiver enters Emergency mode, the transceiver will change to the Emergency channel and begin transmitting based on how the transceiver is set up by your dealer. Transmit periods are also set by your dealer.
  - Depending on your transceiver settings, the display may either remain unchanged when you enter Emergency mode, or a new display with a preprogrammed text message will appear.
- 2 To exit Emergency mode, press and hold the **Emergency** key again.
  - If the Emergency mode completes the preset number of cycles, Emergency mode will automatically end and the transceiver will return to the channel that was in use before Emergency mode was entered.

---

**Note:**

- ◆ Your dealer can set a beginning of transmit and end of transmit tone for the transceiver.
  - ◆ Your dealer can set the transceiver to emit tones and received signals as normal or mute the speaker during Emergency operation.
- 

## CLARIFIER

The Clarifier control changes the receive frequency, without affecting the transmit frequency, by up to  $\pm 400$  Hz.

You can set the Clarifier by pressing the key programmed as **Clarifier** or by accessing Menu No. 2 {page 11}.

- The Clarifier value can be set between  $-400$  Hz and  $+400$  Hz in steps of 10 Hz.
- The  icon appears on the display while the Clarifier is set to a value other than 0 Hz.





## NOISE BLANKER

The Noise Blanker is effective in reducing or eliminating ignition and/or pulse-type noises.

You can turn the Noise Blanker ON or OFF by pressing the key programmed as **Noise Blanker** or by accessing Menu No. 3 {page 11}.

- The  icon appears on the display while the Noise Blanker is ON.



## LCD BRIGHTNESS

You can set the brightness of the display backlight and the key illumination by pressing the key programmed as **LCD Brightness** or by accessing Menu No. 4 {page 11}.

- The brightness levels can be set as High, Low, and Off.
- The key illumination can be set only as on or off.



## POWER-ON TEXT

Your dealer may have programmed your transceiver to display a text message when the transceiver is turned on. This message will appear on the display momentarily before reverting to your regular channel/frequency operation display.



## DISPLAY NAME/ FREQUENCY

You can select whether you want to show a channel name or the frequency of that channel on your transceiver display. You can change the display settings by pressing the key programmed as **Display Character** or by accessing Menu No. 5 {page 11}.

- If your dealer has not set up a name for a particular channel, the channel number will appear instead.



## PRE-AMPLIFIER/ ATTENUATOR

The pre-amplifier allows you to boost the power of the received signal, and the attenuator attempts to cut out any interfering signals you may be receiving.

You can turn the pre-amplifier/ attenuator on or off using the key programmed as **Pre-amplifier/ Attenuator**. Depending on how each channel has been set up by your dealer, pressing the **Pre-amplifier/ Attenuator** key will cycle to the next setting, as displayed below.

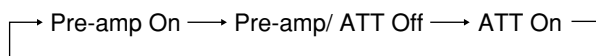

- When the pre-amplifier is ON, the pre-amp icon () appears on the display. (When the pre-amp/ ATT is OFF or when ATT is ON, the icon does not appear on the display.)
- Changing the channel or frequency reverts the setting back to the programmed setting.



## AUXILIARY

If a key has been programmed with the **AUX** function, you can press that key to turn the Auxiliary Port on and off. Ask your dealer for details.

- When the Auxiliary Port is activated, the AUX indicator () appears on the display.

# VGS-1 OPTIONAL VOICE GUIDE & STORAGE UNIT

When using the optional VGS-1 voice guide & storage unit, you gain access to the transceiver's voice recorder and voice announcement functions. Ask your dealer for details.

## VOICE MEMOS

### RECORDING A VOICE MEMO

You can record up to 4 voice memos, each with a duration of up to 15 seconds. To record a voice memo for later playback:

- 1 Press and hold the key programmed as **Playback 1 to 4** for approximately 1 second to begin recording. (Each Playback key corresponds to a memory location of 1 to 4.)
  - The duration of recording memory will appear on the display and begin counting down. The voice memo can record only the received signal.

**Note:** Playback keys can be set up for either voice memos or voice messages by your dealer. The keys function differently depending on how they are set up, so be sure to press a Playback key set up for use for voice memos.

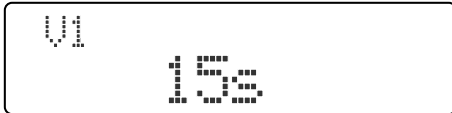

- 2 Press the  $\Delta$  key to end the recording at any time and store it into the transceiver memory.
  - If the memory becomes full, recording will stop automatically and store the voice memo to memory.
  - "WRITING" appears on the display while the recording is being stored to memory.



### PLAYING BACK A VOICE MEMO

To play back a recorded voice memo:

- 1 Press the key programmed as **Playback 1 to 4** to play back the specified voice memo.



- 2 Press the  $\Delta$  key to end the playback at any time.

### DELETING A VOICE MEMO

To delete a recorded voice memo:

- 1 Press the key programmed as **Playback 1 to 4** to select and play back the specified voice memo.
- 2 Press the  $\blacksquare$  key to delete the recording.
  - "DELETE?" appears on the display.



- 3 Press the  $\blacksquare$  key again to confirm the selection and delete the recording from memory.
  - To cancel, press the  $\Delta$  key.

## VOICE MESSAGES

### RECORDING A VOICE MESSAGE

You can record up to 4 voice messages, each with a duration of up to 15 seconds. To record a voice message for later playback/transmission:

- 1 Press and hold the key programmed as **Playback 1 to 4** for approximately 1 second. (Each Playback key corresponds to a memory location of 1 to 4.)
  - "REC/PLAY" appears on the display.
  - Press the  $\Delta$  key to cancel and return to normal operation.

**Note:** Playback keys can be set up for either voice messages or voice memos by your dealer. The keys function differently depending on how they are set up, so be sure to press a Playback key set up for use for voice messages.



- 2 Press the  $\blacksquare$  key and speak into the microphone to begin recording your message.
  - The duration of recording memory will appear on the display and begin counting down.



- 3 Press the  $\Delta$  key to end the recording at any time and store it into the transceiver memory.
  - If the memory becomes full, recording will stop automatically and store the voice message to memory.
  - "WRITING" appears on the display while the recording is being stored to memory.



## PLAYING BACK A VOICE MESSAGE

To play back a recorded voice message:

- 1 Press and hold the key programmed as **Playback 1 to 4** for approximately 1 second.
  - Press the  $\Delta$  key to cancel and return to normal operation.



- 2 Press the **D>** key to begin playback.



- 3 Press the  $\Delta$  key to end the playback at any time.

## TRANSMITTING A VOICE MESSAGE

To transmit a recorded voice message:

- 1 Select the channel on which you want to transmit your recording.
- 2 Press the key programmed as **Playback 1 to 4** to play back and transmit the specified voice message.
- 3 Press the  $\Delta$  key to end the transmission at any time.

## DELETING A VOICE MESSAGE

To delete a recorded voice message:

- 1 Press and hold the key programmed as **Playback 1 to 4** for approximately 1 second to select the specified voice message.



- 2 Press and hold the  $\blacksquare$  key for approximately 1 second to delete the recording.
  - "DELETE?" appears on the display.



- 3 Press the  $\blacksquare$  key again to confirm the selection and delete the recording from memory.
  - To cancel, press the  $\Delta$  key.

## AUTO RECORDING

The auto recording function continuously records all transmitted and received signals. The recording storage area retains 30 seconds of recording, so all transmitted and received signals are simultaneously recorded and erased, leaving only the last 30 seconds of recording in memory.

- The  $\blacksquare$  icon appears on the display while the auto record function is active.

To save the last recording in order for it to be played back, press and hold the key programmed as **Auto Recording** for approximately 1 second.

- "WRITING" appears on the display.



## PLAYING BACK AN AUTO RECORDING

To play back a recording:

- 1 Press the key programmed as **Auto Recording**.
  - "PLAYBACK" appears on the display.



- 2 Press the  $\Delta$  key to end the playback at any time.

## DELETING AN AUTO RECORDING

To delete a recording:

- 1 Press the key programmed as **Auto Recording** to play back the recording.



- 2 Press the  $\blacksquare$  key to delete the recording.
  - "DELETE?" appears on the display.



- 3 Press the  $\blacksquare$  key again to confirm the selection and delete the recording from memory.
  - To cancel, press the  $\Delta$  key.

## VOICE GUIDE

When changing the channel, an audio voice will announce the new channel after it has been selected. This is convenient while driving, as you cannot always check the display to see which channel you have selected. (Voice Annunciation can be activated or deactivated by your dealer.)

# APPENDIX

## KEY FUNCTIONS

Transceiver Key	Normal Operation	Menu Setup Operation	Selcall Operation			
			Selcall Standby Mode	Station Selection Mode	Status Selection Mode	During Call Connection <sup>1</sup>
	Adjust the volume	Adjust the volume	Adjust the volume	Adjust the volume	Adjust the volume	Adjust the volume
	Activate its PF <sup>2</sup>	Return to normal operation	Activate its PF <sup>2</sup>	Return to Selcall Standby mode	Return to Selcall Standby mode	Activate its PF <sup>2,4</sup>
	Activate its PF <sup>2</sup>	No operation <sup>3</sup>	Activate its PF <sup>2</sup>	No operation	No operation	Activate its PF <sup>2,4</sup>
	Activate its PF <sup>2</sup>	No operation	Activate its PF <sup>2</sup>	No operation	No operation	Activate its PF <sup>2,4</sup>
	Activate its PF <sup>2</sup>	Select a parameter	Activate its PF <sup>2</sup>	No operation	Enter Station Selection Mode	Activate its PF <sup>2,4</sup>
	Activate its PF <sup>2</sup>	Select a parameter	Activate its PF <sup>2</sup>	Enter Status Selection mode	No operation	Activate its PF <sup>2,4</sup>
	Activate its PF <sup>2</sup>	No operation	Activate its PF <sup>2</sup>	Begin the call	Begin the call	Activate its PF <sup>2,4</sup>
	Select a channel	Select a menu	Select a channel	Select a station	Select a status	No operation

KMC-32/ KMC-36 Key	Normal Operation	Menu Setup Operation	Selcall Operation			
			Selcall Standby Mode	Keypad Entry Mode	Memory Call Code Selection Mode	During Call Connection <sup>1</sup>
<b>0 ~ 9</b>	No operation	No operation	No operation	Enter a code	No operation	No operation
<b>A</b> <sup>5</sup>	Activate its PF <sup>2</sup>	No operation <sup>3</sup>	Activate its PF <sup>2</sup>	No operation	Select Memory Code A	Activate its PF <sup>2</sup>
<b>B</b> <sup>5</sup>	Activate its PF <sup>2</sup>	No operation	Activate its PF <sup>2</sup>	No operation	Select Memory Code B	Activate its PF <sup>2</sup>
<b>C</b> <sup>5</sup>	Activate its PF <sup>2</sup>	Select a parameter	Activate its PF <sup>2</sup>	No operation	Select Memory Code C	Activate its PF <sup>2</sup>
<b>D</b> <sup>5</sup>	Activate its PF <sup>2</sup>	Select a parameter	Activate its PF <sup>2</sup>	No operation	Select Memory Code D	Activate its PF <sup>2</sup>
<b>*</b>	Activate its PF <sup>2</sup>	Return to normal operation	Turn the Monitor function ON (unmute)	Enter a code	No operation	No operation
<b>#</b>	Activate its PF <sup>2</sup>	No operation	Turn the Monitor function OFF	<ul style="list-style-type: none"> <li>Enter Memory Call Code Selection mode (before entering a code)</li> <li>Begin the call (after entering a code)</li> </ul>	Begin the call (after entering a code)	Return to Selcall Standby mode
<b>PTT</b>	Press to transmit	Press to transmit	Press and hold to enter Keypad Entry mode	Release to return to Selcall Standby mode	Release to return to Selcall Standby mode	Press to transmit

<sup>1</sup> When a call connects, the LED indicator will flash orange.

<sup>2</sup> PF is a Programmable Function.

<sup>3</sup> During Menu Setup operation, when changing the Clarifier frequency, pressing the **A** key (on the transceiver or microphone) will clear the frequency

<sup>4</sup> During Selcall operation, when a call connects, pressing the key programmed as **Monitor** will return the transceiver to Selcall Standby mode.

<sup>5</sup> The KMC-36 does not have keys **A ~ D**.

## Free Manuals Download Website

<http://myh66.com>

<http://usermanuals.us>

<http://www.somanuals.com>

<http://www.4manuals.cc>

<http://www.manual-lib.com>

<http://www.404manual.com>

<http://www.luxmanual.com>

<http://aubethermostatmanual.com>

Golf course search by state

<http://golfingnear.com>

Email search by domain

<http://emailbydomain.com>

Auto manuals search

<http://auto.somanuals.com>

TV manuals search

<http://tv.somanuals.com>