

KENWOOD

DDX672BH
DDX492
DDX415BT
DDX392

DDX372BT
DDX320BT
DDX315
DDX272

MONITOR WITH DVD RECEIVER
INSTRUCTION MANUAL

JVCKENWOOD Corporation



Bluetooth

SIRIUSXM
READY



DOLBY
DIGITAL

HD
DIGITAL

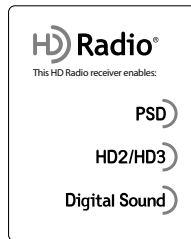

Take the time to read through this instruction manual.

Familiarity with installation and operation procedures will help you obtain the best performance from your new DVD-receiver.

For your records

Record the serial number, found on the back of the unit, in the spaces designated on the warranty card, and in the space provided below. Refer to the model and serial numbers whenever you call upon your Kenwood dealer for information or service on the product.

Model DDX672BH/DDX492/DDX415BT/DDX392/DDX372BT/DDX320BT/DDX315/DDX272 Serial number _____

US Residents Only

Register Online

Register your Kenwood product at www.Kenwoodusa.com

CONTENTS

BEFORE USE	2	OTHER EXTERNAL COMPONENTS	32
How to reset your unit.....	3	Using external audio/video players—AV-IN	32
INITIAL SETTINGS	4	Using a rear view camera	33
BASICS	6	BLUETOOTH (Only for DDX672BH/DDX492/ DDX415BT/DDX392/DDX372BT/DDX320BT)	34
Component names and functions	6	SETTINGS	42
Common operations.....	7	Sound adjustment	42
Common screen operations.....	9	Adjustment for video playback.....	43
Selecting the playback source.....	10	Changing display design.....	45
DISCS	11	Customizing the <TOP MENU> screen	46
USB	15	Customizing the system settings	46
iPod/iPhone	16	Setting menu items.....	48
APPS	19	REMOTE CONTROLLER	51
Pandora® (Only for DDX672BH/DDX492/DDX392/ DDX372BT/DDX320BT/DDX272).....	20	CONNECTION/INSTALLATION	53
TUNER (Only for DDX415BT/DDX392/DDX372BT/ DDX320BT/DDX315/DDX272)	22	REFERENCES	58
HD Radio™ tuner (Only for DDX672BH/DDX492)	24	Maintenance	58
SiriusXM® Satellite RADIO (Only for DDX672BH/ DDX492/DDX392/DDX372BT/DDX320BT/ DDX272)	27	More information	58
		Error message list	61
		Troubleshooting.....	63
		Specifications.....	65

How to read this manual:

- Illustrations of DDX672BH are mainly used for explanation. The displays and panels shown in this manual are examples used to provide clear explanations of the operations. For this reason, they may be different from the actual displays or panels.
- This manual mainly explains operations using the buttons on the monitor panel and touch panel. For operations using the remote controller (RC-DV340: supplied only for DDX415BT/DDX315), see page 51.
- < > indicates the various screens/menus/operations/settings that appear on the touch panel.
- [] indicates the buttons on the touch panel.
- **Indication language:** English indications are used for the purpose of explanation. You can select the indication language from the <Setup> menu. (Page 50)
- Updated information (the latest Instruction Manual, system updates, new functions, etc.) is available from <<http://www.kenwood.com/cs/ce/>>.

BEFORE USE

IMPORTANT

To ensure proper use, please read through this manual before using this product. It is especially important that you read and observe WARNINGS and CAUTIONS in this manual. Please keep the manual in a safe and accessible place for future reference.

⚠ **WARNINGS: (To prevent accidents and damage)**

- DO NOT install any unit or wire any cable in a location where;
 - it may obstruct the steering wheel and gearshift lever operations.
 - it may obstruct the operation of safety devices such as air bags.
 - it may obstruct visibility.
- DO NOT operate the unit while driving. If you need to operate the unit while driving, be sure to look around carefully.
- The driver must not watch the monitor while driving.

For DDX415BT/DDX315:

The marking of products using lasers

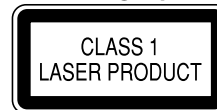

The label is attached to the chassis/case and says that the component uses laser beams that have been classified as Class 1. It means that the unit is utilizing laser beams that are of a weaker class. There is no danger of hazardous radiation outside the unit.

BEFORE USE

For DDX672BH/DDX492/DDX392/DDX372BT/
DDX320BT/DDX272:

⚠ CAUTION

Use of controls or adjustments or performance of procedures other than those specified herein may result in hazardous radiation exposure. In compliance with Federal Regulations, the following are reproductions of labels on, or inside the product relating to laser product safety.

JVC KENWOOD Corporation
2967-3, ISHIKAWA-MACHI, HACHIOJI-SHI, TOKYO, JAPAN

THIS PRODUCT COMPLIES WITH DHHS RULES 21CFR
SUBCHAPTER J IN EFFECT AT DATE OF MANUFACTURE.

Location : Top plate

FCC WARNING

This equipment may generate or use radio frequency energy. Changes or modifications to this equipment may cause harmful interference unless the modifications are expressly approved in the instruction manual. The user could lose the authority to operate this equipment if an unauthorized change or modification is made.

FCC NOTE

This equipment has been tested and found to comply with the limits for a Class B digital device, pursuant to Part 15 of the FCC Rules. These limits are designed to provide reasonable protection against harmful interference in a residential installation.

This equipment may cause harmful interference to radio communications, if it is not installed and used in accordance with the instructions. However, there is no guarantee that interference will not occur in a particular installation. If this equipment does cause harmful interference to radio or television reception, which can be determined by turning the equipment off and on, the user is encouraged to try to correct the interference by one or more of the following measures:

- Reorient or relocate the receiving antenna.
- Increase the separation between the equipment and receiver.
- Connect the equipment into an outlet on a circuit different from that to which the receiver is connected.

- Consult the dealer or an experienced radio/TV technician for help.

For DDX672BH/DDX492/DDX392/DDX372BT/
DDX320BT:

IC (Industry Canada) Notice

This device complies with Industry Canada license-exempt RSS standard(s).

Operation is subject to the following two conditions:

(1) This device may not cause interference, and (2) this device must accept any interference, including interference that may cause undesired operation of the device.

The term "IC:" before the certification/registration number only signifies that the Industry Canada technical specification were met.

CAUTION

This equipment complies with FCC/IC radiation exposure limits set forth for an uncontrolled environment and meets the FCC radio frequency (RF) Exposure Guidelines in Supplement C to OET65 and RSS-102 of the IC radio frequency (RF) Exposure rules. This equipment has very low levels of RF energy that it deemed to comply without maximum permissive exposure evaluation (MPE). But it is desirable that it should be installed and operated keeping the radiator at least 20 cm or more away from person's body (excluding extremities: hands, wrists, feet and ankles). Under Industry Canada regulations, this radio transmitter may only operate using an antenna of a type and maximum (or lesser) gain approved for the transmitter by Industry Canada. To reduce potential radio interference to other users, the antenna type and its gain should be so chosen that the equivalent isotropically radiated power (e.i.r.p.) is not more than that necessary for successful communication.

- Contains Transmitter Module
FCC ID : XQN-BTR60X
- Contains Transmitter Module
IC: 9688A-BTR601

⚠ Cautions on the monitor:

- The monitor built into this unit has been produced with high precision, but it may have some ineffective dots. This is inevitable and is not considered defective.

- Do not expose the monitor to direct sunlight.
- Do not operate the touch panel using a ball-point pen or similar tool with a sharp tip.
Touch the buttons on the touch panel with your finger directly (if you are wearing a glove, take it off).
- When the temperature is very cold or very hot...
 - Chemical changes occur inside, causing malfunction.
 - Pictures may not appear clearly or may move slowly. Pictures may not be synchronized with the sound or picture quality may decline in such environments.

For safety...

- Do not raise the volume level too much, as this will make driving dangerous by blocking outside sounds, and may cause hearing loss.
- Stop the car before performing any complicated operations.

Temperature inside the car...

If you have parked the car for a long time in hot or cold weather, wait until the temperature in the car becomes normal before operating the unit.

❑ How to reset your unit

If the unit fails to operate properly, press the reset button.

DDX672BH



DDX492/DDX415BT/DDX392/DDX372BT/ DDX320BT/DDX315/DDX272



INITIAL SETTINGS

Initial setup

When you power on the unit for the first time or reset the unit, the initial setting screen appears.

- You can also change the settings on the **<Setup>** screen. (Page 48)

1 DDX672BH

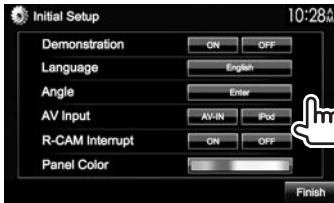

DDX492/DDX415BT/DDX392/DDX372BT/ DDX320BT/DDX315/DDX272

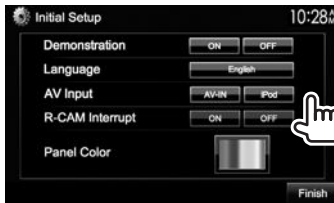

<Demonstration> Activate or deactivate the display demonstration. (Page 49)

<Language> Select the text language used for on-screen information. (Page 50)

- Set **<GUI Language>** to display the operation buttons and menu items in the selected language (**[Local]**: initially selected) or English (**[English]**).

<Angle>* Adjust the panel angle. (Page 8)

<AV Input> Select an external component connected to the iPod/Audio Video input terminal to play. (Page 49)

<R-CAM Interrupt> Select **[ON]** when connecting the rear view camera. (Page 33)

<Panel Color> Select the color of the buttons on the monitor panel. (Page 45)

2 Finish the procedure.



The **<TOP MENU>** screen is displayed.

* Only for DDX672BH.

Setting the security function

❑ Registering the security code (only for DDX415BT/DDX315)

You can set a security code to protect your receiver system against theft.

1 Display the **<TOP MENU>** screen. On the source control screen:



2 Display the **<System>** setting screen.



- Press **[V]** repeatedly to change the page on the **<System>** menu screen.

3 Display the **<Security Code Set>** screen.



- To clear the registered security code, perform steps 1 and 2, then press **[CLR]** in **<Security Code>**.

INITIAL SETTINGS

- 4 Enter a four-digit number (①), then confirm the entry (②).

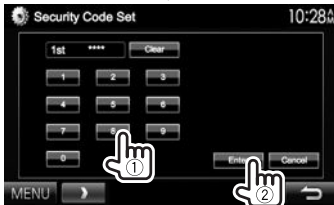

- Press **[Clear]** to delete the last entry.
- Press **[Cancel]** to cancel the setting.

- 5 Repeat step 4 to confirm your security code.

- When the unit is being reset or disconnected from the battery, you are required to enter the security code. Enter the correct security code, then press **[Enter]**.

❑ Activating the security function

You can activate the security function to protect your receiver system against theft.

- 1 Display the **<System>** setting screen.
On the **<TOP MENU>** screen:



- Press **[V]** repeatedly to change the page on the **<System>** menu screen.



The security indicator on the monitor panel flashes when the vehicle ignition is off.

To deactivate the security function: Select **[OFF]** for **<SI>**.

Clock settings

- 1 Display the **<TOP MENU>** screen.
On the source control screen:

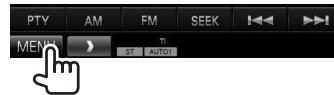

- 2 Display the **<Setup>** screen.



- 3 Display the **<Clock>** screen.

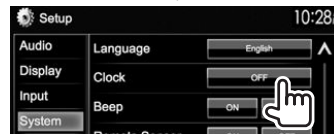

- 4 Set the clock time.



<Radio Data System> Synchronizes the clock time with FM RBDS.

<OFF> Sets the clock manually. (See below.)

When selecting **<OFF>**:
Adjust the hour (①), then adjust the minute (②).

- Press **[Reset]** to set the minute to "00".

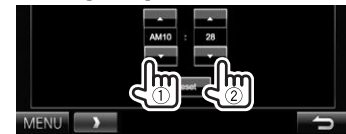

- 5 Finish the procedure.



BASICS

Component names and functions

⚠ Caution on the volume setting:

Digital devices produce very little noise compared with other sources. Lower the volume before playing these digital sources to avoid damaging the speakers by sudden increase of the output level.

DDX672BH

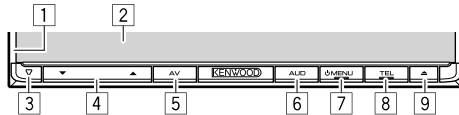

- 1 Monitor panel*
- 2 Screen (touch panel)
- 3 Reset button/Power indicator/Security indicator
 - Resets the unit. (Page 3)
 - Lights up while the unit is turned on.
 - Flashes when the security function is activated. (Page 5)
- 4 Volume ▼/▲ button
 - Adjusts the audio volume. (Page 7)
- 5 AV/R-CAM button
 - Displays the current source screen. (Press)
 - The function of the button when held varies depending on the **<AV Key Long Press>** setting. (Page 50)
- 6 AUD button
 - Displays the **<Equalizer>** screen. (Press) (Page 42)

- 7 **⏻** MENU button
 - Displays the **<TOP MENU>** screen. (Press) (Page 9)
 - Turns on the power. (Press) (Page 7)
 - Turns off the power. (Hold) (Page 7)
- 8 TEL/VOICE button
 - Displays the **<Hands Free>** screen. (Press) (Page 37)
 - Activates voice dialing. (Hold) (Page 39)
- 9 **⏏** (Eject) button
 - Ejects the disc (Tilts the monitor panel fully). (Page 11)
 - Opens/closes the monitor panel.

* You can change the color of the buttons on the monitor panel. (Page 45)

DDX492/DDX392/DDX372BT/DDX320BT/DDX272

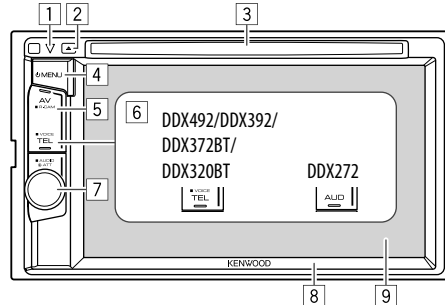

DDX415BT/DDX315

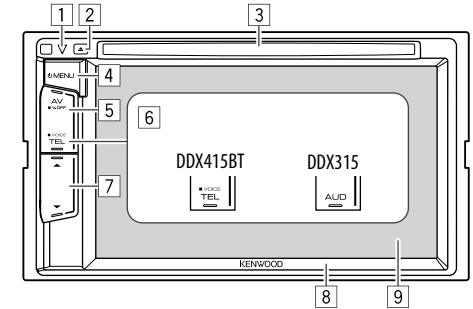

- 1 Reset button/Power indicator/Security indicator
 - Resets the unit. (Page 3)
 - Lights up while the unit is turned on.
 - Flashes when the security function is activated. (Page 5)
- 2 **⏏** (Eject) button
 - Ejects the disc. (Page 11)
- 3 Loading slot
- 4 **⏻** MENU button
 - Displays the **<TOP MENU>** screen. (Press) (Page 9)
 - Turns on the power. (Press) (Page 7)
 - Turns off the power. (Hold) (Page 7)
- 5 **For DDX492/DDX392/DDX372BT/DDX320BT/DDX272:** AV/R-CAM button
 - For DDX415BT/DDX315:** AV/V.OFF button
 - Displays the current source screen. (Press)
 - The function of the button when held varies depending on the **<AV Key Long Press>** setting. (Page 50)

BASICS

6 For DDX492/DDX415BT/DDX392/DDX372BT/ DDX320BT: TEL/VOICE button

- Displays the <Hands Free> screen. (Press) (Page 37)
- Activates voice dialing. (Hold) (Page 39)

For DDX315/DDX272: AUD button

Displays the <Equalizer> screen. (Press) (Page 42)

7 For DDX492/DDX392/DDX372BT/DDX320BT:

Volume/ATT/AUDIO knob

- Attenuates the sound. (Press) (See the far right column.)
- Adjusts the audio volume. (Turn) (See the far right column.)
- Displays the <Equalizer> screen. (Hold) (Page 42)

For DDX272: Volume/ATT knob

- Attenuates the sound. (Press) (See the far right column.)
- Adjusts the audio volume. (Turn) (See the far right column.)

For DDX415BT/DDX315: Volume ▲/▼ buttons
Adjusts the audio volume. (Press) (See the far right column.)

8 Monitor panel*

9 Screen (touch panel)

* You can change the color of the buttons on the monitor panel. (Page 45)

Common operations

Turning on the power DDX672BH



DDX492/DDX415BT/DDX392/ DDX372BT/DDX320BT/ DDX315/DDX272

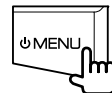

Turning off the power DDX672BH

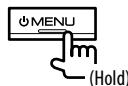

DDX492/DDX415BT/DDX392/ DDX372BT/DDX320BT/ DDX315/DDX272

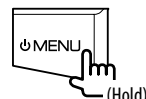

Adjusting the volume

To adjust the volume (00 to 35)
DDX672BH

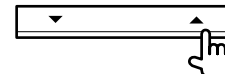

DDX415BT/DDX315

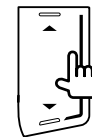

Press ▲ to increase, and press ▼ to decrease.
• Holding the button increases/decreases the volume continuously.

DDX492/DDX392/DDX372BT/ DDX320BT/DDX272

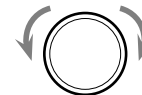

Turn to the right to increase, and turn to the left to decrease.

To attenuate the sound (only for DDX492/ DDX392/DDX372BT/DDX320BT/DDX272)



The ATT indicator lights up.

To cancel the attenuation: Press the same button again.

BASICS

❑ Adjusting the panel angle (only for DDX672BH)

1 Display the <Angle Adjust> screen.

On the <TOP MENU> screen:

- Press [V] repeatedly to change the page on the <Display> menu screen.

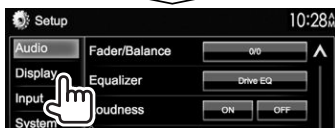

2 Select an angle (0 – 6).

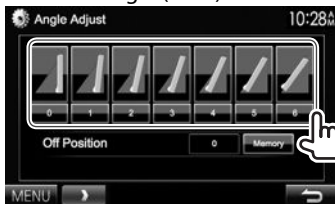

- To set the current position as the power off position, select [Memory] for <Off Position>.

❑ Putting the unit in standby

1 Display all the <TOP MENU> items.

On the <TOP MENU> screen:



2

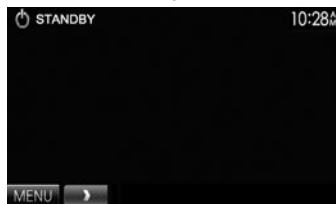

❑ Turning off the screen

- This operation works only when <AV Key Long Press> is set to [V-OFF]. (Page 50)

DDX672BH

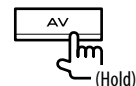

DDX492/DDX392/DDX372BT/ DDX320BT/DDX272



DDX415BT/DDX315



To turn on the screen: Press  MENU on the monitor panel, or touch the display.

BASICS

Common screen operations

Common screen descriptions

You can display other screens any time to change the source, show the information, or change the settings, etc.

Source control screen

Performs source playback operations.

- The operation buttons vary depending on the selected source.

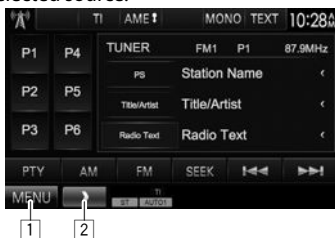

Common operation buttons:

- Displays the <TOP MENU> screen. (See the right column.)
 - Pressing MENU on the monitor panel also displays the <TOP MENU> screen.
- Displays/hides short-cut buttons. (Page 10)

<TOP MENU> screen

Displays the source control screen and settings screen.

- You can arrange the items to display on the <TOP MENU> screen (Page 46)



Common operating buttons:

- Changes the playback source. (Page 10)
- Displays all playback sources and items. (Page 10)
- Displays the <Setup> screen. (See below.)

<Setup> screen

Changes the detailed settings. (Page 48)



Common operating buttons:

- Selects the menu category.
- Displays the <TOP MENU> screen.
- Changes the page.
- Returns to the previous screen.

Touch screen operations

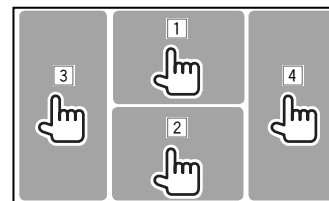

- Displays the video control menu while playing a video.

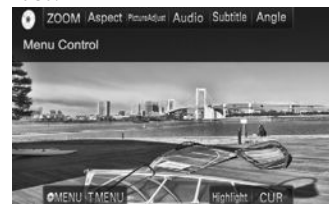

- Displays the source control screen while playing a video.



- The operation buttons disappear when the screen is touched or when no operation is done for about 5 seconds.
- Goes to the previous chapter/track.*
 - Goes to the next chapter/track.*

* Not available for video from an external component.

BASICS

Selecting the playback source

On the **<TOP MENU>** screen:



- [DISC]** Plays a disc. (Page 11)
- [HD Radio]*1** Switches to the HD Radio broadcast. (Page 24)
- [TUNER]*2** Switches to the conventional radio broadcast. (Page 22)
- [iPod]** Plays an iPod/iPhone. (Page 16)
- [USB]** Plays files on a USB device. (Page 15)
- [SiriusXM]*3** Switches to the SiriusXM® Satellite Radio broadcast. (Page 27)
- [PANDORA]*3** Switches to the Pandora broadcast. (Page 20)
- [Bluetooth]*4** Plays a Bluetooth audio player. (Page 41)
- [APPs]*5** Switches to the App screen on the connected iPod touch/iPhone. (Page 19)

- [TEL]*4** Displays the **<Hands Free>** screen. (Page 37)
- [AV-IN1]*6** Switches to an external component connected to the Audio Video input terminal. (Page 32)
- [AV-IN]*3 *5** or **[AV-IN2]*5 *6** Switches to an external component connected to the iPod/Audio Video input terminal. (Page 32)

- *1 Only for DDX672BH/DDX492.
- *2 Only for DDX415BT/DDX392/DDX372BT/DDX320BT/DDX315/DDX272.
- *3 Only for DDX672BH/DDX492/DDX392/DDX372BT/DDX320BT/DDX272.
- *4 Only for DDX672BH/DDX492/DDX415BT/DDX392/DDX372BT/DDX320BT.
- *5 Select an appropriate input setting in **<AV Input>**. (Page 49)
- *6 Only for DDX415BT/DDX315.

□ Selecting the playback source on the **<TOP MENU>** screen



- You can change the items (other than **[SETUP]**) to display on the **<TOP MENU>** screen. (Page 46)

□ Using short-cut buttons

While displaying the source control screen or the **<Setup>** screen, you can use the short-cut buttons to go to the items on the **<TOP MENU>** screen indicated below.

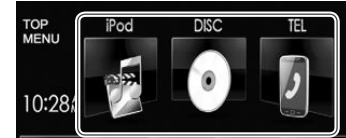

To display the short-cut buttons



On the source control screen:



On the **<Setup>** screen:



To hide the short-cut buttons: Press [].

DISCS

Playing a disc

- If a disc does not have a disc menu, all tracks on it will be played repeatedly until you change the source or eject the disc.
- For playable disc types/file types, see page 59.

❑ Inserting a disc

Insert a disc with the label side facing up.

DDX672BH

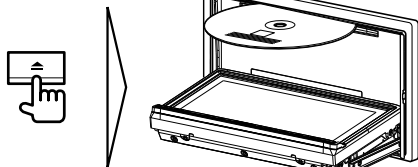

**DDX492/DDX392/
DDX372BT/
DDX320BT/DDX272**

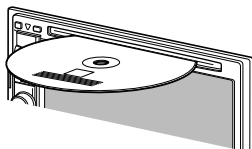

DDX415BT/DDX315

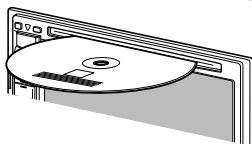

The source changes to "DISC" and playback starts.

- The IN indicator lights up while a disc is inserted.

- If "⊘" appears on the screen, the unit cannot accept the operation you have tried to do.
 - In some cases, without showing "⊘," operations will not be accepted.
- When playing back a multi-channel encoded disc, the multi-channel signals are downmixed to stereo.

❑ Ejecting a disc

DDX672BH



**DDX492/DDX415BT/DDX392/
DDX372BT/DDX320BT/DDX315/
DDX272**

- When removing a disc, pull it horizontally.
- You can eject a disc when playing another AV source.
- If the ejected disc is not removed within 15 seconds, the disc is automatically inserted again into the loading slot to protect it from dust.

Closing the monitor panel (only for DDX672BH)

After removing the disc, press  on the monitor panel. The monitor panel closes.

Playback operations

- When the operation buttons are not displayed on the screen, touch the area shown on the illustration.
- To change settings for video playback, see page 43.

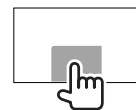

❑ Indications and buttons on the source control screen

For video playback



Playback information

- The information displayed on the screen differs depending on the type of disc/file being played back.

- 1 Media type
- 2 Current playback item information (title no./chapter no./folder no./file no./track no.)
- 3 Playing time
- 4 Playback mode (Page 14)
- 5 File type
- 6 IN indicator

DISCS

Operation buttons

- Available buttons on the screen and operations differ depending on the type of disc/file being played back.

[MODE]

Changes the settings for disc playback on the <DISC Mode> screen. (Page 14)



Selects a folder.



Selects playback mode. (Page 14)



Displays the folder/track list. (See the far right column.)



Stops playback.



Starts/pauses playback.

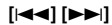

- Selects a chapter/track. (Press)
- Reverse/forward search. (Hold)



- Reverse/forward search during playback.
- Plays back in slow-motion during pause.

[MENU]

Displays the <TOP MENU> screen.

For audio playback



Playback information

- The information displayed on the screen differs depending on the type of disc/file being played back.

1 Media type

2 Track/file information

- Pressing [◀] scrolls the text if not all of the text is shown.

3 Current playback item information (folder no./file no./track no.)

4 Playback status

5 Playing time

6 Jacket picture (Shown while playing if the file has tag data that includes the jacket picture)

7 Playback mode (Page 14)

8 File type

9 IN indicator

Operation buttons

- Available buttons on the screen and operations differ depending on the type of disc/file being played back.

[MODE]

Changes the settings for disc playback on the <DISC Mode> screen. (Page 14)



Selects a folder.



Selects playback mode. (Page 14)



Displays the folder/track list. (See the right column.)



Starts/pauses playback.



Selects a track.



Reverse/forward search.

[MENU]

Displays the <TOP MENU> screen.

Selecting a folder/track on the list

1



2 Select the folder (①), then the item in the selected folder (②).

- Repeat the procedure until you select the desired track.
- If you want to play all tracks in the folder, press [▶] on the right of the desired folder.



- You can change the page to display more items by pressing [▲]/[▼].
- Press [⏪] to return to the root folder.
- Press [▶] to return to the upper layer.

DISCS

❑ Video menu operations

You can display the video menu screen during video playback.

- The operation buttons disappear when the screen is touched or when no operation is done for about 5 seconds.

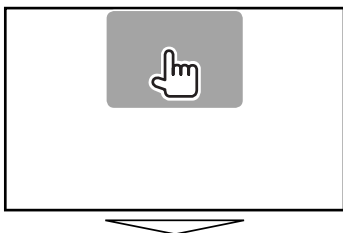

For video playback except VCD



- Available buttons on the screen and operations differ depending on the type of disc/file being played back.

[ZOOM] Displays the picture size selecting screen. (Page 44)

[Aspect] Selects the aspect ratio. (Page 44)

[Picture Adjust] Displays the picture adjustment screen. (Page 43)

[Audio] Selects the audio type.

[Subtitle] Selects the subtitle type.

[Angle] Selects the view angle.

[MENU] Displays the disc menu (DVD).

[T MENU] Displays the disc menu (DVD).

[Highlight] Switches to the direct disc menu mode. Touch the target item to select.

- To restore the screen, press AV on the monitor panel.

[CUR] Displays the menu/scene selecting screen.

- **[▲]** **[▼]** **[◀]** **[▶]**: Selects an item.
 - For DivX®: **[◀]** **[▶]** skips back or forward by about 5 minutes.
- **[Enter]**: Confirms the selection.
- **[Return]**: Returns to the previous screen.

For VCD



[MENU] Displays the disc menu.

[Direct] Displays/hides the direct selecting buttons. (See below.)

[Audio] Selects the audio channel (ST: stereo, L: left, R: right).

[Return] Displays the previous screen or menu.

[ZOOM] Displays the picture size selecting screen. (Page 44)

[Aspect] Selects the aspect ratio. (Page 44)

[Picture Adjust] Displays the picture adjustment screen. (Page 43)

- To deactivate the PBC function, stop playback, then use the direct selecting buttons to select a track number.

To select a track directly on a VCD



- When you enter a wrong number, press **[Direct/CLR]** to delete the last entry.

DISCS

❑ Selecting playback mode



[X] Selects Random playback mode.

[O] Selects Repeat playback mode.

- Available playback modes differ depending on the type of disc/file being played back.
- You cannot activate the repeat mode and the random mode at the same time.
- Each time you press the button, the playback mode changes. (The corresponding indicator lights up.)
 - Available items differ depending on the type of disc/file being played back.

C-REP Repeats current chapter.

T-REP Repeats current title.

REP Repeats current track.

FO-REP Repeats all tracks of the current folder.

FO-RDM Randomly plays all tracks of the current folder, then tracks of the next folder.

RDM Randomly plays all tracks.

To cancel Repeat/Random playback: Press the button repeatedly until the indicator disappears.

Settings for disc playback

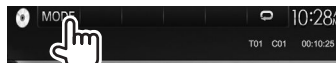

❑ Setting items

- Available items shown on the <DISC Mode> screen differ depending on the type of disc/file being played back.

<Menu Language>	Select the initial disc menu language. (Initial: English) (Page 61)
<Audio Language>	Select the initial audio language. (Initial: English) (Page 61)
<Subtitle Language>	Select the initial subtitle language or turn subtitles off (Off). (Page 61) <ul style="list-style-type: none"> • Initial for DDX672BH/DDX492/DDX392/DDX372BT/DDX320BT/DDX272: Off, for DDX415BT/DDX315: English
<Down Mix>	When playing back a multi-channel disc, this setting affects the signals reproduced through the front and/or rear speakers. <ul style="list-style-type: none"> • Dolby Surround: Select this to enjoy multi-channel surround sound by connecting an amplifier compatible with Dolby Surround. • Stereo (initial): Normally select this.

<Dynamic Range Control>

You can change the dynamic range while playing Dolby Digital software.

- **Wide:** Select this to enjoy a powerful sound at a low volume level with its full dynamic range.
- **Normal:** Select this to reduce the dynamic range a little.
- **Dialog** (initial): Select this to reproduce movie dialog more clearly.

<Screen Ratio>

Select the monitor type to watch a wide screen picture on the external monitor.

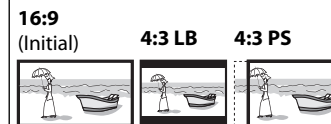

<File Type>*

Select the playback file type when a disc contains different types of files.

- **Audio:** Plays back audio files.
- **Still Image:** Plays back picture files.
- **Video:** Plays back video files.
- **Audio&Video** (initial): Plays back audio files and video files.

* For playable file types, see page 59.
If the disc contains no files of the selected type, the existing files are played in the following priority: audio, video, then still picture.

USB

Connecting a USB device

You can connect a USB mass storage class device such as a USB memory, Digital Audio Player etc. to the unit.

- For details about connecting USB devices, see page 56.
- You cannot connect a computer or portable HDD to the USB input terminal.
- For playable file types and notes on using USB devices, see page 60.

When a USB device is connected...

The source changes to “USB” and playback starts.

- All tracks in the USB device will be played repeatedly until you change the source.

To disconnect the USB device safely:

Press [▲], then disconnect the USB device after “No Device” appears.

Playback operations

When the operation buttons are not displayed on the screen, touch the area shown on the illustration.

- To change settings for video playback, see page 43.

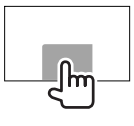

Indications and buttons on the source control screen



Playback information

- The information displayed on the screen differs depending on the type of file being played back.

- 1 Track/file information
 - Pressing [◀] scrolls the text if not all of the text is shown.
- 2 Current playback item information (folder no./file no.)
- 3 Playback status
- 4 Playing time
- 5 Jacket picture (Shown while playing if the file has tag data that includes the jacket picture)
- 6 Playback mode (See the right column.)
- 7 File type

Operation buttons

- Available buttons on the screen and operations differ depending on the type of file being played back.

[MODE]

Changes the settings on the <USB Mode> screen. (Page 16)



Disconnects the USB device safely.



Selects a folder.



Selects random playback mode.*1 *2

- **FO-RDM**: Randomly plays all tracks in the folder.
- **RDM**: Randomly plays all tracks.
- **REP**: Repeats the current track.
- **FO-REP**: Repeats all tracks in the current folder.



Selects repeat playback mode.*1 *2



Displays the folder/track list. (Page 16)



Starts/pauses playback.



Selects a track.



Reverse/forward search.

[MENU]

Displays the <TOP MENU> screen.

*1 To cancel random or repeat mode, press the button repeatedly until the indicator disappears.

*2 You cannot activate the repeat mode and the random mode at the same time.

USB

❑ <USB Mode> settings

Setting <File Type>

- [Audio]** Plays back audio files.
[Still Image] Plays back picture files.
[Video] Plays back video files.
[Audio&Video] Plays back audio files and video files.
(Initial)

- For playable files, see page 60. If the USB device contains no files of the selected type, the existing files are played in the following priority: audio, video, then still picture.

Setting <Screen Ratio>

Select the monitor type to watch a wide screen picture on the external monitor.

[16:9] (Initial)



[4:3 LB]



[4:3 PS]



Setting <Drive Select>

Press **[Next]**. Switches between internal memory and the memory source of the connected device (such as mobile phone).

❑ Selecting a folder/track on the list

1



2 Select the folder (①), then the item in the selected folder (②).

- Repeat the procedure until you select the desired track.
- If you want to play all tracks in the folder, press **[▶]** on the right of the desired folder.

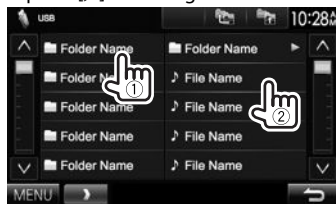

- You can change the page to display more items by pressing **[▲]/[▼]**.
- Press **[⏪]** to return to the root folder.
- Press **[⏩]** to return to the upper layer.

iPod/iPhone

Preparation

❑ Connecting iPod/iPhone

- For details about connecting iPod/iPhone, see page 56.
- For playable iPod/iPhone types, see page 60.

Connect your iPod/iPhone using the appropriate cable according to your purpose.

- **To listen to music:** USB Audio cable for iPod/iPhone
 - For iPod/iPhone except for iPod nano (7th Generation)/iPod touch (5th Generation)/iPhone 5S/iPhone 5C/iPhone 5: KCA-iP102 (optional accessory)
 - For iPod nano (7th Generation)/iPod touch (5th Generation)/iPhone 5S/iPhone 5C/iPhone 5: KCA-iP103 (optional accessory)
- **To watch video and listen to music:** USB Audio and Video cable for iPod/iPhone—KCA-iP202 (optional accessory)
 - You cannot connect iPod nano (7th Generation)/iPod touch (5th Generation)/iPhone 5S/iPhone 5C/iPhone 5 with KCA-iP202.

iPod/iPhone

❑ Selecting preference settings for iPod/iPhone playback

When the source is "iPod"...

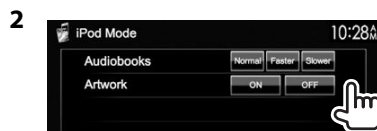
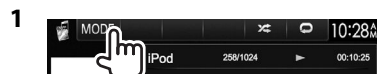

<Audiobooks> Select the speed of audio books.

<Artwork> Shows/hides artwork of iPod.

❑ Setting <AV Input> for iPod/iPhone playback

Select an appropriate input setting for <AV Input> according to the connection method of the iPod/iPhone.

- You can change the setting only when [STANDBY] is selected on <TOP MENU>. (Page 8)

- 1 Display the <Input> setting screen.
On the <TOP MENU> screen:

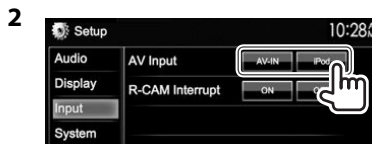
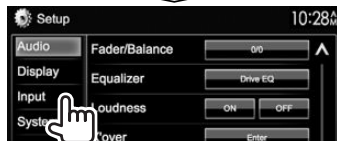

[AV-IN]*1/ [AV-IN2]*2 Select this when the iPod/iPhone is connected using KCA-iP102 or KCA-iP103 (optional accessory).

[iPod] Select this when the iPod/iPhone is connected using KCA-iP202 (optional accessory).

*1 Only for DDX672BH/DDX492/DDX392/DDX372BT/DDX320BT/DDX272.

*2 Only for DDX415BT/DDX315.

Playback operations

When the operation buttons are not displayed on the screen, touch the area shown on the illustration.

- To change settings for video playback, see page 43.

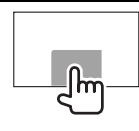

❑ Indications and buttons on the source control screen

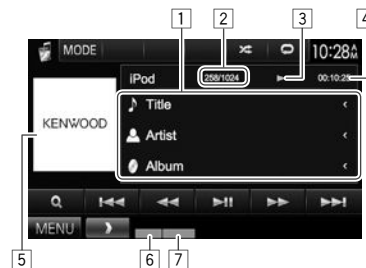

Playback information

- Song/video information
 - Pressing [<] scrolls the text if not all of the text is shown.
- Track no./Total track number
- Playback status
- Playing time
- Artwork (Shown if the song contains Artwork)
 - To change the Artwork display, see the far left column.
- Playback mode (Page 18)
- File type

iPod/iPhone

Operation buttons

[MODE] Changes the settings for iPod/iPhone playback on the <iPod Mode> screen. (Page 17)

[X] Selects random playback mode.*1

- **RDM:** Functions the same as Shuffle Songs.
- **A-RDM:** Functions the same as Shuffle Albums.

[O] Selects repeat playback mode.

- **REP:** Functions the same as Repeat One.
- **ALL REP:** Functions the same as Repeat All.

[Q] Displays the audio/video file list. (See the right column.)

[▶||] Starts/pauses playback.

[◀◀] [▶▶] Selects an audio/video file.*2

[◀◀] [▶▶] Reverse/forward search.

[MENU] Displays the <TOP MENU> screen.

*1 To cancel random mode, press the button repeatedly until the indicator disappears.

*2 Resume playback is unavailable for video files.

□ Selecting an audio/video file from the menu



2 Select the menu (🎵: audio or 🎬: video) (①), a category (②), then a desired item (③).

- Select the item in the selected layer until a desired file starts playing.
- If you want to play all items in the layer, press [▶] on the right of the desired item.

Audio menu:

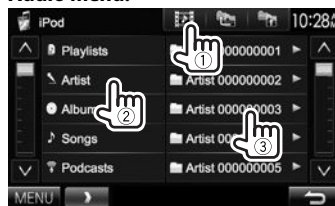

Video menu:

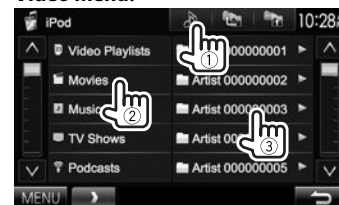

- You can change the page to display more items by pressing [▲]/[▼].
- Press [⏪] to return to the root folder.
- Press [⏩] to return to the upper layer.
- Available categories differ depending on the type of your iPod/iPhone.

APPs

You can use Apps of the connected iPod touch/iPhone on this unit.

- You cannot use Apps with iPod touch (5th Generation)/iPhone 5S/iPhone 5C/iPhone 5.

Preparation

- 1 Connect iPod touch/iPhone using KCA-iP202. (Page 56)
- 2 Select **[iPod]** for **<AV Input>**. (Page 17)

Using an App

When the operation buttons are not displayed on the screen, touch the screen to show them.

- To change settings for video playback, see page 43.

Playback operations

- 1 Start the App on your iPod touch/iPhone.
- 2 Select **"APPs"** as the source.

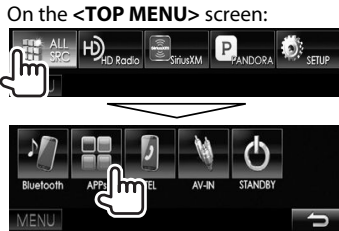

Operation buttons on the source control screen



- [▶] Starts playback.
- [⏸] Pauses playback.
- [◀▶] Selects an audio/video file.
- [▶⏸] Starts/pauses playback.
- [◀▶] Reverse/forward search.
- [MENU] Displays the **<TOP MENU>** screen.

- You can operate some functions of the App on the touch panel.
- For some applications such as navigation applications, the operation buttons and information are not shown. You can perform the operations on the touch panel, such as scrolling the map.
 - If "⊘" appears on the screen, the unit cannot accept the touch operation you have tried to do.
- You can also play back the audio/video using iPod/iPhone itself instead of the unit.

Switching to the App screen while listening to another source

- This operation works only when **<AV Key Long Press>** is set to **[APPs]**. (Page 50)

DDX672BH

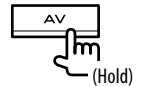

DDX492/DDX392/DDX372BT/
DDX320BT/DDX272

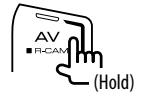

DDX415BT/DDX315

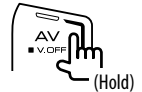

You can stream Pandora from iPod touch/iPhone via a wired connection or from Android or BlackBerry devices through Bluetooth.

- Install the latest version of the Pandora application on your iPod touch/iPhone/Android/BlackBerry.
- Android/BlackBerry devices can only be used with DDX672BH/DDX492/DDX392/DDX372BT/DDX320BT.

Preparation

Connect the device, then start the Pandora application.

For Android/BlackBerry

- 1 Pair the Android/BlackBerry device through Bluetooth. (Page 34)
- 2 Select **"PANDORA"** as the source. (Page 10)
- 3 Connect the Android/BlackBerry device for using Pandora on the **<Bluetooth Setup>** screen. (Page 36)

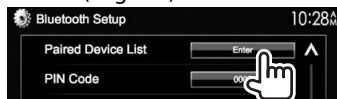

"Connected" appears. Press **[OK]** to confirm the operation.
When the connection is established, the Pandora application is started and the **"PANDORA"** source control screen is displayed.

For iPod touch/iPhone

- 1 Connect the iPod touch/iPhone to the USB terminal using KCA-iP202, KCA-iP102 or KCA-iP103 (optional accessory). (Page 56)
- 2 Start the Pandora application on the connected iPod touch/iPhone.
The **"PANDORA"** source control screen is displayed.

Playback operations

You can operate Pandora using the remote controller. Only playing, pausing, and skipping are available.

Indications and buttons on the source control screen



Playback information

- 1 Picture data (Shown if available from current content and when iPod touch/iPhone is connected via USB)
- 2 Track information
 - Pressing [**<**] scrolls the text if not all of the text is shown.
- 3 Playback status
- 4 Playing time

Operation buttons

- [**👤**] Bookmarks the artist.
- [**🎵**] Bookmarks the current track.
- [**👤+**] Adds the current artist to the Station List.
- [**🎵+**] Adds the current track to the Station List.
- [**🔍**] Displays the list selecting screen. (Page 21)
- [**👍**] Thumbs down to the current track and skips to the next track.
- [**👍**] Registers the current track as a favorite.
- [**⏸**] Starts/pauses playback.
- [**⏭**] Skips the current track.
 - Not available when the Pandora skip reaches its limit.
- [**[MENU]**] Displays the **<TOP MENU>** screen.

Pandora®

❑ Selecting a station from the list

1 Display the list selecting screen.



2 Select the list type.

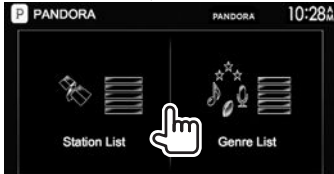

<Station List> Selects from the station names (Station List).

<Genre List> Selects from the genre names (Genre List).

3 Select a station from the list.

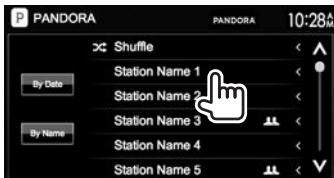

On the Station List



[Shuffle] Plays all the songs in the registered stations randomly.

[By Date] Sorts the list in reverse chronological order.

[By Name] Sorts the list in alphabetical order.

- You can change the page to display more items by pressing [▲]/[▼].
- The  indicator appears on the left of the item when Shuffle is activated. (All songs on the registered stations are played randomly.)
- The  indicator appears on the right of the item when the station is shared.

On the Genre List

Select a genre (①), then a station (②).



- You can change the page to display more items by pressing [▲]/[▼].
- The selected station is added to the Station List.

Requirements for Pandora®

iPhone or iPod touch

- Install the latest version of the Pandora application on your iPhone or iPod touch. (Search for "Pandora" in the Apple iTunes App Store to find and install the most recent version.)
- Connect iPod touch/iPhone to this unit with KCA-iP202, KCA-iP102 or KCA-iP103 (optional accessory).

Android™

- Visit Google play and search for Pandora to install.
- Bluetooth must be built in and the following profiles must be supported.
 - SPP (Serial Port Profile)
 - A2DP (Advanced Audio Distribution Profile)

BlackBerry®

- Visit www.pandora.com from the built in browser to download the Pandora application.
- Bluetooth must be built in and the following profiles must be supported.
 - SPP (Serial Port Profile)
 - A2DP (Advanced Audio Distribution Profile)

NOTE

- Ensure you are logged in to your smartphone application. If you do not have a Pandora account, you can create one for free from your smartphone or at www.pandora.com.
- Pandora is available only in the U.S./Australia/New Zealand.
- Because Pandora is a third-party service, the specifications are subject to change without prior notice. Accordingly, compatibility may be impaired or some or all of the services may become unavailable.
- Some functions of Pandora cannot be operated from this unit.
- For issues using the application, contact Pandora at pandora-support@pandora.com
- Establish an Internet connection using LTE, 3G, EDGE, or WiFi.

Listening to the radio

Indications and buttons on the source control screen



Tuner reception information

- 1 Band
- 2 Preset no.
- 3 The station frequency currently tuned in
- 4 ST/MONO indicator
 - The ST indicator lights up when receiving an FM stereo broadcast with sufficient signal strength.
- 5 Seek mode
- 6 TI indicator
- 7 Text information
 - Pressing [**<**] scrolls the text if not all of the text is shown.
 - Pressing [**Radio Text**] switches the information between Radio Text, Radio Text Plus, and PTY code.

Operation buttons

- [P1] – [P6] • Selects a stored station. (Press)
• Stores the current station. (Hold)
- [TI]* Activates/deactivates TI standby reception mode. (Page 23)
- [AME] Presets stations automatically. (See the right column.)
- [MONO]* Activates/deactivates monaural mode for better FM reception. (Stereo effect will be lost.)
• The MONO indicator lights up while monaural mode is activated.
- [TEXT] Changes the display information. (See the right column.)
- [PTY]* Enters PTY search mode. (Page 23)
- [AM] Selects the AM band.
- [FM] Selects the FM band.
→ FM1 → FM2 → FM3 →
- [SEEK] Changes the seek mode.
 - **AUTO1**: Auto Search
 - **AUTO2**: Tunes in stations in the memory one after another.
 - **MANU**: Manual Search
 Searches for a station.
 - The search method differs according to the selected seek mode. (See above.)
- [<<] [>>] • The search method differs according to the selected seek mode. (See above.)
- [MENU] Displays the <TOP MENU> screen.

* Appears only when FM is selected as the source.

Changing the display information



- The preset list containing the station names for FM RBDS (when a PS signal is coming in) is displayed.
- Press [**TEXT**] again to display the text information for the station currently being received.

Presetting stations

Storing stations in the memory

You can preset 6 stations for each band.

Automatic presetting—AME (Auto Memory)



Local stations with the strongest signals are found and stored automatically.

TUNER

Manual presetting

- 1 Tune in to a station you want to preset.
(Page 22)
- 2 Select a preset number.



The station selected in step 1 is stored.

□ Selecting a preset station



FM RBDS features

□ Searching for FM RBDS programs—PTY Search

You can search for your favorite programs being broadcast by selecting the PTY code.

1



2 Select a PTY code.



- You can change the page to display more items by pressing [▲]/[▼].

PTY Search starts.

If there is a station broadcasting a program of the same PTY code as you have selected, that station is tuned in.

□ Activating/deactivating TI Standby Reception



The unit is in standby to switch to Traffic Information (TI) if available. (The TI indicator lights up in white.)

- If the TI indicator is lit in orange, tune into another station providing RBDS signals.

To deactivate TI Standby Reception: Press [TI].
(The TI indicator turns off.)

- The volume adjustment for Traffic Information is automatically memorized. The next time the unit switches to Traffic Information, the volume is set to the previous level.

HD Radio™ tuner (Only for DDX672BH/DDX492)

About HD Radio™ Technology

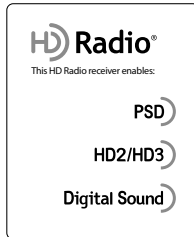

PSD

- Program Service Data provides song name, artist, station ID, and other relevant data streams

HD2/HD3

- Adjacent to traditional main stations are HD2/HD3 Channels, providing new original formats on the FM dial

Digital Sound

- HD Radio broadcasts deliver crystal clear, CD-like digital audio quality to consumers

Listening to the HD Radio™ broadcast

Indications and buttons on the source control screen

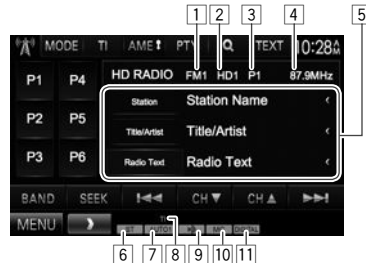

HD Radio reception information

- 1 Band
- 2 Channel no.
- 3 Preset no.
- 4 The station frequency currently tuned in
- 5 Text information
 - Pressing [**<**] scrolls the text if not all of the text is shown.
 - Pressing [**Radio Text**] switches the information between Radio Text, Message and PTY code.
- 6 ST indicator: Lights up when receiving an FM stereo broadcast with sufficient signal strength.
- 7 Seek mode
- 8 TI indicator
- 9 HD indicator: Lights up when receiving an HD Radio broadcast.
- 10 MC indicator: Lights up when receiving an HD Radio multicast channel.
- 11 HD Radio reception mode (Page 25)
 - When receiving digital signals, the DIGITAL indicator lights up.

- When receiving analog signals, the ANALOG indicator lights up.

Operation buttons

- [P1] – [P6] • Selects a stored station. (Press)
• Stores the current station. (Hold)
- [MODE] Changes the settings for HD Radio tuner reception on the **<HD RADIO Mode>** screen. (Page 25)
- [TI]* Activates/deactivates TI standby reception mode. (Page 25)
- [AME] ↓ Presets stations automatically. (Page 26)
- [PTY]* Enters PTY search mode. (Page 26)
- [Q] Displays the **<Preset List>** screen. (Page 26)
- [TEXT] Displays/hides the information of the current station.
- [BAND] Selects the band.
→ FM1 → FM2 → FM3 → AM
- [SEEK] Changes the seek mode.
 - **AUTO1**: Auto Search
 - **AUTO2**: Tunes in stations in the memory one after another.
 - **MANU**: Manual Search
- [◀▶] Searches for a station.
 - The search method differs according to the selected seek mode. (See above.)
- [CH▼] Selects a sub-channel when receiving an HD Radio multicast channel.
- [CH▲] Selects a sub-channel when receiving an HD Radio multicast channel.
- [MENU] Displays the **<TOP MENU>** screen.

* Appears only when FM is selected as the source.

HD Radio™ tuner

❑ Changing the display information



The preset list containing the station names is displayed.

- Press **[TEXT]** again to display the text information for the station currently being received.

❑ Changing the HD Radio reception mode

While receiving an HD Radio broadcast, the unit tunes in digital or analog audio automatically according to the receiving condition.

1



2



- [Auto]** Switch between digital and analog audio automatically.
- [Digital]** Select this to tune in digital audio only.
- [Analog]** Select this to tune in analog audio only.

❑ Activating/deactivating TI Standby Reception



The unit is in standby to switch to Traffic Information (TI) if available. (The TI indicator lights up in white.)

- If the TI indicator is lit in orange, tune into another station.

To deactivate TI Standby Reception: Press **[TI]**. (The TI indicator turns off.)

- The volume adjustment for Traffic Information is automatically memorized. The next time the unit switches to Traffic Information, the volume is set to the previous level.

HD Radio™ tuner

❑ Searching for FM HD Radio programs—PTY Search

You can search for your favorite programs being broadcast by selecting the PTY code.

1



2 Select a PTY code.

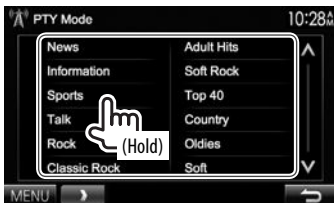

- You can change the page to display more items by pressing [▲]/[▼].

PTY Search starts.

If there is a station broadcasting a program of the same PTY code as you have selected, that station is tuned in.

Presetting stations

❑ Storing stations in the memory

You can preset 6 stations for each band.

Automatic presetting—AME (Auto Memory)



Local stations with the strongest signals are found and stored automatically.

Manual presetting

- 1 Tune in to a station you want to preset. (Page 24)
- 2 Select a preset number.



The station selected in step 1 is stored.

❑ Selecting a preset station from the list

1



2 Select a station from the list.



- You can change the page to display more items by pressing [▲]/[▼].

SiriusXM® Satellite RADIO (Only for DDX672BH/DDX492/DDX392/DDX372BT/DDX320BT/DDX272)

Only SiriusXM® brings you more of what you love to listen to, all in one place. Get over 140 channels, including commercial-free music plus the best sports, news, talk, comedy and entertainment. Welcome to the world of satellite radio. A SiriusXM Vehicle Tuner and Subscription are required. For more information, visit www.siriusxm.com.

Activating subscription

1 Check your Radio ID.

The SiriusXM Satellite Radio ID is required for activation and can be found by tuning to Channel 0 as well as on the label found on the SiriusXM Connect tuner and its packaging.

- The Radio ID does not include the letters I, O, S or F.

2 Activate the SiriusXM Connect Vehicle Tuner using one of the two methods below:

- For users in U.S.A.:
 - Online:
Visit www.siriusxm.com/activatenow
 - Phone: Call SiriusXM Listener Care at 1-866-635-2349
- For users in Canada:
 - Online:
Visit www.siriusxm.ca/activatexm
 - Phone: Call XM customer Care at 1-877-438-9677

3 When the following screen appears, press [Enter].

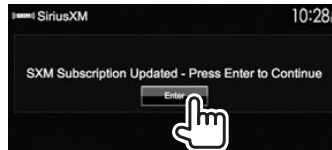

Listening to the SiriusXM® Satellite Radio

Indications and buttons on the source control screen



SiriusXM® Satellite Radio reception information

- 1 Band
- 2 Preset number
- 3 Information for the buffered data and the replay mode (Page 29)
- 4 Channel number
- 5 Seek mode
- 6 Signal strength indicator
- 7 Text information
 - Pressing [**<**] scrolls the text if not all of the text is shown.

Operation buttons

[P1] – [P6]

- Selects a stored channel. (Press)
- Stores the current channel. (Hold)

[Song Title]/ [Content Info]/ [Category] [MODE]

Changes the displayed information each time this button is pressed.

Changes the settings for Sirius XM Satellite Radio reception on the **<SiriusXM Mode>** screen. (Pages 29 – 31)

[◀◀] [▶▶]

Skips or rewinds/fast forwards the content during replay mode. (Page 29)

[SCAN]

Scans the first 6 seconds of the buffered contents of the preset channels and the currently tuned channel. (Page 30)

[Live]

Returns to the live position from the replay mode. (Page 29)

[TEXT]

Displays/hides the information of the current channel. (Page 28)

[▶||]

Starts/pauses the content replay. (Page 29)

[Q]

Obtain information on channels or select a category and then a channel. (Page 28)

[BAND]

Selects the band.

▶ SXM1 ▶ SXM2 ▶ SXM3 ▶ SXM4

[SEEK]

Changes the seek mode.

- **SEEK1**: Skip to another available channel.
- **SEEK2**: Skip to another preset channel.

[CH▼]/[CH▲]

Selects the channel.

[MENU]

Displays the **<TOP MENU>** screen.

SiriusXM® Satellite RADIO

❑ Changing the display information



The preset list containing the channel names is displayed.

- Press **[TEXT]** again to display the text information for the station currently being received.

Presetting channels

❑ Storing channels in the memory

You can preset 6 channels for each band.

- 1 Tune in to a channel you want to preset. (Page 27)
- 2 Select a preset number.



The channel selected in step 1 is stored.

❑ Selecting a preset channel



Selecting a channel

❑ Selecting a channel on the list

You can obtain information on channels or select a category and then a channel.

- 1 Display the **<List Type Select>** screen.



- 2 Select the list type.



<Preset List>

Selects from the preset list.

- To preset the channels, see the left column.

<Channel List>

Selects from the channel names (Channel List).

- 3 Select a channel.

On the **<Preset List>** screen

Select a band (1), and then select a preset channel (2).



On the **<Channel List>** screen

Select a category (1), and then select a channel (2).



- You can change the page to display more items by pressing **[▲]/[▼]**.
- To list all the channels, select **[All Channels]**.



- Pressing the info change button above the list displays information in the following order: Channel Name, Artist Name, Song Title, Content Info.



SiriusXM® Satellite RADIO

Replay

You can pause, rewind and replay content from the currently tuned channel.

- The SiriusXM Connect Vehicle Tuner continually buffers up to 60 minutes of audio.
- If you change to another channel during playback, the Replay buffer content will be lost.

Indications on the source control screen



1 Playback status

2 Progress bar

Shows the remaining capacity (gray) and the amount of buffered content (blue). If the Replay buffer is full, the entire bar is indicated in blue.

- Updated every second.

3 Time code

Shows you the point in the Replay buffer you are listening to.

- Example: -5:00
 - You are listening to audio that is 5 minutes behind the current broadcast.
- Updated every second.

Replaying content



- To pause the playback, press **[▶||]**.
- To skip the current track/segment, press **[◀◀|]**/**[▶▶]**.
 - Pressing **[◀◀|]** within 2 seconds of the beginning of the current track/segment returns to the previous track.
 - Pressing **[◀◀|]** after 2 seconds or more of the track have been replayed returns to the beginning of the current track/segment.
- To rewind/fast forward, press and hold **[◀◀|]**/**[▶▶]**.
- To return to the live position, press **[Live]**.

SmartFavorites

User stored channels (P1 to P6) are recognized as SmartFavorites channels. SiriusXM Connect Vehicle Tuner automatically buffers their broadcast content in the background. When you select a SmartFavorite channel, you can rewind and replay up to 30 minutes of any of the missed news, talk, sports or music content.

- SmartFavorites is available only when you connect a SXV200 or later Sirius XM Connect Vehicle Tuner.
- If you change band, the buffered contents are cleared.

TuneStart™

When you select a preset channel, you can listen to the song from the beginning.

Activating TuneStart™

1

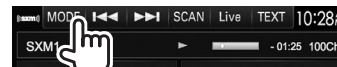

2



To deactivate TuneStart: Select **[OFF]** for **<Tune Start>**.

SiriusXM® Satellite RADIO

TuneScan™

You can check the buffered contents by scanning the first 6 seconds of the buffered contents of the preset channels and the currently tuned channel.

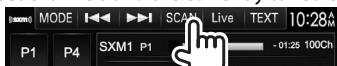

The unit starts scanning.

- To select the previous/next content, press [◀] or [▶].
- To finish scanning and continue playing contents, press [SCAN].
- To exit scanning, press and hold [SCAN].

Setting reception restrictions

Setting the parental control

You can set the parental control in order to, for example, restrict children from receiving adult channels.

Setting/Changing the parental code

- The initial setting is "0000."
- Changing the code does not change the <Parental Control>/<Parental Lock Channel> settings.

- 1 Display the <Parental Code Check> screen.

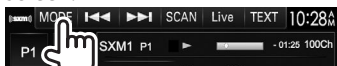

- 2 Enter a four-digit code (①), and then confirm (②).

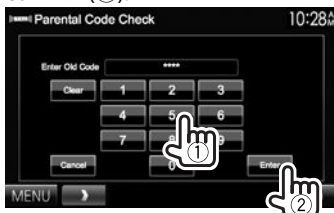

- To clear the entry, press [Clear].
- To cancel setting the code, press [Cancel].

- 3 Enter a new four-digit code (①), and then confirm (②).

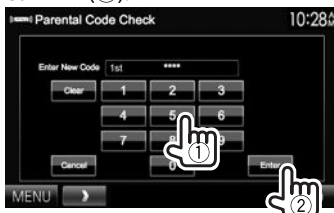

- To clear the entry, press [Clear].
- To cancel setting the code, press [Cancel].

- 4 Enter the four-digit code and then press [Enter] again to confirm the code.

Activating/Deactivating the parental control

You can set the parental control for all channels classified as "mature" by SiriusXM® or for selected channels by user.



- [OFF] Deactivates the parental mature and user lock.
- [Mature] Activates the parental mature control.
- [User] Locks only the selected channels.

- 3 Enter the parental code to confirm your choice.

SiriusXM® Satellite RADIO

Selecting the channels to lock—Parental Lock Channel

This parental control option allows you to pick the channels to be locked by the parental control feature.

- When <Parental Control> is set to [Mature] or [OFF], you cannot change the <Parental Lock Channel> setting.



2 Enter the parental code.

3 Select a category (①), and then a channel (②).



- You can change the page to display more items by pressing [▲]/[▼].
- To list all the channels, select [All Channels].
- A checkmark appears beside the selected channel.

Repeat this step if you want to set the lock on multiple channels.

To deactivate the parental lock for all locked channels: Select [All Clear] for <Parental Lock Channel> on the <SiriusXM Mode> screen, then enter the parental code number.

☐ Skipping unwanted channels

If you do not want to receive some channels, you can skip them.

Activating the channel skipping

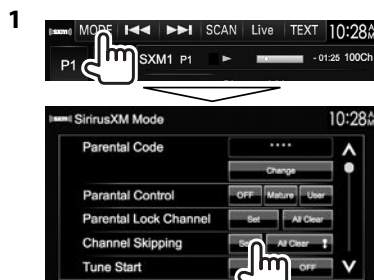

2 Select a category (①), and then select a channel (②).

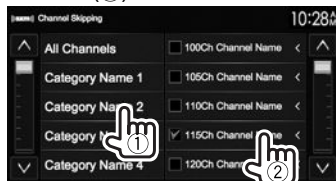

- You can change the page to display more items by pressing [▲]/[▼].
- To list all the channels, select [All Channels].
- A checkmark appears beside the selected channel.

Repeat this step if you want to skip multiple channels.

To clear the channel skipping for all skipped channels: Press and hold [All Clear] in <Channel Skipping> on the <SiriusXM Mode> screen.

☐ Resetting the SiriusXM Satellite Radio settings

You can reset the SiriusXM Satellite Radio settings you made and restore the default settings.

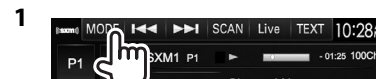

- Press [▼] repeatedly to change the page on the <SiriusXM Mode> screen.



OTHER EXTERNAL COMPONENTS

Using external audio/video players—AV-IN

When the operation buttons are not displayed on the screen, touch the area shown on the illustration.

- To change settings for video playback, see page 43.

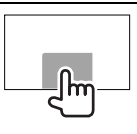

You can connect an external component to the Audio Video input terminal* and iPod/Audio Video input terminal. (Page 56)

* Only for DDX415BT/DDX315.

Preparation

Select an appropriate input setting for <AV Input>.

- Only for DDX415BT/DDX315: Perform the following setting when using “AV-IN2”. No preparation is required for “AV-IN1”.
- You can change the setting only when [STANDBY] is selected on <TOP MENU>. (Page 8)

- Display the <Input> setting screen. On the <TOP MENU> screen:

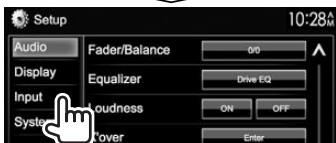

2



- For DDX672BH/DDX492/DDX392/DDX372BT/DDX320BT/DDX272: Select [AV-IN].
- For DDX415BT/DDX315: Select [AV-IN2].

Indications and buttons on the source control screen



Playback information

- AV-IN name

Operation buttons

- [MODE] Changes the AV-IN name.
- Press [◀] or [▶] to select an AV-IN name.
 - This setting does not affect the source name displayed on <TOP MENU>.
- [MENU] Displays the <TOP MENU> screen.

Starting playback

- Connect an external component. (Page 56)
- For DDX415BT/DDX315: Select “AV-IN1” or “AV-IN2” as the source. On the <TOP MENU> screen:



For DDX672BH/DDX492/DDX392/DDX372BT/DDX320BT/DDX272: Select “AV-IN” as the source.

On the <TOP MENU> screen:



- Turn on the connected component and start playing the source.

OTHER EXTERNAL COMPONENTS

Using a rear view camera

- To connect a rear view camera, see page 56.
- To use a rear view camera, a REVERSE lead connection is required. (Page 55)

Activating the rear view camera

- 1 Display the <Input> setting screen.
On the <TOP MENU> screen:

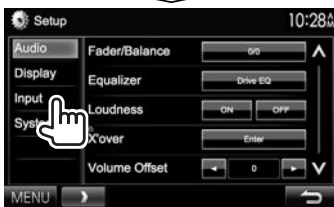

2

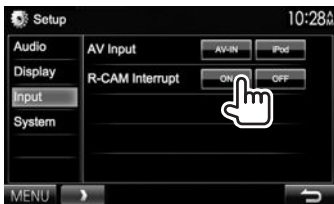

To deactivate: Select [Off] for <R-CAM Interrupt>.

Displaying the picture from the rear view camera

The rear view screen is displayed when you shift the gear to the reverse (R) position.

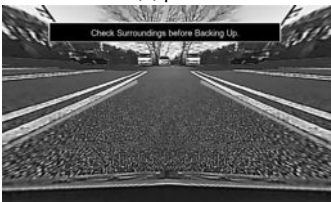

- To erase the caution message, touch the screen.
- You can change the setting of the picture using [Zoom]/[Aspect]/[Picture Adjust]. (Page 43)

To display the picture from the rear view camera manually

- This operation works only when <AV Key Long Press> is set to [R-CAM]. (Page 50)

DDX672BH

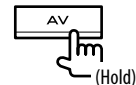

**DDX492/DDX392/DDX372BT/
DDX320BT/DDX272**

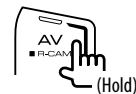

DDX415BT/DDX315



To exit the rear view screen: Press and hold the same button again.

Information for using Bluetooth® devices



Bluetooth is a short-range wireless radio communication technology for mobile devices such as mobile phones, portable PCs, and other devices. Bluetooth devices can be connected without cables and communicate with each other.

Notes

- While driving, do not perform complicated operations such as dialing numbers, using the phonebook, etc. When you perform these operations, stop your car in a safe place.
- Some Bluetooth devices may not connect to this unit depending on the Bluetooth version of the device.
- This unit may not work for some Bluetooth devices.
- Connecting conditions may vary depending on your environment.
- For some Bluetooth devices, the device is disconnected when the unit is turned off.

Connecting Bluetooth devices

❑ Registering a new Bluetooth device

When you connect a Bluetooth device to the unit for the first time, pair the unit and the device. Pairing allows Bluetooth devices to communicate with each other.

- The pairing method differs depending on the Bluetooth version of the device.
 - For devices with Bluetooth 2.1: You can pair the device and the unit using SSP (Secure Simple Pairing) which only requires confirmation.
 - For devices with Bluetooth 2.0: You need to enter a PIN code both on the device and unit for pairing.
- Once the connection is established, it is registered in the unit even if you reset the unit. Up to 5 devices can be registered in total.
- Only one device for Bluetooth phone and one for Bluetooth audio can be connected at a time.
- To use the Bluetooth function, you need to turn on the Bluetooth function of the device.
- To use the registered device, you need to connect the device to the unit. (Page 36)

Auto pairing

When <Auto Pairing> is set to [ON], iOS device (such as iPhone) is automatically paired when connected via USB. (Page 50)

Pairing a Bluetooth device using SSP (for Bluetooth 2.1)

When the Bluetooth device is compatible with Bluetooth 2.1, a pairing request is sent from an available device.

- 1 Search the unit (“**DDX ******”) from your Bluetooth device.
- 2 Confirm the request both on the device and the unit.



- Press [Cancel] to reject the request.

BLUETOOTH

Pairing a Bluetooth device using a PIN code (for Bluetooth 2.0)

- 1 Display the **<Bluetooth Setup>** screen.
On the **<TOP MENU>** screen:
 - Press [**▼**] repeatedly to change the page on the **<System>** menu screen.



- 2 Change the PIN code.
 - If you skip changing the PIN code, go to step 3.
 - The PIN code is initially set to "0000".
 - The maximum number of digits in the PIN code is 16.

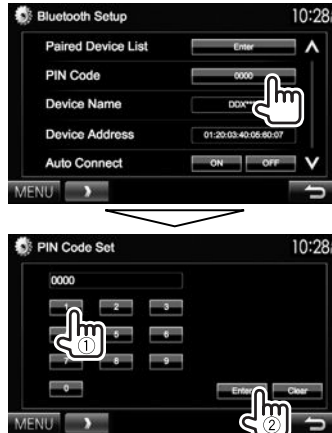

- Press [**Clear**] to delete the last entry.
- 3 Search the unit ("**DDX *******") from your Bluetooth device.

- 4 Select the unit ("**DDX *******") for your Bluetooth device.



- If the PIN code is required, enter "0000" (initial).

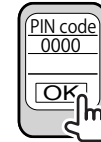

When pairing is complete, the device is listed on **<Paired Device List>**.



- To use the paired device, connect the device on **<Paired Device List>**. (Page 36)

BLUETOOTH

❑ Connecting a registered Bluetooth device

1 Display the <Bluetooth Setup> screen.
(Page 35)



3 Select the device you want to connect (①), then select what you want to use the device for (②).



[TEL (HFP)]: for mobile phone

[Audio (A2DP)]: for Bluetooth audio player

[PANDORA (SPP)]: for Pandora*

- Selectable items depend on the device you are operating.
- If you connect a device while another device is connected, the device previously connected is disconnected and the connection for the newly connected device is established.

- When a Bluetooth mobile phone is connected, the signal strength and battery level are displayed when the information is acquired from the device.

To disconnect

Select [TEL (HFP)], [Audio (A2DP)], or [PANDORA (SPP)]* to disconnect the Bluetooth device being used for that function on the <Paired Device List> screen (see the left column).

* [PANDORA (SPP)] appears only for DDX672BH/DDX492/DDX392/DDX372BT/DDX320BT.

❑ Deleting a registered Bluetooth device

1 Display the <Bluetooth Setup> screen.
(Page 35)



3 Select a device to delete (①), then delete the registration (②).



A confirmation message appears. Press [Yes].

* [PANDORA (SPP)] appears only for DDX672BH/DDX492/DDX392/DDX372BT/DDX320BT.

Using the Bluetooth mobile phone

❑ Receiving a call

When a call comes in...

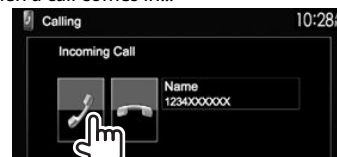

- Call information is displayed if acquired.
- Phone operation is not available while the picture from the rear view camera is displayed.
(Page 33)

To reject a call

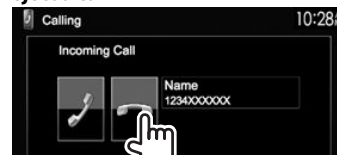

When <Auto Response> is set to [ON] (Page 41)
The unit answers the incoming call automatically.

❑ Ending a call

While talking...



BLUETOOTH

❑ Adjusting the volume of calls/earpiece/microphone

While talking...



- You can adjust the volume level between -20 to +8 (initial: 0).
- Use the monitor panel to adjust the call/earpiece volume. (Page 7)

❑ Switching between handsfree mode and phone mode

While talking...



Each time you press the button, the talking method is switched (: handsfree mode / : phone mode).

❑ Notification when SMS is received

If the mobile phone is compatible with SMS (Short Message Service), the unit tells you a message has been received when **<SMS Notify>** is set to **[ON]**. (Page 41)

- To read a received message, operate the mobile phone after stopping the car in a safe place.
 - You cannot read, edit, or send a message through the unit.
- For some mobile phones, the notification message may not be shown even if the SMS function is supported.

❑ Reducing noise/adjusting the echo cancel level

While talking...



- **To adjust the echo volume (between 1 to 10, initial: 4):** Adjust **<EC LEVEL>**.
- **To adjust the noise reduction volume (between -5 to -20, initial: -7) :** Adjust **<NR LEVEL>**.

❑ Making a call

- 1 Display the **<Hands Free>** screen. On the **<TOP MENU>** screen:



- You can also display the **<Hands Free>** screen by pressing TEL on the monitor panel.
- 2 Select a method to make a call.



- 1 From the phone book/call lists
- 2 Direct number entry
- 3 Voice dialing
- 4 Preset list
 - To preset, see page 39.

BLUETOOTH

From the phone book/call lists

1



[Outgoing] From the dialed call list

[Incoming] From the received call list

[Missed] From the missed call list

[Phonebook] From the phone book

- To copy the phone book, see page 39.

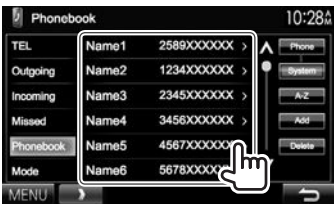

- You can change the page to display more items by pressing [▲]/[▼].

2



- To use the A to Z search in the phone book:
When the <Phonebook> screen is displayed, you can search by initial.

1



2 Select the initial.

- If the initial is not a letter or number, press **[Others]**.



3 Select a phone number from the list.

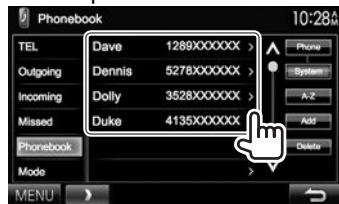

- To display the details of an entry:
When the <Phonebook> is displayed, you can display the details of an entry and select a phone number if several phone numbers are registered.

1 Display the details of the desired entry.



2 Select a phone number to call.

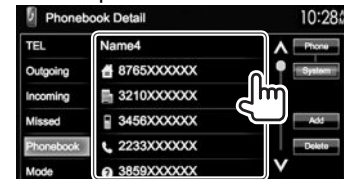

Direct number entry

You can enter up to 32 numbers.



- Press **[Clear]** to delete the last entry.
- Press and hold **[0+]** to add "+" to the phone number.
- Press **[Preset]** to save the entered phone number onto the preset list.

BLUETOOTH

Voice dialing

- Available only when the connected mobile phone has a voice recognition system.

- 1 Activate voice dialing.
On the **<Hands Free>** screen:



On the monitor panel:
DDX672BH

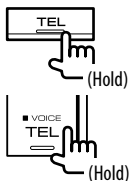

**DDX492/DDX415BT/
DDX392/DDX372BT/
DDX320BT**

- 2 Say the name of the person you want to call.
 - If the unit cannot find the target, the following screen appears. Press **[Start]**, then say the name again.



To cancel voice dialing: Press **[Cancel]**.

❑ Presetting phone numbers

You can preset up to 6 phone numbers.

- 1 Display the **<Hands Free>** screen.
(Page 37)
- 2 Select an item from the phone book/call lists. (Page 38)
- 3 Select a phone number.



- 4 Select a preset number to store into.



- You can also preset a phone number entered on the **<Direct Number>** screen by pressing **[Preset]**. (Page 38)

To delete the preset phone numbers: Initialize the settings from **<Initialize>** in **<Bluetooth Setup>**. (Page 50)

❑ Copying the phone book

You can copy the phone book memory of a mobile phone into the unit (up to 400 entries).

- 1 Display the **<Hands Free>** screen.
(Page 37)
- 2



3

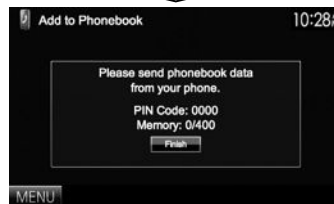
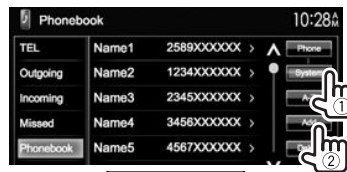

The PIN code (initial: 0000) necessary for copying the phonebook from the mobile phone and the number of copied phone book entries are displayed.

- 4 Operate the target mobile phone.
 - Refer to the instruction manual supplied with your mobile phone.
 - To cancel the transfer, press **[Finish]**.
- 5 Finish the procedure.



The phone book memory is copied from the mobile phone.

BLUETOOTH

About mobile phones compatible with Phone Book Access Profile (PBAP)

If your mobile phone supports PBAP, you can display the phone book and call lists on the touch panel screen when the mobile phone is connected.

- Phone book: up to 5 000 entries
- Dialed calls, received calls, and missed calls: up to 50 entries each

To display the phone book/call lists of the mobile phone or the unit

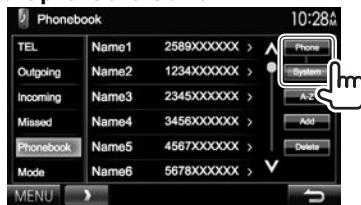

[Phone] Displays the phone book/call lists on the connected mobile phone.

[System] Displays the phone book/call lists copied to the unit.

❑ Deleting the phone number entries in the unit

- 1 Display the phone book/call list you want to delete. (Page 37)

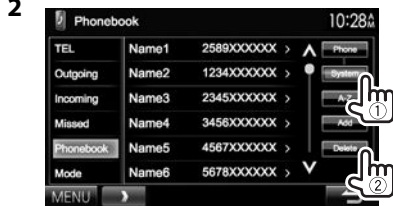

- You cannot delete data when **[Phone]** is selected.

- 3 Select the item you want to delete.

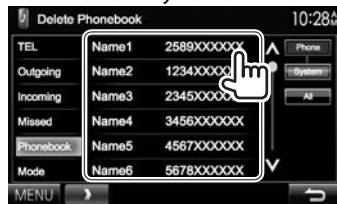

- Press **[All]** to delete all the numbers/names in the selected list.

A confirmation message appears. Press **[Yes]**.

Settings for Bluetooth mobile phones

- 1 Display the **<Hands Free>** screen. (Page 37)



BLUETOOTH

□ Setting items

<Phone Device>	Shows the connected phone device name.
<Auto Response>	<ul style="list-style-type: none"> • ON: The unit answers the incoming calls automatically in 5 seconds. • OFF (Initial): The unit does not answer the calls automatically. Answer the calls manually.
<SMS Notify>	<ul style="list-style-type: none"> • ON: The unit informs you of the arrival of a message by ringing and displaying "Receiving Message". • OFF (Initial): The unit does not inform you of the arrival of a message.
<Ring Mode>	<ul style="list-style-type: none"> • System (Initial): The ring tone set on the unit is used. • Phone: The ring tone set on the mobile phone is used. (This function may not work depending on the mobile phone.)
<Ring Tone Change>	<p>When <Ring Mode> is set to <System>, press [Enter], then select the ring tone for received calls and SMS from <Tone1> (Initial), <Tone2>, <Tone3>.</p> <ul style="list-style-type: none"> • Call Tone: Selects the ring tone for phone calls. • Message Tone: Selects the ring tone for SMS.

Using the Bluetooth audio player

- To register a new device, see page 34.
- To connect/disconnect a device, see page 36.

□ Indications and buttons on the source control screen



- The operation buttons, indications and information displayed on the screen differ depending on the connected device.

Playback information

- 1 Playback status*
- 2 Playing time*
- 3 Tag data (current track title/artist name/album title)*
 - Pressing [←] scrolls the text if not all of the text is shown.
- 4 The signal strength and battery level (only when the information is acquired from the device)

Operation buttons

- [|◀▶|] [▶▶▶]
- Selects a track. (Press)
 - Reverse/forward search.* (Hold)
- ▶▶▶
- [|||]
- [MENU]
- Starts playback.
 - Pauses playback.
 - Displays the <TOP MENU> screen.

* Available only for devices compatible with AVRCP 1.3.

SETTINGS

Sound adjustment

Using the sound equalization

- The adjustment is memorized for each source until you adjust the sound again. If the source is a disc, the adjustment is stored for each of the following categories.
 - DVD/VCD
 - CD
 - DivX/MPEG1/MPEG2/MP3/WMA/WAV/AAC
- You cannot adjust the sound when the unit is in standby.

Selecting a preset sound mode

1 Display the <Equalizer> screen.

On the <TOP MENU> screen:



2 Select a sound mode.

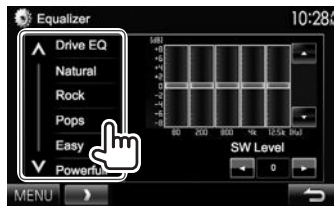

- You can change the page to display more items by pressing [▲]/[▼].
- [Drive EQ]** is a preset equalizer that reduces noise from the road.
- You can also display the <Equalizer> screen by pressing AUD (for DDX672BH/DDX415BT/DDX315/DDX272) or by pressing and holding the Volume/ATT/AUDIO knob (for DDX492/DDX392/DDX372BT/DDX320BT) on the monitor panel.

Storing your own adjustment—Customizing preset sound mode

- Select a sound mode. (See the far left column.)
- Select a band and adjust the level of the selected band.
 - You can adjust the level by dragging the control or using [▲]/[▼].
 - Repeat this step to adjust the level of other bands.

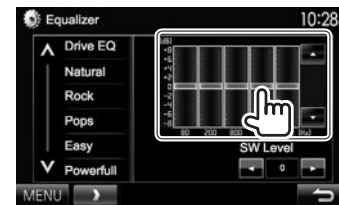

- Adjust the subwoofer level.
 - The subwoofer level is adjustable only when the subwoofer is activated. (Page 48)

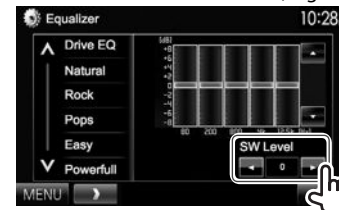

The adjustments are stored and <User> is activated.

SETTINGS

□ Adjusting the crossover frequency

1 Display the <X'over> screen.

On the <TOP MENU> screen:



- When <X'over> is grayed out, you cannot change the setting. Select [**Unlock**] on the <SETUP Memory> screen to change the setting. (Page 47)

2 Select the item to adjust (①), then make adjustments (②).

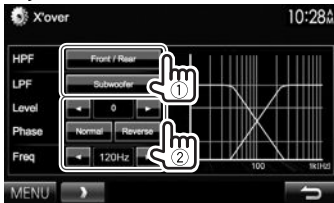

- <HPF> Adjusts the crossover for the front/rear speakers (high pass filter).
- <LPF> Adjusts the crossover for the subwoofer (low pass filter).*¹
- <Level> Adjusts the subwoofer level.*¹
- <Phase> Selects the phase for the subwoofer.*²
- <Freq> Adjusts the crossover frequency.

*¹ Adjustable only when the subwoofer is activated. (Page 48)

*² Not selectable when <Freq> is set to <Through>.

Adjustment for video playback

□ Adjusting the picture

You can adjust the picture quality.

1 Display the adjustment menu.

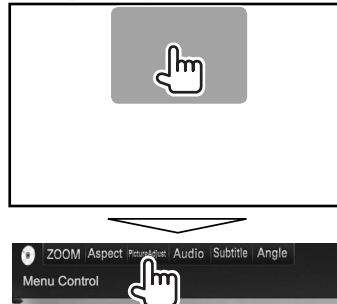

- When the App screen is displayed, you can press AV on the monitor panel to switch to the picture adjustment menu.

2 Select [**DIM ON**] (dimmer on) or [**DIM OFF**] (dimmer off).

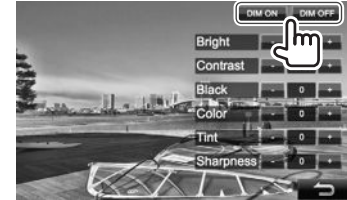

3 Adjust the picture (-15 to +15).



- <Bright> Adjusts the brightness.
- <Contrast> Adjusts the contrast.
- <Black> Adjusts the blackness.
- <Color> Adjusts the color.
- <Tint>* Adjusts the tint.
- <Sharpness> Adjusts the sharpness.

* Adjustable only when the incoming signal is NTSC.

SETTINGS

❑ Changing the aspect ratio

You can change the aspect ratio for video playback.

1 Display the adjustment menu.

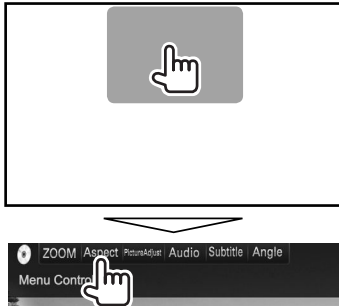

2 Select the aspect ratio.



<FULL>*

For 16:9 original pictures



<JUST>

For viewing 4:3 pictures naturally on the wide screen



<Normal>*

For 4:3 original pictures



<Auto>

For "DISC"/"USB" only: The aspect ratio is automatically selected to match the incoming signals.

* While DivX is played back with <Screen Ratio> set to [16:9] (for DVD: Page 14/for USB: Page 16), the aspect ratio is not set correctly.

❑ Zooming the picture

You can zoom the picture (<FULL>, <Zoom1> to <Zoom3>).

- When <Aspect> is set to <JUST> or <Auto> (see the left column), the picture is zoomed with the aspect ratio of the <FULL> setting.

1 Display the adjustment menu.

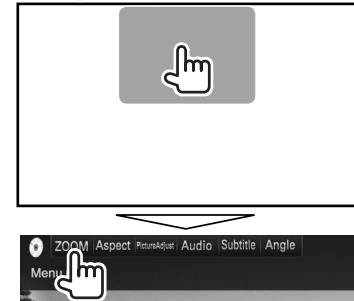

2 Change the magnification (①), then move the zooming frame (②).



- The zoom function cannot be used for some video sources.

SETTINGS

Changing display design

You can change the background and panel color.

1 Display the <User Customize> screen.

On the <TOP MENU> screen:

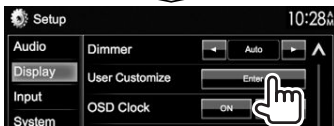

2 Select an item to change (background design: [**Background**]/panel color: [**Panel Color**]).



3 Select a background/panel color.
To select a background

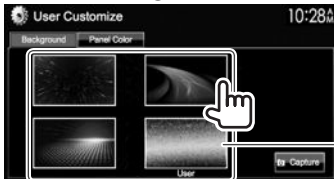

- The number of preset backgrounds and the designs available differ depending on the model.

To select a panel color

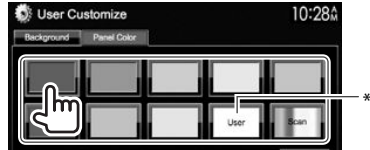

- Selecting [**Scan**] changes the illumination color gradually.

*1 Store your own scene beforehand. (See the right column.)

*2 Store your own color adjustment beforehand. (See below.)

❑ Making your own color adjustment

1 Select [**Panel Color**] on the <User Customize> screen. (See the left column.)



3 Select the dimmer setting for the color (①), then adjust the color (②).



❑ Storing your own scene for the background image

While playing a video or picture, you can capture an image and use the captured image as a background.

- You cannot capture copyrighted content and images from iPod/iPhone.
- When using a JPEG file as the background, make sure that the resolution is 800 x 480 pixels.
- The color of the captured image may look different from that of the actual scene.

1 Play a video or picture.

2 Display the <User Customize> screen. (See the far left column.)



4 Adjust the image.

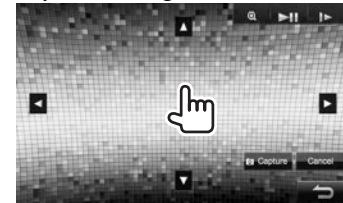

[▲][▼][◀][▶]

Moves the zooming frame.
Magnifies the scene. (<OFF>, <Zoom1> - <Zoom3>)

[🔍]

▶|||*

Starts/pauses playback.

[|▶]*

Advances scenes frame-by-frame.

- To cancel the capture, press [**Cancel**].

Continued to the next page...

SETTINGS

- 5 Capture the image displayed on the screen.

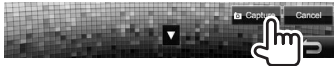

A confirmation message appears. Press **[Yes]** to store the newly captured image. (The existing image is replaced with the new one.)

- Press **[No]** to return to the previous screen.

* Not displayed when playing an external component connected to the Audio Video input or iPod/Audio Video input terminal.

- 2 Select where to place the icon (①), then select the item you want to display in the selected position (②).



Repeat this step to place icons for other items.

- 2

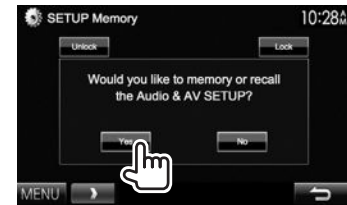

- To cancel, press **[No]**.

- 3 Select an operation.



- [Recall]** Recalls the memorized settings.
- [Memory]** Memorizes the current settings.
- [Clear]** Clears the currently memorized settings.

- To cancel, press **[Cancel]**.

A confirmation message appears. Press **[Yes]**.

- When you perform recall or clear, the unit enters standby mode after confirmation.

Customizing the <TOP MENU> screen

You can arrange the items to display on the <TOP MENU> screen.

- 1 Display the <Menu Customize> screen. On the <TOP MENU> screen:
- Press **[V]** repeatedly to change the page on the <Display> menu screen.

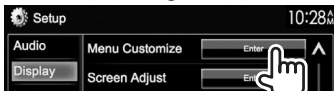
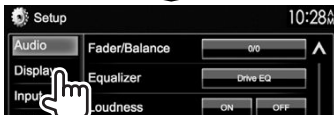

Customizing the system settings

Memorizing/recalling the settings

- You can memorize the settings changed in the <Setup> menu and recall the memorized settings anytime.
- The memorized settings are kept even when the unit is reset. (Page 3)

- 1 Display the <SETUP Memory> screen. On the <TOP MENU> screen:

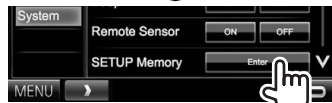

SETTINGS

❑ Locking the settings

You can lock the settings to prevent them from being changed.

- A  icon is shown beside the settings that can be locked.

1 Display the **<SETUP Memory>** screen.
(Page 46)

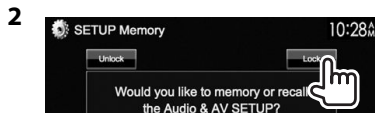

To unlock the setting: Press [Unlock].

❑ Updating the system

You can update the system by connecting a USB device containing an update file.

- For system updates, visit <http://www.kenwood.com/cs/ce/>.

1 Create an update file, copy it to a USB device, and connect it to the unit.

- To connect a USB device, see page 56.

2 Display the **<System Information>** screen.

On the **<TOP MENU>** screen:

- Press [▼] repeatedly to change the page on the **<System>** menu screen.

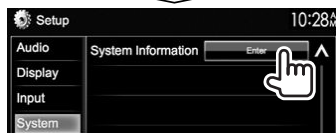

3

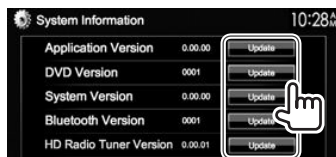

<Application Version>

Updates the system application.

<DVD Version>

Updates the DVD system application.

<System Version>

Updates the system.

<Bluetooth Version>*1

Updates the Bluetooth application.

<HD Radio Tuner Version>*2

Updates the HD Radio module application.

It may take a while.

If the update has been completed successfully, "Update Completed" appears. Reset the unit.

- If the update has failed, turn the power off and then on, and retry the update.
- Even if you have turned off the power during the update, you can restart the update after the power is turned on. The update will be performed from the beginning.

* Only for DDX672BH/DDX492/DDX415BT/DDX392/DDX372BT/DDX320BT.

*2 Only for DDX672BH/DDX492.

❑ Adjusting the touch position

You can adjust the touch position on the touch panel if the position touched and the operation performed do not match.

1 Display the **<Touch Panel Adjust>** screen. On the **<TOP MENU>** screen:

- Press [▼] repeatedly to change the page on the **<System>** menu screen.



2 Touch the center of the marks at the lower left and at the upper right as instructed.

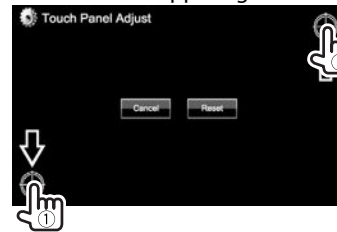

- To reset the touch position, press [Reset].
- To cancel the current operation, press [Cancel].

SETTINGS

Setting menu items

□ **Displaying the <Setup> menu screen**

On the <TOP MENU> screen:



- You cannot change the <Audio> settings screen when [STANDBY] is selected on the <TOP MENU> screen. (Page 8)

□ **<Audio> setting screen**

<Fader/Balance>

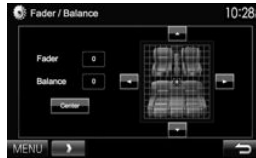

Fader: Adjust the front and rear speaker output balance.

- **F6 to R6** (Initial: **0**)
 - When using a two-speaker system, set the fader to the center (**0**).

Balance: Adjust the left and right speaker output balance.

- **L6 to R6** (Initial: **0**)
 - Press [▲]/[▼]/[◀]/[▶] or drag [5/5] to adjust.
 - To clear the adjustment, press [**Center**].

<Equalizer>

Change the sound mode or adjust and store the equalization for each source. (Page 42)

- **Drive EQ** (Initial)/**Natural/Rock/Pops/Easy/Powerful/Top40/Jazz/User**

<Loudness>

You can activate/deactivate loudness.

- **ON** (Initial): Boost low and high frequencies to produce a well-balanced sound at a low volume level. The LOUD indicator lights up.
- **OFF:** Cancels.

<X'over>*

Adjust the crossover frequency. (Page 43)

<Volume Offset>

Adjust and store the auto-adjustment volume level for each source. (For discs, the adjustment volume is stored for each of the following categories: DVD/VCD, CD, and DivX/MPEG1/MPEG2/MP3/WMA/WAV/AAC.) The volume level will automatically increase or decrease when you change the source.

- **-15 to +6** (Initial: **0**)

<Subwoofer>*

- **ON** (Initial): Activates the subwoofer.
- **OFF:** Deactivates the subwoofer.

<Bass Boost>

Select your preferred bass boost level.

- **OFF** (Initial)/**Level 1/Level 2/Level 3**

<Speaker Select>*

Select the size of the connected speaker.

- **Standard** (Initial)/**Narrow/Middle/Wide**

* When an item is grayed out, you cannot change the setting. Select [**Unlock**] on the <SETUP Memory> screen to change the setting. (Page 47)

SETTINGS

□ <Display> setting screen

<Dimmer>

- **Auto** (Initial): Dims the screen and button illumination when you turn on the headlights.
 - The ILLUMI lead connection is required. (Page 55)
- **ON**: Activates dimmer.
- **OFF**: Cancels.

<User Customize>

Change the display design (background and panel color). (Page 45)

<OSD Clock>

- **ON**: Displays the clock while a video source is played back.
- **OFF** (Initial): Cancels.

<Demonstration>

- **ON** (Initial): Activates the demonstration on the screen.
- **OFF**: Cancels.

<Scroll>

- **ON** (Initial): Repeats scrolling.
 - **Once**: Scrolls the displayed information once.
 - **OFF**: Cancels.
- Pressing [**<**] scrolls the text regardless of this setting.

<Menu Customize>

Change the items to display on the <TOP MENU> screen. (Page 46)

<Screen Adjust>

Adjust the brightness and blackness of the screen. Press [**Enter**] to display the setting screen, select [**DIM ON**] (dimmer on)/[**DIM OFF**] (dimmer off), then change the following settings:

- **Bright**: Adjusts brightness.
 - **-15** to **+15** (Initial: **0** for Dimmer On/**+15** for Dimmer Off)
- **Black**: Adjusts blackness.
 - **-15** to **+15** (Initial: **0**)

<Video Output>*1

Select the color system of the external monitor.

- **NTSC** (Initial), **PAL**

<Angle>*2

Adjust the panel angle. (Page 8)

*1 "Please Power Off" appears when the setting is changed. Turn off the power, then turn on to enable the change.

*2 Only for DDX672BH.

□ <Input> setting screen

<AV Input>

You can determine the use of the iPod/Audio Video input terminal.

- **AV-IN** (Initial)*1: Select to use the AV component connected to the iPod/AV-IN input terminal. (Page 56)
- **AV-IN2** (Initial)*2: Select to use the AV component connected to the iPod/AV-IN2 input terminal. (Page 56)
- **iPod**: Select to use iPod/iPhone connected using the USB Audio/Video cable for iPod/iPhone. (Page 56)

<R-CAM Interrupt>

- **ON**: Displays the picture from the rear view camera when you shift the gear to the reverse (R) position.
- **OFF** (Initial): Select this when no camera is connected.

*1 Only for DDX672BH/DDX492/DDX392/DDX372BT/DDX320BT/DDX272.

*2 Only for DDX415BT/DDX315.

SETTINGS

<System> setting screen

<Language>*1

Select the text language used for on-screen information.

- **English** (Initial)/**Español/Français/Deutsch/Italiano/Nederlands/Ελληνικά/Português/Türkçe/Čeština/Polski/Magyar/Русский/עברית/العربية/فارسی/தமிழ்/ไทย/简体中文/繁體中文/Bahasa Indonesia/한국어**
 - For external monitors, only English/Spanish/French/German/Italian/Dutch/Russian/Portuguese are available. If another language has been selected, the text language for external monitors will be set to English.
- **GUI Language**: Select a language used for displaying operation buttons and menu items.
 - **English** (Initial)/**Local** (the language selected above)

<Clock>

Adjust the clock time. (Page 5)

<Beep>

- **ON** (Initial): Activates the key-touch tone.
- **OFF**: Cancels.

<Remote Sensor>

- **ON** (Initial): Activates the remote sensor.
- **OFF**: Cancels.

<SETUP Memory>

You can memorize, recall, or clear the settings you have made. (Page 46)

<Bluetooth Setup>*2

Configure settings for using a Bluetooth device, such as connection and other general operations.

- **Paired Device List**: Press **[Enter]** to show the list of registered devices. You can connect the device or delete the registration. (Page 36)
- **PIN Code**: Changes the PIN code of the unit. (Page 35)
- **Device Name**: Shows the device name to be shown on the Bluetooth device—"DDX****".
- **Device Address**: Shows the device address of the unit.
- **Auto Connect**:
 - **ON** (Initial): The connection is automatically established with the last connected Bluetooth device when the unit is turned on.
 - **OFF**: Cancels.
- **Bluetooth HF/Audio**: Select the speakers used for Bluetooth (both phone and audio player).
 - **Front Only**: From front speakers only.
 - **All** (Initial): From all speakers.
- **Auto Pairing**:
 - **ON** (initial): Establishes pairing automatically with the connected iOS device (such as iPhone) even if the Bluetooth function is deactivated on the device. (Auto pairing may not work for some devices depending on the iOS version.)
 - **OFF**: Cancels.
- **Initialize**: Hold **[Enter]** to initialize all settings you have made for using Bluetooth mobile phone and Bluetooth audio player.

<AV Key Long Press>

Assigns the function of the AV button when held.

- **V-OFF** (Initial for DDX415BT/DDX315): Turns off the screen. (Page 8)
- **APPs**: Displays the APPs screen.*3 (Page 19)
- **R-CAM** (Initial for DDX672BH/DDX492/DDX392/DDX372BT/DDX320BT/DDX272): Displays the picture from the rear view camera. (Page 33)

<DivX® VOD>*4

This unit has its own Registration Code. Once you have played back a file with the Registration Code recorded, this unit's Registration Code is overwritten for copyright protection.

- Press **[Enter]** to display the information.
- To return to the previous screen, press **[OK]**.

<Security Code>*4

Register the security code for the unit. (Page 4)

<SI>

Activate or deactivate the security function. (Page 5)

<Serial Number>*5

Displays the serial number.

<Touch Panel Adjust>

Adjust the touch position of the buttons on the screen. (Page 47)

<Steering Remote Controller>*4

Assign the functions to the keys on the remote controller of the steering wheel. (Contact your Kenwood dealer for details.)

<System Information>

Displays the version information of the software. You can update the software. (Page 47)

*1 "Please Power Off" appears when the setting is changed. Turn off the power, then turn on to enable the change.

*2 Only for DDX672BH/DDX492/DDX415BT/DDX392/DDX372BT/DDX320BT.

*3 Only displays the APPs screen when <AV Input> is set to **[iPod]** (Page 17).

*4 Only for DDX415BT/DDX315.

*5 Only for DDX672BH/DDX492/DDX392/DDX372BT/DDX320BT/DDX272.

REMOTE CONTROLLER

Overview

DDX415BT/DDX315:

This unit can be operated using the Remote Controller (RC-DV340) supplied with this unit.

DDX672BH/DDX492/DDX392/DDX372BT/

DDX320BT/DDX272:

Optional Remote Controller KNA-RCDV331 is designed for controlling this unit. Refer to the instruction manual that comes with the remote controller.

⚠ Caution:

- Put the Remote Controller in a place where it will not move during braking or other operations. A dangerous situation could result if the Remote Controller falls down and gets wedged under the pedals while driving.
- Do not leave the battery near fire or under direct sunlight. A fire, explosion or excessive heat generation may result.
- Do not recharge, short, break up or heat the battery or place it in an open fire. Such actions may cause the battery to leak fluid. If spilled fluid comes in contact with your eyes or on clothing, immediately rinse with water and consult a physician.
- Place the battery out of reach of children. In the unlikely event that a child swallows the battery, immediately consult a physician.

❑ Battery installation

Use two "AAA"/"R03"-size batteries.

Insert the batteries with the + and - poles aligned properly, following the illustration inside the case.

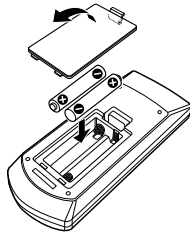

- If the Remote Controller operates only over shorter distances or does not operate at all, it is possible that the batteries are depleted. In such instances, replace both batteries with new ones.

❑ Remote Controller mode switch

The functions operated from the remote controller differ depending on the position of the mode switch.

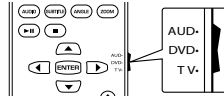

AUD mode: Switch to this mode when controlling a selected source or tuner source, etc.

DVD mode: Switch to this mode when playing DVDs or CDs etc. with the player integrated in this unit.

TV mode: Not used.

- The position of the remote control mode switch is indicated in the title of each mode, e.g., "AUD mode".
- When controlling a player that is not integrated in the unit, select "AUD" mode.

Operations from the remote controller

❑ Common operations (AUD mode)

SRC	<ul style="list-style-type: none">• Selects the source.• Hangs up the incoming/current call.
▲/▼ VOL	Adjusts the volume level.
ATT	Attenuates/restores the sound.
DISP/V.SEL	Does not function for this unit.
ENTER	Enters options.
☎	Answers incoming calls.*1
FNC/PBC/MENU	Switches the control screen.
MODE/TOP MENU	Changes the aspect ratio. <ul style="list-style-type: none">• Aspect ratio changes each time you press this key.
OPEN	Adjusts the panel angle.*2 <ul style="list-style-type: none">• The panel angle changes each time you press this key.

*1 Available for DDX672BH/DDX492/DDX415BT/DDX372/DDX320BT only.

*2 Available for DDX672BH only.

REMOTE CONTROLLER

❑ DVD/VCD (DVD mode)

	Moves the cursor when displaying a menu.
	Selects a track.
	Starts/pauses playback.
	Stops and memorizes the point where the disc stops.
0 – 9	<ul style="list-style-type: none"> Specifies the number to search for in direct search. : Fast forwards/backwards. <ul style="list-style-type: none"> – Fast forward/backward speed changes each time you press this key. : Slow forwards/backwards during pause.
MODE/TOP MENU	Shows the disc top menu.
FNC/PBC/MENU	Shows the disc menu.
SUBTITLE	Changes the subtitle language.
ZOOM	Changes the zoom ratio. <ul style="list-style-type: none"> Zoom ratio changes each time you press this key.
ANGLE	Changes the picture angle. <ul style="list-style-type: none"> Picture angle changes each time you press this key.
AUDIO	Changes the voice language. <ul style="list-style-type: none"> Voice language changes each time you press this key.
DIRECT	Enters direct search mode. (See the far right column.)
CLEAR	Deletes a character while in direct search mode.

❑ Music Disc/Audio file/Video file/Picture file (AUD mode)

AM –/FM +	Selects a folder.
	Selects a track/file.
	Starts/pauses playback.
0 – 9	Specifies the number to search for in direct search.
DIRECT	Enters direct search mode. (See the right column.)

❑ Radio/HD Radio*1/SiriusXM*2 (AUD mode)

AM –/FM +	Selects the band.
	Searches for stations.
	Changes the seek mode (AUTO1, AUTO2, MANU).
0 – 9	<ul style="list-style-type: none"> Specifies preset number. (–) Specifies the frequency of the station to receive to search for in direct search.
DIRECT	Enters direct search mode. (See the right column.)

*1 Only for DDX672BH/DDX492.

*2 Only for DDX672BH/DDX492/DDX392/DDX372BT/DDX320BT/DDX272.

❑ iPod (AUD mode)

	Selects music/videos.
	Starts/pauses playback.

❑ USB (AUD mode)

AM –/FM +	Selects a folder.
	Selects a file.
	Starts/pauses playback.

Searching for an item (chapter/title/folder/file/track) directly

- Press DIRECT to enter the search mode. Each time you press DIRECT, the item to search for changes.
- Press a number button to select a desired item.
- Press ENTER to confirm the selection.

Searching for a tuner frequency directly

- Press DIRECT to enter the search mode.
- Press number buttons to enter a frequency.
- Press ENTER to confirm the entry.

CONNECTION/INSTALLATION

Before installing the unit

⚠ WARNING

- If you connect the ignition wire (red) and the battery wire (yellow) to the car chassis (ground), you may cause a short circuit, that in turn may start a fire. Always connect those wires to the power source running through the fuse box.
- Do not cut out the fuse from the ignition wire (red) and the battery wire (yellow). The power supply must be connected to the wires via the fuse.

⚠ Precautions on installation and connection

- Mounting and wiring this product requires skills and experience. For best safety, leave the mounting and wiring work to professionals.
- Make sure to ground the unit to a negative 12 V DC power supply.
- Do not install the unit in a spot exposed to direct sunlight or excessive heat or humidity. Also avoid places with too much dust or the possibility of water splashing.
- Do not use your own screws. Use only the screws provided. If you use the wrong screws, you could damage the unit.
- If the power is not turned on ("Miswiring DC Offset Error", "Warning DC Offset Error" is displayed), the speaker wire may have a short circuit or have touched the chassis of the vehicle and the protection function may have been activated. Therefore, the speaker wire should be checked.

- If your car's ignition does not have an ACC position, connect the ignition wires to a power source that can be turned on and off with the ignition key. If you connect the ignition wire to a power source with a constant voltage supply, such as with battery wires, the battery may be drained.
- Only for DDX672BH:
If the console has a lid, make sure to install the unit so that the monitor panel will not hit the lid when closing and opening.
- If the fuse blows, first make sure the wires are not touching to cause a short circuit, then replace the old fuse with one with the same rating.
- Insulate unconnected wires with vinyl tape or other similar material. To prevent a short circuit, do not remove the caps on the ends of the unconnected wires or the terminals.
- Connect the speaker wires correctly to the terminals to which they correspond. The unit may be damaged or fail to work if you share the ⊖ wires or ground them to any metal part in the car.
- When only two speakers are being connected to the system, connect both connectors either to the front output terminals or to the rear output terminals (do not mix front and rear). For example, if you connect the ⊕ connector of the left speaker to a front output terminal, do not connect the ⊖ connector to a rear output terminal.
- After the unit is installed, check whether the brake lamps, blinkers, wipers, etc. on the car are working properly.
- Mount the unit so that the mounting angle is 30° or less.
- Do not press hard on the panel surface when installing the unit to the vehicle. Otherwise scars, damage, or failure may result.

⚠ CAUTION

Install this unit in the console of your vehicle. Do not touch the metal part of this unit during and shortly after the use of the unit. Metal parts such as the heat sink and enclosure become hot.

▣ Supplied accessories for installation

- ① Wiring harness x 1
- ② Trim plate x 1
- ③ Extension wire (2 m) x 1
- ④ Extraction keys x 2 *1
- ⑤ Flat head screws (M5 x 8 mm) x 6
- ⑥ Round head screws (M5 x 8 mm) x 6
- ⑦ Microphone (3 m) x 1 *2

*1 Only for DDX672BH/DDX492/DDX392/DDX372BT/DDX320BT/DDX272.

*2 Only for DDX672BH/DDX492/DDX415BT/DDX392/DDX372BT/DDX320BT.

CONNECTION/INSTALLATION

❑ Installation procedure

- 1 To prevent a short circuit, remove the key from the ignition and disconnect the \ominus battery.
- 2 Make the proper input and output wire connections for each unit.
- 3 Connect the speaker wires of the wiring harness.
- 4 Connect the wiring harness wires in the following order: ground, battery, ignition.
- 5 Connect the wiring harness connector to the unit.
- 6 Install the unit in your car.
 - Make sure that the unit is installed securely in place. If the unit is unstable, it may malfunction (eg, the sound may skip).
- 7 Reconnect the \ominus battery.
- 8 Press the reset button.
- 9 Configure **<Initial Setup>**. (Page 4)

Installing the unit

- ❑ **Installing the unit (only for DDX672BH/ DDX492/DDX392/DDX372BT/ DDX320BT/DDX272)**

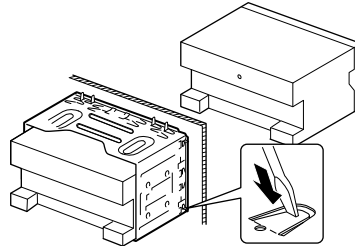

- Bend the tabs of the mounting sleeve with a screwdriver or similar utensil and attach it in place.

- ❑ **Installing the unit using the mounting bracket removed from the car**

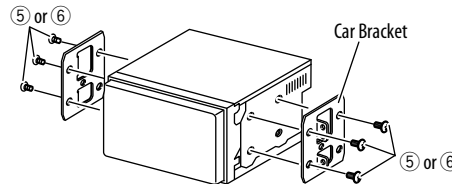

- Select the appropriate type of screw for the mounting bracket: flat head (⑤) or round head (⑥).

- ❑ **Installing the trim plate**

- 1 Attach the trim plate (②).

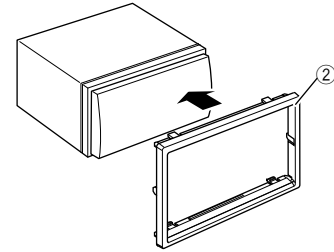

CONNECTION/INSTALLATION

Connection

Connecting wires to terminals

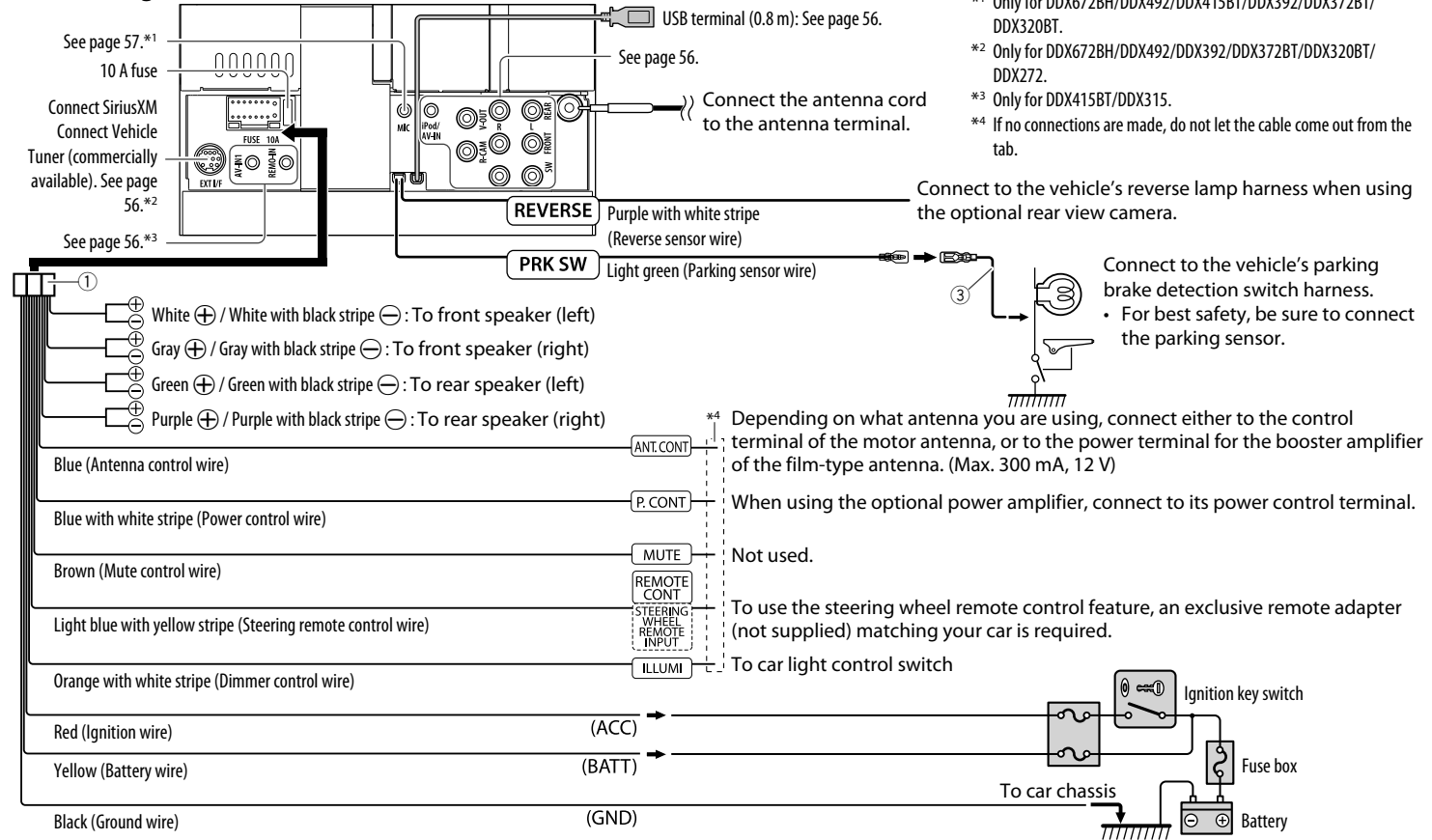

- *¹ Only for DDX672BH/DDX492/DDX415BT/DDX392/DDX372BT/DDX320BT.
- *² Only for DDX672BH/DDX492/DDX392/DDX372BT/DDX320BT/DDX272.
- *³ Only for DDX415BT/DDX315.
- *⁴ If no connections are made, do not let the cable come out from the tab.

CONNECTION/INSTALLATION

Connecting a USB device/iPod/iPhone

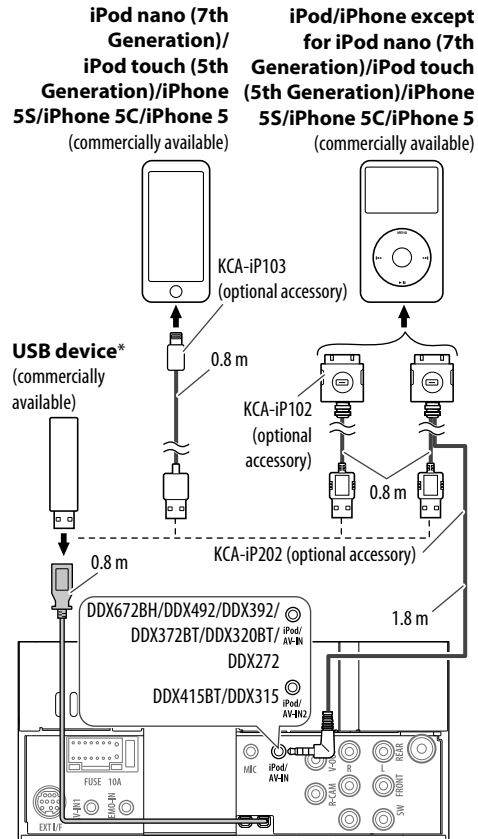

* Use CA-U1EX for extending the cable if necessary. (Max 500 mA, 5V)

Connecting external components

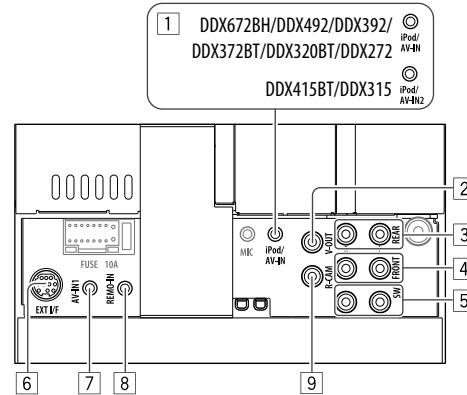

- 1 iPod/Audio Video input*¹
 - For DDX672BH/DDX492/DDX392/DDX372BT/DDX320BT/DDX272: iPod/AV-IN
 - For DDX415BT/DDX315: iPod/AV-IN2
- 2 Video output (Yellow)
- 3 Rear preout*²
 - Audio left output (White)
 - Audio right output (Red)

- 4 Front preout*²
 - Audio left output (White)
 - Audio right output (Red)
- 5 Subwoofer preout (monaural output)*²
 - Subwoofer left output (White)
 - Subwoofer right output (Red)
- 6 Expansion port for connecting SiriusXM Connect Vehicle Tuner (commercially available)*³
- 7 Audio Video input (AV-IN1)*¹*⁴
- 8 Steering wheel remote controller input*⁴
 - Connect to the vehicle's steering remote harness. Contact your Kenwood dealer for details.
- 9 Rear view camera input (Yellow)

- *¹ When connecting the component to play on "AV-IN" or "AV-IN1" / "AV-IN2", use the Audio and Video cable CA-C3AV (optional accessory).
- *² When connecting an external amplifier, connect its ground wire to the chassis of the car; otherwise the unit may be damaged.
- *³ Only for DDX672BH/DDX492/DDX392/DDX372BT/DDX320BT/DDX272.
- *⁴ Only for DDX415BT/DDX315.

CONNECTION/INSTALLATION

❑ Connecting microphone for Bluetooth (only for DDX672BH/DDX492/ DDX415BT/DDX392/DDX372BT/ DDX320BT)

Connect the microphone (7) to the MIC terminal.

- To install the microphone, peel off the adhesive tape, fix on the installation position, then adjust the direction of the microphone to face the driver. After installing, fix the microphone cable to the car with clamps (commercially available).

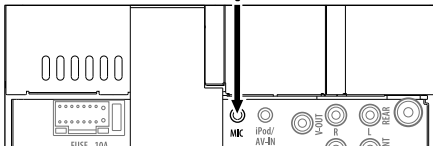
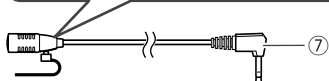
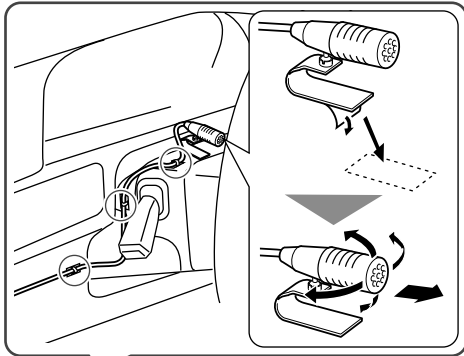

Removing the unit (Only for DDX672BH/DDX492/DDX392/ DDX372BT/DDX320BT/DDX272)

❑ Removing the trim plate

- 1 Engage the catch pins on the extraction key (4) and remove the two locks on the lower part. Lower the frame and pull it forward.

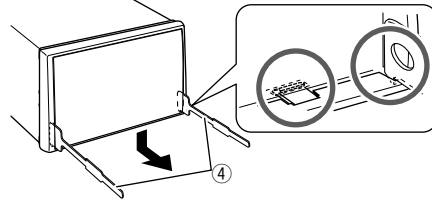

- 2 Remove from the upper two catches.

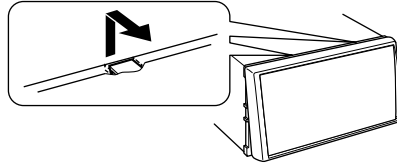

- The frame can be removed from the top side in the same manner.

❑ Removing the unit

- 1 Remove the trim plate. (See the left column.)
- 2 Insert the two extraction keys (4), then pull them as illustrated so that the unit can be removed.

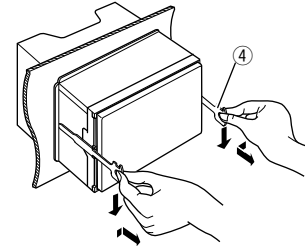

- Be careful to avoid injury from the catch pins on the extraction key.

REFERENCES

Maintenance

❑ Caution on cleaning the unit

Do not use any solvent (for example, thinner, benzine, etc.), detergent, or insecticide. This may damage the monitor or the unit.

Recommended cleaning method:

Gently wipe the panel with a soft, dry cloth.

❑ Moisture condensation

Moisture may condense on the lens inside the unit in the following cases:

- After starting the heater in the car.
- If it becomes very humid inside the car.

Should this occur, the unit may malfunction. In this case, eject the disc and leave the unit turned on for a few hours until the moisture evaporates.

❑ How to handle discs

- When removing a disc from its case, press down the center holder of the case and lift the disc out, holding it by the edges.



- Always hold the disc by the edges. Do not touch its recording surface.
- When storing a disc in its case, gently insert the disc around the center holder (with the printed surface facing up).
 - Make sure to store discs in their cases after use.

❑ To keep discs clean

Dirty discs may not play correctly.

If a disc does become dirty, wipe it with a soft cloth in a straight line from center to edge.



- Do not use any solvents (for example, conventional record cleaner, spray, thinner, benzine, etc.) to clean discs.

❑ To play new discs

New discs may have some rough spots around the inner and outer edges. If such a disc is used, this unit may reject the disc.



- To remove these rough spots, rub the edges with a pencil or ball-point pen, etc.

More information

❑ File playback

Playing DivX files*

- This unit can play back DivX files with the extension code <.divx>, <.div>, or <.avi> (regardless of the letter case—upper/lower).
- Audio stream should conform to MP3 or Dolby Digital.
- Files encoded in the interlaced scanning mode may not be played back correctly.
- The maximum bit rate for video signals (average) is 4 Mbps.

* Only for DDX415BT/DDX315.

Playing MPEG1/MPEG2 files

- This unit can play back MPEG1/MPEG2 files with the extension code <.mpg>, <.mpeg>, or <.mod>.
- The stream format should conform to MPEG system/program stream.
The file format should be MP@ML (Main Profile at Main Level)/SP@ML (Simple Profile at Main Level)/MP@LL (Main Profile at Low Level).
- Audio streams should conform to MPEG1 Audio Layer-2 or Dolby Digital.

Playing JPEG files

- This unit can play back JPEG files with the extension code <.jpg> or <.jpeg>.
- This unit can play back JPEG files that are at 32 x 32 to 8 192 x 7 680 resolution.
It may take time to display the file depending on its resolution.
- This unit can play back baseline JPEG files.
Progressive JPEG files or lossless JPEG files cannot be played.

REFERENCES

Playing MP3/WMA/WAV/AAC-LC files

- This unit can play back files with the extension code <.mp3>, <.wma>, <.wav> or <.m4a> (regardless of the letter case—upper/lower).
- This unit can play back files that meet the conditions below:
 - Bit rate:
 - MP3: 8 kbps – 320 kbps
 - WMA: 5 kbps – 320 kbps
 - AAC: 16 kbps – 320 kbps
 - Sampling frequency:
 - 8 kHz – 48 kHz (for MP3/WMA)
 - 44.1 kHz (for WAV)
 - 32 kHz – 48 kHz (for AAC)
- This unit can show ID3 Tag Version 1.0/1.1/2.2/2.3/2.4 (for MP3).
- This unit can also show WAV/WMA/AAC Tag.
- This unit can play back files recorded in VBR (variable bit rate).
- Files recorded in VBR have a discrepancy in elapsed time indication.
- This unit cannot play back the following files:
 - MP3 files encoded with MP3i and MP3 PRO format.
 - MP3 files encoded with Layer 1/2.
 - WMA files encoded with lossless, professional, and voice format.
 - WMA files which are not based upon Windows Media® Audio.
 - WMA/AAC files copy-protected with DRM.
 - AAC files encoded using any other application than iTunes.
 - AAC files copy-protected with FairPlay (except those stored on an iPod).
 - Files which have the data such as AIFF, ATRAC3, etc.

- This unit can display jacket pictures that meet the conditions below:
 - Picture size: 32 x 32 to 1 232 x 672 resolution
 - Data size: less than 650 KB.
 - File type: JPEG

Disc playback

Playable disc types

Disc type	Recording format, file type, etc.
DVD <ul style="list-style-type: none"> DTS sound cannot be reproduced or emitted from this unit. 	DVD Video* ¹
DVD Recordable/Rewritable (DVD-R/-RW*², +R/+RW*³) <ul style="list-style-type: none"> DVD Video: UDF bridge DivX*⁴/MPEG1/MPEG2/JPEG/MP3/WMA/WAV/AAC: ISO 9660 level 1, level 2, Romeo, Joliet 	<ul style="list-style-type: none"> DVD Video DivX*⁴/MPEG1/MPEG2 JPEG MP3/WMA/WAV/AAC
Dual Disc	DVD side
CD/VCD	<ul style="list-style-type: none"> VCD (Video CD) Audio CD/CD Text (CD-DA)
CD Recordable/Rewritable (CD-R/-RW) <ul style="list-style-type: none"> ISO 9660 level 1, level 2, Romeo, Joliet 	<ul style="list-style-type: none"> VCD (Video CD) CD-DA MPEG1/MPEG2 JPEG MP3/WMA/WAV/AAC

*¹ DVD Region code:

For DDX672BH/DDX492/DDX392/DDX372BT/DDX320BT/DDX272: 1
For DDX415BT/DDX315: 4

If you insert a DVD Video disc of an incorrect Region Code, "Region Code Error" appears on the screen.

*² DVD-R recorded in multi-border format is also playable (except for dual layer discs). DVD-RW dual layer discs are not playable.

*³ It is possible to play back finalized +R/+RW (Video format only) discs. "DVD" is selected as the disc type when a +R/+RW disc is loaded. +RW double layer discs are not playable.

*⁴ Only for DDX415BT/DDX315.

Unplayable discs

- Unplayable disc types and formats are as follows:
 - DVD-Audio/DVD-ROM discs
 - MPEG4/DivX*/DVD-VR/DVD+VR/DVD-RAM recorded in the DVD-R/RW or +R/+RW
 - DTS-CD, SVCD (Super Video CD), CD-ROM, CD-I (CD-I Ready)
 - DivX/MPEG4 recorded in the CD-R/RW
- Discs that are not round.
- Discs with coloring on the recording surface or discs that are dirty.
- Recordable/Rewritable discs that have not been finalized.
- 3 inch discs. Attempting to insert using an adapter may cause malfunction.

* Only for DDX672BH/DDX492/DDX392/DDX372BT/DDX320BT/DDX272.

DualDisc playback

The Non-DVD side of a "DualDisc" does not comply with the "Compact Disc Digital Audio" standard. Therefore, the use of Non-DVD side of a DualDisc on this product cannot be recommended.

REFERENCES

Playing Recordable/Rewritable discs

- This unit can recognize a total of 5 000 files and 250 folders (a maximum of 999 files per folder).
- Use only “finalized” discs.
- This unit can play back multi-session discs; however, unclosed sessions will be skipped while playing.
- Some discs or files may not be played back due to their characteristics or recording conditions.

❑ About data stored in the connected USB device/iPod/iPhone

- We bear no responsibility for any loss of data in an iPod/iPhone and USB mass storage class device while using this unit.

❑ USB playback

Playable files on a USB device

- This unit can play JPEG/DivX*/MPEG1/MPEG2/MP3/WMA/WAV/AAC files stored in a USB mass storage class device.
- This unit can recognize a total of 5 000 files and 250 folders (a maximum of 999 files per folder).
- Make sure all important data has been backed up to avoid losing the data.

* Only for DDX415BT/DDX315.

Notes on using a USB device:

- This unit may not play back files in a USB device properly when using a USB extension cable.
- USB devices equipped with special functions such as data security functions cannot be used with the unit.
- Do not use a USB device with 2 or more partitions.

- Depending on the shape of the USB devices and connection ports, some USB devices may not be attached properly or the connection might be loose.
- This unit may not recognize a memory card inserted into the USB card reader.
- When connecting with a USB cable, use the USB 2.0 cable.
- The maximum number of characters (when the characters are 1 byte):
 - Folder names: 50 characters
 - File names: 50 characters
- Avoid using the USB device if it might affect driving safety.
- Do not pull out and connect the USB device repeatedly while “Reading” is shown on the screen.
- Electrostatic shock when connecting a USB device may cause abnormal playback of the device. In this case, disconnect the USB device then reset this unit and the USB device.
- Operation and power supply may not work as intended for some USB devices.
- Do not leave a USB device in the car, or expose to direct sunlight or high temperatures to avoid deformation or damage to the device.

❑ Notes on playing iPod/iPhone

- iPod/iPhone that can be connected to this unit:
Made for
 - iPod with video
 - iPod classic
 - iPod nano (7th Generation)*
 - iPod nano (6th Generation)
 - iPod nano (5th Generation)
 - iPod nano (4th Generation)

- iPod nano (3rd Generation)
- iPod touch (5th Generation)*
- iPod touch (4th Generation)
- iPod touch (3rd Generation)
- iPod touch (2nd Generation)
- iPod touch (1st Generation)
- iPhone 5S*
- iPhone 5C*
- iPhone 5*
- iPhone 4S
- iPhone 4
- iPhone 3GS
- iPhone 3G
- iPhone

* You cannot watch video when connecting iPod nano (7th Generation)/iPod touch (5th Generation)/iPhone 5S/iPhone 5C/iPhone 5.

- When operating iPod/iPhone, some operations may not be performed correctly or as intended. In this case, visit the following KENWOOD web site: <www.kenwood.com/cs/ce/ipod>
- For some iPod/iPhone models, the performance may be abnormal or unstable during operation. In this case, disconnect the iPod/iPhone device, then check its condition. If the performance is not improved or slow, reset your iPod/iPhone.
- When you turn on this unit, the iPod/iPhone is charged through the unit.
- The text information may not be displayed correctly.

REFERENCES

Language codes (for DVD language selection)

AA	Afar	GL	Galician	MI	Maori	SO	Somali
AB	Abkhazian	GN	Guarani	MK	Macedonian	SQ	Albanian
AF	Afrikaans	GU	Gujarati	ML	Malayalam	SR	Serbian
AM	Ameharic	HA	Hausa	MN	Mongolian	SS	Siswati
AR	Arabic	HI	Hindi	MO	Moldavian	ST	Sesotho
AS	Assamese	HR	Croatian	MR	Marathi	SU	Sundanese
AY	Aymara	HU	Hungarian	MS	Malay (MAY)	SW	Swahili
AZ	Azerbaijani	HY	Armenian	MT	Maltese	TA	Tamil
BA	Bashkir	IA	Interlingua	MY	Burmese	TE	Telugu
BE	Byelorussian	IE	Interlingue	NA	Nauru	TG	Tajik
BG	Bulgarian	IK	Inupiak	NE	Nepali	TH	Thai
BH	Bihari	IN	Indonesian	NO	Norwegian	TI	Tigrinya
BI	Bislama	IS	Icelandic	OC	Occitan	TK	Turkmen
BN	Bengali, Bangla	IW	Hebrew	OM	(Afan) Oromo	TL	Tagalog
BO	Tibetan	JA	Japanese	OR	Oriya	TN	Setswana
BR	Breton	JI	Yiddish	PA	Panjabi	TO	Tonga
CA	Catalan	JW	Javanese	PL	Polish	TR	Turkish
CO	Corsican	KA	Georgian	PS	Pashto, Pushto	TS	Tsonga
CS	Czech	KK	Kazakh	QU	Quechua	TT	Tatar
CY	Welsh	KL	Greenlandic	RM	Rhaeto-Romance	TW	Twi
DZ	Bhutani	KM	Cambodian	RN	Kirundi	UK	Ukrainian
EL	Greek	KN	Kannada	RO	Rumanian	UR	Urdu
EO	Esperanto	KO	Korean (KOR)	RW	Kinyarwanda	UZ	Uzbek
ET	Estonian	KS	Kashmiri	SA	Sanskrit	VI	Vietnamese
EU	Basque	KU	Kurdish	SD	Sindhi	VO	Volapuk
FA	Persian	KY	Kirghiz	SG	Sangho	WO	Wolof
FI	Finnish	LA	Latin	SH	Serbo-Croatian	XH	Xhosa
FJ	Fiji	LN	Lingala	SI	Singhalese	YO	Yoruba
FO	Faroese	LO	Laothian	SK	Slovak	ZU	Zulu
FY	Frisian	LT	Lithuanian	SL	Slovenian		
GA	Irish	LV	Latvian, Lettish	SM	Samoaan		
GD	Scots Gaelic	MG	Malagasy	SN	Shona		

Error message list

If an error occurs while using the unit, a message appears. Take appropriate action according to the following message/remedy/cause list.

“No Signal”:

- Start the playback on the external component connected to the Audio Video or iPod/Audio Video input terminal.
- Check the cords and connections.
- Signal input is too weak.

“Miswiring DC Offset Error”/“Warning DC Offset Error”:

- A speaker cord has shorted or it has come into contact with the car chassis. Wire or insulate the speaker cord as appropriate, then reset the unit. (Pages 3 and 55)

“Parking Off”:

- No playback picture is shown when the parking brake is not engaged.

“Authorization Error”:

- Check whether the connected iPod/iPhone is compatible with this unit. (Page 60)

“USB Device Error”:

- The USB power voltage is abnormal.
- Turn off and turn on the unit.
- Connect another USB device.

“Panel Mecha Error”:

- The panel does not work properly. Reset the unit.

Continued to the next page...

REFERENCES

“Connection Error”:

- The device is registered but the connection has failed. Connect the registered device. (Page 36)

“Please Wait...”:

- The unit is preparing to use the Bluetooth function. If the message does not disappear, turn off and turn on the unit, then connect the device again (or reset the unit).

“No Voice Device”:

- The connected mobile phone does not have a voice recognition system.

“No Data”:

- No phone book data is contained in the connected Bluetooth phone.

“Initialize Error”:

- The unit has failed to initialize the Bluetooth module. Try the operation again.

“Dial Error”:

- Dialing has failed. Try the operation again.

“Hung Up Error”:

- The call has not ended yet. Park your car, and use the connected mobile phone to end the call.

“Pick Up Error”:

- The unit has failed to receive a call.

“Please update Pandora App”:

- The Pandora application on your iPod touch/iPhone/Android/BlackBerry is not the latest version. Update the application.

“Check App”:

- The Pandora application on your iPod touch/iPhone/Android/BlackBerry is not started up.
- The Pandora application is not installed in the connected device.
- An error has occurred in the Pandora application.

“Login Error”:

- You have not been signed into Pandora.

“No skips remaining”:

- No more songs can be skipped.

“Failed to save your thumb rating”:

- Thumb-up/down is prohibited.

“No Station”:

- No station is available.

“No Active Station”:

- No station is being played.

“Station limit reached”:

- The Station List is full and no more stations can be registered.

“Failed to save your bookmark”:

- The unit has failed to save a bookmark. Try the operation again.

“Limited Connectivity”:

- The connection with the Pandora application cannot be established.

“Pandora not available”:

- You cannot use the Pandora application from the area where you are currently trying to access Pandora.

“Try again later”:

- The Pandora server is under maintenance.

“Station does not exist”:

- The selected station has been deleted by another device or has expired.

“Cannot create a Station”:

- You cannot create a station during the read-only mode or when network connection is not established.

“SXM No Signal”:

- Make sure the SiriusXM Satellite Radio antenna is mounted outside the vehicle. Move the vehicle to an area with a clear view of the sky.

“SXM Check Antenna”:

- Check the SiriusXM Satellite Radio antenna connection, and make sure the antenna is firmly attached to the tuner.
- Check whether the SiriusXM Satellite Radio antenna cable is bent or broken. If it is damaged, replace the whole antenna unit.

“SXM Check Tuner”:

- Make sure the SiriusXM Connect Vehicle Tuner is connected to the unit.

“SXM Chan Unavailable” (appears on the screen for about 2 seconds, then returns to the previous channel):

- The selected channel is no longer available. Select another channel or continue listening to the previous channel.

“SXM Ch Unsubscribed” (appears on the screen for about 2 seconds, then returns to the previous channel):

- The selected channel is not part of your current subscription plan. Call 1-866-635-2349 to subscribe.

REFERENCES

“SXM Subscription Updated – Press Enter to Continue”:

- Your subscription has been updated. Press the appropriate button to continue.

“SXM Channel Locked”

- The selected channel has been locked by the parental controls. Enter the unlock code when you are asked. (Page 30)

“SXM Incorrect Lock Code”

- The selected channel is a mature or parental lock channel, and locked by the parental lock or user lock code. Enter the correct lock code.

Troubleshooting

What appears to be trouble is not always serious. Check the following points before calling a service center.

- For operations with the external components, refer also to the instructions supplied with the adapters used for the connections (as well as the instructions supplied with the external components).

❑ General

No sound comes out of the speakers.

- Adjust the volume to the optimum level.
- Check the cords and connections.

No picture is displayed on the screen.

- Turn on the screen. (Page 8)

The unit does not work at all.

- Reset the unit. (Page 3)

The remote controller* does not work.

- Replace the battery.

* For DDX672BH/DDX492/DDX392/DDX372BT/DDX320BT/DDX272: Purchase KNA-RCDV331 separately.

The desired source button ([AV-IN], [AV-IN2] or [APPS]) cannot be selected on the <TOP MENU> screen.

- Select an appropriate setting for <AV Input>. (Page 17)

❑ Discs in general

Recordable/Rewritable discs cannot be played back.

- Insert a finalized disc.
- Finalize the discs with the component which you used for recording.

Tracks on the Recordable/Rewritable discs cannot be skipped.

- Insert a finalized disc.
- Finalize the discs with the component which you used for recording.

Playback does not start.

- The file format is not supported by the unit.

No picture appears on the external monitor.

- Connect the video cord correctly.
- Select the correct input on the external monitor.

❑ DivX*/MPEG1/MPEG2/JPEG/MP3/WMA/WAV/AAC

Discs cannot be played back.

- Record the tracks using a compliant application on the appropriate discs. (Page 59)
- Add appropriate extension codes to the file names.

* Only for DDX415BT/DDX315.

Tracks are not played back as you have intended them to play.

- Playback order may differ from the one played back using other players.

❑ USB

“Reading” does not disappear from the screen.

- Turn the power off and on again.

While playing a track, sound is sometimes interrupted.

- The tracks are not properly copied onto the USB device. Copy the tracks again, and try again.

REFERENCES

iPod/iPhone

No sound comes out of the speakers.

- Disconnect the iPod/iPhone, then connect it again.
- Select another source, then reselect “iPod”.

The iPod/iPhone does not turn on or does not work.

- Check the connecting cable and its connection.
- Update the firmware version.
- Charge the battery.
- Reset the iPod/iPhone.

Sound is distorted.

- Deactivate the equalizer either on this unit or the iPod/iPhone.

A lot of noise is generated.

- Turn off (uncheck) “VoiceOver” of the iPod/iPhone. For details, visit <<http://www.apple.com>>.

No operations are available when playing back a track containing Artwork.

- Operate the unit after the Artwork has loaded.

Sound does not synchronize with the video.

- Select [iPod] for <AV Input>. (Page 17)

Videos cannot be played.

- Connect with USB Audio and Video cable KCA-iP202. Other cables cannot be used.
- Select [iPod] for <AV Input>. (Page 17)

Videos have no sound.

- Connect with USB Audio and Video cable KCA-iP202. Other cables cannot be used.
- Select [iPod] for <AV Input>. (Page 17)

Tuner

AME automatic presetting does not work.

- Store stations manually. (Page 26)

Static noise while listening to the radio.

- Connect the antenna firmly.

AV-IN*1/AV-IN1*2/AV-IN2*2

No picture appears on the screen.

- Turn on the video component if it is not on.
- Connect the video component correctly.
- For DDX672BH/DDX492/DDX392/DDX372BT/DDX320BT/DDX272: set <AV Input> to [AV-IN]
- For DDX415BT/DDX315: When “AV-IN2” is selected as the source, set <AV Input> to [AV-IN2].

*1 Only for DDX672BH/DDX492/DDX392/DDX372BT/DDX320BT/DDX272.

*2 Only for DDX415BT/DDX315.

HD Radio reception (only for DDX672BH/DDX492)

Sound quality changes when receiving HD Radio stations.

- Fix the reception mode either to [DIGITAL] or [ANALOG]. (Page 25)

No sound can be heard.

- The HD Radio reception mode is not appropriate. Select the appropriate mode from [DIGITAL], [ANALOG] or [AUTO].

Pandora (only for DDX672BH/DDX492/DDX392/DDX372BT/DDX320BT/DDX272)

The Pandora application does not work.

- The Pandora application on your iPod touch/iPhone/Android/BlackBerry is not the latest version. Update the application.

Bluetooth (only for DDX672BH/DDX492/DDX415BT/DDX392/DDX372BT/DDX320BT)

Phone sound quality is poor.

- Reduce the distance between the unit and the Bluetooth mobile phone.
- Move the car to a place where you can get a better signal reception.

The sound is interrupted or skipped while using a Bluetooth audio player.

- Reduce the distance between the unit and the Bluetooth audio player.
- Disconnect the device connected for Bluetooth phone.
- Turn off, then turn on the unit.
- (If the sound is not yet restored) connect the player again.

The connected audio player cannot be controlled.

- Check whether the connected audio player supports AVRCP (Audio Video Remote Control Profile).

Bluetooth device does not detect the unit.

- Search from the Bluetooth device again.

REFERENCES

The unit does not pair with the Bluetooth device.

- For devices compatible with Bluetooth 2.1:
Register the device using a PIN code. (Page 35)
- For devices compatible with Bluetooth 2.0:
Enter the same PIN code for both the unit and target device. If the PIN code of the device is not indicated in its instructions, try "0000" or "1234".

Echo or noise occurs.

- Adjust the microphone unit position.
- Adjust the echo volume and the noise reduction volume. (Page 37)

The unit does not respond when you try to copy the phone book to the unit.

- You may have tried to copy the same entries (as stored) to the unit.

Specifications

□ Monitor section

Picture Size (W x H)

DDX672BH:

6.95 inches (diagonal) wide
156.6 mm × 81.6 mm (6-3/16" ×
3-3/16")

DDX492/DDX415BT/DDX392/DDX372BT/
DDX320BT/DDX315/DDX272:

6.2 inches (diagonal) wide
137.5 mm × 77.2 mm (5-7/16" ×
3-1/16")

Display System Transparent TN LCD panel

Drive System TFT active matrix system

Number of Pixels 1 152 000 (800H × 480V × RGB)

Effective Pixels 99.99%

Pixel Arrangement
RGB striped arrangement

Back Lighting LED

□ DVD player section

D/A Converter 24 bit

Audio Decoder Linear PCM/Dolby Digital/MP3/
WMA/AAC/WAV

Video Decoder MPEG1/MPEG2/DivX*

Wow & Flutter Below Measurable Limit

Frequency Response

96 kHz Sampling: 20 Hz – 22 000 Hz

48 kHz Sampling: 20 Hz – 22 000 Hz

44.1 kHz Sampling: 20 Hz – 20 000 Hz

Total Harmonic Distortion

0.010% (1 kHz)

Signal to Noise Ratio

99 dB (DVD-Video 96 kHz)

Dynamic Range 99 dB (DVD-Video 96 kHz)

Disc Format DVD-Video/VIDEO-CD/CD-DA

Sampling Frequency

44.1 kHz/48 kHz/96 kHz

Quantifying Bit Number

16/20/24 bit

* Only for DDX415BT/DDX315.

□ USB interface section

USB Standard USB 2.0 Full Speed

File System FAT 16/32

Maximum Power Supply Current
DC 5 V $\overline{\text{---}}$ 1 A

D/A Converter 24 bit

Audio Decoder MP3/WMA/AAC/WAV

Video Decoder MPEG1/MPEG2/DivX*

* Only for DDX415BT/DDX315.

□ Bluetooth section (only for DDX672BH/ DDX492/DDX415BT/DDX392/ DDX372BT/DDX320BT)

Technology Bluetooth 2.1 + EDR

Frequency 2.402 GHz – 2.480 GHz

Output Power +4 dBm (MAX), 0 dBm (AVE),
Power Class 2

Maximum Communication Range

Line of sight approx. 10 m
(32.8 ft)

Audio Codec SBC

Profile HFP (V1.5) (Hands Free Profile)
SPP (Serial Port Profile)

SDP (Service Discovery Profile)
A2DP (Advanced Audio
Distribution Profile)

AVRCP (Audio/Video Remote
Control Profile)

OPP (Object Push Profile)

PBAP (Phonebook Access Profile)

GAP (Generic Access Profile)

REFERENCES

FM tuner section

Frequency Range

DDX672BH/DDX492/DDX392/DDX372BT/
DDX320BT/DDX272:

87.9 MHz to 107.9 MHz (200 kHz)

DDX415BT/DDX315:

87.5 MHz to 108.0 MHz (50 kHz)

Usable Sensitivity (S/N: 30 dB)

7.2 dBf (0.63 μ V/75 Ω)

Quieting Sensitivity (S/N: 50 dB)

15.2 dBf (1.58 μ V/75 Ω)

Frequency Response (\pm 3.0 dB)

Digital: 20 Hz – 20 kHz*

Analog: 30 Hz – 15 kHz

Signal to Noise Ratio

Digital: 75 dB (STEREO)*

Analog: 68 dB (MONO)

Selectivity (\pm 400 kHz)

\geq 80 dB

Stereo Separation 40 dB (1 kHz)

* Only for DDX672BH/DDX492.

AM tuner section

Frequency Range (10 kHz)

530 kHz to 1 700 kHz

Usable Sensitivity 29 dB μ

Frequency Response (\pm 3.0 dB)

Digital: 40 Hz – 15 kHz*

Signal to Noise Ratio

Digital: 75 dB (STEREO)*

* Only for DDX672BH/DDX492.

Video section

Color System of External Video Input

NTSC/PAL

External Video Input Level (mini jack)

1 Vp-p/75 Ω

External Audio Max Input Level (mini jack)

2 V/25 k Ω

Video Input Level (RCA jack)

1 Vp-p/75 Ω

Video Output Level (RCA jack)

1 Vp-p/75 Ω

Audio section

Maximum Power (Front & Rear)

50 W \times 4

Full Bandwidth Power (Front & Rear)

(4 Ω , 14.4 V, 1% THD)

22 W \times 4

Preout Level

4 V/10 k Ω

Preout Impedance \leq 600 Ω

Speaker Impedance 4 Ω – 8 Ω

Graphic Equalizer

BAND 5 Band

Frequency (Hz) (BAND1-5)

80/200/800/4k/12.5k

Gain -8/-7/-6/-5/-4/-3/-2/-1/

0/1/2/3/4/5/6/7/8 [dB]

2Way X'Over

HIGH PASS FILTER frequency

Through/63/100/120/150/
180 [Hz]

LOW PASS FILTER frequency

55/85/120/160/Through [Hz]

Subwoofer Level -50 dB to +10 dB

General

Operating Voltage

14.4 V (10.5 V – 16 V allowable)

Maximum Current Consumption

10 A

Installation Dimensions (W \times H \times D)

DDX672BH: 182 mm \times 111 mm \times 165 mm
(7-3/16" \times 4-7/16" \times 6-1/2")

DDX492/DDX392/DDX372BT/DDX320BT/DDX272:

182 mm \times 111 mm \times 160 mm
(7-3/16" \times 4-7/16" \times 6-5/16")

DDX415BT/DDX315:

178mm \times 100 mm \times 162 mm
(7" \times 3-7/8" \times 6-3/8")

Operational Temperature Range

-10°C – +60°C

Weight

DDX672BH: 2.3 kg (5.1 lbs)

DDX492/DDX415BT/DDX392/DDX372BT/
DDX320BT/DDX315/DDX272:

1.7 kg (3.7 lbs)

Design and specifications are subject to change without notice.

REFERENCES

☐ Trademarks and licenses

- Manufactured under license from Dolby Laboratories. Dolby and the double-D symbol are trademarks of Dolby Laboratories.
- “DVD Logo” is a trademark of DVD Format/Logo Licensing Corporation registered in the US, Japan and other countries.
- The “AAC” logo is a trademark of Dolby Laboratories.
- Microsoft and Windows Media are either registered trademarks or trademarks of Microsoft Corporation in the United States and/or other countries.
- “Made for iPod,” and “Made for iPhone” mean that an electronic accessory has been designed to connect specifically to iPod, or iPhone, respectively, and has been certified by the developer to meet Apple performance standards. Apple is not responsible for the operation of this device or its compliance with safety and regulatory standards. Please note that the use of this accessory with iPod, or iPhone may affect wireless performance. iPhone, iPod, iPod classic, iPod nano, and iPod touch are trademarks of Apple Inc., registered in the U.S. and other countries.
- Lightning is a trademark of Apple Inc.
- This item incorporates copy protection technology that is protected by U.S. patents and other intellectual property rights of Rovi Corporation. Reverse engineering and disassembly are prohibited.
- Font for this product is designed by Ricoh.
- DivX Certified® to play DivX® video, including premium content.
- DivX®, DivX Certified® and associated logos are trademarks of Rovi Corporation or its subsidiaries and are used under license.
- ABOUT DIVX VIDEO: DivX® is a digital video format created by DivX, LLC, a subsidiary of Rovi Corporation. This is an official DivX Certified® device that has passed rigorous testing to verify that it plays DivX video. Visit divx.com for more information and software tools to convert your files into DivX videos.
- ABOUT DIVX VIDEO-ON-DEMAND: This DivX Certified® device must be registered in order to play purchased DivX Video-on-Demand (VOD) movies. To obtain your registration code, locate the DivX VOD section in your device setup menu (Page 50). Go to vod.divx.com for more information on how to complete your registration.
- THIS PRODUCT IS LICENSED UNDER THE MPEG-4 VISUAL PATENT PORTFOLIO LICENSE FOR THE PERSONAL AND NON-COMMERCIAL USE OF A CONSUMER FOR (i) ENCODING VIDEO IN COMPLIANCE WITH THE MPEG-4 VISUAL STANDARD (“MPEG-4 VIDEO”) AND/OR (ii) DECODING MPEG-4 VIDEO THAT WAS ENCODED BY A CONSUMER ENGAGED IN A PERSONAL AND NON-COMMERCIAL ACTIVITY AND/OR WAS OBTAINED FROM A VIDEO PROVIDER LICENSED BY MPEG LA TO PROVIDE MPEG-4 VIDEO. NO LICENSE IS GRANTED OR SHALL BE IMPLIED FOR ANY OTHER USE. ADDITIONAL INFORMATION INCLUDING THAT RELATING TO PROMOTIONAL, INTERNAL AND COMMERCIAL USES AND LICENSING MAY BE OBTAINED FROM MPEG LA, LLC. SEE [HTTP://WWW.MPEGLA.COM](http://WWW.MPEGLA.COM).
- Pandora, the Pandora logo, and the Pandora trade dress are trademarks or registered trademarks of Pandora Media, Inc., used with permission.
- HD Radio Technology manufactured under license from iBiquity Digital Corporation. U.S. and Foreign Patents. HD Radio™ and the HD, HD Radio, and “Arc” logos are proprietary trademarks of iBiquity Digital Corp.
- Sirius, XM and all related marks and logos are trademarks of Sirius XM Radio Inc. All rights reserved.
- Android is a trademark of Google Inc.
- BlackBerry®, RIM®, Research In Motion® and related trademarks, names and logos are the property of Research In Motion Limited and are registered and/or used in the U.S. and countries around the world. Used under license from Research In Motion Limited.
- The Bluetooth® word mark and logos are registered trademarks owned by Bluetooth SIG, Inc. and any use of such marks by JVC KENWOOD Corporation is under license. Other trademarks and trade names are those of their respective owners.

KENWOOD

Download from www.Somanuals.com. All Manuals Search And Download.

Free Manuals Download Website

<http://myh66.com>

<http://usermanuals.us>

<http://www.somanuals.com>

<http://www.4manuals.cc>

<http://www.manual-lib.com>

<http://www.404manual.com>

<http://www.luxmanual.com>

<http://aubethermostatmanual.com>

Golf course search by state

<http://golfingnear.com>

Email search by domain

<http://emailbydomain.com>

Auto manuals search

<http://auto.somanuals.com>

TV manuals search

<http://tv.somanuals.com>