

KENWOOD

Z920DVD

DVD-RECEIVER

INSTRUCTION MANUAL

KENWOOD CORPORATION

This player has been designed to play back the DVD software which has been encoded for specific region areas. It cannot play back the DVD software encoded for other region areas than the region areas for which it has been designed.



B64-2066-00 (EW)

Contents

Safety precautions	3
Handling discs	6
Before Use	8
General features	
Power	10
Volume	10
Attenuator	11
Switching Modes	11
Switching Display Mode	12
Switching the Upper Part Display	12
Switching the Lower Part Display	14
Switching Full-Screen Display	15
Switching Display	
during the Standby mode	16
TEL Mute	16
Theft Deterrent Faceplate	16
Audio effect control features	
System Q	18
Speaker setting	18
Non-Fading Output	18
Audio Control Setting	19
1. Bass Centre Frequency	19
2. Bass Level	19
3. Bass Quality Factor	19
4. Bass Extend	19
5. Middle Centre Frequency	20
6. Middle Level	20
7. Middle Quality Factor	20
8. Treble Centre Frequency	20
9. Treble Level	20
10. Balance Level	20
11. Fader Level	20
12. Non-Fading Level	20
13. Volume Offset	21
Crossover Network Control Setting	21
1. High-pass Filter Frequency	
for Front Output	21
2. High-pass Filter Frequency	
for Rear Output	22
3. Low-pass Filter Frequency	
for Non-Fading Output	22
4. Phase for Non-Fading Output	22
Spatializer® Control Setting	22
Dual Zone System	23
Audio Control Setting	24
1. Balance Level	24
2. Fader Level	24
3. Sub Woofer Level	24
4. Volume Offset	24
Crossover Network Control Setting	25
1. High-pass Filter for Front Output	25
2. Delay Time for	
the Front Right Speaker	25
3. Delay Time for	
the Front Left Speaker	25
4. High-pass Filter for Rear Output	25
5. Delay Time for	
the Rear Right Speaker	26
6. Delay Time for	
the Rear Left Speaker	26
7. Low-pass Filter	
for Sub Woofer Output	26
8. Delay Time for the Sub Woofer	26
9. High-pass Filter for Centre Output	26
10. Delay Time for the Centre Speaker	27
11. Phase for Sub Woofer Output	27
12. Storing Your Setting of the	
Crossover network/Delay time	27
Surround Processor Control Setting	27
1. Recalling the kenwood Preset Sound	27
2. Parametric Equalizer	28
3. Storing Your Setting of	
the Parametric Equalizer	28
4. Selecting the Position Mode	28
5. Using the DOLBY PRO LOGIC	28
6. Selecting the Acoustic Image	29
7. Turning the Centre Output On/Off	29
8. Selecting the Multi Channel	29
9. Turning the Sub Woofer	
Output On/Off	29
10. Setting the Channel Balance	30

Tuner features

Tuning	31
Direct Access Tuning	32
Station Preset Memory	32

RDS features

RDS (Radio Data System)	33
Enhanced Other Network	33
Alarm	33
Traffic Information Function	34
Presetting Volume for Traffic	
Information/News	34
Programme Type (PTY) Function	34
Changing Language for	
Programme Type (PTY) Function	36
Radio Text Scroll	36

DVD/VCD/CD player features

Playing DVDs / VCDs / CDs	38
Forward / Reverse Search Disc Play	38
Chapter / Track Search	39
Next Play / Previous Play	39
Track Search	39
Track Repeat	39
Pausing and Restarting Disc Play	39

DVD/VCD Setup Menu features

Selecting to the DVD setup menu	40
Setting the Priority	
Language for Voice	40
Setting the Priority	
Language for Subtitle	41
Setting the Priority	
Language for Disc Menu	41
Setting the Rating Level	44
Setting the Optical Output Mode	45
Setting the Dynamic Range	45
Setting the Audio 2x search	45
Setting the Screen Mode	46
Setting the Close Caption	46
Setting the Colour Scheme	46
Setting the Zoom Setup	47

Safety precautions

⚠WARNING

To prevent injury and/or fire, take the following precautions:

- Insert the unit all the way until it is fully locked in place. Otherwise it may fly out of place during collisions and other jolts.
- When extending the ignition, battery or ground cables, make sure to use automotive-grade cables or other cables with an area of 0.75mm² (AWG18) or more to prevent cable deterioration and damage to the cable coating.
- To prevent short circuits, never put or leave any metallic objects (e.g., coins or metal tools) inside the unit.
- If the unit starts to emit smoke or strange smells, turn off the power immediately and consult your Kenwood dealer.
- Make sure not to get your fingers caught between the faceplate and the unit.
- Be careful not to drop the unit or subject it to strong shock.
The unit may break or crack because it contains glass parts.

External disc control features

Playing Other Disc mode	48
Fast Forwarding and Reversing	
Disc Play	48
Track Search	48
Disc Search	49
Track / Disc Repeat	49
Track Scan	49
Random Play	49
Magazine Random Play	50
Text Scroll	50
Presetting Disc Names (DNPS)	50

Menu settings

Menu System	53
Code Security Function	54
Touch Sensor Tone	55
Manual Time Adjustment	55
Calendar Adjustment	56
Calendar Mode	56
Automatic Time Adjustment	56
Disabled System Indicator (DSI)	56
Icon/Spectrum analyzer Select	57
Font Select	57
Dimmer	57
Loudness	57
System Q	58
External Amp Control	58
News Bulletin Function	
with PTY News Timeout Setting	58
Local Seek Function	58
Selecting Tuning Mode	58
Auto Memory Entry	59
AF (Alternative Frequency) Function	59
Restricting RDS Region	
(Region Restrict Function)	59
Auto TP Seek Function	60
Monaural Reception	60
Text Scroll	60
Power OFF Timer	60
Built-in AUX Control	60

Basic Operations

of remote control	61
Basic operations	62
FM/AM Control Function	62
DVD/VCD/CD Control Function	63
External Disc Control Function	65

Installation

Accessories	66
Installation Procedure	66
Connecting Cables to Terminals	67
Installation	69

Troubleshooting Guide

Specifications

Safety precautions

▲CAUTION

To prevent damage to the machine, take the following precautions:

- Make sure to ground the unit to a negative 12V DC power supply.
- Do not open the top or bottom covers of the unit.
- Do not install the unit in a spot exposed to direct sunlight or excessive heat or humidity. Also avoid places with too much dust or the possibility of water splashing.
- Do not subject the faceplate to excessive shock, as it is a piece of precision equipment.
- When replacing a fuse, only use a new one with the prescribed rating. Using a fuse with the wrong rating may cause your unit to malfunction.
- To prevent short circuits when replacing a fuse, first disconnect the wiring harness.
- Do not place any object between the faceplate and the unit.
- During installation, do not use any screws except for the ones provided. The use of improper screws might result in damage to the main unit.
- Do not apply excessive force to the open faceplate or place objects on it. Doing so will cause damage or breakdown.

IMPORTANT INFORMATION About the disc changer to be connected:

To connect a disc changer having the "O-N" switch to this unit, set the "O-N" switch to "N".

When you connect a model with no "O-N" switch, the converter cord CA-DS100 available as an option may be required. For details, consult your Kenwood dealer. If a model with no "O-N" switch is connected, some unavailable functions and information that cannot be displayed are generated, such as the DNPS, Magazine random play, and CD Text display.

Note that none of the KDC-C100, KDC-C302, C205, C705, and non-Kenwood CD changers can be connected.

▲CAUTION

You can damage both your unit and the CD changer if you connect them incorrectly.

Do Not Load 8-cm (3-in.) CDs in the CD slot

If you try to load an 8-cm CD with its adapter into the unit, the adapter might separate from the CD and damage the unit.

NOTE

- If you experience problems during installation, consult your Kenwood dealer.
- If the unit fails to operate properly, press the Reset button. The unit returns to factory settings when the Reset button is pressed. If the unit still fails to operate properly after the Reset button has been pressed, contact your local KENWOOD dealer for assistance.
- Press the reset button if the CD auto changer is first controlled and operates incorrectly. The original operating condition will return.

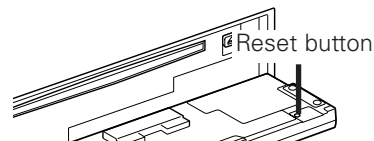

- We strongly recommend the use of the Code Security function (page 54) to prevent theft.

- The illustrations of the display and the panel appearing in this manual are examples used to explain more clearly how the controls are used. Therefore, what appears on the display in the illustrations may differ from what appears on the display on the actual equipment, and some of the illustrations on the display may represent something impossible in actual operation.
- The functions that can be used and the information that can be displayed will differ depending on the external disc players being connected.
- There is no image on the monitor at times other than DVD mode.

Cleaning the Faceplate Terminals

If the terminals on the unit or faceplate get dirty, wipe them with a dry, soft cloth.

Cleaning the Unit

If the faceplate of this unit is stained, wipe it with a dry soft cloth such as a silicon cloth. If the faceplate is stained badly, wipe the stain off with a cloth moistened with neutral cleaner, then wipe neutral detergent off.

▲ CAUTION

Applying spray cleaner directly to the unit may affect its mechanical parts. Wiping the faceplate with a hard cloth or using a volatile liquid such as thinner or alcohol may scratch the surface or erases characters.

Cleaning the Disc Slot

As dust can accumulate in the Disc slot, clean it occasionally. Your Discs can get scratched if you put them in a dusty Disc slot.

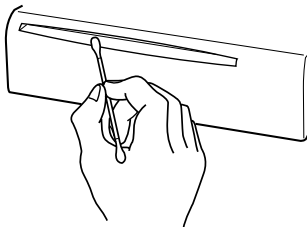

The marking of products using lasers (Except for some areas)

CLASS 1 LASER PRODUCT

The label is attached to the chassis/case and says that the component uses laser beams that have been classified as Class 1. It means that the unit is utilizing laser beams that are of a weaker class. There is no danger of hazardous radiation outside the unit.

Lens Fogging

Right after you turn on the car heater in cold weather, dew or condensation may form on the lens in the disc player of the unit. Called lens fogging, discs may be impossible to play. In such a situation, remove the disc and wait for the condensation to evaporate. If the unit still does not operate normally after a whilst, consult your Kenwood dealer.

Handling Discs

Playing a Disc that is dirty, scratched or warped can cause the sound to skip and the unit to operate incorrectly, resulting in worsened sound quality. Take the following precautions to prevent your Discs from getting scratched or damaged.

Handling Discs

- Do not touch the recorded side of the Disc (i.e., the side opposite the label) when holding it.

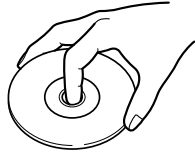

- Do not stick tape on either side of the disc.

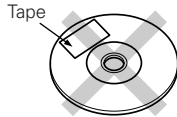

Storing Discs

- Do not store discs in areas exposed to direct sunlight – such as a car seat or above the fascia panel (dashboard) – or other hot places.
- Remove discs from the unit when not listening to them for a whilst, and put them back in their cases. Do not stack discs that have been removed from their cases or prop them against something.

Cleaning Discs

If a disc has become dirty, wipe it off gently using a commercially available cleaning cloth or a soft cotton cloth, starting from the centre of the disc and moving outward. Do not clean discs with conventional record cleaners, anti- static formulas, or chemicals such as paint thinner or benzene.

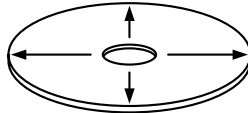

Checking New Discs for Burrs

When playing a new disc for the first time, check that there are not any burrs stuck to the perimeter of the disc or in the central hole. Discs with burrs stuck on them may not load properly or may skip whilst playing. Remove burrs using a ballpoint pen or a similar utensil.

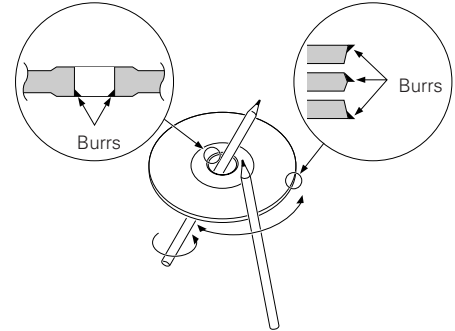

Do Not Load CD Accessories in Slot

Do not use commercially available CD accessories that can be loaded into the disc slot, such as stabilisers, protective sheets, or CD cleaning discs, since they can cause the unit to malfunction.

Removing the Disc

Only remove the disc from the machine in a horizontal direction. You may damage the surface of the disc if you try pulling it down as it ejects.

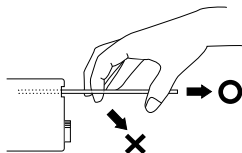

Do Not Use Special Shape Discs

- Be sure to use round shape Discs only for this unit and do not use any special shape Discs. Use of special shape Discs may cause the unit to malfunction.





Do Not Use Discs with Sticker on the Labelled Side

Do not use the disc with the label sticker stuck on it.

Using such a disc may cause the disc to be deformed and the sticker to peel off, resulting in malfunction of the unit.

Before Use

This player has been designed to play back the DVD software which has been encoded for specific region areas. It cannot play back the DVD software encoded for other region areas than the region areas for which it has been designed.

The Z920DVD will playback any disc whose region number is (or  

Restrictions due to difference between discs

Inhibition icon  Some DVD and VCD discs can be played only in certain playback modes according to the intentions of the software producers. As this player plays discs according to their intentions, some functions may not work as intended by you. Please be sure to read the instructions provided with each disc. When an inhibition icon is displayed on the monitor, it indicates that the disc being played is under the restriction as described above.





Unplayable discs

This player cannot play back any of the following discs.

- MP3 recorded CD
- DVD-ROM discs
- SVCD/HQVCD discs
- DVD-R/DVD-RW/DVD-RAM discs
- VSD discs
- CDV discs (Only the audio part can be reproduced.)
- CD-G/CD-EG/CD-EXTRA discs (Only the audio can be reproduced.)
- Photo CD discs (Never attempt to play them.)
- CD-R / RW discs

Use PAL discs in this player.

Icons on the DVD discs

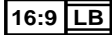
Icon	Description
	Indicates the region code where the disc can be played.
	Number of voice languages recorded with the audio function. The number in the icon indicates the number of voice languages. (Max. 8 languages)
	Number of subtitle languages recorded with the subtitle function. The number in the icon indicates the number of subtitle languages. (Max. 32 languages)
	Number of angles provided by the angle function. The number in the icon indicates the number of angles. (Max. 9 angles)
	Aspect ratios that can be selected. "LB" stands for Letter Box and "PS" for Pan/Scan. In the example on the left, the 16:9 video can be converted into letter box video.

Glossary

DVD: Digital Versatile Disc

A type of disc which contains recording of audio/video packaged media with high video and audio quality, such as a movie, featuring large recording capacity and digital signal processing capability.

VIDEO CD (VCD)

A type of CD which contains the recording of moving images. It compresses image information by about 1/120 and audio information by about 1/6 and accommodates up to 74 minutes of recording in a disc with the same diameter as ordinary music CD of 12 cm.

Some VCDs do not have the P.B.C. compatibility and are capable of

playback only, while some are P.B.C.-compatible and are capable of various special playback control operations. This player can play both of these VCDs.

MPEG: Moving Picture Expert Group (DVD, VCD)

This is an international standard for digital video and audio compression and decompression in media.

Dolby Digital

This is a digital audio compression technology developed by Dolby Laboratories. It is compatible with 5.1-channel surround audio as well as normal stereo (2-channel) audio and can accommodate a large amount of audio data efficiently in a disc.

DTS

Name of a digital surround system developed by Digital Theater Systems, Inc.

Top menu/menu (DVD)

Some DVDs display more than one title in a screen. This screen is referred to as the title menu.

The DVD menu is the item display (menu screen) for use in setting operations. The DVD menu can be recalled any time during playback to perform settings according to the current software, including the audio switching between Dolby Digital and PCM, switching of language used in the subtitles and spoken voice.

Title number (DVD)

The title is the largest unit of video and audio recorded in a DVD. It usually corresponds to a single movie of video software or an album (sometimes a piece of music) of music software. The numbers assigned to individual titles are referred to as the title numbers.

Chapter number (DVD)

The chapter is a section of video and audio recorded in a DVD. A title is composed of several chapters. The numbers assigned to individual chapters are referred to as the chapter numbers.

Subtitles (DVD)

Some DVD discs contains the recording of more than one subtitle language. This player allow you to select one of the recorded subtitle languages during playback.

Track number (CD, VCD)

A track is also a section of video and audio recorded in a disc. The numbers assigned to individual tracks are referred to as the track numbers.

With most of music Discs, a track is assigned to a piece of music. However, with a VCD, the sections of the contents do not always correspond to the assigned tracks.

As (special) playback functions such as skipping and programming of ordinary Discs are based on track number data, such playback functions are sometimes impossible with some VCDs.

P.B.C.: Play-Back Control (VCD)

When a VIDEO CD carries "Play Back Control capable" or similar message on the disc or jacket, desired scenes and information can be played back in an interactive manner using a hierarchical structure while viewing the menu screens displayed on the TV screen.

Certain audio features of this product manufactured under a license from Desper Products, inc. Spatializer® and the circle-in-square device are trademarks owned by Desper Products, inc.

This product incorporates copyright protection technology that is protected by method claims of certain U.S. patents and other intellectual property rights owned by Macrovision Corporation and other rights owners. Use of this copyright protection technology must be authorized by Macrovision Corporation, and is intended for home and other limited viewing uses only unless otherwise authorized by Macrovision Corporation. Reverse engineering or disassembly is prohibited.

Manufactured under license from Dolby Laboratories. "Dolby" and the double-D symbol are trademarks of Dolby Laboratories. Confidential Unpublished Works. ©1992-1997 Dolby Laboratories, Inc. All rights reserved.

"DTS" and "DTS Digital Out" are trademarks of Digital Theater Systems, inc.

General features

Release button

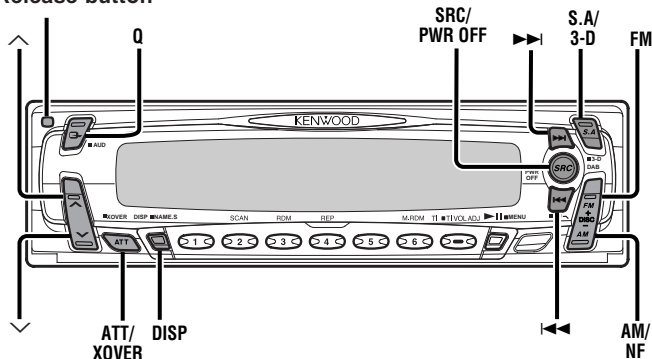

LOUD indicator

Description about this indicator for these features can be displayed by setting the Lower Part Display (page 14) to "... + Function indicator".

Power

Turning on the power:

Press the SRC button.

NOTE

Turn the power on before carrying out the following procedures.

Turning off the power:

Hold down the PWR OFF button for one second or more.

NOTE

The status of the Code Security Function (page 54) is displayed whenever the power is switched on.

"CODE ON" : Security Code has been registered

"CODE OFF" : Security Code has not been registered

Volume

Increasing Volume:

Press the ^ button to turn up the volume.

Decreasing Volume:

Press the v button to turn down the volume.

Attenuator

This function allows you to turn down the volume quickly.

Turning Attenuator On/Off:

Press the ATT button to switch the attenuator on and off. When the attenuator is off, the volume returns to the original level.

NOTE

Turning the volume up, or turning it all the way down deactivates the attenuator function.

Switching Modes

Switching Modes:

Each time you press the SRC button, the mode switches as follows:

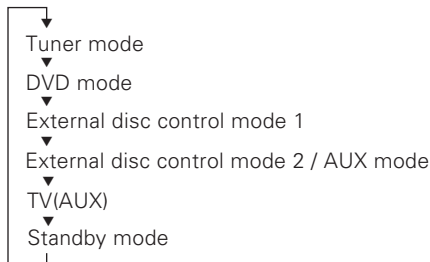

Selecting the standby mode:

Press the SRC button repeatedly to select to "ALL OFF". When "ALL OFF" is displayed, the standby mode is turned on. The standby mode turns all functions off although leaving the unit's power on. Use this mode when you want to have the display illuminated but do not want to listen to anything.

NOTE

- The mode switches to the next mode from any mode which cannot be used.
- The external disc control mode will differ depending on the unit that is connected.
- You cannot use the AUX input function of the optional switching adapter KCA-S210A if this unit is connected with the KCA-S210A.
- If you have selected Standby mode, the timer function that turns the power off automatically will be activated. To find out how to set the time on the timer, and how to cancel the timer function, refer to the section on the Power OFF Timer function under Menu settings (page 60). The Power OFF Timer function is enabled only after the security code (page 54) is set up.

NOTE

Selecting AUX-name display

Holding down the DISP button for two seconds or more during the AUX mode, AUX-name display is blinked for AUX-name selection mode.

Pressing ◀◀ or ▶▶ button during this mode allows you to select "TV", "VIDEO", "GAME", "PORTABLE" or "AUX" in the AUX mode.

The AUX-name selection mode can be exited by pressing the DISP button or doing nothing for 10 seconds.

General features

Switching Display Mode

You can select the display mode of this unit.

Changing the Display Mode:

Each time you press the DISP button, the display mode switches as follows:

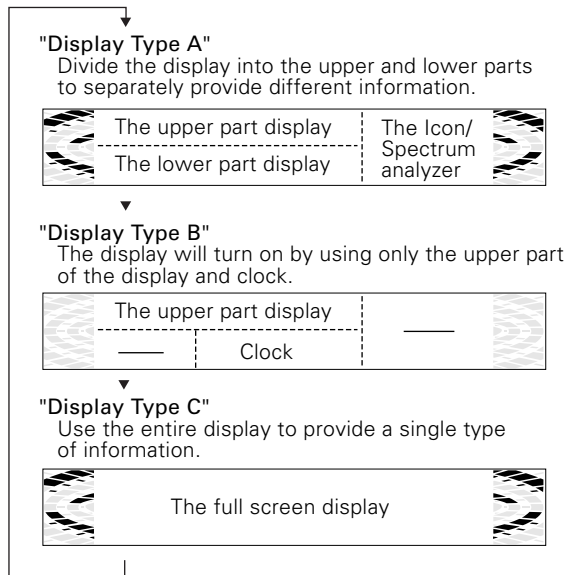

NOTE

- You can switch display information between the upper part display, lower part display, and full screen display. For further information, see "Switching the Upper Part Display" (page 12), "Switching the Lower Part Display" (page 14), "Switching Full-Screen Display" (page 15) respectively.
- You can switch the Icon/Spectrum analyzer.

See "Icon/Spectrum analyzer Select" in the menu setting (page 57).

- You cannot switch into the "Display Type C" during the standby mode.

Switching the Upper Part Display

This function switches the type of information on the upper part display when the display mode is "Display Type A" or "Display Type B".

- Press the S.A button to enter the display control mode.
- Each time you press the ◀◀ or ▶▶ button, the upper part display changes as follows:

In Tuner mode:

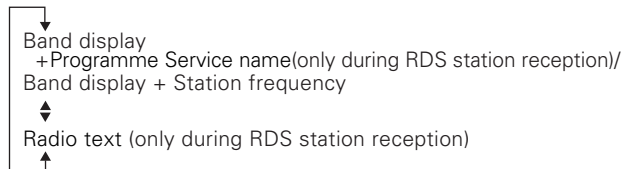

Displaying Frequencies:

Hold down the DISP button for one second or more. The frequency for the RDS station will be displayed for five seconds instead of the station name.

NOTE

If the RDS station currently tuned to is transmitting no text whilst the Radio Text Display mode is turned on, "NO TEXT" will appear in the display. Whilst awaiting reception, "Waiting" will be displayed.

WARNING

To prevent accidents, drivers should not look at the display whilst driving.

In External disc control mode:

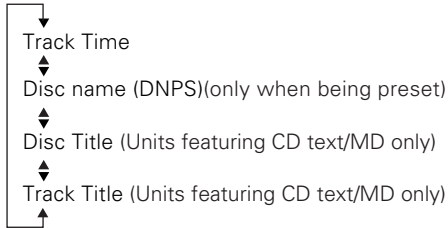

NOTE

- You can give names to discs through the presetting disc name function (page 50). Note that depending on the unit, display may not be possible.
- If you try to display the name of a disc that does not have one, "NO NAME" is displayed instead.
- When there is an attempt to display the title of a disc for which the disc title/track title has not been recorded, "NO TEXT" is displayed for CD and "NO TITLE" is displayed for MD.
- Depending on the type of characters of the CD Text, some characters may not be displayable.

3 Press the S.A button to end the display control mode.

NOTE

- For display mode selection, see "Switching display mode" (page 12).
- The same items cannot be selected for both the upper part and the lower part.
- In DVD mode and AUX mode, the Upper Part Display is only the fixed display for each media DVD, VCD, and CD, and the AUX-name. It can't be switched.

General features

Switching the Lower Part Display

This function switches the type of information on the lower part display when the display mode is "Display Type A".

- 1 Press the S.A button to enter the display control mode.
- 2 Each time you press the FM or AM button, the lower part display changes as follows:

In Tuner mode:

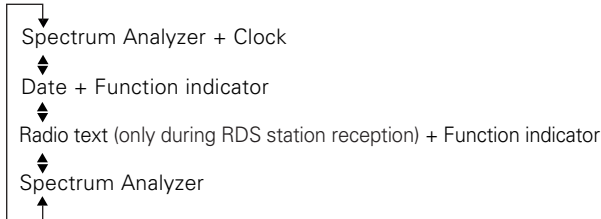

NOTE

If the RDS station currently tuned to is transmitting no text whilst the Radio Text Display mode is turned on, "NO TEXT" will appear in the display. Whilst awaiting reception, "Waiting" will be displayed.

WARNING

To prevent accidents, drivers should not look at the display whilst driving.

In DVD mode:

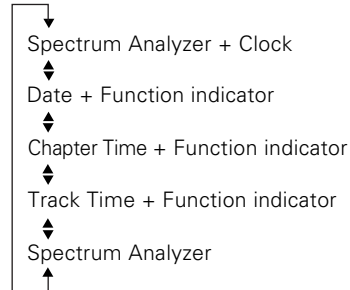

In VCD/CD mode:

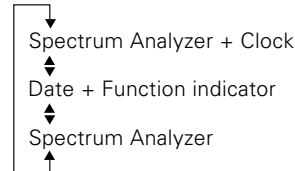

In External disc control mode:

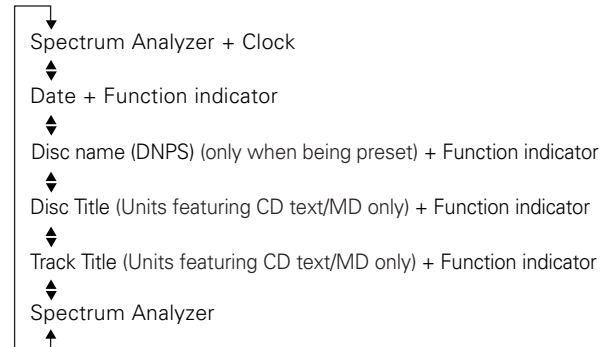

NOTE

- You can give names to discs through the presetting disc name function (page 50).
Note that depending on the unit, display may not be possible.
- If you try to display the name of a disc that does not have one, "NO NAME" is displayed instead.
- When there is an attempt to display the title of a disc for which the disc title/track title has not been recorded, "NO TEXT" is displayed for CD and "NO TITLE" is displayed for MD.
- Depending on the type of characters of the CD Text, some characters may not be displayable.

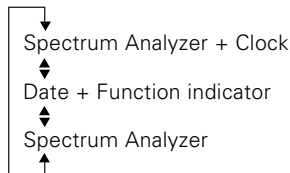
In AUX mode:

3 Press the S.A button to end the display control mode.

NOTE

- For display mode selection, see "Switching display mode" (page 12).
- If the display mode is set to "Display Type B", you can turn on or turn off the clock.
- The same items cannot be selected for both the upper part and the lower part.

Switching Full-Screen Display

This function switches the type of information on the display when the display mode is "Display Type C".

Each time you press the S.A button, the full screen display changes as follows:

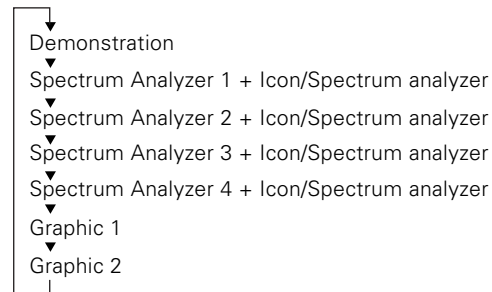
**NOTE**

- For display mode selection, see "Switching display mode" (page 12).
- You can switch the Icon/Spectrum analyzer.
See "Icon/Spectrum analyzer Select" in the menu setting (page 57).

General features

Switching Display during the Standby mode

This function switches the type of information on the display in standby mode.

- 1 Press the SRC button repeatedly to select the standby mode. "ALL OFF" is displayed when the standby mode is selected.
- 2 Each time you press the S.A button, the display changes as follows:

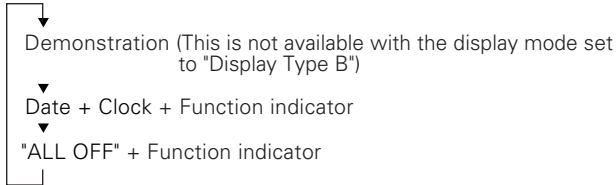

TEL Mute

Shut down the audio system temporarily whenever an incoming call is received.

NOTE

The function will not work if a cable is not connected to the car phone.

When the telephone rings:

When a call is received, "CALL" is displayed and all the unit functions are temporarily interrupted.

Restoring Original Unit Source During Phone Call:

Press the SRC button.

"CALL" disappears from the display, and the volume of the original source is restored gradually.

Turning TEL Mute Function Off After Phone Call:

Hang the phone up.

"CALL" disappears from the display.

The original source (i.e., the one used before the phone call) is returned to automatically, and the volume restored gradually.

Theft Deterrent Faceplate

The faceplate of the unit can be detached and taken with you, helping to deter theft.

Removing the Faceplate:

- 1 Press the release button and drop open the faceplate.
- 2 Holding the centre part of the faceplate, pull it out.

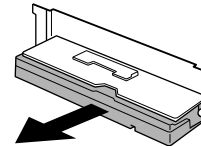

- 3 Push upward the back of the faceplate bracket until it locks.

CAUTION

Audio effect control features

<When the KDS-P901 is not connected>

- Do not apply excessive force to the faceplate bracket without attaching the faceplate. Doing so will cause the faceplate bracket to be deformed.
- Do not touch the connector on the faceplate bracket after removing the faceplate. Touching the connector may cause damage to the unit.

NOTE

- The faceplate is a precision piece of equipment and can be damaged by shocks or jolts. For that reason, keep the faceplate in its special storage case whilst detached.
- Do not expose the faceplate or its storage case to direct sunlight or excessive heat or humidity. Also avoid places with too much dust or the possibility of water splashing.

Reattaching the Faceplate:

- 1 Hold the faceplate so that the control panel faces the front toward you and set the left side of the faceplate in the faceplate bracket.

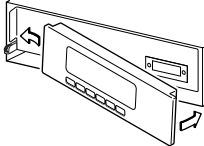

CAUTION

Do not set the right side of the faceplate in the faceplate bracket first, when reattaching the faceplate. Doing so may cause the connector on the faceplate bracket to malfunction.

- 2 Press the right side of the faceplate until it locks.

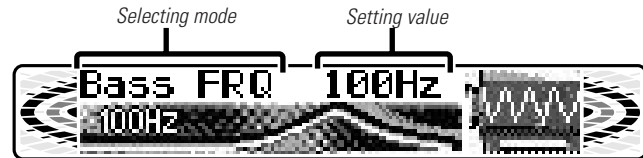
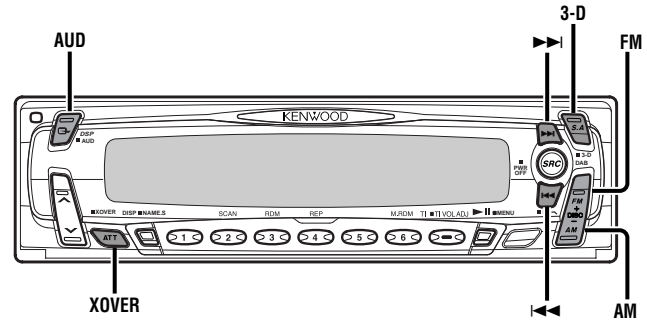

Audio effect control features

<When the KDS-P901 is not connected>

System Q

You can recall the best audio setting preset for different types of the music.

Switching the Preset Sound Setting:

Each time you press the Q button, the preset sound setting switches as follows:

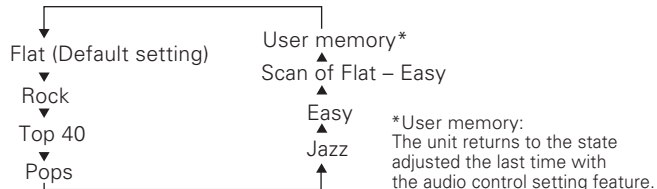

NOTE

The System Q function changes the values of the following sound quality parameters:
Bass centre frequency, bass level, bass quality factor, bass extend, middle centre frequency, middle level, middle quality factor, treble centre frequency, treble level.
Their setting values are different depending on the setting of the speaker setting mode. (page 18)

Speaker Setting

This function allows you to adjust the setting that is recalled with the System Q, according to types of speakers.

- 1 Press the SRC button repeatedly to select the standby mode. "ALL OFF" is displayed when the standby mode is selected.
- 2 Press the Q button to enter the speaker setting mode.
- 3 Press either the ◀◀ or ▶▶ button to select the type of speaker. The setting switches as follows.
Off ("Speaker Setting OFF") /
For the OEM speaker ("Speaker Setting O.E.M.") /
For 6x9/6 in. speaker ("Speaker Setting 6*9/6 inch") /
For 5/4 in. speaker ("Speaker Setting 5/4 inch") /
- 4 Press the Q button to end the speaker setting mode.

NOTE

Speaker setting function allows for tuning of bass, middle and treble

Non-Fading Output

You can turn the non-fading output on and off.

Turning non-fading output On/Off :

Hold down the NF button for one second or more to set the function ON or OFF.
"NF ON" is displayed when the non-fading output is set ON.

Audio Control Setting:

Adjust various parameters of sound quality.

1 Hold down the AUD button for one second or more to enter the control mode.

2 **Selecting mode**

Press either the FM or AM button.

Each time the button is pressed, the adjustment mode will change.

Please refer to the following for the contents of the adjustment modes.(Items 1-13 can be adjusted in this Adjustment mode.)

NOTE Source tone memory

Each source (DVD, TV(AUX), FM, AM, and external disc) has its own memory in which to store the bass, middle, treble and N-F level settings.

The settings made for a particular source are then recalled automatically whenever you use that source (e.g., FM mode uses the tone settings made for FM, AM for AM, etc.).

3 **Adjust each mode**

Press the **I◀▶/▶▶** button.

Please refer to the following for the adjusting values.

4 Press the AUD button to end the control mode.

NOTE

- Determining the parameters in the audio control setting will clear all the adjustments made in the System Q and they are replaced with the values made in the audio control setting.
- The following parameters can be set when the System Q function on the menu settings is ON.
Bass centre frequency, bass quality factor, bass extend, middle centre frequency, middle quality factor, and treble centre frequency.

1. Bass Centre Frequency

Adjust the centre frequency of the bass.

Display and setting:

"Bass FRQ" : 60 / 70 / 80 / **100** (Only when the bass quality factor is set to 1.00, 1.25 or 1.50) / 150 (Only when the bass quality factor is set to 2.00) Hz.

2. Bass Level

Adjust the bass level.

Display and setting:

"Bass" : - 9 - **0** - + 9

3. Bass Quality Factor

Adjust the Bass quality factor.

Display and setting:

"Bass Q" : **1.00** / 1.25 / 1.50 / 2.00

4. Bass Extend

Switch the Bass Extend mode on/off.

Display and setting:

"Bass EXT" : ON / **OFF** (When the bass extend mode is set to on, low frequency response is extended by 20%.)

Audio effect control features

<When the KDS-P901 is not connected>

5.Middle Centre Frequency

Adjust the centre frequency of the middle.

Display and setting:

"MID FRQ" : 0.5 / **1.0** / 1.5 / 2.0 kHz.

6.Middle Level

Adjust the middle level.

Display and setting:

"MID" : -9 - **0** - +9

7.Middle Quality Factor

Adjust the middle quality factor.

Display and setting:

"MID Q" : **1.00** / 2.00

8.Treble Centre Frequency

Adjust the centre frequency of the treble.

Display and setting:

"TRE FRQ" : 10.0 / **12.5** / 15.0 / 17.5 kHz

9.Treble Level

Adjust the treble level.

Display and setting:

"TRE" : -9 - **0** - +9

10.Balance Level

Adjust the balance level.

Display and setting:

"Balance" : Left 15 - **0** - Right 15

11.Fader Level

Adjust the fader level.

Display and setting:

"Fader" : Rear 15 - **0** - Front 15

12.Non-Fading Level

Adjust the Non-fading output level.

Display and setting:

"NF Level" : -15 - **0** - +15

NOTE

This mode is available only when the non-fading output function is set to on.

13. Volume Offset

Set the sound level of the each source selected by adjusting the level difference between the basic sound level and the required level.

Display and setting:

"Volume Offset" : - 8 - ± 0

Crossover Network Control Setting:

Adjust various parameters of sound quality.

- 1** Hold down the XOVER button for one second or more to enter the control mode.
- 2 Selecting mode**
Press either the FM or AM button.
Each time the button is pressed, the adjustment mode will change.
Please refer to the following for the contents of the adjustment modes. (Items 1-4 can be adjusted in this Adjustment mode.)
- 3 Adjust each mode**
Press the ◀◀/▶▶ button.
Please refer to the following for the adjusting values.
- 4** Press the XOVER button for one second or more to end the control mode.

1.High-pass Filter Frequency for Front Output

Adjust the frequency of the High-pass filter for front output.

Display and setting:

"FRNT HPF" : **THROUGH** / 40Hz / 60Hz / 80Hz / 100Hz / 120Hz
/ 150Hz / 180Hz / 220Hz

NOTE

You can separately set the high-pass filter for front and rear output, including preouts. The high-pass filter does not affect the non-fading preout.

Audio effect control features

<When the KDS-P901 is not connected>

2.High-pass Filter Frequency for Rear Output

Adjust the frequency of the High-pass filter for rear output.

Display and setting:

"REAR HPF" : **THROUGH** / 40Hz / 60Hz / 80Hz / 100Hz / 120Hz
/ 150Hz / 180Hz / 220Hz

NOTE

You can separately set the high-pass filter for front and rear output, including preouts. The high-pass filter does not affect the non-fading preout.

3.Low-pass Filter Frequency for Non-Fading Output

Adjust the frequency of the Low-pass filter for Non-Fading output.

Display and setting:

"NF LPF" : 50 Hz / 80 Hz / 120 Hz / **THROUGH**

NOTE

This mode is available only when the non-fading output function is set to on.

4.Phase for Non-Fading Output

Adjust the phase for Non-Fading output.

Display and setting:

"NF Phase" : **Normal** (0°) / Reverse (180°)

NOTE

This mode is available only when the non-fading output function is set to on.

Spatializer® Function Setting:

You get a 3-D stereo effect when the Spatializer® function is turned ON.

- 1 Hold down the 3-D button for one second or more to enter the 3-D stereo control mode.
The **Spatializer®** function is turned on.
- 2 **Selecting mode**
Each time you press the 3-D button to switch the **Spatializer®** function as follows:
" **BYPASS** " / " **LOW** " / " **MID** " / " **HIGH** "
- 3 Press the 3-D button for one second or more to end the 3-D stereo control mode.

NOTE

If you make no button operation for 10 seconds, the 3-D stereo control mode is automatically canceled.

Turning the Spatializer® function Off:

- 1 Select the "BYPASS" mode.
- 2 Press the 3-D button for one second or more.

Audio effect control features

<When the KDS-P901 is connected>

Dual Zone System

The following operation allows separate sound sources to control the output of the front and rear speakers.

Setting the Dual Zone function:

Press the S.A button for at least one second to enter the Dual Zone System setup mode.

Each time you press the ►|| button, the mode switches as follows:

"ON" : The dual zone system function is on.

"OFF" : The dual zone system function is off.

Setting the Dual Zone Speaker:

You can select whether to output KDS-P901(AUX) sound from the rear or from the front.

Each time you press the FM or AM button, the mode switches as follows:

"Normal" : KDS-P901(AUX) sound send to the rear speaker.

"Reverse" : KDS-P901(AUX) sound send to the front speaker.

NOTE

This mode is available during the Dual zone system is on.

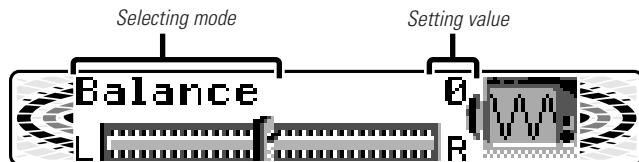

Audio effect control features

<When the KDS-P901 is connected>

Audio Control Setting:

Adjust various parameters of sound quality.

- 1 Hold down the AUD button for one second or more to enter the control mode.
- 2 **Selecting mode**
Press either the FM or AM button.
Each time the button is pressed, the adjustment mode will change.
Please refer to the following for the contents of the adjustment modes.(Items 1-4 can be adjusted in this Adjustment mode.)
- 3 **Adjust each mode**
Press the |◀◀/▶▶| button.
Please refer to the following for the adjusting values.
- 4 Press the AUD button to end the control mode.

1.Balance Level

Adjust the balance level.

Display and setting:

"Balance" : Left 15 – 0 – Right 15

2.Fader Level

Adjust the fader level.

Display and setting:

"Fader" : Rear 15 – 0 – Front 15

3.Sub Woofer Level

Adjust the Sub Woofer output level.

Display and setting:

"SW Level" : - 35 – 0 – + 5

NOTE

- Not available during the Dual zone system is on.
- You cannot operate when the "Sub Woofer" is set to "OFF" (page 29).

4.Volume Offset

Set the sound level of the each source selected by adjusting the level difference between the basic sound level and the required level.

Display and setting:

"Volume Offset" : - 8 – ± 0

Crossover Network Control Setting:

Adjust various parameters of sound quality.

- 1 Hold down the XOVER button for one second or more to enter the control mode.
- 2 **Selecting mode**
Press either the FM or AM button.
Each time the button is pressed, the adjustment mode will change.
Please refer to the following for the contents of the adjustment modes.(Items 1-12 can be adjusted in this Adjustment mode.)
- 3 **Adjust each mode**
Press the ◀▶ button.
Please refer to the following for the adjusting values.
- 4 Press the XOVER button for one second or more to end the control mode.

NOTE

Not available during the Dual zone system is on.

1.High-pass Filter for Front Output

Adjust the frequency of the High-pass filter for front output.

Display and setting the frequency:

"FRNT HPF" : **THROUGH** / 30Hz / 60Hz / 90Hz / 120Hz / 150Hz / 180Hz / 250Hz

Display and setting the slope:

"FRNT Slope" : **12dB** / 18dB / 24dB

NOTE

- You cannot operate when the "Sub Woofer" is set to "OFF" (page 29).
- The slope setting can't be adjusted when the frequency setting is THROUGH.

2.Delay Time for the Front Right Speaker

Adjust the delay time for front right output.

Display and setting:

"F-R DTA" : **0.0m** / 0.1m / 0.3m / 0.4m / 0.6m / 0.7m / 0.9m / 1.0m / 1.2m / 1.3m / 1.5m / 1.6m / 1.8m / 1.9m / 2.1m / 2.2m / 2.4m / 2.5m / 2.7m / 2.8m / 3.0m / 3.3m / 3.6m / 3.9m / 4.2m / 4.5m / 4.8m / 5.1m / 5.4m / 5.7m / 6.0m

3.Delay Time for the Front Left Speaker

Adjust the delay time for front left output.

Display and setting:

"F-L DTA" : **0.0m** / 0.1m / 0.3m / 0.4m / 0.6m / 0.7m / 0.9m / 1.0m / 1.2m / 1.3m / 1.5m / 1.6m / 1.8m / 1.9m / 2.1m / 2.2m / 2.4m / 2.5m / 2.7m / 2.8m / 3.0m / 3.3m / 3.6m / 3.9m / 4.2m / 4.5m / 4.8m / 5.1m / 5.4m / 5.7m / 6.0m

4.High-pass Filter for Rear Output

Adjust the frequency of the High-pass filter for rear output.

Display and setting the frequency:

"REAR HPF" : **THROUGH** / 30Hz / 60Hz / 90Hz / 120Hz / 150Hz / 180Hz / 250Hz

Display and setting the slope:

"REAR Slope" : **12dB** / 18dB / 24dB

NOTE

- You cannot operate when the "Sub Woofer" is set to "OFF" (page 29).
- You cannot operate when the "Multi CH" is set to "3/0" or "2/0" (page 29) <When playing with multi-channels>.
- The slope setting can't be adjusted when the frequency setting is THROUGH.

Audio effect control features

<When the KDS-P901 is connected>

5.Delay Time for the Rear Right Speaker

Adjust the delay time for rear right output.

Display and setting:

"R-R DTA" : 0.0m / 0.1m / 0.3m / 0.4m / 0.6m / 0.7m / 0.9m /
1.0m / 1.2m / 1.3m / 1.5m / 1.6m / 1.8m / 1.9m /
2.1m / 2.2m / 2.4m / 2.5m / 2.7m / 2.8m / 3.0m /
3.3m / 3.6m / 3.9m / 4.2m / 4.5m / 4.8m / 5.1m /
5.4m / 5.7m / 6.0m

NOTE

You cannot operate when the "Multi CH" is set to "3/0" or "2/0" (page 29) <When playing with multi-channels>.

6.Delay Time for the Rear Left Speaker

Adjust the delay time for rear left output.

Display and setting:

"R-L DTA" : 0.0m / 0.1m / 0.3m / 0.4m / 0.6m / 0.7m / 0.9m /
1.0m / 1.2m / 1.3m / 1.5m / 1.6m / 1.8m / 1.9m /
2.1m / 2.2m / 2.4m / 2.5m / 2.7m / 2.8m / 3.0m /
3.3m / 3.6m / 3.9m / 4.2m / 4.5m / 4.8m / 5.1m /
5.4m / 5.7m / 6.0m

NOTE

You cannot operate when the "Multi CH" is set to "3/0" or "2/0" (page 29) <When playing with multi-channels>.

7.Low-pass Filter for Sub Woofer Output

Adjust the frequency of the Low-pass filter for Sub Woofer output.

Display and setting the frequency:

"SW LPF" : 30Hz / 60Hz / 90Hz / 120Hz / 150Hz / 180Hz /
250Hz

Display and setting the slope:

"SW Slope" : 12dB / 18dB / 24dB

NOTE

You cannot operate when the "Sub Woofer" is set to "OFF" (page 29).

8.Delay Time for the Sub Woofer

Adjust the delay time for sub woofer output.

Display and setting:

"SW DTA" : 0.0m / 0.1m / 0.3m / 0.4m / 0.6m / 0.7m / 0.9m /
1.0m / 1.2m / 1.3m / 1.5m / 1.6m / 1.8m / 1.9m /
2.1m / 2.2m / 2.4m / 2.5m / 2.7m / 2.8m / 3.0m /
3.3m / 3.6m / 3.9m / 4.2m / 4.5m / 4.8m / 5.1m /
5.4m / 5.7m / 6.0m

NOTE

• You cannot operate when the "Sub Woofer" is set to "OFF" (page.29).

9.High-pass Filter for Centre Output

Adjust the frequency of the High-pass filter for Centre output.

Display and setting the frequency:

"CNTR HPF" : THROUGH / 30Hz / 60Hz / 90Hz / 120Hz / 150Hz
/ 180Hz / 250Hz

Display and setting the slope:

"CNTR Slope" : 12dB / 18dB / 24dB

NOTE

- You cannot operate when the "Sub Woofer" is set to "OFF" (page 29).
- You cannot operate when the "PCM Center" is set to "OFF" (page 29) <When playing with the 2ch PCM signal>.
- You cannot operate when the "Multi CH" is set to "2/2" or "2/0" (page 29) <When playing with multi-channels>.

10.Delay Time for the Centre Speaker

Adjust the delay time for centre output.

Display and setting:

"CNTR DTA" : 0.0m / 0.1m / 0.3m / 0.4m / 0.6m / 0.7m / 0.9m /
1.0m / 1.2m / 1.3m / 1.5m

NOTE

- You cannot operate when the "PCM Center" is set to "OFF" (page 29) <When playing with the 2ch PCM signal>.
- You cannot operate when the "Multi CH" is set to "2/2" or "2/0" (page 29) <When playing with multi-channels>.

11.Phase for Sub Woofer Output

Adjust the phase for Sub Woofer output.

Display and setting:

"SW Phase" : Normal (0°) / Reverse (180°)

NOTE

You cannot operate when the "Sub Woofer" is set to "OFF" (page.29).

12.Storing Your Setting of the Crossover network/Delay time

Press the #1 - #6 button for at least two seconds.

Recalling your settings of the Crossover network/Delay time

Press the #1 - #6 button for the desired crossover network and delay time setting.

Surround Processor Control Setting:

Adjust various parameters of sound quality.

1 Hold down the Q button to enter the control mode.

2 Selecting mode

Press either the FM or AM button.

Each time the button is pressed, the adjustment mode will change.

Please refer to the following for the contents of the adjustment modes.(Items 1-11 can be adjusted in this Adjustment mode.)

3 Adjust each mode

Press the ◀◀/▶▶ button.

Please refer to the following for the adjusting values.

4 Press the Q button to end the control mode.

NOTE

When the Noise sequencer is turned ON, only item 11 can be adjusted.

1.Recalling the Kenwood Preset Sound

You can recall the best audio setting preset for different types of the music.

Display and Setting:

"FLAT" / "POPS" / "ROCK" / "DANCE" / "VOCAL" /
"CLASSIC".

NOTE

- "User" displays each item when it's adjusted.
- Not available during the Dual zone system is on.

Audio effect control features

<When the KDS-P901 is connected>

2. Parametric Equalizer

Each time you press the FM or AM button, the adjustment mode will be switched as follows:

"BAND-1 f" / "BAND-1 Gain" / "BAND-1 Q" / "BAND-2 f" / "BAND-2 Gain" / "BAND-2 Q" / "BAND-3 f" / "BAND-3 Gain" / "BAND-3 Q" / "BAND-4 f" / "BAND-4 Gain" / "BAND-4 Q"

Adjusting the Centre Frequency:

Display and Setting:

"BAND-1 f" : 60Hz/ 80Hz/ **100Hz**/ 120Hz/ 160Hz/ 200Hz/ 250Hz
 "BAND-2 f" : 315Hz/ 400Hz/ **500Hz**/ 630Hz/ 800Hz/ 1kHz
 "BAND-3 f" : 1.25kHz/ 1.6kHz/ **2kHz**/ 2.5kHz/ 3.15kHz/ 4kHz
 "BAND-4 f" : 5kHz/ 6.3kHz/ 8kHz/ **10kHz**/ 12.5kHz/ 16kHz

Adjusting the Gain:

Display and Setting:

"BAND-1 Gain" : -12 - **0** - +12
 "BAND-2 Gain" : -12 - **0** - +12
 "BAND-3 Gain" : -12 - **0** - +12
 "BAND-4 Gain" : -12 - **0** - +12

Adjusting the Quality Factor:

Display and Setting:

"BAND-1 Q" : 0.25 / 0.50 / **1.00** / 2.00
 "BAND-2 Q" : 0.25 / 0.50 / **1.00** / 2.00
 "BAND-3 Q" : 0.25 / 0.50 / **1.00** / 2.00
 "BAND-4 Q" : 0.25 / 0.50 / **1.00** / 2.00

NOTE

- Not available during the Dual zone system is on.
- There is no equalizer effect in the centre speaker and Sub Woofer output.

3. Storing Your Setting of the parametric equalizer

Press the #1 - #3 button for at least two seconds.

Recalling your settings of the parametric equalizer

Press the #1 - #3 button for the desired the parametric equalizer setting.

NOTE

Not available during the Dual zone system is on.

4. Selecting the Position Mode

Display and Setting:

"POSITION ALL" / "POSITION F-LEFT" / "POSITION F-RIGHT" / "POSITION F-ALL" / "POSITION R-ALL"

"POSITION ALL" : Centre of the passenger cabin
 "POSITION F-LEFT" : Centred on the front left seat
 "POSITION F-RIGHT" : Centred on the front right seat
 "POSITION F-ALL" : Centred on the front seat
 "POSITION R-ALL" : Centred on the rear seat

NOTE

Not available during the Dual zone system is on.

5. Using the DOLBY PRO LOGIC

Dolby Pro Logic is a technology developed by Dolby Laboratories for the active decoding of Dolby Surround encoded source.

Display and Setting:

"Dolby PL ON" / "Dolby PL OFF"

NOTE

- Not available during the Dual zone system is on.
- You cannot operate Dolby Digital 5.1ch surround or DTS 5.1ch surround DVD and DTS-CD are playing.

6. Selecting the Acoustic Image

Display and Setting:

"Bi Phantom ON" / "Bi Phantom OFF"

NOTE

- You cannot operate when "Dolby PL" is set to "OFF".
- Not available during the Dual zone system is on.
- You cannot operate when Dolby Digital 5.1ch surround or DTS 5.1ch surround DVD and DTS-CD are being played.

7. Turning the Centre Output On/Off

Display and Setting:

"PCM center ON" / "PCM center OFF"

NOTE

- This select can be set, when the "Dolby PL" is turned OFF by the 2ch PCM signal
- Not available during the Dual zone system is on.

8. Selecting the Multi Channel

Select the sound output speaker for Multi channel sound.

Display and Setting:

"Multi CH 3/2" / "Multi CH 2/2" / "Multi CH 3/0" / "Multi CH 2/0"

"Multi CH 3/2" : Centre, Front and Rear speaker

"Multi CH 2/2" : Front and Rear speaker

"Multi CH 3/0" : Centre and Front speaker

"Multi CH 2/0" : Front speaker only

NOTE

- Not available during the Dual zone system is on.
- You cannot operate when "Dolby PL" is set "OFF" by 2ch PCM DVD, VCD or CD play, and other than in DVD mode.
- The setting may be invalid according to the disc signal format.

9. Turning the Sub Woofer Output On/Off

Display and Setting:

"Sub Woofer ON" / "Sub Woofer OFF"

NOTE

Not available during the Dual zone system is on.

Audio effect control features

<When the KDS-P901 is connected>

10. Setting the Channel Balance

This item allows you to adjust the output level of each channels of speaker using the built-in test signal. The output level must be adjusted from the listening position. The factory setup is "0 dB" for all types of speakers.

Test Signal:

Each time you press the ►|| button to switch the noise sequencer on and off.

NOTE

Not available during the Dual zone system is on.

Adjusting the Front Right Speaker:

"CH LEV F-R" : -10dB – 0 – +10dB

Adjusting the Front Left Speaker:

"CH LEV F-L" : -10dB – 0 – +10dB

Adjusting the Rear Right Speaker:

"CH LEV R-R" : -10dB – 0 – +10dB

Adjusting the Rear Left Speaker:

"CH LEV R-L" : -10dB – 0 – +10dB

NOTE

You cannot operate when the "Multi CH" is set to "3/0" or "2/0" (page 29) <When playing with multi-channels>.

Adjusting the Center Speaker:

"CH LEV CEN" : -10dB – 0 – +10dB

NOTE

- You cannot operate when the "PCM Center" is set to "OFF" (page 29) <When playing with the 2ch PCM signal>.
- You cannot operate when the "Multi CH" is set to "2/2" or "2/0" (page 29).
- Not available during the Dual zone system is on.

Tuner features

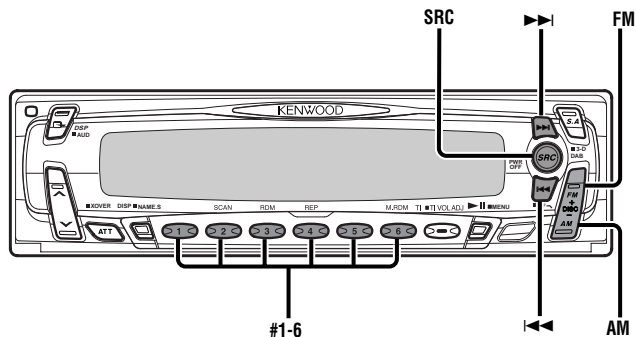

Tuning

- 1 Press the SRC button repeatedly until the tuner mode is selected. "TUNER" is displayed only when the tuner mode is selected.
- 2 Press either the FM or AM button to select the band. Each time you press the FM button, the band switches between the FM1, FM2 and FM3. Press the AM button to select the MW and LW bands.
- 3
 - Auto Seek Tuning
 - Press the ►►► button to seek increasing frequencies.
 - Press the ◄◄◄ button to seek decreasing frequencies.
 - Preset station seek tuning
 - Press the ►►► button to move to the next preset station (i.e., the one with the next highest number), and the ◄◄◄ button to move to the last preset station (i.e., the one with the next lowest number).

NOTE

If the frequencies stored at the preset numbers receive stations which were not originally memorized when travelling long distances, the preset number is not displayed. In such cases, pressing the ◄◄◄/►►► button to use preset station seek will receive channel 1.

- Manual Tuning
 - Press the ►►► button to increase the frequency by one step.
 - Press the ◄◄◄ button to decrease the frequency by one step.

NOTE

- The ST indicator lights up when stereo broadcasts are being received.
- Please see the menu settings about selecting tuning mode. (page 58)

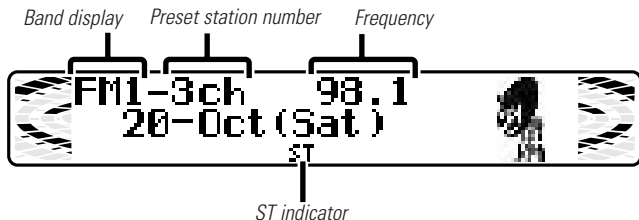

Description about this indicator for these features can be displayed by setting the Lower Part Display (page 14) to "... + Function indicator."

Tuner features

Direct Access Tuning *(Function of remote control)*

When you know the frequency of the station that you want to listen to, you can input it directly for quick access.

- 1 Select the band by pressing the FM or AM button.
- 2 Press the DIRECT button.
"----" is displayed for 10 seconds.
If you make no input in the 10-second period, direct access tuning is automatically cancelled.
- 3 Enter the frequency of the desired station.
If you want to listen to an FM station at 92.1 MHz, for example, press 0, 9, 2, and 1.
If you want to listen to an AM station at 810 kHz, for example, press 0, 8, 1, and 0.

NOTE

- You cannot enter frequencies above or below what a band can receive.
- FM frequencies can only be input in 0.1 MHz steps, and not 0.01 MHz steps.

Canceling Direct Access Tuning:

Press the DIRECT button again.

Station Preset Memory

Store the frequency of the station currently being listened to. You can then recall that station with a single touch of a button.

- 1 Select the band/station that you want to have stored.
- 2 Hold down the button (#1-6) that you want to use for the station, for two seconds or more.
The button number blinks once in the display to indicate that the data has been stored.

Recalling a Preset Station:

Press the preset station button (#1-6) for the desired station. The number of the recalled station is displayed.

NOTE

You can store 6 stations in each of the FM1, FM2, FM3, and AM (MW and LW) bands.

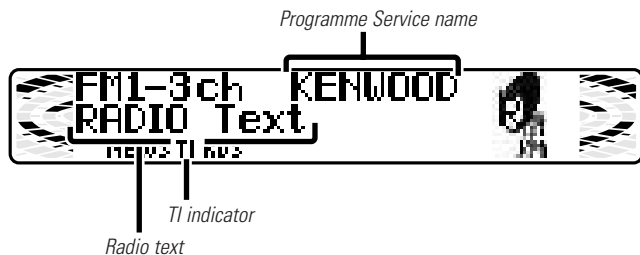
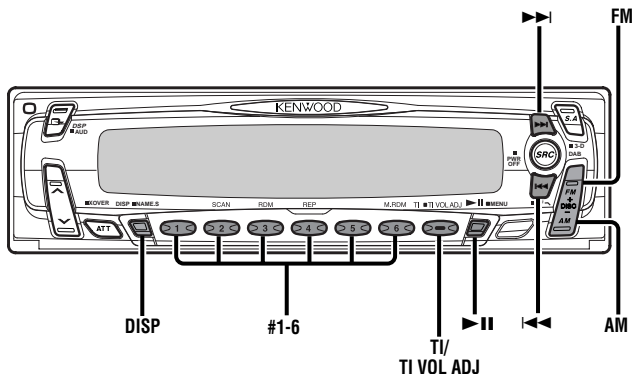

Description about this indicator for these features can be displayed by setting the Lower Part Display (page 14) to "... + Function indicator."

RDS (Radio Data System)

RDS is a digital information system that lets you receive signals besides those of regular radio programmes, such as network information being transmitted from radio stations. When listening to an RDS station (ie, a station with RDS capability), the programme service name of the station is displayed along with the frequency, advising you quickly which station is being received.

RDS (Radio Data System) stations also transmit frequency data for the same station. When you are making long trips, this function automatically switches to the particular frequency with the best reception for the particular network of stations that you want to listen to. The data is automatically stored, allowing you to switch quickly to another RDS stations, broadcasting the same programme, that has better reception. These include stations stored in the station preset memory that you often listen to.

Enhanced Other Network

Stations that offer <Enhanced Other Network> also transmit information about other RDS stations that have traffic information. When you are tuned to a station that is not transmitting traffic information, but another RDS station starts transmitting a traffic bulletin, the tuner automatically switches to the other station for the duration of the bulletin.

Alarm

When an emergency transmission (announcing disasters, etc.) is sent, all current functions are interrupted to allow the warning to be received.

RDS features

Traffic Information Function

You can listen to traffic information. If you are listening to tapes or discs, they will continue playing until a traffic bulletin is broadcast.

Turning TI function On/Off:

Press the TI button to turn the function on and off.

When the function is on, the TI indicator is turned on.

When none is being received, the TI indicator will blink on and off. When a traffic information station is being received, the TI indicator will turn on.

When a traffic bulletin begins to be broadcast, "Traffic Info" will be displayed, and reception will begin at the preset volume.

If you are listening to a tape or disc when a traffic bulletin begins, they will automatically be turned off. When the bulletin ends or poor reception is experienced, the tape or disc will begin playing again.

NOTE

Pressing the TI button whilst in the MW/LW band automatically switches reception to the FM band. However, the MW/LW band is not returned to when the TI button is pressed again.

Switching to a Different Traffic Information Station:

Use the ◀◀ / ▶▶ buttons to make an auto seek of the TI stations in a certain band.

NOTE

- When you are listening to a tape or disc, you cannot change to another TI station.
- When the auto TP seek function is turned on and reception starts to weaken, the tuner automatically seeks traffic information stations with better reception.
- If you are tuned to a station that is not a traffic information station itself but which provides <Enhanced Other Network> services, you can still have traffic information received.
- Holding down the TI button for one second or more when the TI function is on in the disc mode results in a change to the programme service name or frequency display of the traffic information station for five seconds.

Presetting Volume for Traffic Information/News

Preset the volume level to be used for traffic information and news broadcasts.

- 1 Tune into the station for which you want to set the volume.
- 2 Adjust the volume to the desired level.
- 3 Hold down the TI VOL ADJ button for two seconds or more. The volume level blinks once in the display to indicate that the data has been stored. Future traffic information/news broadcasts are heard at the preset level.

NOTE

- The volume cannot be lowered by this function during tuner reception. The volume is only set when it is louder than the listening volume of the tuner.
- You can arrange only to listen to traffic information or news bulletins with at preset volume with the volume set at minimum.

Programme Type (PTY) Function

Conduct auto seek tuning only on those stations with selected kinds of programmes.

- 1 Press the ▶II(PTY) button. "PTY Select" is displayed, and the Programme Type Selection (PTY) Mode entered. If you make no key input in 30 seconds, the mode will automatically turn off.

NOTE

You cannot use this function whilst the traffic bulletin is received.

2 Select the type of programme to be received

- Press either the FM or AM button repeatedly until the type of programme you want to listen to. The selection includes:

<i>Speech</i>	<i>(All Speech)</i>
<i>Music</i>	<i>(All Music)</i>
1. News	(News)
2. Current Affairs	(Current Affairs)
3. Information	(Information)
4. Sports	(Sport)
5. Education	(Education)
6. Drama	(Drama)
7. Culture	(Cultures)
8. Science	(Science)
9. Varied	(Varied Speech)
10. Pop Music	(Pop Music)
11. Rock Music	(Rock Music)
12. Easy Listening Music	(Easy Listening M)
13. Light Classical	(Light Classic M)
14. Serious Classical	(Serious Classics)
15. Other Music	(Other Music)
16. Weather	(Weather & Metr)
17. Finance	(Finance)
18. Children's programmes	(Children's Prog)
19. Social Affairs	(Social Affairs)
20. Religion	(Religion)
21. Phone In	(Phone In)
22. Travel	(Travel & Touring)
23. Leisure	(Leisure & Hobby)
24. Jazz Music	(Jazz Music)
25. Country Music	(Country Music)
26. National Music	(National Music)
27. Oldies Music	(Oldies Music)
28. Folk Music	(Folk Music)
29. Documentary	(Documentary)
<i>(Speech.....1~9,16~23, 29, Music.....10~15, 24~28)</i>	

- You can select the type of programme directly by pressing a preset button. The buttons are factory-set to the following type of programmes:

- | | | |
|-----------------|----------------------|-----------|
| 1. <i>Music</i> | 2. <i>Speech</i> | 3. News |
| 4. Other Music | 5. Serious Classical | 6. Varied |

NOTE Changing the Preset Button Settings for Programme Type

After selecting the type of programme to be stored in a certain preset button, hold down that button for two seconds or more. The previously stored data for that button are erased and the new

programme type is stored.

3 Seeking the selected programme type

Press the ◀◀ or ▶▶ button to make a seek of frequencies with your selected type of programme.

The display blinks and the seek starts.

If your selected type of programme is found, the name of the station is displayed and the station is tuned into.

"PTY Found" is displayed for about 30 seconds.

If you make no key input in 30 seconds, the PTY selection mode will turn off automatically.

NOTE

If no programme can be found, "NO PTY" is displayed.

If you want to select another type of programme, repeat steps 2 and 3 above.

Switching to Other Stations with the Same Type of Programme:

When "PTY Found" is displayed, perform auto seek tuning.

The tuner scans for another station with the same type of programme.

Cancelling Programme Type Function During Its Operation:

Press the ▶|| (PTY) button.

RDS features

Changing Language for Programme Type(PTY) Function

Changing the display language to another language.

- 1 Press the ►|| (PTY) button. "PTY Select" is displayed, and the Programme Type Selection (PTY) Mode entered.
- 2 **Enter the Changing Language Mode**
Press the DISP button to enter the changing language mode.
- 3 **Changing the Display Language**
Press the FM or AM button. Each time the button is pressed, the display language will change as follows:

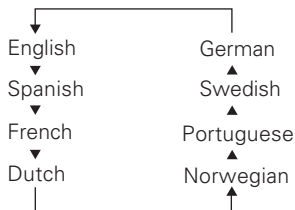

- 4 Press the DISP button to end the changing language mode.

Radio Text Scroll

This function permits the text to be scrolled and the entire text to be displayed. The scrolling method differs depending on the setting of scrolling in the menu.

To scroll manually:

- 1 Press the DISP button to display radio text on the upper part display, referring to "Switching the Upper Part Display" (page 12).
- 2 Holding down the DISP button for one second or more results in one scrolling display of the text.

To scroll automatically:

- 1 Display the radio text referring to the "Switching the Upper Part Display" (page 12) or "Switching the Lower Part Display" (page 14).
The text will be displayed in one scrolling display.
- 2 Holding down the DISP button for one second or more with radio text displayed on the upper part display scrolls the text once.

NOTE

- Please see the menu settings (page 60) about switching between manual scrolling and automatic scrolling.
- You can scroll text when "Display Type A" or "Display Type B" has been selected by the switching display mode function. For display mode selection, see "Switching display mode" (page 12).

DVD/VCD/CD control features

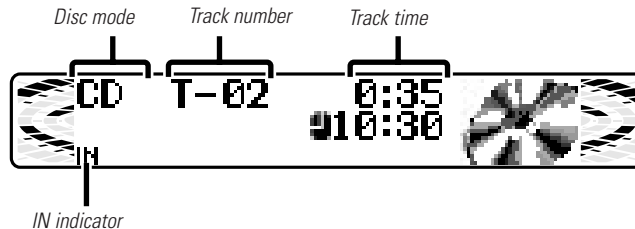
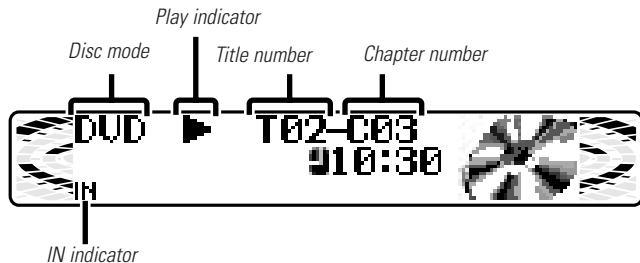
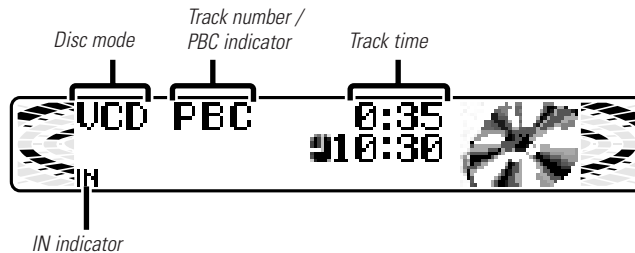
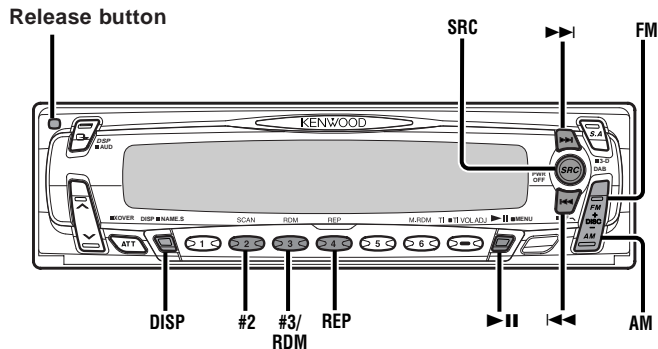

Description about this indicator for these features can be displayed by setting the Lower Part Display (page 14) to "... + Function indicator".

DVD/VCD/CD control features

Playing DVDs/VCDs/CDs

Playing DVDs/VCDs/CDs:

A press of the release button causes the faceplate to drop to the front, thereby exposing the DISC slot.

Holding the DISC with the labelled side facing up, insert it in the slot. The DISC will start playing.

Push back the faceplate with your hand until it locks.

The IN indicator will light when a DISC has been inserted.

▲CAUTION

When inserting a DISC, make sure the DISC has been completely drawn in before pushing back the faceplate. Failing to do so might scratch the DISC.

Playing DVDs/VCDs/CDs Already Inserted:

Press the SRC button repeatedly until the DVD mode is obtained.

"DVD" / "VCD" / "CD" is displayed when the DVD mode has been selected.

The DISC will start playing.

Pausing and Restarting DISC Play:

Press the ►|| button to make the disc pause.

Press the same button again to start play again.

Eject:

Press the release button and drop open the faceplate.

Press the ▲ button located near the DISC slot.

The DISC stops playing and ejects from the slot.

Push back the faceplate with your hand until it locks.

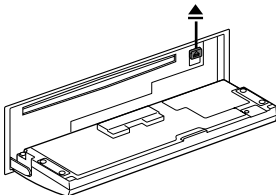

▲CAUTION

- Do not attempt to insert a DISC into the slot if another one is already there.

- The unit can only play 12-cm (5-inch) DISCs. If you insert an 8-cm (3-inch) DISC, it will get stuck inside and can cause the unit to malfunction.
- When the faceplate has been dropped open, it might interfere with the gear lever or something else. If this happens, pay attention to safety and move the gear lever or take an appropriate action, then operate the unit.
- Do not apply excessive force to the open faceplate or place objects on it. Doing so will cause damage or breakdown.
- Do not use the unit with the faceplate in the open condition. Doing so will cause breakdown.

NOTE

When you load a DISC and eject it right away, the next time you try to insert the DISC may not load. In such a situation, take the DISC out for a moment and then reinsert it.

Forward / Reverse Search Disc Play

Forward search:

Press the FM button.

Reverse search:

Press the AM button.

Cancelling Forward / Reverse search:

Press the ►|| button to play the disc at that point.

NOTE

- Each time you press, the search speed goes from 2 times(◀◀▶▶) to 3 times(◀◀◀▶▶▶).(DVD, VCD)
- When the 2x-speed Normal Sound Play function is ON, audio can only be output during 2x-speed.(DVD, VCD)
- The video may be disturbed during forward or reverse search.

Chapter Search (DVD)

Search forwards or backwards through the chapters on the disc until you reach the one that you want to look to.

Making a Forward Chapter Search:

Press the ►►| button once to fast forward to the next chapter, twice to fast forward to the chapter after that, and so forth.

Making a Reverse Chapter Search:

Press the |◄◄ button once to search back to the beginning of the current chapter, twice to search back to the beginning of the previous chapter, and so forth.

Track Search (VCD, CD)

(VCD:When the PBC function is set to [OFF])(page 64)

Search forwards or backwards through the tracks on the disc until you reach the one that you want to listen to.

Making a Forward Search

Press the ►►| button once to fast forward to the next track, twice to fast forward to the track after that, and so forth.

Making a Reverse Search

Press the |◄◄ button once to search back to the beginning of the current track, twice to search back to the beginning of the previous track, and so forth.

Next Play / Previous Play (VCD)

(When the PBC function is set to [ON])(page 64)

To Next Play

Press the ►►| button.

To Previous Play

Press the |◄◄ button.

Track Repeat (VCD, CD)

(VCD:When the PBC function is set to [OFF])(page 64)

Turning Repeat Play Function On/Off:

Press the REP button to switch the track repeat play function on and off.

NOTE

- Repeat play is canceled when you eject the disc.
- When Track Search is done when repeat is ON, repeat is released.

Pausing and Restarting Disc Play

Press the ►|| button to make the disc pause.

Press the ►|| button again to start play again

NOTE

The following operation may not be available with certain discs.

DVD/VCD/CD Setup Menu features

<Function of remote control >

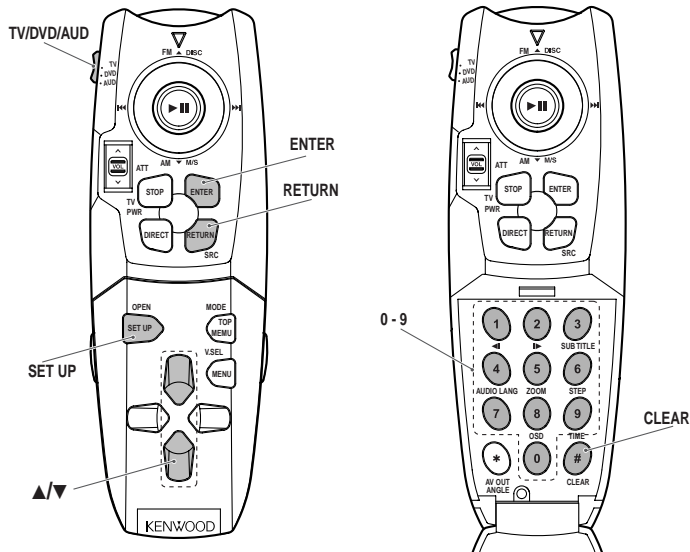

▶ TV/DVD/AUD button

Switching to the DVD position.



Selecting to the DVD Setup Menu

Press the SETUP button to switch to the DVD Setup Menu.

" **SETUP MENU** " :

- " **1 LANGUAGES** " (page 40)
- " **2 PARENTAL** " (page 44)
- " **3 AUDIO** " (page 45)
- " **4 PICTURE** " (page 46)

NOTE

Cannot be operated while the DVD/VCD/CD is being operated. If you want to change the setting, do it from the Remote control (page 61) in stop state.

Returning to the Previous menu

When the [RETURN] button is pressed during each item setting, it returns to the previous menu.

Ending in the Setup menu

When the [SET UP] button is pressed during each item setting, it ends in the Setup menu.

Setting the Priority Language for Voice

Set the audio language produced from the speakers.

- 1 Press the each the [▲ or ▼] buttons to select the "LANGUAGE".
Press the [ENTER] button.
- 2 Press the each the [▲ or ▼] buttons to select the "AUDIO".
Press the [ENTER] button.
- 3 Press the each the [▲ or ▼] buttons to select the language.
Press the [ENTER] button.

NOTE

- If the language isn't in the list, select "OTHER" and enter the "List of language codes" 4 digit code.
- If setting in the disc's original language, select "ORIGINAL."

Setting the Priority Language for Subtitle

Set the language of the subtitles displayed on the screen.

- 1 Press the each the [▲ or ▼] buttons to select the "LANGUAGE".
Press the [ENTER] button.
- 2 Press the each the [▲ or ▼] buttons to select the "SUBTITLE".
Press the [ENTER] button.
- 3 Press the each the [▲ or ▼] buttons to select the language.
Press the [ENTER] button.

NOTE

- If the language isn't in the list, select "OTHER" and enter the "List of language codes" 4 digit code.
- If you are making the subtitle language the same as the audio, select "AUTO."

Setting the Priority Language for Disc Menu

Set the language used for the menus (title menu, etc.).

- 1 Press the each the [▲ or ▼] buttons to select the "LANGUAGE".
Press the [ENTER] button.
- 2 Press the each the [▲ or ▼] buttons to select the "DISC MENU".
Press the [ENTER] button.
- 3 Press the each the [▲ or ▼] buttons to select the language.
Press the [ENTER] button.

NOTE

- If the language isn't in the list, select "OTHER" and enter the "List of language codes" 4 digit code.
- The selected language may not be on some discs as an initial language. If the selected language isn't recorded on the disc, the language set by the disc is selected.

List of language codes

Code	Language	Code	Language	Code	Language
6565	Afar	6983	Spanish	7473	Yiddish
6566	Abkhazian	6984	Estonian	7487	Javanese
6570	Afrikaans	6985	Basque	7565	Georgian
6577	Amharic	7065	Persian	7575	Kazakh
6582	Arabic	7073	Finnish	7576	Greenlandic
6583	Assamese	7074	Fiji	7577	Cambodian
6589	Aymara	7079	Faroese	7578	Kannada
6590	Azerbaijani	7082	French	7579	Korean
6665	Bashkir	7089	Frisian	7583	Kashmiri
6669	Byelorussian	7165	Irish	7585	Kurdish
6671	Bulgarian	7168	Scots Gaelic	7589	Kirghiz
6672	Bihari	7176	Galician	7665	Latin
6678	Bengali, Bangla	7178	Guarani	7678	Lingala
6679	Tibetan	7185	Gujarati	7679	Laotian
6682	Breton	7265	Hausa	7684	Lithuanian
6765	Catalan	7273	Hindi	7686	Latvian, Lettish
6779	Corsican	7282	Croatian	7771	Malagasy
6783	Czech	7285	Hungarian	7773	Maori
6789	Welsh	7289	Armenian	7775	Macedonian
6865	Danish	7365	Interlingua	7776	Malayalam
6869	German	7378	Indonesian	7778	Mongolian
6890	Bhutani	7383	Icelandic	7779	Moldavian
6976	Greek	7384	Italian	7782	Marathi
6978	English	7387	Hebrew	7783	Malay
6979	Esperanto	7465	Japanese	7784	Maltese

List of language codes

Code	Language	Code	Language	Code	Language
7789	Burmese	8385	Sundanese		
7865	Nauru	8386	Swedish		
7869	Nepali	8387	Swahili		
7876	Dutch	8465	Tamil		
7879	Norwegian	8469	Telugu		
7982	Oriya	8471	Tajik		
8065	Punjabi	8472	Thai		
8076	Polish	8473	Tigrinya		
8083	Pashto, Pushto	8475	Turkmen		
8084	Portuguese	8476	Tagalog		
8185	Quechua	8479	Tongan		
8277	Rhaeto-Romance	8482	Turkish		
8279	Romanian	8484	Tatar		
8285	Russian	8487	Twi		
8365	Sanskrit	8575	Ukrainian		
8368	Sindhi	8582	Urdu		
8372	Serbo-Croatian	8590	Uzbek		
8373	Singhalese	8673	Vietnamese		
8375	Slovak	8679	Volapuk		
8376	Slovenian	8779	Wolof		
8377	Samoan	8872	Xhosa		
8378	Shona	8979	Yoruba		
8379	Somali	9072	Chinese		
8381	Albanian	9085	Zulu		
8382	Serbian				

DVD/VCD/CD Setup Menu features

<Function of remote control >

Setting the Rating Level (parental lock)

Use this function to restrict the viewing of movies to children of appropriate age levels only.

Setting the password:

- 1 Press the each the [▲ or ▼] buttons to select the "PARENTAL"
Press the [ENTER] button.
- 2 Press the [1]-[0] button and enter your password (4-digit).
Input numbers are displayed " * ":

NOTE

- If you enter the wrong number, press the [CLEAR] button. The entered number is cleared.
 - The password's initial value is 7890.
 - If the password doesn't match, return to the "Setup Menu".
 - Pressing the Reset button erases the password.
- 3 Press the [ENTER] button.

Setting the Parental Level:

- 1 Press the each the [▲ or ▼] buttons to change the parental set level.
" UNLOCKED " (Default setting)
Cancelling the parental lock.
" 8 "
Plays any software (including adult-, general- and children-oriented).
" 7 " -" 2 "
Plays general- and children-oriented DVD software.
Restricts playback of adult-oriented DVD software.
" 1 "
Plays children-oriented software.
Restricts playback of adult and general-oriented DVD software.

NOTE

Parental level varies with the discs.

- 2 Press the [ENTER] button.

To change the password:

Select "Change Password" and enter a new 4 digit password.

NOTE

- Some discs may request that you change the rating level set in the default settings during playback. In this case, the rating level setup screen is displayed, if you do not input the correct password either playback does not continue or a picture for a different rating level is played.
- Write down the password on a piece of paper and store the piece of paper somewhere in case you forget it.
- On undated DVDs, playback will not be restricted even if the rating level is set.
- Once set, this rating level remains in memory until changed. To enable the play of discs of higher rating levels or to cancel the parental lock, the setting must be changed.
- Not all DVDs provide a Parental Lock feature. If you are unsure about a DVD, play it first to confirm. Do not leave DVDs accessible to young children for whom you deem them inappropriate.

Setting the Optical Output Mode (DIGITAL OUT)

Setting digital output type.

- 1 Press the each the [▲ or ▼] buttons to select the "AUDIO". Press the [ENTER] button.
- 2 Press the each the [▲ or ▼] buttons to select the "DIGITAL OUT". Press the [ENTER] button.
- 3 Each time you press the [▲ or ▼] buttons, the mode switches as follows:
" **STREAM** " (Default setting)
Select this when connected to an amp (decoder) that supports Dolby Digital.
" **LPCM** "
It's converted to a 48 KHz/16 bit linear PCM signal and output. Select this when connected to a device that doesn't support Dolby Digital.
" **OFF** "
Turns the digital output OFF.
- 4 Press the [ENTER] button.

Selecting the Dynamic Range Control (D.R.C)

- 1 Press the each the [▲ or ▼] buttons to select the "AUDIO". Press the [ENTER] button.
- 2 Press the each the [▲ or ▼] buttons to select the "D.R.C". Press the [ENTER] button.
- 3 Each time you press the [▲ or ▼] buttons, the mode switches as follows:
" **FULL** "
For the regular sound
" **STANDARD** " (Default setting)
For more powerful sound at regular volumes
" **NIGHT** "
For powerful sound at low volumes

NOTE

This select can be made when the Dolby Digital signal is inputed.

- 4 Press the [ENTER] button.

Setting the Audio During 2x Search

Setting the 2x-speed Normal Sound Play function.

- 1 Press the each the [▲ or ▼] buttons to select the "AUDIO". Press the [ENTER] button.
- 2 Press the each the [▲ or ▼] buttons to select the "AUDIO DURING*2". Press the [ENTER] button.
- 3 Each time you press the [▲ or ▼] buttons, the mode switches as follows:
" **ON** " (Default setting)
The 2x-speed Normal Sound Play function is ON.
" **OFF** "
The 2x-speed Normal Sound Play function is OFF.
- 4 Press the [ENTER] button.

DVD/VCD/CD Setup Menu features

<Function of remote control >

Setting the Screen Mode

Use the procedure described below to set the output screen.

- 1 Press the each the [▲ or ▼] buttons to select the "PICTURE".
Press the [ENTER] button.
- 2 Press the each the [▲ or ▼] buttons to select the "TV SCREEN".
Press the [ENTER] button.
- 3 Each time you press the [▲ or ▼] buttons, the mode switches as follows:
" **4:3 LETTERBOX** "
Wide-screen software with pan & scan specification is played in a letter box screen (with black stripes on the top and bottom).
" **4:3 PAN-SCAN** " (Default setting)
Wide-screen software with pan & scan specification is played in a panned & scanned screen (with the left and right sides cut off).
" **16:9 WIDE** "
Set the picture mode of the wide-screen monitor to "FULL"
- 4 Press the [ENTER] button.

Setting the Colour Scheme

Setting the On Screen Display colour.

- 1 Press the each the [▲ or ▼] buttons to select the "PICTURE".
Press the [ENTER] button.
- 2 Press the each the [▲ or ▼] buttons to select the "COLOR SCHEME".
Press the [ENTER] button.
- 3 Each time you press the [▲ or ▼] buttons, the mode switches as follows:
" **Yellow** "
The colour is yellow.
" **Green** "
The colour is green.
" **Blue** " (Default setting)
The colour is blue.
" **Red** "
The colour is red.
- 4 Press the [ENTER] button.

External disc control features

Setting the Zoom Setup

Setting the reference point when zooming and the amount of movement when scrolling.

- 1 Press the each the [▲ or ▼] buttons to select the "PICTURE"
Press the [ENTER] button.
- 2 Press the each the [▲ or ▼] buttons to select the "ZOOM SETUP"
Press the [ENTER] button.
- 3 Press the each the [▲ or ▼] buttons to select the "START POINT" or "PAN SCALE"
Press the [ENTER] button.

START POINT : Sets the reference point when zooming.

Each time you press the [▲ or ▼] buttons, the mode switches as follows:

" UPPER LEFT "

Zooms with the upper left as the reference point.

" CENTER " (Default setting)

Zooms with the screen center as the reference point.

" LAST POINT "

Zooms with the previous zoomed place as the reference point.

PAN SCALE : Sets the scroll amount.

Each time you press the [▲ or ▼] buttons, the mode switches as follows:

" NORMAL " (Default setting)

The scroll amount is normal.

" ROUGH "

The scroll amount is rough.

" FINE "

The scroll amount is fine.

- 4 Press the [ENTER] button.

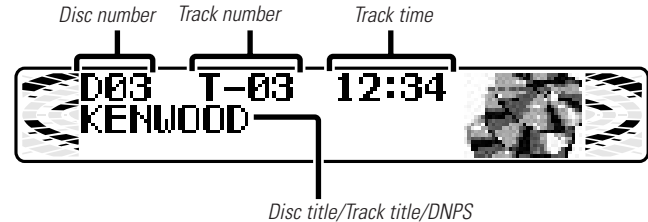
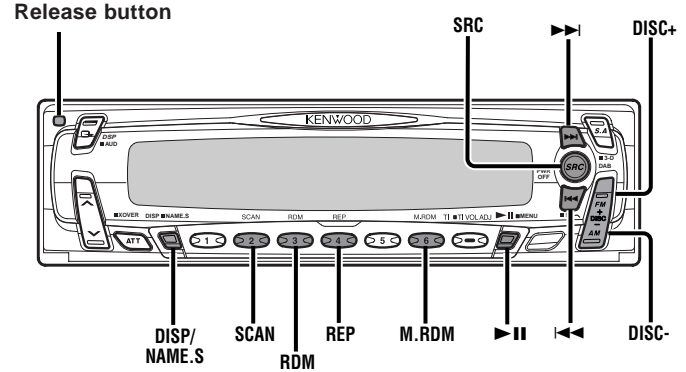

Description about this indicator for these features can be displayed by setting the Lower Part Display (page 14) to "... + Function indicator".

External disc control features

Playing Other Disc mode

This function permits the connection of optional players and the playing of discs other than the loaded DVD (in the current unit).

Playing Discs:

Press the SRC button repeatedly to select the external disc control mode.
The disc will start playing.

NOTE

- This unit can control as many as 2 units as an option.
- The external disc control mode will differ, depending on the unit that is connected.

Mode Display Examples

- "CD2"...when a CD player is connected
- "CD-CH"/"MD-CH"/"DISC"...when a disc changer is connected
- "CD-CH1"/"MD-CH1"/"DISC1", "CD-CH2"/"MD-CH2"/"DISC2"
...when two disc changers are connected

Pausing and Restarting Disc Play:

Press the **▶||** button to make the disc pause.
Press the same button again to start play again.

NOTE

When one disc has finished playing its last track, the next disc in the changer starts playing. When the last disc in the changer has finished, the player returns to the first disc and starts playing it.

Fast Forwarding and Reversing Disc Play

Fast Forwarding Disc Play:

Hold down on the **▶▶** button.
Release your finger to play the disc at that point.

Reversing Disc Play:

Hold down on the **◀◀** button.
Release your finger to play the disc at the point.

NOTE

You cannot use reverse play between tracks depending on the model being connected. Instead, the reverse play function is cancelled when it reaches the beginning of a track, at which point normal play automatically resumes.

Track Search

Search forwards or backwards through the tracks on the disc until you reach the one that you want to listen to.

Making a Reverse Track Search:

Press the **◀◀** button to display the desired track number.
Press once to search back to the beginning of the current track, twice to search back to the beginning of the previous track, and so forth.
Play starts at the beginning of the displayed track number.

NOTE (For disc changers)

Pressing the **◀◀** button whilst listening to track 1 only searches back to the beginning of that track. The reverse search is not "recycled" to the last track on the disc.

Making a Forward Track Search:

Press the **▶▶** button to display the desired track number.
Press once to fast forward to the next track, twice to fast forward to the track after that, and so forth.
Play starts at the beginning of the displayed track number.

NOTE (For disc changers)

You cannot make a forward track search when listening to the last track on a disc.

Disc Search

(Function of disc changers)

Search forwards or backwards through the discs in a disc changer until you reach the one that you want to listen to.

Making a Reverse Disc Search:

Press the DISC— button to display the desired disc number. Each time the button is pressed, the displayed disc number decreases by one. Play starts at the beginning of the displayed disc.

Making a Forward Disc Search:

Press the DISC+ button to display the desired disc number. Each time the button is pressed, the displayed disc number increases by one. Play starts at the beginning of the displayed disc.

NOTE

"Load" is displayed when discs are being exchanged on the disc changer.

Track / Disc Repeat

Repeat playing the current track or disc.

Turning Repeat Play Function On/Off:

Press the REP button to switch the repeat play function on and off as follows :

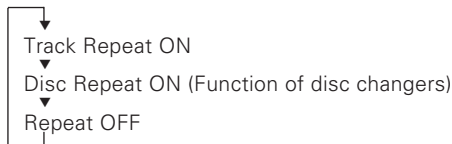

"Track Repeat ON"/"Repeat ON" is displayed and the track number blinks in the display when track repeat is on. "Disc Repeat ON" is displayed and the disc number blinks in the display when disc repeat is on.

NOTE

Repeat play is cancelled when you eject the disc.

Track Scan

Successively play the beginning of each track on a disc until you find the track that you want to listen to.

Starting the Track Scan:

Press the SCAN button. "Scan ON" is displayed and the first 10 seconds of each track are played, and the tracks are played in order.

The track number currently being heard blinks in the display.

Stopping to Listen to the Track Being Scanned:

Press the ►|| or SCAN button again to stop the scan and keep on listening to a track normally.

NOTE

The track scan function is cancelled when you eject the disc.

Random Play

Play all the tracks on the current disc in random order.

- 1 Press the RDM button to switch the random play function on and off.

"Random ON" is displayed when random play is turned on.

The display of the track number changes continuously as the next track is being selected.

When the track has been selected, play starts.

The selected track number blinks in the display as it is being played.

NOTE (For disc changers)

When all the tracks on a certain disc have been played using the random play function, the next disc on the changer starts playing (with the random play function still turned on).

- 2 To change the track being heard, press the ►►| button. Another track is selected and played.

NOTE

Random play is cancelled when you eject the disc.

External disc control features

Magazine Random Play *(Function of disc changers)*

Play the tracks on all the discs in the disc changer in random order.

- 1 Press the M.RDM button to switch the magazine random play function on and off.
"M.Random ON" is displayed when magazine random play is turned on.
The display of the disc and track numbers change continuously as the next track is being selected.
When the disc/track has been selected, play starts.
The selected disc/track number blinks in the display as it is being played.
- 2 To change the track being heard, press the ►► button.
Another disc/track is selected and played.

NOTE

- Magazine random play is cancelled when you eject the disc.
- The time needed for random selection depends on the number of discs loaded in the disc magazine.

Text Scroll

This function permits the text to be scrolled and the entire text to be displayed. The scrolling method differs depending on the setting of scrolling in the menu.

To scroll manually:

- 1 Display the disc or track title in the upper part display, referring to "Switching the Upper Part Display" (page 12).
- 2 Holding down the DISP button for one second or more results in one scrolling display of the titles.

To scroll automatically:

- 1 Display the disc or track title referring to the "Switching the Upper Part Display" (page 12) or "Switching the Lower Part Display" (page 14).
The titles will be displayed in one scrolling display.
- 2 Holding down the DISP button for one second or more results in one scrolling display of the titles.

NOTE

- Please see the menu settings (page 60) about switching between manual scrolling and automatic scrolling.
- You can scroll text when "Display Type A" or "Display Type B" has been selected by the switching display mode function.
For display mode selection, see "Switching display mode" (page 12).
- You cannot use the text scroll function during magazine random play.

Presetting Disc Names (DNPS)

Store the names of discs to be displayed when played.

- 1 Play the disc whose name you want to preset.

NOTE

- This function is not available for disc changers that do not feature the Disc Name Preset function.

- The Disc Name Preset function cannot be used during the Magazine random play as well as while a disc title or track title is displayed in the upper part display.
- 2 Press the NAME.S button for at least two seconds. "NAME SET" is displayed and the disc name preset mode is entered. The cursor blinks in the position where character input can be made.
 - 3 Press either the ◀◀ or ▶▶ button to move the cursor to the desired position. The ◀◀ button moves the cursor to the left, and the ▶▶ button to the right.
 - 4 Each press of the ▶|| button results in the type of characters that are to be entered changing between alphabet and numerals/symbols. Press the DISC+ or DISC- button to display the desired character. Characters that can be displayed are as follows.

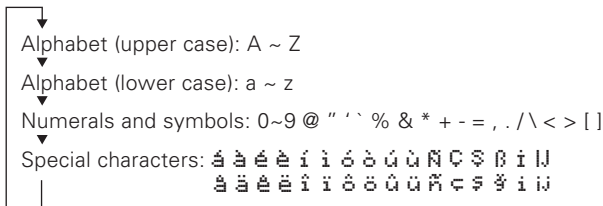

- 5 Continue steps 3 and 4 until all the characters are chosen for the name.

NOTE

You can enter up to 12 characters for each name.

- 6 Press the NAME.S button. The disc name is stored and the disc name preset mode is cancelled. If you make no entry in a 10-second period, the name will be stored with the characters input so far.

NOTE

- You cannot store the names of the discs in the MDs.
- The number of discs whose names can be stored will differ depending on the disc changer that is connected. Please see your disc changer manual for details.
- Discs are identified by their total length and number of tracks. If another disc happens to have the same specifications as one that you have already stored a name for, the name will be displayed for it, too.
- If you want to change the name of a disc, repeat steps 1 and 2 to display the name, and then repeat steps 3 and 4 to input the changes.
- Pressing the reset button erases the disc names stored in this unit, but does not erase the names stored in a disc changer.

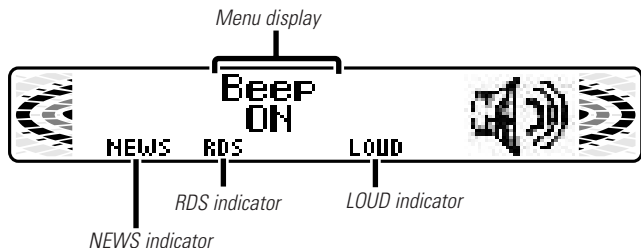
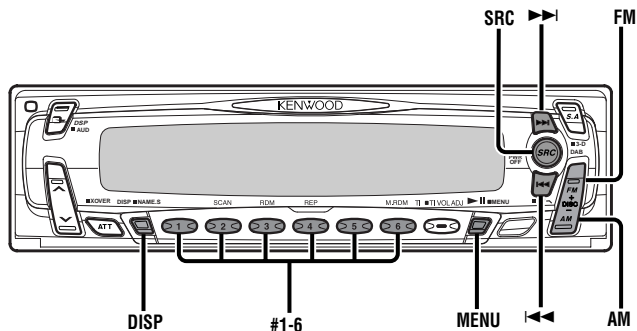

Menu System

You can set the defaults for additional functions in the menu mode. Make a setting for each function, referring to the following operations.

1 Enter the menu mode

Hold down the MENU button for one second or more. "MENU" is displayed when the menu mode is entered. The function that you can adjust is indicated with the current settings displayed.

2 Selecting function to set

Press the FM button to search through the functions until you see the one you want to adjust in the display. Press the AM button to search through the functions backward. Function items change in the order of features that follow in the menu system.

Example: If you want to switch the setting of the touch sensor tone function from on to off, first search through the functions until you see "Beep ON" in the display.

3 Changing setting for currently displayed function

Press either the ◀◀ or ▶▶ button. The setting will change for each function. Example: The setting of the touch sensor tone will switch from on to off, and "Beep OFF" is displayed.

4 Ending the menu mode

Press the MENU button.

NOTE

Make sure to end the menu mode when finished. If you fail to end the menu mode, several functions may not operate properly, including the Traffic Information function, the News Bulletin function with PTY news timeout setting, and the Alarm function.

Code Security Function <In Standby mode>

After a security code has been registered, power cannot be restored if the battery is disconnected from the unit unless the code is first input.

NOTE

All the steps in this procedure (1 through 7) must be completed before the code security function can be turned on. However, once the procedure is finished, it need not be repeated. Once the code security function has been activated, "Security" disappears from the MENU system. Note that it will no longer be possible to cancel this function afterwards.

- 1 Press the SRC button repeatedly to select the standby mode. "ALL OFF" is displayed when the standby mode is selected.
- 2 Hold down the MENU button for one second or more. "MENU" is displayed first and then "Security" is displayed.
- 3 Hold down either the ◀◀ or ▶▶ button for one second or more. "ENTER" will appear in the display for one second, indicating the code setting mode has been entered. When "CODE" appears in the display, you can start inputting the code.
- 4 Press the preset button and enter your security code. Use the security code shown on your Car Audio Passport. Example: Enter "3510" as your code, pressing the buttons as follows:

Step	Button to press	# Times pressed	Display
1	#1	4	"3"
2	#2	6	"5"
3	#3	2	"1"
4	#4	1	"0"

- 5 Hold down the DISP button for three seconds or more. The security code will be set. "RE-ENTER" will appear in the display for one second, asking you to enter the code once again for confirmation. When

"CODE" appears in the display, you can start inputting the code.

- 6 Press the Preset button and input the security code again.
- 7 Hold down the DISP button again for three seconds or more. "APPROVED" will appear in the display, with the code security function turning on. From this point on, if the unit is disconnected from the battery, the security code must be entered the first time that the unit's power is turned on. "ENTER" and "CODE" will appear in the display, asking you to input the code.

NOTE

If you input an incorrect security code, the code setting mode will be cancelled automatically. Follow the steps from 3 to 7 above again.

If you press the RESET button or remove the battery:

The first time you turn the unit on again, "CODE" will appear in the display, asking you to input the security code. Repeat steps 6 and 7 above, and input the security code. You can start operating the unit again when "APPROVED" appears in the display.

NOTE

If you enter the wrong code, "Waiting" is displayed and you cannot make further input of the code for a fixed interval (see table below), which grows longer each time you enter the wrong code.

When "CODE" is displayed, you can make input again.

Number of wrong inputs	Interval until next input is allowed
1	-
2	5 minutes
3	1 hour
4	24 hours

The number of wrong inputs is displayed.

Touch Sensor Tone

This function produces a beep sound that accompanies button operation. It can be switched on or off.

Display and setting:

"Beep ON" : Beep setting is on. (Default setting)

"Beep OFF" : Beep setting is off.

NOTE

The beep sound is not output from the preout jacks.

Manual Time Adjustment

Adjust the time manually.

NOTE

This adjustment is available only when the automatic time adjustment is set to off. (page 56)

Display and setting:

- 1 Select the display "Clock Adjust" during the selecting function in the menu system.
- 2 Hold down either the **◀◀** or **▶▶** button for one second or more to enter the Manual time adjustment mode.
The time display will blink.
- 3
 - Adjusting the hours
Press the **FM** button to advance the hours, or press the **AM** button to make the hours go back.
 - Adjusting the minutes
Press the **▶▶** button to advance the minutes, or press the **◀◀** button to make the minutes go back.
- 4 Press the **MENU** button to end the Manual Time Adjustment mode.
Exiting the Manual Time Adjustment mode would start the clock counting.

Menu settings

Calendar Adjustment

Adjust the date for the unit so that you can use the calendar function.

Display and setting:

- 1 Select the display "Date Adjust" during the selecting function in the menu system.
- 2 Hold down either the ◀◀ or ▶▶ button for one second or more to enter the Calendar adjustment mode.
The date display will blink.
- 3 **Selecting the item (day, month, or year) to adjust**
Press the ◀◀ or ▶▶ button.
The item blinking in the display can be adjusted.
- 4 **Adjusting the date**
Press the FM or AM button.
The item of the date blinking in the display will change.
- 5 Press the MENU button to end the Calendar Adjustment mode.

Calendar Mode

You can set the date formats of the calendar function.

Display and setting:

- 1 Select the display "Date Mode" during the selecting function in the menu system.
- 2 Press the ◀◀ and ▶▶ button to select the date format you want to show in the display.
The sample of the date format for today is displayed.

Automatic Time Adjustment

With automatic time adjustment, you can set the clock time automatically according to time data sent from RDS stations (after receiving RDS signals for several minutes). You can also set the time manually if the automatic time adjustment function is turned off.

Display and setting:

"SYNC ON" : Automatic time adjustment (Default setting)
"SYNC OFF" : Manual time adjustment

Adjusting Time Automatically:

Tune into an RDS station for 3 or 4 minutes.
The time adjusts automatically to the correct local time.

NOTE

The time is not adjusted when the RDS station you are tuned to is not transmitting a time signal. Choose another RDS station in such a case.

Disabled System Indicator (DSI)

A red indicator blinks on the unit after the faceplate is removed, warning potential thieves.

Display and setting:

"DSI ON" : The disabled system indicator is on. (Default setting)
"DSI OFF" : The disabled system indicator is off.

Icon/Spectrum analyzer Select

This function permits switching of the spectrum analyzer display.

Display and setting:

- 1 Select the display "Icon/Speana Select" during the selecting function in the menu system.
- 2 Pressing the **◀◀** or **▶▶** button switches the Icon/Spectrum analyzer.

NOTE

You cannot operate when the display mode is set to "Display Type B".

Font Select

You can change the font used on the display.

Display and setting:

- 1 Select the display "Font Select" during the selecting function in the menu system.
- 2 Pressing the **◀◀** or **▶▶** button switches the font on the display.

Dimmer

You can dim the display.

NOTE

The dimmer function is not available for units if the dimmer cable is not connected.

Display and setting:

- "Dimmer ON" : The dimmer setting is on. (Default setting)
- "Dimmer OFF" : The dimmer setting is off.

Loudness

<When the 5.1 ch surround processor unit is not connected>

This function amplifies low and high tones when the volume is turned down.

The LOUD indicator lights up, when the loudness function is on.

Display and setting:

- "Loudness ON" : The loudness function is on. (Default setting)
- "Loudness OFF" : The loudness function is off.

Menu settings

System Q

<When the 5.1 ch surround processor unit is not connected>

When this system is set to on, the System Q factors (Bass centre frequency, Bass quality factor, Bass extend, Middle centre frequency, Middle quality factor, and Treble centre frequency) appear during the audio control mode.

Display and setting:

"System Q ON" : The System Q factors appear and can be adjusted. (Default setting)

"System Q OFF" : The System Q factors do not appear.

External Amp Control

Adjust the bass boost level of the external amplifier using the main unit.

Display and setting:

"AMP Bass Flat" : Bass boost level is flat. (Default setting)

"AMP Bass +6" : Bass boost level is low (+6dB).

"AMP Bass +12" : Bass boost level is high (+12dB).

NOTE

As of December 2000, the power amplifiers controllable by the main unit are as follows:

KAC-X501F/PS501F/X401M/PS401M/X301T/PS301T/X201T/PS201T

News Bulletin Function with PTY News Timeout Setting

You can arrange to have news bulletins interrupt your current listening source, including other radio stations. When the News Bulletin function is on, the PTY News Timeout setting allows you to set the interval during which further news interruption cannot take place. You can adjust the PTY news interruption period from 10 to 90 minutes for each journey.

Display and setting:

"News OFF" (Default setting), "News 00min" – "News 90min"
(min= minutes)

: When you select the news interruption timeout interval, the News function turns on and the NEWS indicator lights up. When a news bulletin is received, "NEWS" will be displayed and reception will begin at the preset volume.

NOTE

- If you choose the "20min" setting, further news bulletins will not be received for 20 minutes once the first news bulletin is received.
- This function is only available if the desired station sends PTY-code for news bulletin or belongs to <Enhanced Other Network>-Network sending PTY-code for news bulletin.
- If you turn on the news bulletin function in the MW/LW band, the band is switched automatically to the FM band. However, the MW/LW band is not returned to when you turn off the function.

Local Seek Function <In Tuner mode>

With the local seek function turned on, auto seek tuning skips stations with relatively poor reception.

Display and setting:

"Local.S ON" : The local seek function is on.

"Local.S OFF" : The local seek function is off. (Default setting)

Selecting Tuning Mode <In Tuner mode>

You can choose from three tuning modes: auto seek, preset station seek, and manual.

Display and setting:

"Seek Mode Auto1" : Auto seek tuning mode (Default setting)

"Seek Mode Auto2" : Preset station seek tuning mode

"Seek Mode Manual" : Manual tuning mode

Auto Memory Entry <In Tuner mode>

You can automatically store all the receivable frequencies in the band currently being listened to, and then recall them with the touch of a button later. This function is especially useful when you are travelling and do not know what stations are available. Up to 6 frequencies can be stored this way.

Display and setting:

- 1 Select the display "Auto-Memory" during the selecting function in the menu system.
- 2 Hold down either the **I◀◀** or **▶▶I** button for two seconds or more to start auto memory function.
The numbers of the preset station buttons showed in order. When all the stations in a certain band are stored in the preset memory, the auto memory entry stops. The tuner then plays the last station received.

NOTE

- When the AF function is turned on whilst auto memory entry takes place, only RDS stations (i.e., stations with RDS capability) are stored. RDS stations that have been preset for FM1 cannot also be preset in FM2 or FM3.
- When the local seek function is turned whilst auto memory entry takes place, stations with poor reception are not stored.
- When the Traffic Information function is on, only the local traffic information station frequency will be stored.

Canceling Auto Memory Entry During Its Operation:

Press the **I◀◀** / **▶▶I** button whilst auto memory entry is taking place to stop the process.

Recalling a Preset Station:

Press the preset station button (#1-6) for the desired station. The number of the recalled station is displayed.

AF (Alternative Frequency) Function

When poor reception is experienced, automatically switch to another frequency broadcasting the same programme in the same RDS network with better reception.
The RDS indicator lights up when the AF function is turned on.

Display and setting:

"AF ON" : The AF function is on. (Default setting)
"AF OFF" : The AF function is off.

NOTE

When no other stations with stronger reception are available for the same programme in the RDS network, you may hear the incoming broadcast in bits and snatches. Turn off the AF function in such a case.

Restricting RDS Region (Region Restrict Function)

You can choose whether or not to restrict the RDS channels, received with the AF function for a particular network, to a specific region. When the Region Restrict Function is on, the region is restricted.

Display and setting:

"Regional ON" : The Region Restrict Function is on. (Default setting)
"Regional OFF" : The Region Restrict Function is off.

NOTE

Sometimes stations in the same network broadcast different programmes or use different programme service names.

Menu settings

Auto TP Seek Function

When the TI function is on and poor reception conditions are experienced when listening to a traffic information station, another traffic information station with better reception will be searched for automatically. This function is on, when unit is first powered on.

Display and setting:

"ATPS ON" : The Auto TP Seek Function is on.
If the traffic information station you are tuned to experiences poor reception, this function automatically seeks another TP station. (Default setting)

"ATPS OFF" : The Auto TP Seek Function is off.

Monaural Reception <In FM reception of Tuner mode>

When poor stereo reception is experienced, this function will reduce noise and improve listening conditions.

Display and setting:

"MONO ON" : The monaural reception is on.
"MONO OFF" : The monaural reception is off. (Default setting)

Text Scroll

This function permits the Radio text, CD text and MD title to be scrolled and the entire text to be displayed. Switching between manual scrolling and automatic scrolling is permitted.

Display and setting:

"Scroll Auto" : Automatic scrolling
"Scroll Manual" : Manual scrolling (Default setting)

Power OFF Timer

Set the time for the OFF Timer function activated when you selected Standby mode.
If the predefined time elapses, this unit's power is automatically turned off.

Display and setting:

"OFF ----" : Power OFF Timer function is cancelled.
"OFF 20min" : Unit's power goes OFF after 20 minutes.
(Default setting)
"OFF 40min" : Unit's power goes OFF after 40 minutes.
"OFF 60min" : Unit's power goes OFF after 60 minutes.

NOTE

The Power OFF Timer function is enabled only after the security code (page 54) is set up.

Built-in AUX Control

The "Built-in AUX Control" determines whether you include the TV(AUX) factor in the cycle-through items in the "Switching Modes" (page 11) function.

Display and setting:

"Builtin AUX ON" : The TV(AUX) factor appears. (Default setting)
"Builtin AUX OFF" : The TV(AUX) factor does not appear.

Basic Operations of remote control

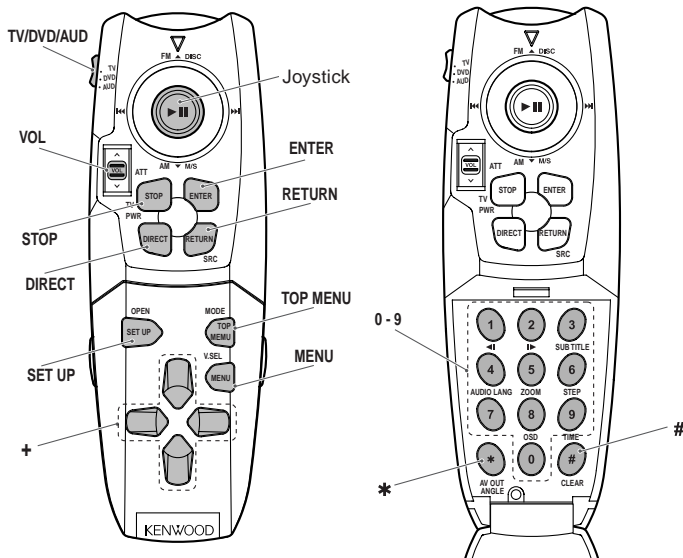

▶ TV/DVD/AUD button

When Controlling the Monitor/Television (Option : Made by Kenwood)

Switching to the TV position.

The functions you can control with this unit's remote control will vary according to the TV you are connected to. Refer to the TV instruction manual for the functions.

When Controlling the DVD/VCD

Switching to the DVD position.

When Controlling the audio source (External Disc,FM/AM tuner)

Switching to the AUD position.

▶ On Screen Display

DVD mode

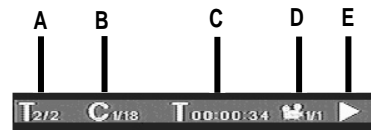

A: Title number
B: Chapter number
C: Title time / Chapter time

D: Angle indicator
E: Play indicator
F: Language for subtitle indicator

G: Language for voice indicator
H: Dolby Digital / DTS / LPCM / MPEG indicator

I: Repeat indicator
J: Track number
K: Track time / Disc time
L: PBC indicator



VCD mode



CD mode



Basic Operations of remote control

Loading and Replacing the Batteries for the Remote

▲ CAUTION

Do not set the remote on hot places such as above the dashboard.

1. Use two "AAA" batteries.
Slide the cover while pressing downwards to remove it as illustrated.
2. Insert the batteries with the ⊕ and ⊖ poles aligned properly following the illustration inside the case.

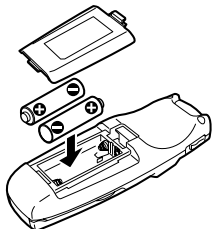

▲ WARNING

Store unused batteries out of the reach of children. Contact a doctor immediately if the battery is accidentally swallowed.

NOTE

- The provided batteries are intended for use in operation checking, and their service life may be short.
- When the remote controllable distance becomes short, replace both of the batteries with new ones.

Basic operations

► Switching the audio source mode <AUD position>

Each time you press the [SRC] button to switch the audio source mode.

► Volume <TV/DVD/AUD position>

Each time you press the VOL button to ^ side to increase the volume.

Each time you press the VOL button to v side to decrease the volume.

► Turning Attenuator On/Off <DVD/AUD position>

Press the [ATT] button to turn down the volume quickly. To return the volume to its original level, press the button again.

FM/AM Control Function < AUD position >

► Selecting the Preset Bands

- Each time you move the Joystick to front side to switch between the FM1, FM2 and FM3 bands.
- Move the Joystick to back side switch the AM band.

► Selecting the Station

- Move the Joystick to right side to seek up.
- Move the Joystick to left side to seek down.

► Selecting the PTY Search Screen

Each time you press the Joystick, the PTY Search Screen can be displayed and cancelled.

► Recalling Preset Station

Press either [1] - [6] for the desired station.

► Direct Search

- 1 Press the [DIRECT] button to switch the direct search mode.
- 2 Press the [0] - [9] buttons and enter the frequency.

DVD/VCD/CD Control Function < DVD position >

► Pausing and Restarting Disc Play

- Press the Joystick to make the disc pause.
- Press the Joystick to start play again.

► Manual Search

Forward search

Move the Joystick to front side.

Reverse search

Move the Joystick to back side.

Cancelling the search

Press the [►II] button to resume playback.

NOTE (DVD/VCD)

Each time you move the Joystick, the search speed goes from 2 times(◀◀/▶▶) to 3 times(◀◀◀/▶▶▶).

► Chapter/Track Search

Forward search

Move the Joystick to right side.

Reverse search

Move the Joystick to left side.

► Slow playback (DVD/VCD)

Slow playback is possible in 3 speed steps.

Forward slow playback

Press the [2(►)] button.

Reverse slow playback

Press the [1(◀)] button.

Cancelling the slow playback

Press the [►II] button to resume playback.

NOTE

- Press the button once to start and continue forward or reverse search at a high speed. Each time you press the button, the search speed goes from 1/2 times to 1/4 times to 1/8 times.
- Reverse slow playback is not available with a VCD.

► Frame-by-frame playback (DVD/VCD)

Each time press the [6(STEP)] butto advance to the next frame.

Cancelling the frame-by-frame playback

Press the ►II button to resume normal playback.

► Stopping playback

- Press the [STOP] button once during playback stops it and the position where it is stopped is stored in memory.(When the ►■ indicator is displayed)
- Press the [STOP] button twice to cancel playback.

► Switching the Menu Screen (DVD)

Press the [MENU] to display the menu.

Selecting the menu item

Press the each the [+] buttons to select the menu item.

Setting the menu item

Press the [ENTER] button.

Switching the top menu item

Press the [TOP MENU] button.

Returning to the menu

Press the [RETURN] button.

► Switching the Viewing Angle (DVD)

<When the DVD disc being played contains the scenes recorded from multiple viewing angles.>

Each time you press the [*] button to switch the viewing angle.

NOTE

- Depending on the disc, the angle may switch in one of two ways.
 - Seamless:
 - The angle switches smoothly.
 - Non-seamless:
 - When the angle is switched, a still picture is displayed first, after which the angle switches.

► Selecting the Sub Title Language (DVD)

Each time you press the [3(SUB TITLE)] button to change the sub title language.

► Selecting the Audio Language (DVD)

Each time you press the [4(AUDIO LANG)] button to change the voice language.

Basic Operations of remote control

► Chapter, Title, Time and Number Search(DVD)

- 1 Each time you press the [DIRECT] button the direct search mode switches between the chapter, title, time and number.
- 2 Press the [0] - [9] buttons and enter the number or time.
- 3 Press the [ENTER] button to start the search for chapter, title and number search.

NOTE

- The number you are entering can be deleted with the [CLEAR] button.
- When the [►II] button is pressed, the Direct Entry mode is canceled.

► PBC (Playback Control) Function On/Off for VCD version 2.0

Insert the VCD version 2.0 disc and press the [MENU] button.

NOTE

Setting can be done while disc play is stopped.

► PBC (VCD)

Use the [ENTER] / [RETURN] buttons and Joystick (left / right)

Direct Number Search

- 1 Press the [DIRECT] button to display the menu.
- 2 Press the [0] - [9] buttons and enter the number .
- 3 Press the [ENTER] button to start the search.

NOTE

- The number you are entering can be deleted with the [CLEAR] button.
- When the [►II] button is pressed, the Direct Entry mode is canceled.

► Direct Track Search (CD)

- 1 Press the [DIRECT] button to switch the direct track search mode.
- 2 Press the [0] - [9] buttons and enter the track number.
- 3 Move the Joystick to right or left side to start the track search.

NOTE

- The number you are entering can be deleted with the [CLEAR] button.
- When the [►II] button is pressed, the Direct Entry mode is canceled.

► Viewing Zoom

Zooming the image

Each time the [5(ZOOM)] button is pressed the image switches between zoom (ON) and normal (OFF).

► Displaying the On Screen Display(Monitor)

Each time you press the [8(OSD)] button to switches as follows:

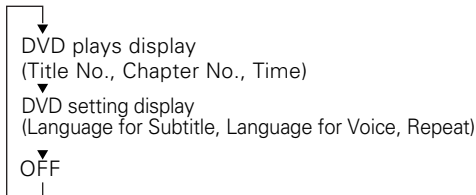

► Switching the Time Display for Disc(Monitor)

Press the [9] button.

Each time you press the [9] button, the time display during disc play switches as follows:

DVD

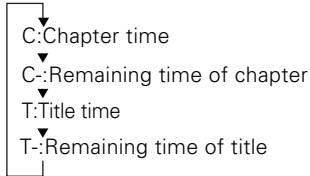

NOTE

- The chapter time is not displayed depending on software.
- When the ACC is turned ON/OFF the Monitor Time Display returns to the original setting.

VCD/CD

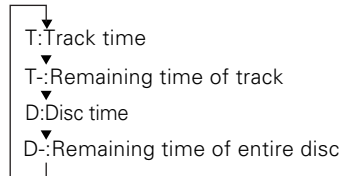

NOTE

When the ACC is turned ON/OFF the Monitor Time Display returns to the original setting.

External Disc Control Function< AUD position >

► Pausing and Restarting Disc Play

- Press the Joystick to make the disc pause.
- Press the Joystick to start play again.

► Track Search

- Move the Joystick to left side to search through the tracks backwards.
- Move the Joystick to right side to search through the tracks forwards.

► Disc Search

- Move the Joystick to back side to search through the discs backwards.
- Move the Joystick to front side to search through the discs forwards.

► Direct Track Search

- 1 Press the [0] - [9] buttons and enter the track number.
- 2 Move the Joystick to right or left side to start the track search.





► Direct Disc Search

- 1 Press the [0] - [9] buttons and enter the disc number.
- 2 Move the Joystick to front or back side to start the disc search.

Accessories

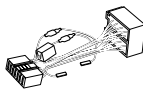



External view

..... Number of items

- | | | |
|---|---|--------|
| ① |  |1 |
| ② |  |2 |
| ③ |  |1 |
| ④ |  |1 |

External view

..... Number of items

- | | | |
|---|---|--------|
| ⑤ |  |1 |
| ⑥ |  |4 |
| ⑦ |  |2 |
| ⑧ |  |1 |

▲CAUTION

The use of any accessories except for those provided might result in damage to the unit. Make sure only to use the accessories shipped with the unit, as shown above.

Installation Procedure

- To prevent short circuits, remove the key from the ignition and disconnect the ⊖ terminal of the battery.
- Make the proper input and output cable connections for each unit.
- Connect the cable on the wiring harness.
- Take Connector B on the wiring harness and connect it to the speaker connector in your vehicle.
- Take Connector A on the wiring harness and connect it to the external power connector on your vehicle.

- Connect the wiring harness connector to the unit.
- Install the unit in your car.
- Reconnect the ⊖ terminal of the battery.
- Press the reset button.

▲CAUTION

- If your car is not prepared for this special connection-system, consult your KENWOOD dealer.
- Only use antenna conversion adapters (ISO-JASO) when the antenna cord has an ISO plug.
- Make sure that all cable connections are securely made by inserting jacks until they lock completely.
- If your vehicle's ignition does not have an ACC position, or if the ignition cable is connected to a power source with constant voltage such as a battery cable, the power will not be linked with the ignition (i.e., it will not turn on and off along with the ignition). If you want to link the unit's power with the ignition, connect the ignition cable to a power source that can be turned on and off with the ignition key.
- If the fuse blows, first make sure that the cables have not caused a short circuit, then replace the old fuse with one with the same rating.
- Do not let unconnected cables or terminals touch metal on the car or anything else conducting electricity. To prevent short circuits, also do not remove the caps on the ends of the unconnected cables or the terminals.
- Connect the speaker cables correctly to the terminals to which they correspond. The unit may receive damage or fail to work if you share the ⊖ cables and/or ground them to any metal part in the car.
- After the unit is installed, check whether the brake lamps, indicators, wipers, etc. on the car are working properly.
- Insulate unconnected cables with vinyl tape or other similar material.
- Some disc changers need conversion cables for connection. See the section on "Safety Precautions" for details.
- If the console has a lid, make sure to install the unit so that the faceplate does not hit the lid when closing and opening.
- Mount the unit so that the mounting angle is 30° or less.

Connecting Cables to Terminals

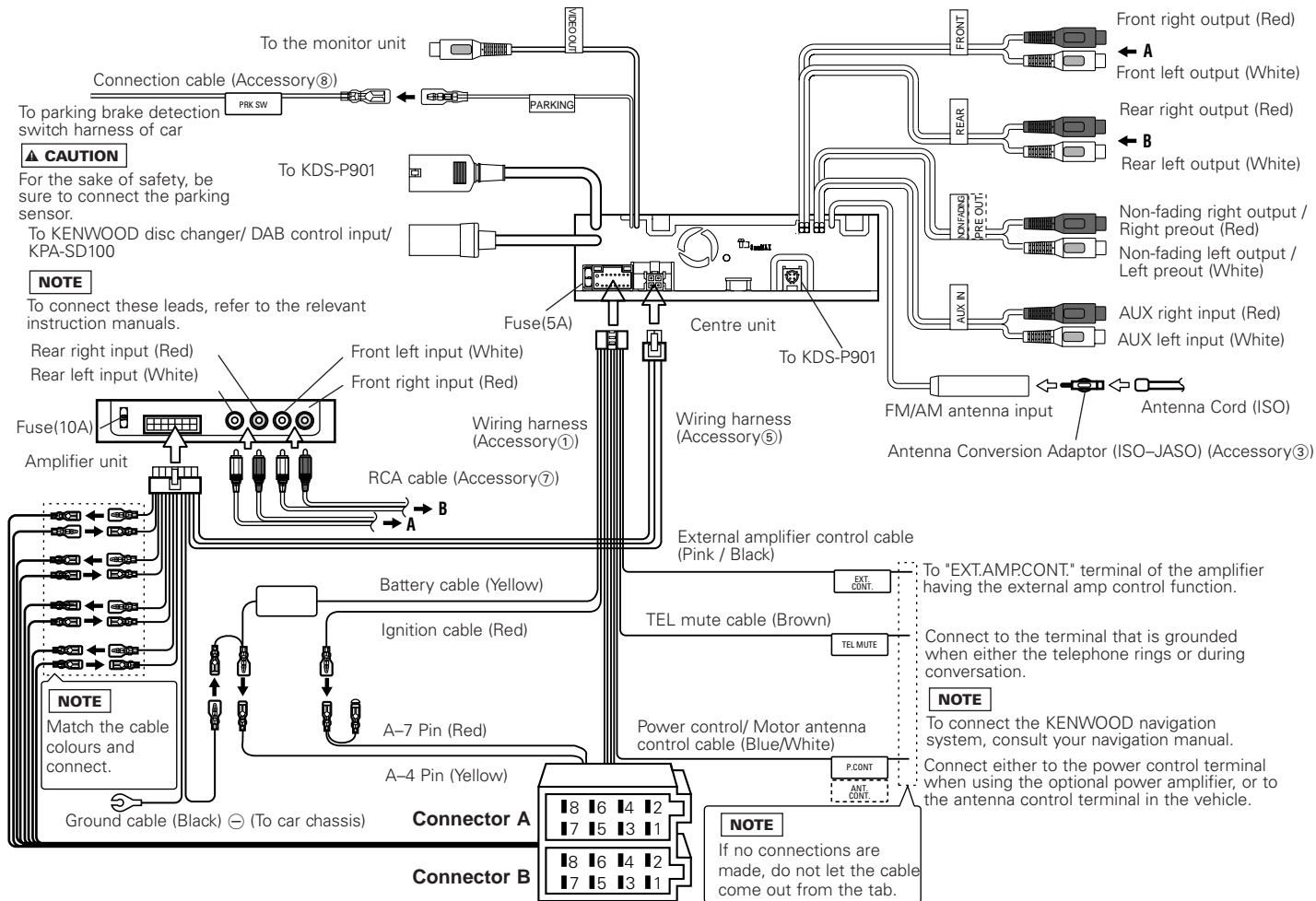

Connecting Cables to Terminals

Connector Function Guide		
Pin Numbers for ISO Connectors	Cable Colour	Functions
External Power Connector		
A-4	Yellow	Battery
A-5	Blue/White	Power Control
A-6	Orange/White	Dimmer
A-7	Red	Ignition (ACC)
A-8	Black	Earth (Ground) Connection
Speaker Connector		
B-1	Purple	Rear Right (+)
B-2	Purple/Black	Rear Right (-)
B-3	Gray	Front Right (+)
B-4	Gray/Black	Front Right (-)
B-5	White	Front Left (+)
B-6	White/Black	Front Left (-)
B-7	Green	Rear Left (+)
B-8	Green/Black	Rear Left (-)

⚠WARNING Connecting the ISO Connector (see p.67)

The pin arrangement for the ISO connectors depends on the type of vehicle you drive. Make sure to make the proper connections to prevent damage to the unit.

The default connection for the wiring harness is described in **1** below. If the ISO connector pins are set as described in **2** or **3**, make the connection as illustrated.

- 1** (Default setting) The A-7 pin (red) of the vehicle's ISO connector is linked with the ignition, and the A-4 pin (yellow) is connected to the constant power supply.

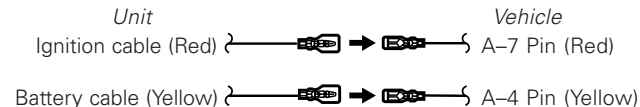

- 2** The A-7 pin (red) of the vehicle's ISO connector is connected to the constant power supply, and the A-4 pin (yellow) is linked to the ignition.

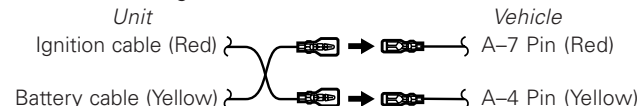

- 3** The A-7 pin (red) of the vehicle's ISO connector is not connected to anything, whilst the A-4 pin (yellow) is connected to the constant power supply (or both the A-7 (red) and A-4 (yellow) pins are connected to the constant power supply).

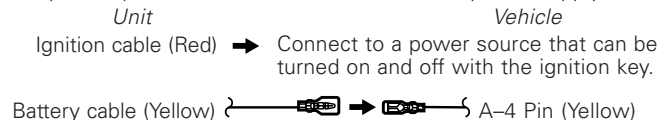

Installation

■ Installation

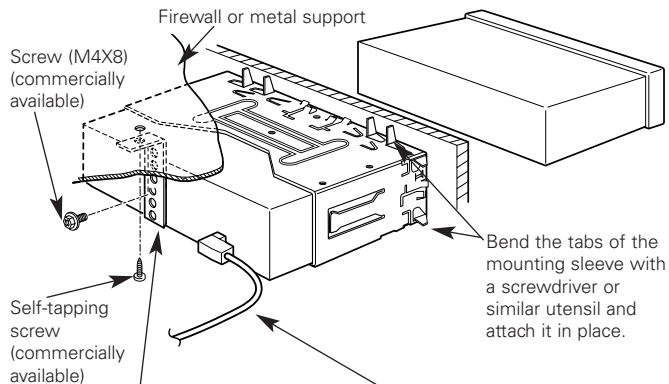

Bend the tabs of the mounting sleeve with a screwdriver or similar utensil and attach it in place.

Optical cable (Provided with the KDS-P901)

▲ CAUTION

When handling an optical cable for wiring, use care not to exceed the minimum cable bend radius of 30 mm. If you exceed the minimum bend limit, optical fibers within the optical cable may be damaged. When installing the DVD receiver unit on the vehicle, ensure that the optical cable is not stuck between the DVD receiver unit and vehicle parts.

NOTE

Make sure that the unit is installed securely in place. If the unit is unstable, it may malfunction (eg, the sound may skip).

■ Removing the hard rubber frame

- 1 Engage the catch pins on the removal tool and remove the two locks on the lower level. Lower the frame and pull it forward as shown in the figure.

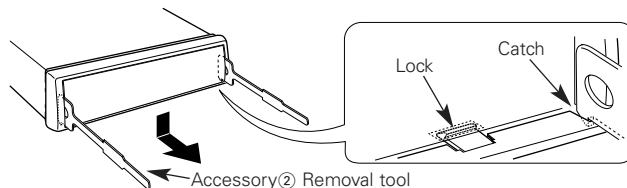

- 2 When the lower level is removed, remove the upper two locations.

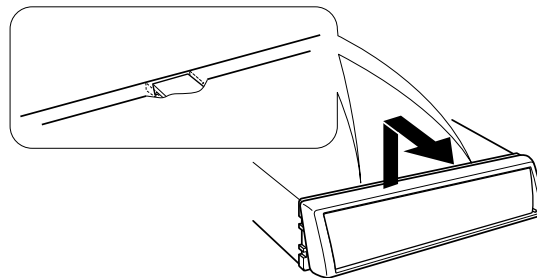

NOTE

The frame can be removed from the top side in the same manner.

Installation

■ Removing the Unit

- 1 Refer to the section "Removing the hard rubber frame" and then remove the hard rubber frame.
- 2 Remove the screw (M4×8) on the back panel.
- 3 Insert the two removal tools deeply into the slots on each side, as shown.

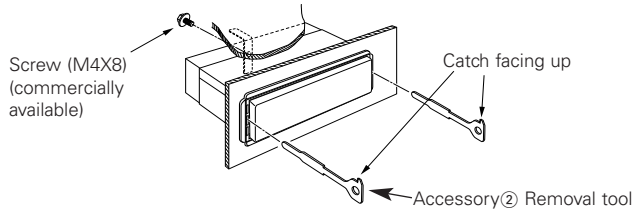

- 4 Lower the removal tool toward the bottom, and pull out the unit halfway whilst pressing towards the inside.

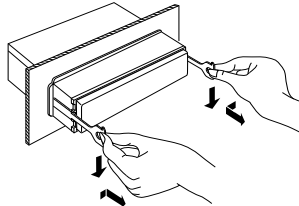

▲CAUTION

Be careful to avoid injury from the catch pins on the removal tool.

- 5 Pull the unit all the way out with your hands, being careful not to drop it.

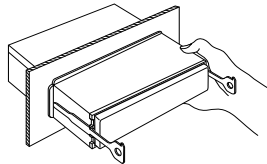

■ Screwing the Faceplate on the Unit

If you want to fasten the faceplate to the main unit so that it does not fall off, screw in the provided screw (M2 × 3 mm) in the hole shown below.

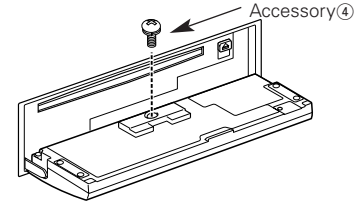

▲CAUTION

Never insert the provided screw (M2 × 3 mm) in any other screw hole than the one specified. If you screw it in another hole, it will contact and may cause damage to the mechanical parts inside the unit.

■ Installation for Amplifier unit

Use the tapping screw (ø4 × 16 mm) to secure the hideaway unit to the audio board.

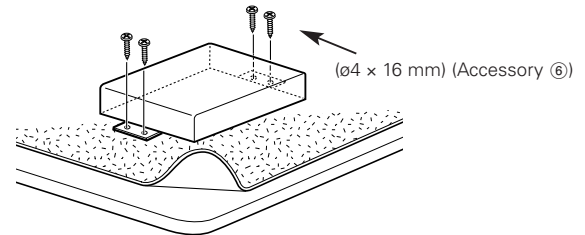

Troubleshooting Guide

What might appear to be a malfunction in your unit may just be the result of slight misoperation or miswiring. Before calling service, first check the following table for possible problems.

PROBLEM	POSSIBLE CAUSE	SOLUTION
The power does not turn on.	The fuse has blown.	After checking for short circuits in the cables, replace the fuse with one having the same rating.
	No ACC position on vehicle ignition.	Connect the same cable to the ignition as the battery cable.
If you have selected Standby mode, the power will go OFF automatically.	The Power Off Timer function has been activated.	If you do not want the power to go OFF automatically, cancel the Power Off Timer function.
Nothing happens when the buttons are pressed.	The computer chip in the unit is not functioning normally.	Press the reset button on the unit (see page 4).
Radio reception is poor.	The car antenna is not extended.	Pull out the antenna all the way.
	The antenna control cable is not connected.	Connect the cable correctly, referring to the section on "Connecting Cables to Terminals".
The memory is erased when the ignition is turned off.	The battery cable has not been connected to the proper terminal.	Connect the cable correctly, referring to the section on "Connecting Cables to Terminals".
	The ignition and battery cable are incorrectly connected.	Connect the cable correctly, referring to the section on "Connecting Cables to Terminals".
The TEL mute function does not work.	The TEL mute cable is not connected properly.	Connect the cable correctly, referring to the section on "Connecting Cables to Terminals".
The TEL mute function turns on even though the TEL mute cable is not connected.	The TEL mute cable is touching a metal part of the car.	Pull the TEL mute cable away from the metal part of the car.
TV (AUX) cannot be selected.	"Built-in AUX Control" is turned off.	Refer to the "Built-in AUX Control" in the menu setting (page 60) and turn on the "Built-in AUX Control" .

PROBLEM	POSSIBLE CAUSE	SOLUTION
No sound can be heard, or the volume is low.	The Attenuator function is turned on.	Turn off the Attenuator function.
	The fader and/or balance settings are set all the way to one side.	Reset the fader and/or balance settings.
	The input/output cables or wiring harness are connected incorrectly.	Reconnect the input/output cables and/or the wiring harness correctly. See the section on "Connecting Cables to Terminals".
The sound quality is poor or distorted.	A speaker cable may be pinched by a screw in the car.	Check the speaker wiring.
	The speakers are not wired correctly.	Reconnect the speaker cables so that each output terminal is connected to a different speaker.

DVD/VCD/CD control mode

PROBLEM	POSSIBLE CAUSE	SOLUTION
A disc ejects as soon as it is loaded.	The disc is upside-down.	Load the disc with the labelled side up.
	The disc is quite dirty.	Clean the disc, referring to the section on "Cleaning Discs" (see page 6).
The sound skips on a disc.	The disc is scratched or dirty.	Clean the disc, referring to the section on "Cleaning Discs" (see page 6).
The specified track does not play.	Random play has been selected.	Turn off the random play function.
Can't remove disc.	The cause is that more than 10 minutes has elapsed since the vehicle ACC switch was turned OFF.	The disc can only be removed within 10 minutes of the ACC switch being turned OFF. If more than 10 minutes has elapsed, turn the ACC switch ON again and press the Eject button.

Troubleshooting Guide

PROBLEM	POSSIBLE CAUSE	SOLUTION
The sound/picture skips on a DVD/VCD/CD.	The disc is scratched or dirty.	Clean the disc, referring to the section on "Cleaning discs" (see p. 6).
A VCD cannot be played using menus.	The VCD disc being played is not compatible with P.B.C.	Menu playback is available only with VCD discs recorded with P.B.C.
The subtitle is not displayed.	The DVD disc being played does not contain the recording of subtitles.	The subtitle cannot be displayed when the DVD disc being played does not contain the recording of subtitles.
The voice (or subtitle) language cannot be changed.	The DVD disc being played does not contain the recording of more than one audio (or subtitle) language.	The voice (or subtitle) language cannot be changed when the DVD disc being played does not contain the recording of more than one voice (or subtitle) language.
The viewing angle cannot be changed.	The DVD disc being played does not contain the recording of more than one angle.	The viewing angle cannot be changed when the DVD disc being played does not contain the recording of more than one angle.
	You are attempting to switch the angle in a DVD section where more than one angle is not recorded.	More than one viewing angle may be recorded only in limited sections in a disc.
Playback will not start even after a title is selected.	A viewing restriction (RATING) has been set for the disc.	Check the viewing restriction level (RATING) setting.
The voice or subtitle language selected in the initial setting is not played.	The DVD disc being played does not contain the recording of the selected voice or subtitle language.	Use a DVD disc containing the recording of the selected voice or subtitle language.

External disc control mode

PROBLEM	POSSIBLE CAUSE	SOLUTION
The disc control mode cannot be selected.	No cable has been connected to the disc changer input terminal on the unit.	Connect the cable to the disc changer input terminal on the unit.
The specified disc does not play, but another one plays instead.	The specified CD is very dirty.	Clean the CD.
	The CD is upside-down.	Load the CD with the labelled side up.
	The disc is loaded in a different slot from that specified.	Eject the disc magazine and check the number for the specified disc.
	The disc is severely scratched.	Try another disc instead.
The sound skips.	Something is touching the disc changer.	Remove whatever is touching it.
	The CD is scratched or dirty.	If skipping happens at the same place when the car is stopped, something is wrong with the CD. Clean the CD.
The display shows that the changer is being played, but no sound can be heard.	The computer chip in the unit is not functioning normally.	Press the reset button on the unit (see page 4).
The specified track does not play.	Random play or magazine random play has been selected.	Turn off the random play or magazine random play function.
Track repeat, disc repeat, track scan, random play, and magazine random play start by themselves.	The setting is not cancelled.	The settings for these functions remain on until the setting to off or the disc ejected, even if the power is turned off or the source changed.

If the following situations, consult your nearest service centre:

- Even though the disc changer is connected, the Disc Changer Mode is not on, with "AUX" showing in the display during the Changer Mode.
- Even though no device (CA-C1AX, KDC-CPS87, KDC-CX87, KDC-CPS85, KDC-CX85, KDC-CPS82 or KDC-CX82) is connected, the AUX Mode is entered when switching modes.

Troubleshooting Guide

The following messages are displayed when certain problems are occurring in your system. Take the recommended actions.

Eject	No disc magazine has been loaded in the changer. The disc magazine is not completely loaded. ⇒ Load the disc magazine properly. No disc in the unit. ⇒ Insert the disc.
No Disc	No disc has been loaded in the disc magazine. ⇒ Load a disc into the disc magazine.
TOC Error	No disc has been loaded in the disc magazine. ⇒ Load a disc into the disc magazine. The disc is very dirty. The disc is upside-down. The disc is scratched a lot. ⇒ Clean the disc and load it correctly.
Blank Disc	Nothing has been recorded on the MD.
No Tr Disc	No tracks are recorded on the MD, although it has a title.
NO PANEL	The faceplate of the slave unit being connected to this unit has been removed. ⇒ Replace it.
E-77	The unit is malfunctioning for some reason. ⇒ Press the reset button on the unit. If the "E- 77", code does not disappear, consult your nearest service centre.
Mecha Error	Something is wrong with the disc magazine. Or the unit is malfunctioning for some reason. ("WRONG DISC FORMAT" is displayed on the monitor.) ⇒ Check the disc magazine. And then, press the reset button on the unit. If the "Mecha Error" code does not disappear, consult your nearest service centre.
Hold Error	The protective circuit in the unit activates when the temperature inside the automatic disc changer exceeds 60°C (140°F), stopping all operation. ⇒ Cool down the unit by opening the windows or turning on the air conditioner. As the temperature falls below 60°C (140°F), the disc starts playing again.
IN	If this indicator blinks, the DVD player is malfunctioning. ⇒ Eject the disc and try inserting it again. If the disc cannot be ejected, press the eject button and hold it in until the disc is ejected.
Region Error	The DVD software encoded for other region code. ("WRONG REGEON CODE" is displayed on the monitor.)
Read Error	Unsupported disc or the disc can't be read. ("WRONG DISC FORMAT" is displayed on the monitor.)

Specifications

Specifications subject to change without notice.

FM tuner section

Frequency range (50 kHz space)	87.5 MHz – 108.0 MHz
Usable sensitivity (S/N = 26dB)	0.7 μ V/75 Ω
Quieting Sensitivity (S/N = 46dB)	1.6 μ V/75 Ω
Frequency response (\pm 3.0 dB)	30 Hz – 15 kHz
Signal to Noise ratio (MONO)	65 dB
Selectivity (DIN) (\pm 400 kHz)	\geq 80 dB
Stereo separation (1 kHz)	35 dB

MW tuner section

Frequency range (9 kHz space)	531 kHz – 1611 kHz
Usable sensitivity (S/N = 20dB)	25 μ V

LW tuner section

Frequency range	153 kHz – 281 kHz
Usable sensitivity (S/N = 20dB)	45 μ V

DVD player section

D/A conversion	1 Bit
Wow and flutter	Below measurable limit
Frequency response	
Sampling frequency; 44.1 kHz (CD)	20 Hz - 20 kHz
Sampling frequency; 48 kHz	20 Hz - 22 kHz
Sampling frequency; 96 kHz	20 Hz - 44 kHz
Total harmonic distortion	0.020 % (1 kHz)
Signal to noise ratio	115 dB (DVD 96 kHz)
Dynamic range	95 dB (DVD 96 kHz)
Disc format	DVD-VIDEO / VIDEO CD / CD-DA
Oversampling frequency	
.....	8 fs (Sampling frequency; 44.1, 48 kHz)
.....	4 fs (Sampling frequency; 96 kHz)
Quantifying bit number	16 / 20 / 24 bit
Optical out format	Dolby Digital/DTS/Linear PCM
Video output level (RCA jacks)	1 Vp-p/75 Ω

Audio section

Maximum output power	47 W x 4
Full Bandwidth Power (DIN 45324, +B=14.4V)	22 W x 4
Tone action	
Bass :	100 Hz \pm 10 dB
Middle :	1 kHz \pm 10 dB
Treble :	10 kHz \pm 10 dB
Preout level / Load (during disc play)	1800 mV/10 k Ω
Preout impedance (during disc play)	\leq 600 Ω

General

Operating voltage (11 – 16V allowable)	14.4 V
Centre Unit	
Current consumption	5 A
Installation Size (W x H x D)	182 x 53 x 156 mm
Weight	1.8 kg
Amplifier Unit	
Current consumption	10 A
Installation Size (W x H x D)	150 x 27 x 90 mm
Weight	0.7 kg

Free Manuals Download Website

<http://myh66.com>

<http://usermanuals.us>

<http://www.somanuals.com>

<http://www.4manuals.cc>

<http://www.manual-lib.com>

<http://www.404manual.com>

<http://www.luxmanual.com>

<http://aubethermostatmanual.com>

Golf course search by state

<http://golfingnear.com>

Email search by domain

<http://emailbydomain.com>

Auto manuals search

<http://auto.somanuals.com>

TV manuals search

<http://tv.somanuals.com>