

KENWOOD

KDC-X979 KDC-MP925 KDC-X879

CD-RECEIVER

INSTRUCTION MANUAL

KENWOOD CORPORATION

**Take the time to read through this instruction manual.
Familiarity with installation and operation procedures will help you
obtain the best performance from your new CD-receiver.**

For your records

Record the serial number, found on the back of the unit, in the spaces designated on the warranty card, and in the space provided below. Refer to the model and serial numbers whenever you call upon your KENWOOD dealer for information or service on the product.

Model KDC-X979/MP925/X879 Serial number _____



© B64-2741-00/00 (KV)

Contents

Warning	4	Tuner features	31
Safety precautions	5	Tuning Mode	
Notes	7	Tuning	
About CDs	8	Direct Access Tuning	
Notes on Multi-function Key System	9	Station Preset Memory	
Notes on playing MP3/WMA	10	Auto Memory Entry	
Notes on Sound Management System	12	Preset Tuning	
General features	13	SNPP (Station Name Preset Play)	
Power		RDS features	34
Hiding the Control Panel		Radio Text Scroll	
Selecting the Source		Registration of a station as a PTY	
Volume		Program Type preset	
Attenuator		PTY (Program Type)	
Rotary Volume knob operation mode select		CD/MP3/WMA/External disc control features	36
TEL Mute		Playing CD & MP3/WMA	
Display Mode Switching		Playing External Disc	
Side Graphic Display Switching		Fast Forwarding and Reversing	
Text Display Switching		Track/File Search	
Graphic part/ Spectrum Analyzer Display Switching		Disc Search/Folder Search	
Wallpaper selecting		Direct Track/File Search	
Text Display Switching		Direct Disc Search	
Station/Disc Naming (SNPS/DNPS)		Track/File/Disc/Folder Repeat	
Auxiliary Input Display Setting		Scan Play	
Panel Position Setting		Random Play	
Theft Deterrent Panel		Magazine Random Play	
Audio Control (KDC-MP925/KDC-X879)		Folder Select	
Subwoofer Output		Text/Title Scroll	
System Q (KDC-MP925/KDC-X879)		DNPP (Disc Name Preset Play)	
System Q (KDC-X979)		SIRIUS tuner control features	40
Speaker Setting (KDC-MP925/KDC-X879)		Select SIRIUS Satellite Radio Mode	
Dual Zone System		Switching Seek Mode	
Sound management features (KDC-X979)	26	Select the channel	
Audio control		Channel Search	
Audio Setup (Easy mode)		Direct Access Tuning	
Audio Setup (PRO mode)		Selecting the Preset Band	
Audio Setup Memory (PRO mode)		Channel Preset Memory	
Audio Setup memory Recall		Preset Tuning	
		Channel Scan	
		Text Scroll for SIRIUS tuner source	
		HD Radio control features	43
		Tuning	
		Auto Memory Entry	

Menu system 45

Menu System
Security Code
Touch Sensor Tone
Manual Clock Adjustment
Date Adjustment
Date Mode
Synchronize Clock
DSI (Disabled System Indicator)
Selectable Illumination
Triangle indicator setting
Font Type Select
Dimmer
OFF Wait Time Setting
Eject angle setting
Panel action setting
System Q Setting (KDC-X879)
Audio Setup (KDC-X979)
Built-in Amp Mute Setting
B.M.S. (Bass Management System)
(KDC-X979/KDC-X879)
B.M.S. Frequency Offset (KDC-X979/KDC-X879)
Traffic Information
CRSC (Clean Reception System Circuit)
Tuning Mode
Receive mode Setting
Auto Memory Entry
Text Scroll
Built-in Auxiliary input Setting
SIRIUS ID (ESN) display
CD Read Setting
Picture downloading (KDC-X979)
AMP Control (KDC-X979/KDC-X879)
Rotary volume operation select

Basic Operations of remote 53

Loading and Replacing the battery
Basic operations
In Tuner source
In Disc source
In SIRIUS tuner source
In HD Radio source

**Accessories/
Installation Procedure 55**

Connecting Wires to Terminals 56

Installation 57

Removing the Unit 59

Troubleshooting Guide 60

Specifications 64

▲Warning

▲CAUTION

Use of controls or adjustments or performance of procedures other than those specified herein may result in hazardous radiation exposure. In compliance with Federal Regulations, following are reproductions of labels on, or inside the product relating to laser product safety.

KENWOOD CORPORATION
2967-3, ISHIKAWA-CHO,
HACHIOJI-SHI
TOKYO, JAPAN

KENWOOD CORP. CERTIFIES THIS EQUIPMENT
CONFORMS TO DHHS REGULATIONS NO.21 CFR
1040. 10, CHAPTER 1, SUBCHAPTER J.

Location : Bottom Panel

FCC WARNING

This equipment may generate or use radio frequency energy. Changes or modifications to this equipment may cause harmful interference unless the modifications are expressly approved in the instruction manual. The user could lose the authority to operate this equipment if an unauthorized change or modification is made.

NOTE

This equipment has been tested and found to comply with the limits for a Class B digital device, pursuant to Part 15 of the FCC Rules. These limits are designed to provide reasonable protection against harmful interference in a residential installation. This equipment may cause harmful interference to radio communications, if it is not installed and used in accordance with the instructions. However, there is no guarantee that interference will not occur in a particular installation. If this equipment does cause harmful interference to radio or television reception, which can be determined by turning the equipment off and on, the user is encouraged to try to correct the interference by one or more of the following measures:

- Reorient or relocate the receiving antenna.
- Increase the separation between the equipment and receiver.
- Connect the equipment into an outlet on a circuit different from that to which the receiver is connected.
- Consult the dealer or an experienced radio/TV technician for help.

Safety precautions

▲WARNING

To prevent injury or fire, take the following precautions:

- Insert the unit all the way in until it is fully locked in place. Otherwise it may fall out of place when jolted.
- When extending the ignition, battery, or ground wires, make sure to use automotive-grade wires or other wires with a 0.75mm² (AWG18) or more to prevent wire deterioration and damage to the wire coating.
- To prevent a short circuit, never put or leave any metallic objects (such as coins or metal tools) inside the unit.
- If the unit starts to emit smoke or strange smells, turn off the power immediately and consult your Kenwood dealer.
- Make sure not to get your fingers caught between the faceplate and the unit.
- Be careful not to drop the unit or subject it to strong shock.
The unit may break or crack because it contains glass parts.

▲CAUTION

To prevent damage to the machine, take the following precautions:

- Make sure to ground the unit to a negative 12V DC power supply.
- Do not open the top or bottom covers of the unit.
- Do not install the unit in a spot exposed to direct sunlight or excessive heat or humidity. Also avoid places with too much dust or the possibility of water splashing.
- Do not set the removed faceplate or the faceplate case in areas exposed to direct sunlight, excessive heat or humidity. Also avoid places with too much dust or the possibility of water splashing.
- To prevent deterioration, do not touch the terminals of the unit or faceplate with your fingers.
- Do not subject the faceplate to excessive shock, as it is a piece of precision equipment.
- When replacing a fuse, only use a new one with the prescribed rating. Using a fuse with the wrong rating may cause your unit to malfunction.
- To prevent a short circuit when replacing a fuse, first disconnect the wiring harness.
- Do not place any object between the faceplate and the unit.
- Do not apply excessive force to the moving faceplate. Doing so will cause damage or malfunction.
- Do not apply excessive force to the open faceplate or place objects on it. Doing so will cause damage or breakdown.
- Do not use your own screws. Use only the screws provided. If you use the wrong screws, you could damage the unit.

Safety precautions

About CD players/disc changers connected to this unit

KENWOOD disc changers/ CD players released in 1998 or later can be connected to this unit. Refer to the catalog or consult your Kenwood dealer for connectable models of disc changers/ CD players.

Note that any KENWOOD disc changers/ CD players released in 1997 or earlier and disc changers made by other makers cannot be connected to this unit. Unsupported connection may result in damage. Setting the "O-N" Switch to the "N" position for the applicable KENWOOD disc changers/ CD players. The functions that can be used and the information that can be displayed will differ depending on the models being connected.



- You can damage both your unit and the CD changer if you connect them incorrectly.

LX-bus connection

The LX AMP and the sensor unit cannot be connected simultaneously.

You must connect any of them at a time.

(The power supply does not turn ON if you have connected both of them.)

Do Not Load 3-in. CDs in the CD slot

If you try to load a 3 in. CD with its adapter into the unit, the adapter might separate from the CD and damage the unit.

NOTE

- If you experience problems during installation, consult your Kenwood dealer.
- If the unit fails to operate properly, press the Reset button. The unit returns to factory settings when the Reset button is pressed. If the unit still fails to operate properly after the Reset button has been pressed, contact your local KENWOOD dealer for assistance.
- Press the reset button if the disc auto changer fails to operate correctly. Normal operation should be restored.

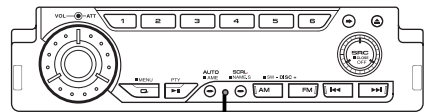

Reset button

- We recommend the use of 'Security Code' (page 46) to prevent theft.
- The illustrations of the display and the panel appearing in this manual are examples used to explain more clearly how the controls are used. Therefore, what appears on the display in the illustrations may differ from what appears on the display on the actual equipment, and some of the illustrations on the display may represent something impossible in actual operation.

Lens Fogging

Right after you turn on the car heater in cold weather, dew or condensation may form on the lens in the CD player of the unit. Called lens fogging, CDs may be impossible to play. In such a situation, remove the disc and wait for the condensation to evaporate. If the unit still does not operate normally after a while, consult your Kenwood dealer.

Notes

Cleaning the Unit

If the faceplate of this unit is stained, wipe it with a dry soft cloth such as a silicon cloth.

If the faceplate is stained badly, wipe the stain off with a cloth moistened with neutral cleaner, then wipe neutral detergent off.



- Applying spray cleaner directly to the unit may affect its mechanical parts. Wiping the faceplate with a hard cloth or using a volatile liquid such as thinner or alcohol may scratch the surface or erases characters.

Cleaning the Faceplate Terminals

If the terminals on the unit or faceplate get dirty, wipe them with a dry, soft cloth.

Cleaning the CD Slot

As dust tends to accumulate in the CD slot, clean it every once in a while. Your CDs can get scratched if you put them in a dusty CD slot.

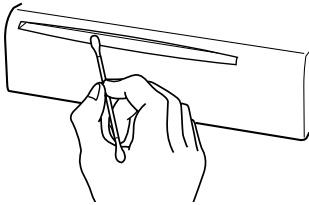

WOW, SRS and  symbol are trademarks of SRS Labs, Inc.

WOW technology is incorporated under license from SRS Labs, Inc.

NOTE

This Class B digital apparatus complies with Canadian ICES-003.

Sirius Satellite radio tuner

Refer to the Sirius tuner control features of this manual for the operation method of Sirius Satellite radio tuner KTC-SR901/SR902 (optional accessory) when connected.

Dolby Pro Logic II

The matrix decoding technologies that have been evolved from the conventional Dolby Pro Logic system and that is based on the latest digital matrix technologies. It realizes the excellent 5.1-channel sound playback of Dolby Surround and ordinary CD stereo sounds. You can enjoy surround channels as full-band sounds (from 20 Hz to 20 kHz) and stereo sources as real 5.1-channel sounds. The Movie mode, Music mode, Matrix mode, can be selected according to the playback source. When the Dolby Pro Logic II mode is selected, the sound level is slightly dropped due to its characteristics.

Manufactured under license from Dolby Laboratories.

"Dolby", "Pro Logic", and the double-D symbol are trademarks of Dolby Laboratories.

About CDs

Handling CDs

- Don't touch the recording surface of the CD.



- CD-R and CD-RW are easier to damage than a normal music CD. Use a CD-R or a CD-RW after reading the caution items on the package etc.
- Don't stick tape etc. on the CD. Also, don't use a CD with tape stuck on it.

When using a new CD

If the CD center hole or outside rim has burrs, use it after removing them with a ball pen etc.

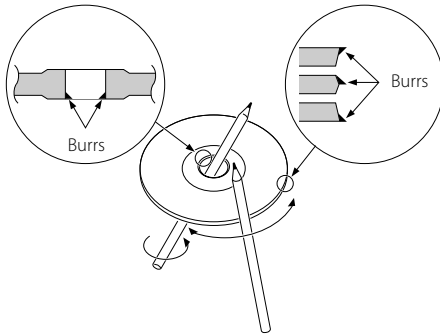

CD accessories

Don't use disc type accessories.

CD cleaning

Clean from the center of the disc and move outward.

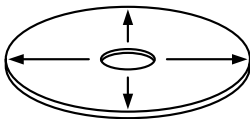

Removing CDs

When removing CDs from this unit pull them out horizontally.

CDs that can't be used

- CDs that aren't round can't be used.

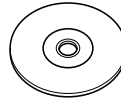

- CDs with coloring on the recording surface or that are dirty can't be used.
- This unit can only play the CDs with



It may not correctly play discs which do not have the mark.

- A CD-R or CD-RW that hasn't been finalized can't be played. (For the finalization process refer to your CD-R/CD-RW writing software, and your CD-R/CD-RW recorder instruction manual.)

CD storage

- Don't place them in direct sunlight (On the seat or dashboard etc.) and where the temperature is high.
- Store CDs in their cases.

Notes on Multi-function Key System

Multi-function Key System serves to control various functions with the [2] — [5] buttons. The basic operation of the Multi-function Key System is described below.

What's the Multi-function Key System?

This unit is equipped with the Multi-function Key System that enables the operation of multiple functions with one button.

For example, you can enter the Display Control Mode or turn ON/OFF the Random Play by pressing the [3] button during CD play.

Setting each function

The function display will show the controllable function of the [2] — [5] button above the button. Pressing the [2] — [5] button below the desired function enables the setting of the function.

Displaying the desired function

If five or more functions are available to be set with the [2] — [5] button, they are divided into multiple function groups (referred to as sections in this manual) for registration.

Press the [NEXT] button to switch the sections. If the display of the desired function is not shown, press the [NEXT] button 1 to 3 times to switch the sections until the wanted function display is shown. Example: Function display of CD & External disc source

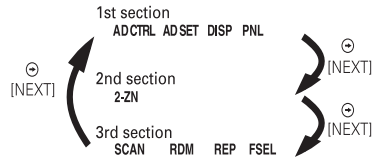

- "MRDM", "H-F", "SYNC" or "DISP" are displayed when an optional accessory is connected.

Real operational example of the Multi-function Key System

Example: Turning ON/OFF the Random Play during CD play.

1. Show the function display of the Random Play.
If "RDM" is not shown in the display, press the [NEXT] button to switch the sections until the "RDM" function display is shown above the [3] button.
2. Turn ON/OFF the Random Play.
Press the [3] button.
Each time the [3] button under the "RDM" function display is pressed the Random Play is turned ON/OFF.

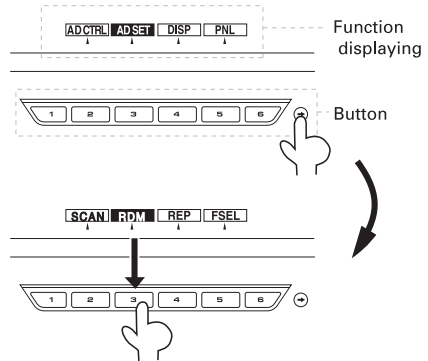

Notes on playing MP3/WMA

Note, however, that the MP3/WMA recording media and formats acceptable are limited. When writing MP3/WMA, pay attention to the following restrictions.

Acceptable media

The MP3/WMA recording media acceptable to this unit are CD-ROM, CD-R, and CD-RW. When using CD-RW, do full format not quick format to prevent malfunction.

Acceptable medium formats

The following formats are available for the media used in this unit. The maximum number of characters used for file and folder name including the delimiter (".") and three-character extension are indicated in parentheses.

- ISO 9660 Level 1 (32 characters)
- ISO 9660 Level 2 (31 characters)
- Joliet (64 character)
(KDC-MP925/X879; Up to 32 characters are displayed)
- Romeo (128 character)
(KDC-MP925/X879; Up to 64 characters are displayed)
- Long file name (200 characters)
(KDC-MP925/X879; Up to 64 characters are displayed)
- Maximum number of characters for folder name: 64
(KDC-MP925/X879; Joliet: Up to 32 characters are displayed)

For a list of available characters, see the instruction manual of the writing software and the section Entering file and folder names below. The media reproducible on this unit has the following limitations:

- Maximum number of directory levels: 8
- Maximum number of files per folder: 255
- Maximum number of folders:
KDC-X979; 100
KDC-MP925/X879; 50
- Maximum number of files and folders
(KDC-MP925/X879): 512

MP3/WMA written in the formats other than the above may not be successfully played and their file names or folder names are not properly displayed.

Settings for your MP3/WMA encoder and CD writer

Do the following setting when compressing audio data in MP3/WMA data with the MP3/WMA encoder.

- Transfer bit rate: MP3: 8 —320 kbps
WMA: 48 —192 kbps
- Sampling frequency
MP3: 8, 11.025, 12, 16, 22.05, 24, 32, 44.1, 48 kHz
WMA: 32, 44.1, 48 kHz

When you use your CD writer to record MP3/WMA up to the maximum disc capacity, disable additional writing. For recording on an empty disc up to the maximum capacity at once, check Disc at Once.



- Play mode may not be possible when portions of the functions of Windows Media Player 9 or higher are used.

Entering ID3 tag

The Displayable ID3 tag is ID3 version 1.x.

For the character code, refer to the List of Codes.

0	1	2	3	4	5	6	7	8	9	A	B	C	D	E	F		
			0	@	P	i	p			■	°	À	Á	Â	Ã		
1			!	1	A	Q	a	q				ì	±	Ä	N	ä	ñ
2			"	2	B	R	b	r				ç	²	Å	Ö	å	ó
3			#	3	C	S	c	s				€	³	Ä	Ö	ä	ô
4			\$	4	D	T	d	t				Ø	⁴	Å	Ö	ä	õ
5			%	5	E	U	e	u				¥	µ	Ä	Ö	ä	ö
6			&	6	F	V	f	v				!	¶	Æ	Œ	æ	±
7			7	7	G	W	g	w				§	-	Œ	Œ	œ	±
8			(8	H	X	h	x				¶	†	É	Ú	é	ú
9)	9	I	Y	i	y				©	†	É	Ú	é	ú
A			*	:	J	Z	j	z				ª	ª	É	Ú	é	ú
B			+	:	K	[k	[»	»	È	Ù	è	ù
C			<	<	L	\	l	\				¼	¼	Ì	Ù	ì	ù
D			=	=	M]	m]				½	½	Ý	Û	ý	Û
E			>	>	N	^	n	^				¾	¾	Þ	Û	þ	Û
F			/	/	?	_	o	■				-	-	Û	Û	Û	Û

Entering file and folder names

The code list characters are the only file names and folder names that can be entered and displayed.

If you use any other character for entry, the file and folder names are not displayed correctly. They may neither be displayed correctly depending on the CD writer used.

The unit recognizes and plays only those MP3/WMA which have the MP3/WMA extension (.MP3/.WMA).



- A file with a name entered with characters not on the code list may not play correctly.

Writing files into a medium

When a medium containing MP3/WMA data is loaded, the unit checks all the data on the medium. If the medium contains a lot of folders or non-MP3/WMA files, therefore, it takes a long time until the unit starts playing MP3/WMA.

In addition, it may take time for the unit to move to the next MP3/WMA file or a File Search or Folder Search may not be performed smoothly.



Loading such a medium may produce loud noise to damage the speakers.

- Do not attempt to play a medium containing a non-MP3/WMA file with the MP3/WMA extension.
The unit mistakes non-MP3/WMA files for MP3/WMA data as long as they have the MP3/WMA extension.
- Do not attempt to play a medium containing non MP3/WMA.

MP3/WMA playing order

When selected for play, Folder Search, File Search, or for Folder Select, files and folders are accessed in the order in which they were written by the CD writer.

Because of this, the order in which they are expected to be played may not match the order in which they are actually played. You may be able to set the order in which MP3/WMA are to be played by writing them onto a medium such as a CD-R with their file names beginning with play sequence numbers such as "01" to "99", depending on your CD writer.

For example, a medium with the following folder/file hierarchy is subject to Folder Search, File Search, or Folder Select as shown below.

Example of a medium's folder/file hierarchy

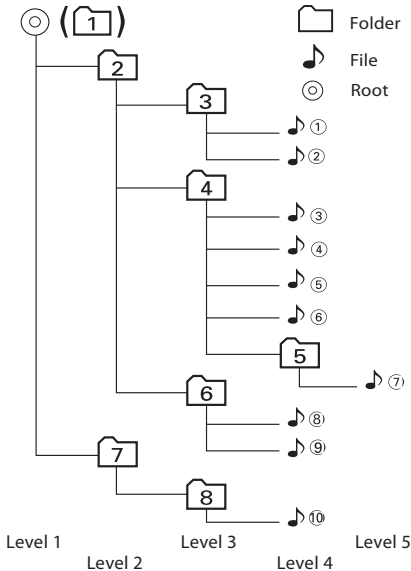

When a File Search is executed with file ④ being played ...

Operation of the button	(Current file: ④)
⏮ Button	Beginning of file ④ → ③
⏭ Button	⑤ → ⑥

When a Folder Search is executed with file ④ being played ...

Operation of the button	(Current folder: ④)
AM Button	③ → ② → ① → ⑧ ...
FM Button	⑤ → ⑥ → ⑦ → ⑧ → ① ...

When Folder Select is selected with file ④ being played to move from folder to folder ...

Operation of the button	(Current folder: ④)
⏮ Button	③
⏭ Button	⑥
AM Button	②
FM Button	⑤

Notes on Sound Management System

The KDC-X979 allows you to set up the best sound field to your car using the audio setup. This is the Sound Management System.

There are two types of audio setup mode: Easy audio setup (called Easy mode) and Professional audio setup (called PRO mode).

Audio setup (Easy mode)

When you select the cabin size and the speaker type you are using in the easy audio setup (Easy mode), you can set the best sound field to your car automatically.



- Refer to 'Audio Setup (Easy mode)' (page 28).

Audio setup (PRO mode)

While in the professional audio setup (PRO mode), you can fine-tune and memory the X'Over (Cross-over), DTA (Digital Time Alignment), and EQ (Equalizer), controls in addition to the sound quality you have set in the audio setup (Easy mode).



- Refer to 'Audio Setup (PRO mode)' (page 28).

First, set up the sound field in your car by 'Audio setup (Easy mode)' (page 28). Proceed to the following steps for sound field setup.

1. Enter Audio Setup mode.
Press the [NEXT] button.
Repeatedly press the button until "AD SET" is displayed above the [3] button.
Refer to 'Notes on Multi-function Key System' (page 9).
 2. Set the cabin size of your car.
Press the [2] ("CABIN") button.
 3. Select the cabin size of your car.
Press the [◀◀] or [▶▶] button.
 4. Select a speaker
Press the [3] ("SP-SEL") button.
 5. Set up the speaker
Press the [2] — [5] button.
- 
- For the speakers you can set up using buttons [2] to [5], see the 'Audio setup (Easy mode)' (page 28).
6. Select the speaker size.
Press the [◀◀] or [▶▶] button.
 7. Exit Audio setup mode
Press the [6] ("RTN") button.

Now, you can create the best sound field to your car.

For the detailed speaker setup, see the 'Audio Setup (PRO mode)' (page 28).

General features

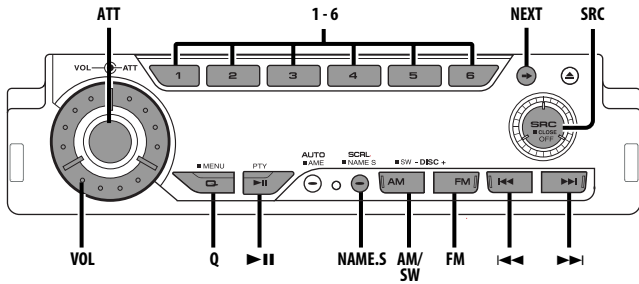

Power

Turning ON the Power

Turn the vehicle ignition ON.

The panel appears.

Turning OFF the Power

Turn the vehicle ignition OFF or press the [SRC] button for at least 1 second.

The panel hides.



- Do not apply force to the panel during operation. It can cause damage.

Hiding the Control Panel

Prevents tampering with the unit while your car is being serviced etc.

Hiding the control panel

Press the [SRC] button for at least 1 second.

When the time set in 'OFF Wait Time Setting' (page 48) lapses, the panel is hidden and the power turns OFF.

Showing the control panel

Press the left part at the lower side of the panel.

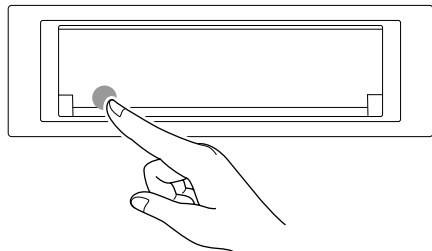

The panel is opened to enable the operation.

General features

Selecting the Source

Press the [SRC] button.

Source required	Display
SIRIUS tuner (Optional accessory)	"SIRIUS"
Tuner or HD Radio (Optional accessory)	"TUNER" or "HD RADIO"
CD	"Compact Disc"
External disc (Optional accessory)	"CD Changer"
Auxiliary input	"AUX"
Standby (Illumination only mode)	"STANDBY"

Volume

Increasing Volume

Turn the [VOL] knob clockwise.

Decreasing Volume

Turn the [VOL] knob counterclockwise.

Attenuator

Turning the volume down quickly.

Press the [ATT] button.

Each time the button is pressed the Attenuator turns ON or OFF.

When it's ON, "ATT" is displayed.

Rotary Volume knob operation mode select

The rotary volume knob can be used for volume adjustment and various function setups.

Available setup functions

The rotary volume knob can be used for the following setup:

- Menu system : Item selection
- Audio Control : Adjustment of setup value
- Audio Setup : Adjustment of setup value
- Display control : Display switching
- Station/Disc Naming : Character selection
- Folder select : Folder search



- You can select the Rotary Volume Operation mode only when the "Rotary" indicator is displayed above the [1] button during any function setup.
- When the "Rotary" indicator is ON, you cannot use the rotary volume control for function setup and sound level adjustment.

To use the rotary volume knob:

1 Turn the rotary volume operation ON

See the 'Rotary volume operation select' (52 page) and select "Rotary SEL: ON".

2 Selecting the Rotary Volume Operation mode

Press the [1] button.

When it's ON, the "Rotary" indicator blinks.

3 Setting the function

Rotate the Rotary Volume knob.

4 Terminates the function setup using the rotary volume knob

Press the [1] button.

TEL Mute

The audio system automatically mutes when a call comes in.

When a call comes in

"CALL" is displayed.

The audio system pauses.

Listening to the audio during a call

Press the [SRC] button.

The "CALL" display disappears and the audio system comes back ON.

When the call ends

Hang up the phone.

The "CALL" display disappears and the audio system comes back ON.

Display Mode Switching

Switching the display mode.

1 Select the key function section

Press the [NEXT] button.

Repeatedly press the button until "DISP" is displayed above the [3] (KDC-MP925/X879)/ [4] (KDC-X979) button.

Refer to 'Notes on Multi-function Key System' (page 9).



2 Enter display control mode

Press the [3] ("DISP") (KDC-MP925/X879)/ [4] ("DISP") (KDC-X979) button.

3 Select the display mode

Press the [2] ("MODE") button.

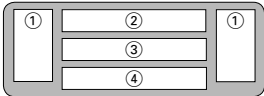
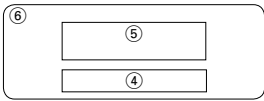
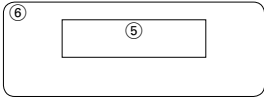
Each time the button is pressed the display mode switches as shown below.

Display Mode	Display
"Display:A"	
"Display:B"	
"Display:C"	
"Display:D"	

- ① Side graphic part
- ② Upper text display part
- ③ Lower text display part
- ④ Function item display
- ⑤ Text display part
- ⑥ Graphic & spectrum analyzer display part

4 Exit display control mode

Press the [6] ("RTN") button.



- No function item is displayed if "Display:C" or "Display:D" is selected. To use a function item, press any of [1] to [6] buttons or [NEXT] button. The function item will be displayed approximately 5 seconds.

- When the 'Dual Zone System' (page 25) is ON, the spectrum analyzer cannot be displayed.
- The display is dimmed during "Display:B" or "Display:C" mode.
- The indicator appears only when the Clock is displayed in the upper or lower position during "Display:A" mode.

Display:A

Side Graphic Display Switching

Switching the Side graphic Display.

1 Select the key function section

Press the [NEXT] button.

Repeatedly press the button until "DISP" is displayed above the [3]/ [4] button.

Refer to 'Notes on Multi-function Key System' (page 9).

2 Enter display control mode

Press the [3]/ [4] ("DISP") button.

3 Select the display mode

Press the [2] ("MODE") button.

Select the "Display:A" display.

4 Enter display control mode

Press the [4] ("SIDE") button.

"Side Graphic" is displayed.

5 Select the side graphic display

Press the [◀◀] or [▶▶] button.

Each time the button is pressed the side graphic display switches as shown below.

Side graphic display
Text + Source
Graphic 1
⋮
Graphic 3
Spectrum analyzer 1
⋮
Spectrum analyzer 4
Blank

6 Exit display control mode

Press the [6] ("RTN") button.



- The setting of this function is available while "Display:A" is selected for the Display mode.

General features

Display:A

Text Display Switching

Switching the text display.

1 Select the key function section

Press the [NEXT] button.

Repeatedly press the button until "DISP" is displayed above the [3]/ [4] button.

Refer to 'Notes on Multi-function Key System' (page 9).

2 Enter display control mode

Press the [3]/ [4] ("DISP") button.

3 Select the display mode

Press the [2] ("MODE") button.

Select the "Display:A" display.

4 Enter text select mode

Press the [3] ("TEXT") button.



- In the Rotary Volume Operation mode, you can select the Upper part or Lower part using button [3] ("TEXT") and switch the display using the rotary volume key.

5 Select the text in the upper text display part

Press the [FM] or [AM] button.

Select the text in the lower text display part

Press the [◀◀] or [▶▶] button.

Refer to the table described later for setting items.

6 Exit Display Control mode

Press the [6] ("RTN") button.



- The setting of this function is available while "Display: A" is selected for the Display mode.
- Upper text display part cannot display the same information as Lower text display part.
- The Album name cannot be displayed during WMA play.

The text display in the Upper text display part

In Tuner source

Information	Display
Station name	"BAND+ch+SNPS"
Radio text or Frequency	"R-TEXT"
Frequency	"BAND+ch+FREQ"
Date	"DATE"
Clock	"CLOCK"
Spectrum Analyzer & Clock	"S/ANA+CLOCK"

In CD & External disc source

Information	Display
Disc title	"DISC-TITLE"
Track title	"TRACK-TITLE"
Track number & Play time	"P-Time"
Disc name	"DNPS"
Date	"DATE"
Clock	"CLOCK"
Spectrum Analyzer & Clock	"S/ANA+CLOCK"

In MP3/WMA source

Information	Display
Song title & Artist name	"TITLE/ARTIST"
Album name & Artist name	"ALBUM/ARTIST"
Folder name	"FOLDER NAME"
File name	"FILE NAME"
Play time & File number	"P-Time"
Date	"DATE"
Clock	"CLOCK"
Spectrum Analyzer & Clock	"S/ANA+CLOCK"

In Standby

Information	Display
Standby (Illumination only mode)	"STANDBY"
Date	"DATE"
Clock	"CLOCK"

In Auxiliary input source

Information	Display
Auxiliary input name	"AUX NAME"
Date	"DATE"
Clock	"CLOCK"
Spectrum Analyzer & Clock	"S/ANA+CLOCK"

In HD Radio source

Information	Display
Station name	"Station Name"
Title	"Title"
Frequency	"Frequency"
Date	"DATE"
Clock	"CLOCK"
Spectrum Analyzer & Clock	"S/ANA+CLOCK"

In SIRIUS tuner source

Information	Display
Channel Name	"Channel Name"
Song Title	"Song Title"
Artist Name	"Artist Name"
Composer name	"Composer Name"
Category Name	"Category Name"

Label	"Label Name"
Comment	"Comment"
Band & Channel Number	"Channel Number"
Date	"DATE"
Clock	"CLOCK"
Spectrum Analyzer & Clock	"S/ANA+CLOCK"



- If the Disc title, Track title, Song title & Artist name, or Album name & Artist name is selected when the disc which does not have Disc title, Track title, Song title, Album name, or Artist name is played, track number and play time are displayed.
- If the text for the Sirius tuner source, including Channel name, etc. is selected when the channel which does not have text for the Sirius tuner source, including Channel name, etc. is played, band & channel number is displayed.

The text display in the Lower text display part

In Tuner source

Information	Display
KENWOOD Logo	"LOGO"
Clock	"CLOCK"
Spectrum Analyzer & Clock	"S/ANA+CLOCK"
Radio text or Frequency	"R-TEXT"
Date	"DATE"

In CD & External disc source

Information	Display
KENWOOD Logo	"LOGO"
Clock	"CLOCK"
Spectrum Analyzer & Clock	"S/ANA+CLOCK"
Disc title	"DISC-TITLE"
Track Title	"TRACK-TITLE"
Disc name	"DNPS"
Date	"DATE"

In MP3/WMA source

Information	Display
KENWOOD Logo	"LOGO"
Clock	"CLOCK"
Spectrum Analyzer & Clock	"S/ANA+CLOCK"
Song title & Artist name	"TITLE/ARTIST"
Album name & Artist name	"ALBUM/ARTIST"
Folder name	"FOLDER NAME"
File name	"FILE NAME"
Date	"DATE"

In Standby

Information	Display
KENWOOD Logo	"LOGO"
Clock	"CLOCK"
Date	"DATE"

In Auxiliary input source

Information	Display
KENWOOD Logo	"LOGO"
Clock	"CLOCK"
Spectrum Analyzer & Clock	"S/ANA+CLOCK"
Date	"DATE"

In HD Radio source

Information	Display
KENWOOD Logo	"LOGO"
Clock	"CLOCK"
Spectrum Analyzer & Clock	"S/ANA+CLOCK"
Station name	"Station Name"
Title	"Title"
Date	"DATE"

In SIRIUS tuner source

Information	Display
KENWOOD Logo	"LOGO"
Clock	"CLOCK"
Spectrum Analyzer & Clock	"S/ANA+CLOCK"
Channel Name	"Channel Name"
Song Title	"Song Title"
Artist Name	"Artist Name"
Composer name	"Composer Name"
Category Name	"Category Name"
Label	"Label Name"
Comment	"Comment"
Date	"DATE"



- If 'Dual Zone System' (page 25) is turned ON while the spectrum analyzer is displayed, the spectrum analyzer disappears from the display.
- If the Disc title, Track title, Song title & Artist name, or Album name & Artist name is selected when the disc which does not have Disc title, Track title, Song title, Album name, or Artist name is played, Kenwood Logo are displayed.
- If the text for the Sirius tuner source, including Channel name, etc. is selected when the channel which does not have text for the Sirius tuner source, including Channel name, etc. is played, Kenwood Logo are displayed.

General features

Display:B/ Display:C/ Display:D

Graphic part/ Spectrum Analyzer Display Switching

Switching the graphic Display/ Spectrum analyzer display.

1 Select the key function section

Press the [NEXT] button.

Repeatedly press the button until "DISP" is displayed above the [3]/ [4] button.

Refer to 'Notes on Multi-function Key System' (page 9).

2 Enter display control mode

Press the [3]/ [4] ("DISP") button.

3 Select the display mode

Press the [2] ("MODE") button.

Select the "Display:B"/ "Display:C"/ "Display:D" display.

4 Select the graphic/ spectrum analyzer display

Press the [4] ("SA-grph") button.

5 Select the graphic/ spectrum analyzer display part display

Press the [◀◀] or [▶▶] button.

Each time the button is pressed the graphic display/ spectrum analyzer display switches as shown below.

Graphic display/ Spectrum Analyzer display

Movie 1

Movie 2

*Downloaded movie

Spectrum analyzer 1

⋮

Spectrum analyzer 5

Wallpaper

• * Function of the KDC-X979

6 Exit display control mode

Press the [6] ("RTN") button.



• The setting of this function is available while "Display : B"/ "Display:C"/ "Display:D" is selected for the Display mode.

Display:B/ Display:C/ Display:D

Wallpaper selecting

Select a wallpaper to display when Display Type is set to "Display:B"/ "Display:C"/ "Display:D".

1 Select the wallpaper display

Refer to 'Graphic part/ Spectrum Analyzer Display Switching' (page 18).

2 Select the wallpaper

Display the wallpapers one after another and select one

1 Turn the wallpaper scan ON.

Press the [▶II] button.

Each time the button is pressed the Wallpaper scan is turned ON and OFF.

When it's ON, "SCAN" is displayed.

When it's ON, each wallpaper is displayed every several seconds.

2 At the wallpaper you want to display.

Press the [▶II] button.

Select wallpaper manually

1 Turn the wallpaper scan OFF.

Press the [▶II] button.

Each time the button is pressed the Wallpaper scan is turned ON and OFF.

2 Select the wallpaper.

Press the [FM] or [AM] button.

Each time the button is pressed the wallpaper changes.

3 Exit Display Control mode

Press the [6] ("RTN") button.

Display:B/ Display:C

Text Display Switching

Switching the text display.

1 Select the key function section

Press the [NEXT] button.

Repeatedly press the button until "DISP" is displayed above the [3]/ [4] button.

Refer to 'Notes on Multi-function Key System' (page 9).

2 Enter display control mode

Press the [3]/ [4] ("DISP") button.

3 Select the display mode

Press the [2] ("MODE") button.

Select the "Display:B"/ "Display:C" display.

4 Select the text

Press the [3] ("TEXT") button.



- It can also be switched by pressing either [◀◀] or [▶▶] button.

In Tuner source

Information	Display
Station name	"BAND+ch+SNPS"
Radio text or Frequency	"R-TEXT"
Frequency	"BAND+ch+FREQ"
Date	"DATE"
Clock	"CLOCK"

In CD & External disc source

Information	Display
Disc title (In External disc source)	"DISC-TITLE"
Track title	"TRACK-TITLE"
Track number & Play time	"P-Time"
Disc name	"DNPS"
Date	"DATE"
Clock	"CLOCK"

In MP3/WMA source

Information	Display
Song title & Artist name	"TITLE/ARTIST"
Album name & Artist name	"ALBUM/ARTIST"
Folder name	"FOLDER NAME"
File name	"FILE NAME"
Play time & File number	"P-Time"
Date	"DATE"
Clock	"CLOCK"

In Auxiliary input source

Information	Display
Auxiliary input name	"AUX NAME"
Date	"DATE"
Clock	"CLOCK"

In HD Radio source

Information	Display
Station name	"Station Name"
Title	"Title"
Frequency	"Frequency"
Date	"DATE"
Clock	"CLOCK"

In Standby

Information	Display
Standby (Illumination only mode)	"STANDBY"
Date	"DATE"
Clock	"CLOCK"

In SIRIUS tuner source

Information	Display
Channel Name	"Channel Name"
Song Title	"Song Title"
Artist Name	"Artist Name"
Composer name	"Composer Name"
Category Name	"Category Name"
Label	"Label Name"
Comment	"Comment"
Band & Channel Number	"Channel Number"
Date	"DATE"
Clock	"CLOCK"

5 Exit Display Control mode

Press the [6] ("RTN") button.



- If the Disc title, Track title, Song title & Artist name, or Album name & Artist name is selected when the disc which does not have Disc title, Track title, Song title, Album name, or Artist name is played, track number and play time are displayed.
- If the text for the Sirius tuner source, including Channel name, etc. is selected when the channel which does not have text for the Sirius tuner source, including Channel name, etc. is played, band & channel number is displayed.

General features

Station/Disc Naming (SNPS/DNPS)

Attaching a title to a Station or CD.

1 Receive/play the station/disc you want to attach a title to



- A title can't be attached to MD or MP3/WMA media.
- Refer to the "Text Display Switching" (page 16/18) and select either "DNPS" or "SNPS". No name can be attached to the source if "DNPS" or "SNPS" cannot be selected for it.

2 Enter name set mode

Press the [NAME.S] button for at least 2 seconds.

"NAME SET" is displayed.

3 Move the cursor to the enter character position

Press the [◀◀] or [▶▶] button.

4 Select the character type

Press the [2] — [4] button.

Each time the button is pressed the character type switches as shown below.

Character type	Button
Alphabet (Upper case/ Lower case)	[2] ("A · a")
Numbers and symbols	[3] ("1")
Special characters (Accent characters)	[4] ("CHAR")

5 Select the characters

Press the [FM] or [AM] button.



- Characters can be entered by using a remote with a number buttons.
Example: If "DANCE" is entered.

Character	Button	Times pressed
"D"	[3]	1
"A"	[2]	1
"N"	[6]	2
"C"	[2]	3
"E"	[3]	2

6 Repeat steps 3 through 5 and enter the name.

7 Exit name set mode

Press the [NAME.S] button.



- When operation stops for 10 seconds the name at that time is registered, and Name Set mode closes.
- Memory numbers
 - FM: 32 stations
 - AM: 16 stations
 - Internal CD player: 30 discs
 - External CD changer/ player: Varies according to the CD changer/ player. Refer to the CD changer/ player manual.
- The title of station/CD can be changed by the same operation used to name it.

Auxiliary Input Display Setting

Selecting the display when this device is switched to Auxiliary input source.

1 Select Auxiliary input source

Press the [SRC] button.

Select the "AUX" display.

2 Enter Auxiliary input display setting mode

Press the [NAME.S] button for at least 2 seconds.

The presently selected AUX Name is blinks.

3 Select the Auxiliary input display

Press the [◀◀] or [▶▶] button.

Each time the button is pressed it switches through the below displays.

- "AUX"
- "TV"
- "VIDEO"
- "GAME"
- "PORTABLE"
- "DVD"

4 Exit Auxiliary input display setting mode

Press the [NAME.S] button.



- When operation stops for 10 seconds, the name at that time is selected, and Auxiliary input display setting mode closes.
- The Auxiliary Input Display can be set only when the built-in auxiliary input or the auxiliary input of optional KCA-S210A is used.

Panel Position Setting

Setting the angle or back-forward position of the control panel.

1 Select the key function section

Press the [NEXT] button.

Repeatedly press the button until "PNL" is displayed above the [4]/ [5] button.

2 Enter Panel Position Setting mode

Press the [4] ("PNL") (KDC-MP925/X879)/ [5] ("PNL") (KDC-X979) button.

3 Select the item for adjustment

Press the desired [2] — [5] button.

Each time the button is pressed the items that can be adjusted switch as shown below.

Adjustment Item	Button	Display
The panel tilts upwards.	[2]	"ANG—"
The panel tilts downwards.	[3]	"ANG+"
The panel slides backward.	[4]	"SLD—"
The panel slides forward.	[5]	"SLD+"

4 Exit Panel Position Setting mode

Press the [6] ("RTN") button.



- The control panel may be interfered with the shift lever or another part depending on the angles of the control panel.
Set the angle to avoid any interference.
- When a hard rubber frame is mounted
Do not use with the panel slid in the forward direction.
If so, the hard rubber frame will interfere with the panel when the angle is adjusted downward.
- No sound is produced while the panel is operating.

Theft Deterrent Panel

The Backpanel of the unit can be detached and taken with you, helping to deter theft.

Removing the Backpanel

1 Turn the ignition OFF or press the [SRC] button for at least 1 second.

Turn OFF the power, and the control panel becomes horizontal.



- After the set time passes in 'OFF Wait Time Setting' (page48), the panel is closed.

2 Remove the Backpanel forward.

When 'DSI (Disabled System Indicator)' (page47) is set to ON, DSI blinks.

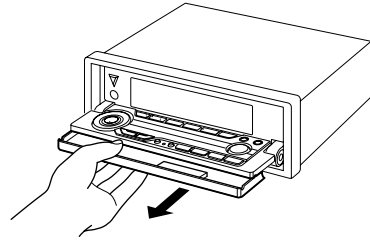

- The back panel is a precision piece of equipment and can be damaged by shocks or jolts. For that reason, keep the back panel in its special storage case while detached.
- Do not expose the Backpanel or its storage case to direct sunlight or excessive heat or humidity. Also avoid places with too much dust or the possibility of water splashing.

Reattaching the Backpanel

1 Set the Backpanel to the panel bracket.

2 Hold down on the Backpanel until it is locked.

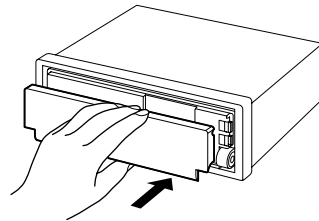

General features

Function of the KDC-MP925/KDC-X879

Audio Control

1 Select the source for adjustment

Press the [SRC] button.

2 Select the key function section

Press the [NEXT] button.

Repeatedly press the button until "AUD" is displayed above the [2] button.

Refer to 'Notes on Multi-function Key System' (page 9).

3 Enter Audio Control mode

Press the [2] ("AUD") button.

4 Select the Adjustment item section

Press the [NEXT] button.

Repeatedly press the button until the desired Adjustment item is displayed above the [2] — [5] button.

1st section

Adjustment Item	Button	Display
Bass	[2]	"BASS"
Middle	[3]	"MID"
Treble	[4]	"TRE"
WOW	[5]	"WOW"

2nd section

Adjustment Item	Button	Display
Subwoofer*	[2]	"SW"
High Pass Filter	[3]	"HPF"
Low Pass Filter*	[4]	"LPF"
Loudness	[5]	"LOUD"

3rd section

Adjustment Item	Button	Display
Balance & Fader	[2]	"BL/F"
Volume offset	[3]	"VOFF"

5 Select the Audio Control item for adjustment

Press the [2] — [5] button.

Each time the [2] — [5] button is pressed the adjustable audio items are switched among ranges of all stage section's tables on the following pages.

6 Adjust the Audio Control item

Press the [◀◀] or [▶▶] button.

Each time the button is pressed the setting switches as shown below.



- The Adjustment item can also be controlled by the rotary volume knob. Refer to 'Rotary Volume knob operation mode select'(page 14).

7 Exit Audio Control mode

Press the [6] ("RTN") button.



- The loudness setting can also be adjusted by pressing the [5] button.
- WOW can be set when SRS WOW or User memory is selected at 'System Q' (KDC-MP925/ X879) (page 24).
- The Loudness can not be set when SRS WOW is selected at 'System Q' (KDC-MP925/ X879) (page 24).
- *This mode is available only when 'Subwoofer Output' (page 23) is ON.

1st section

[2] button

Adjustment Item	Display	Range
Bass Center Frequency*	"BASS F"	60/70/80/100 or 150 Hz
Bass level	"BASS L"	-8 — +8 dB
Bass Q Factor*	"BASS Q"	1.00/1.25/1.50/2.00
Bass Extend*	"BASS Ext"	ON/OFF

[3] button

Adjustment Item	Display	Range
Middle Center Frequency*	"MIDDLE F"	0.5/1.0/1.5/2.0 kHz
Middle level	"MIDDLE L"	-8 — +8 dB
Middle Q Factor*	"MIDDLE Q"	1.0/2.0

[4] button

Adjustment Item	Display	Range
Treble Center Frequency*	"TREBLE F"	10.0/12.5/15.0/17.5 kHz
Treble level	"TREBLE L"	-8 — +8 dB

[5] button

Adjustment Item	Display	Range
SRS WOW	"SRS WOW"	OFF/LOW/HIGH
FOCUS	"FOCUS"	OFF/LOW/HIGH
TruBass	"TruBass"	ON/OFF
SRS 3D	"SRS 3D"	ON/OFF



- * Function of the KDC-X879
- According to the Bass Q Factor setting value, the frequencies that can be set in Bass Center Frequency change as shown below.

Bass Q Factor	Bass Center Frequency
1.00/1.25/1.50	60/70/80/100
2.00	60/70/80/150

- When the bass extend is set to ON, low frequency response is extended by 20%.
- WOW: TruBass, FOCUS and SRS 3D are all set to values shown below.

WOW	TruBass	FOCUS	SRS 3D
High	ON	High	ON
Low	ON	Low	ON
OFF	OFF	OFF	OFF

- TruBass: Assisting the playback for the super bass sound.
- FOCUS: Adjusts the sound image by changing the vertical position of the speakers virtually and increases or decreases the soundscape.
- SRS 3D: Making a natural 3D sound field.
- SRS 3D cannot be set in tuner source.

2nd section

[2] button

Adjustment Item	Display	Range
Subwoofer level	"SW LEVEL"	-15 — +15
Subwoofer phase	"PHASE"	Normal (0°)/Reverse (180°)

[3] button

Adjustment Item	Display	Range
Front High Pass Filter	"X"OVER Front"	Through/40/60/80/100/120/150/180/220 Hz
Rear High Pass Filter	"X"OVER Rear"	Through/40/60/80/100/120/150/180/220 Hz

[4] button

Adjustment Item	Display	Range
Subwoofer Low Pass Filter	"X"OVER Sub Woofer"	50/80/120/Through Hz

[5] button

Adjustment Item	Display	Range
Loudness	"LOUD"	ON/OFF



- Loudness: Compensating for low and high tones during low volume.

3rd section

[2] button

Adjustment Item	Display	Range
Balance	"BL"	Left 15 — Right 15
Fader	"F"	Rear 15 — Front 15

[3] button

Adjustment Item	Display	Range
Volume offset	"VOL OFFSET"	-8 — 0



- Volume offset: Each source's volume can be set as a difference from the basic volume.

Subwoofer Output

Turning the Subwoofer output ON or OFF.

Press the [SW] button for at least 1 second.

Each time the button is pressed Subwoofer output switches ON or OFF.

When it's ON, "SUB WOOFER ON" is displayed.

General features

Function of the KDC-MP925/KDC-X879

System Q

You can recall the best sound setting preset for different types of music.

1 Select the source to set

Press the [SRC] button.

2 Select the Sound type

Press the [Q] button.

Each time the button is pressed the sound setting switches.

Sound setting	Display
SRS WOW	"SRS WOW"
Natural	"Natural"
User memory	"USER"
Rock	"ROCK"
Pops	"POPS"
Easy	"EASY"
Top 40	"TOP 40"
Jazz	"JAZZ"



- User memory: The values set on the 'Audio Control' (page 22).
- Each setting value is changed with the 'Speaker Setting' (page 24).
First, select the speaker type with the Speaker setting.
- When 'Dual Zone System' (page 25) is set to ON, the setting of SRS WOW is disabled.

Function of the KDC-X979

System Q

You can recall the best sound setting preset for different types of music.

1 Select the source to set

Press the [SRC] button.

2 Select the Sound type

Press the [Q] button.

Each time the button is pressed the sound setting switches.

Sound setting	Display
Natural	"Natural"
Rock	"ROCK"
Pops	"POPS"
Easy	"EASY"
Top 40	"TOP 40"
Jazz	"JAZZ"
User memory	"USER"
Installer	"INSTALLER"



- User memory: The values set on the 'Audio Setup (PRO mode)' (page 28).
- Installer: The values set on the 'Audio Setup (PRO mode)' (page 28).
- Each setting value is changed with the 'Audio Setup (PRO mode)' (page 28).
First, select the Cabin size and the speaker type with 'Audio Setup (Easy mode)' (page 28). Refer to 'Notes on Sound Management System' (page 12).

Function of the KDC-MP925/KDC-X879

Speaker Setting

Fine-tuning so that the System Q value is optimal when setting the speaker type.

1 Enter Standby

Press the [SRC] button.

Select the "STANDBY" display.

2 Enter Speaker Setting mode

Press the [Q] button.

"SP SELECT" is displayed.

3 Select the Speaker type

Press the [2] — [5] button.

Each time the button is pressed the setting switches as shown below.

Speaker type	Button	Display
OFF	[2]	"OFF"
For 5 & 4 in. speaker	[3]	"5/4"
For 6x9 & 6 in. speaker	[4]	"6*9/6"
For the OEM speaker	[5]	"OEM"

4 Exit Speaker Setting mode

Press the [Q] button.

In SIRIUS Tuner, External disc, or Auxiliary input source

Dual Zone System

Makes the sound different for the front channel and rear channel.

Output the Internal source sound from either one of the front or rear channels, and the sound of other source from the Dual zone channel.

1 Select the source

Press the [SRC] button.

Select the source sound to be output from the Dual zone channel.

2 Select the key function section

Press the [NEXT] button.

Repeatedly press the button until "2-ZN" is displayed above the [5]/ [2] button.

Refer to 'Notes on Multi-function Key System' (page 9).

3 Enter the Dual Zone System Control mode

Press the [5] ("2-ZN") (KDC-MP925/X879)/ [2] ("2-ZN") (KDC-X979) button.

4 Select the item for adjustment

Press the desired [2] — [3] button.

Each time the button is pressed the items that can be adjusted switch as shown below.

Adjustment Item	Button	Display	Range
Dual Zone System	[2]	"ON/OFF"	ON/OFF
Dual Zone System Front & Rear	[3]	"F ↔ R"	Front/Rear



Dual Zone System Rear:

The front is this unit's internal source, and the rear is selected source sound.

Dual Zone System Front:

The rear is this unit's internal source, and the front is selected source sound.

5 Exit the Dual Zone System Control mode

Press the [6] ("RTN") button.

6 Select the source

Press the [SRC] button.

Select the source sound to be output from the internal source channel.



- The Dual Zone System can be used with the sources shown below.
 - Internal auxiliary input
 - KCA-S210A
 - CA-C1AX
 - External disc changer/ player
 - SIRIUS satellite radio tuner
- While Dual Zone System is ON, the setting of Dual Zone System Front or Rear is disabled. Set Dual Zone System Front or Rear first, and then set the Dual Zone System to ON.
- When the Dual Zone System is ON, there is no Dual zone channel audio control or other effect.
- When you use the Dual Zone System by selecting the optional accessory source for the output of the Dual zone channel, you cannot select another optional accessory source as the source for the Internal source channel.
- When "SRS WOW" is selected at 'System Q' (KDC-MP925/ X879) (page 24) the Dual Zone System cannot be turned on and off. Also set all the 'Audio Control' (KDC-MP925/ X879) (page 22) WOW items to OFF. The Dual Zone System cannot be turned on and off if even one of the items is set to ON.
- The Dual Zone System cannot be used if a DAB control unit is connected.
- When the 'Dual Zone System' is ON, each of the following setup is ignored.
 - "WOW"/ "PLII"/ "POSI"/ "PHASE" ('Audio control' (KDC-X979) (page 26))
 - "X'over"/ "EQ"/ "DTA" ('Audio Setup (PRO mode)' (page 28))
 - System Q
 - ('System Q' (KDC-X979) (page 24))
 - WOW/ X'OVER ('Audio Control' (KDC-MP925/X879) (page 22))
- The Dual Zone System can be used only when you have set the rear speaker to any mode other than "None" in the 'Audio Setup (Easy mode)' (page 28).

Sound management features

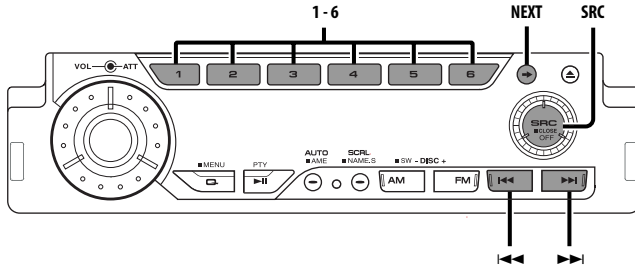

Audio control

1 Select the source for adjustment

Press the [SRC] button.

2 Select the key function section

Press the [NEXT] button.

Repeatedly press the button until "AD CTRL" is displayed above the [2] button.

Refer to 'Notes on Multi-function Key System' (page 9).

3 Enter Audio Control mode

Press the [2] ("AD CTRL") button.

4 Select the Adjustment item section

Press the [NEXT] button.

Repeatedly press the button until the desired Adjustment item is displayed above the [2] — [5] button.

5 Select the Audio Control item for adjustment

Press the [2] — [5] button.

Each time the [2] — [5] button is pressed the adjustable audio items are switched among

ranges of all stage section's tables on the following pages.

1st section

Multi-function key operation	Audio control item
[2] "PLII"	Dolby ProLogic II setting
[3] "WOW"	SRS WOW setting
[4] "OFF"	OFF setting
[5] "FINE"	[2] "PNRM" Panorama setting [3] "DIM" Dimension control [4] "CT-WDTH" Center width control
	[2] "FOCUS" FOCUS setting [3] "TruBass-F" SRS TruBass Front setting [3] "TruBass-R" SRS TruBass Rear setting [4] "SRS 3D" SRS 3D setting



- When you select the "MUSIC" using "PLII", you can set the "PNRM", "DIM" and "CT-WDTH" using the "FINE" function. Also, when you select the "WOW", you can set the "FOCUS", "TruBass-F/TruBass-R", and "SRS 3D" using the "FINE" function.

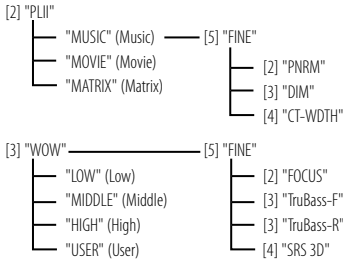

2nd section

Multi-function key operation	Audio control item
[2] "POSI"	Position setting
[3] "BL/F"	Balance setting
[3] "BL"	Fader setting
[3] "F"	
[4] "VOFF"	Volume offset
[5] "SW**"	Subwoofer level
[5] "SW LEVEL"	
[5] "PHASE"	Subwoofer Phase setting



- Volume offset: Each source's volume can be set as a difference from the basic volume.
- * You can control this item when 'Subwoofer Output' (page 23) is set to "SUB WOOFER ON". Note that you can control it only when "SP-LEV" is set to any item other than "None" by 'Audio Setup (Easy mode)' (page28).

6 Adjust the Audio Control item

Press the [◀◀] or [▶▶] button.

Each time the button is pressed the setting switches as shown below.

1st section

Audio Control Item	Range
Dolby ProLogic II setting	MUSIC/ MOVIE/ MATRIX
SRS WOW setting	LOW/ MIDDLE/ HIGH/ USER
OFF setting	Through/ Bypass
Panorama setting	ON/ OFF
Dimension control	R3 — R1/ Neutral/ F1 — F3
Center width control	0 — 7
FOCUS setting	OFF/ 1 — 9
SRS TruBass Front setting	OFF/ 1 — 4
SRS TruBass Rear setting	
SRS 3D setting	OFF/ 1 — 4

2nd section

Audio Control Item	Range
Position setting	ALL/ Front-L/ Front-R/ Front
Balance setting	L15 — R15
Fader setting	R15 — F15
Volume offset	-8 — 0
Subwoofer level	-10 — +10
Subwoofer Phase setting	Normal/ Reverse



- The Adjustment item can also be controlled by the rotary volume knob. Refer to 'Rotary Volume knob operation mode select' (page 14).
- When the 'Dual Zone System' (page 25) is ON, each of the following setup is ignored.
 - "WOW"/ "PLII"/ "POSI"/ "PHASE"
- WOW: TruBass, FOCUS and SRS 3D are all set to values shown below.

WOW	FOCUS	TruBass	SRS 3D
HIGH	8	4	4
MIDDLE	6	3	2
LOW	3	2	1

- FOCUS: Adjusts the sound image by changing the vertical position of the speakers virtually and increases or decreases the soundscape.
- TruBass: Assisting the playback for the super bass sound.
- SRS 3D: Making a natural 3D sound field.
- SRS 3D cannot be set in tuner source.
- The Dimension Control can be set only when the rear speaker is ON.
- The Center Width Control can be set only when the center speaker is ON.
- Before you set the "TruBass-F"/ "TruBass-R" to get the best sound, set the speaker size using the 'Audio Setup (Easy mode)' (page 28) function. Refer to 'Notes on Sound Management System' (page 12).

7 Exit Audio Control mode

Press the [6] ("RTN") button.

Sound management features

Audio Setup (Easy mode)

1 Selects the Easy mode of Audio setup

See the 'Audio Setup' (page 48) and select "Audio Setup: Easy".

2 Select the source for adjustment

Press the [SRC] button.

3 Select the key function section

Press the [NEXT] button.

Repeatedly press the button until "AD SET" is displayed above the [3] button.

Refer to 'Notes on Multi-function Key System' (page 9).

4 Enter Audio Setup mode

Press the [3] ("AD SET") button.

5 Select the Audio Setup item for adjustment

Press the [2] — [5] button.

Each time the [2] — [5] button is pressed the adjustable audio items are switched among ranges of all stage section's tables on the following pages.

Multi-function key operation	Audio setup item
[2] "CABIN"	Cabin setting
[3] "SP-SEL"	Speaker select Front Speaker select Rear Speaker select Center Speaker select Subwoofer
[4] "SP-LEV"	Speaker level Front Left Speaker level Front Right Speaker level Rear Left Speaker level Rear Right Speaker level Center Speaker level Subwoofer Speaker level Test tone
[5] "CALL"	Call User Call Insttaller



- You can recall the value you have adjusted in the Audio setup PRO mode by selecting the "CALL". Refer to 'Audio Setup memory Recall' (page 30).
- * You can listen to the "T-TONE" when you have tuned it. The sound level is reduced when "T-TONE" is selected. The sound returns to the normal level when the original source is selected.

6 Adjust the Audio setup item

Press the [◀◀] or [▶▶] button.

Each time the button is pressed the setting switches as shown below.

Audio setup Item	Range
Cabin setting	OFF/ Compact/ Full Size Car/ Wagon1/Wagon2/ MiniVan1/ MiniVan2/ SUV/ MiniVan (Long)
Speaker select Front	O.E.M./ 4/ 5/ 6½/ 6¾/ 7 (inch)/ 4*6/ 5*7/ 6*8/ 6*9/ 7*10
Speaker select Rear	None/ O.E.M./ 4/ 5/ 6½/ 6¾/ 7 (inch)/ 4*6/ 5*7/ 6*8/ 6*9/ 7*10
Speaker select Center	None/ 2¾/ 1*1/16/ 2/ 4/ 5/ 6½/ Over (inch)
Speaker select Subwoofer	6½/ 8/ 10/ 12/ 15 Over (inch)/ None
Speaker level Front Left	-10 — +10
Speaker level Front Right	
Speaker level Rear Left	
Speaker level Rear Right	
Speaker level Center	-10 — +10
Speaker level Subwoofer	



- The Adjustment item can also be controlled by the rotary volume knob. Refer to 'Rotary Volume knob operation mode select' (page 14).
- You can select the Speaker level only when you have set the speaker to anything other than "None" using the "SP-SEL".

7 Exit Audio setup mode

Press the [6] ("RTN") button.

Audio Setup (PRO mode)

1 Selects the PRO mode of Audio setup

See the 'Audio Setup' (page 48) and select "Audio Setup: PRO".

2 Select the Audio Setup item for adjustment

Select an audio setup item you wish to adjust by referring to Step 2-5 of 'Audio Setup (Easy mode)' (page 28).

1st section

Multi-function key operation		Audio setup Item
[2] "X'Over"	[2] "FRONT" [3] "REAR" [4] "CNTR" [5] "SW" [5] "PHASE"	High Pass Filter Front High Pass Filter Rear High Pass Filter Center Low Pass Filter Subwoofer Subwoofer Phase setting
[3] "DTA"	[2] "FRONT" [3] "REAR" [4] "CNTR" [5] "SW"	DTA Front DTA Rear DTA Center DTA Subwoofer
[4] "EQ"	[2] "FRONT" [3] "REAR" [4] "CNTR"	[2] "BASS"* EQ Front Bass setting [3] "MID"* EQ Front Middle setting [4] "TRE"* EQ Front Treble setting [2] "BASS"* EQ Rear Bass setting [3] "MID"* EQ Rear Middle setting [4] "TRE"* EQ Rear Treble setting [2] "BASS"* EQ Center Bass setting [3] "MID"* EQ Center Middle setting [4] "TRE"* EQ Center Treble setting
[5] "SP- LEV"	[2] "FRONT" [3] "REAR" [4] "CT/SW"	[2] "Front-L" SP-LEV Front Left [2] "Front-R" SP-LEV Front Right [3] "Rear-L" SP-LEV Rear Left [3] "Rear-R" SP-LEV Rear Right [4] "Center" SP-LEV Center [4] "Sub Woofer" SP-LEV Subwoofer
*2	[5] "T-TONE"	SP-LEV Test tone



- * The followings can be adjusted each time button [2] "BASS", button [3] "MID" or button [4] "TRE" of "EQ" functions is pressed.
[2]"BASS" : "BASS F" (Bass Center Frequency)
"BASS L" (Bass Level)
"BASS Q" (Bass Q Factor)
[3]"MID" : "MID F" (Middle Center Frequency)
"MID L" (Middle Level)
"MID Q" (Middle Q Factor)
[4]"TRE" : "TRE F" (Treble Center Frequency)
"TRE L" (Treble Level)
"TRE Q" (Treble Q Factor)
- *2 You can listen to the "T-TONE" when you have tuned it. The sound level is reduced when "T-TONE" is selected. The sound returns to the normal level when the original source is selected.
- X'over (Crossover Network Setup)
You can manually set a crossover frequency of speakers.
- DTA (Digital Time Alignment)
Manually set the sound output timing of each channel.
- EQ (Equalizer)
You can manually set the equalizer curve.
- SP-LEV (Speaker Level)
Set the volume at each setup position.

2nd section

Multi-function key operation		Audio setup item
[2] "MEMORY"	[2] "USER" [3] "INST"	User Memory User Insttaller
[3] "CALL"	[2] "USER" [3] "INST"	Call User Call Insttaller



- You can store an adjusted audio setup value by selecting "MEMORY". Also, you can recall it by selecting "CALL". Refer to 'Audio Setup memory Recall' (page 30).

3 Adjust the Audio setup item

Press the [◀◀] or [▶▶] button.

Each time the button is pressed the setting switches as shown below.

Adjustment Item	Range
High Pass Filter Front	Through/30 — 250 (Hz)
High Pass Filter Rear	
High Pass Filter Center	
Low Pass Filter Subwoofer	30 — 250 (Hz)
Subwoofer Phase setting	Normal/ Reverse
DTA Front/DTA Rear/ DTA Subwoofer	0 — 20.33 (feet)
DTA Center	0 — 5.67 (feet)
Bass Center Frequency	60 — 400 (Hz)
Middle Center Frequency	500 (Hz) — 3.15 (KHz)
Treble Center Frequency	4.00 (kHz) — 16.00 (KHz)
Bass Level/ Middle Level/ Treble Level	-9 — +9 dB
Bass Q Factor/ Middle Q Factor/ Treble Q Factor	0.25/ 0.50/ 1.00/ 2.00
SP-LEV Front Left/SP-LEV Front Right	-10 — +10
SP-LEV Rear Left/SP-LEV Rear Right	
SP-LEV Center/SP-LEV Subwoofer	



- The Adjustment item can also be controlled by the rotary volume knob. Refer to 'Rotary Volume knob operation mode select' (page 14).
- To get the best sound, first set the "CABIN" and "SP-SEL" parameters using the 'Audio Setup (Easy mode)' (page 28). Refer to 'Notes on Sound Management System' (page 12).
- When the 'Dual Zone System' (page 25) is ON, each of the following setup is ignored.
- "X'over"/ "EQ" / "DTA"

4 Exit Audio setup mode

Press the [6] ("RTN") button.

Audio Setup Memory (PRO mode)

- 1 Selects the PRO mode of Audio setup**
See the 'Audio Setup' (page 48) and select "Audio Setup: PRO".
- 2 Select the source for adjustment**
Press the [SRC] button.
- 3 Select the key function section**
Press the [NEXT] button.
Repeatedly press the button until "AD SET" is displayed above the [3] button.
Refer to 'Notes on Multi-function Key System' (page 9).
- 4 Enter Audio Setup mode**
Press the [3] ("AD SET") button.
- 5 Select the Adjustment item section**
Press the [NEXT] button.
Repeatedly press the button until the desired Adjustment item is displayed above the [2] — [5] button.
- 6 Select the Audio Setup item for adjustment**
Press the [2] — [5] button.
Adjust the audio setup by referring to the 'Audio Setup (PRO mode)' (page 28).
- 7 Select the Memory item section**
Press the [NEXT] button.
Repeatedly press the button until "MEMORY" is displayed above the [2] button.
- 8 Select the Memory item**
Press the [2] ("MEMORY") button.
- 9 Stores the adjusted audio setup value in memory**
Press the [2] ("USER")/ [3] ("INST") button for at least 2 seconds.
The "MEMORY" display blinks 1 time.
"USER": The values are erased from memory if the battery is removed or if the reset button is pressed.
"INST": The values are held in memory even if the battery is removed or if the reset button is pressed.
- 10 Exit Audio Setup mode**
Press the [6] ("RTN") button.

Audio Setup memory Recall

- 1 Enter Audio Setup mode**
Press the [3] ("AD SET") button.
- 2 Select the Recall section**
Press the [NEXT] button.
Repeatedly press the button until "CALL" is displayed above the [3]/[5] button.
- 3 Call the Audio setup memory and select an item to call the memory value**
Press the [3]/ [5] ("CALL") button.

 - If you have set the Audio Setup to "Audio Setup: PRO" using 'Audio Setup' (page 48), press button [3]. If you have set the Audio Setup to "Audio Setup: Easy", press button [5].
- 4 Recalls the value from memory**
Press the [2] ("USER")/ [3] ("INST") button.
- 5 Exit Audio Setup mode**
Press the [6] ("RTN") button.

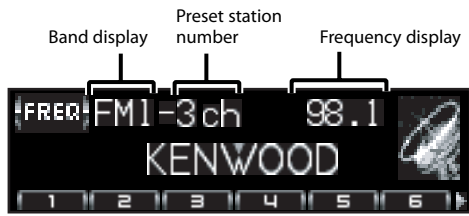
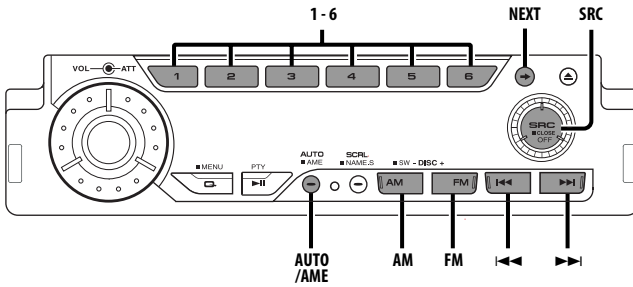
Tuner features



Tuning Mode

Choose the tuning mode.

Press the [AUTO] button.

Each time the button is pressed the Tuning mode switches as shown below.

Tuning mode	Display	Operation
Auto seek	"Auto 1"	Automatic search for a station.
Preset station seek	"Auto 2"	Search in order of the stations in the Preset memory.
Manual	"Manual"	Normal manual tuning control

Tuning

Selecting the station.

1 Select tuner source

Press the [SRC] button.

Select the "TUNER" display.

2 Select the band

Press the [FM] or [AM] button.

Each time the [FM] button is pressed it switches between the FM1, FM2, and FM3 bands.

3 Tune up or down band

Press the [◀◀] or [▶▶] button.

Tuner features

Function of remote

Direct Access Tuning

Entering the frequency and tuning.

1 Select the band

Press the [FM] or [AM] button.

2 Enter Direct Access Tuning mode

Press the [DIRECT] button on the remote.

"- - - -" is displayed.

3 Enter the frequency

Press the number buttons on the remote.

Example:

Desired frequency	Press button
92.1 MHz (FM)	[0], [9], [2], [1]
810 kHz (AM)	[0], [8], [1], [0]

Canceling Direct Access Tuning

Press the [DIRECT] button on the remote.

Station Preset Memory

Putting the station in the memory.

1 Select the band

Press the [FM] or [AM] button.

2 Select the frequency to put in the memory

Press the [◀◀] or [▶▶] button.

3 Select the key function section

Press the [NEXT] button.

Repeatedly press the button until "[1]" — "[6]" are displayed above the [1] — [6] buttons.

Refer to 'Notes on Multi-function Key System' (page 9).

4 Put the frequency in the memory

Press the desired [1] — [6] button for at least 2 seconds.

The preset number display blinks 1 time.

On each band, 1 station can be put in the memory on each [1] — [6] button.

Auto Memory Entry

Putting stations with good reception in the memory automatically.

1 Select the band for Auto Memory Entry

Press the [FM] or [AM] button.

2 Open Auto Memory Entry

Press the [AME] button for at least 2 seconds.

When 6 stations that can be received are put in the memory Auto Memory Entry closes.

Preset Tuning

Calling up the stations in the memory.

1 Select the band

Press the [FM] or [AM] button.

2 Select the key function section

Press the [NEXT] button.

Repeatedly press the button until "[1]" — "[6]" are displayed above the [1] — [6] buttons.

Refer to 'Notes on Multi-function Key System' (page 9).

3 Call up the station

Press the desired [1] — [6] button.

Function of Remote

SNPP (Station Name Preset Play)

Display SNPS and Select the station.

1 Enter SNPP mode

Press the [DNPP] button on the remote.

When "SNPP" is displayed, SNPS or PS displays in the FM1, FM2, FM3 and AM bands in order.



- If the station has no name, the frequency is displayed instead.

Changing the display order

Press the [◀◀] or [▶▶] button.

Changing the displayed band

Press the [FM] or [AM] button.

2 If the station you want is displayed

Press the [OK] button on the remote.

The displayed SNPS station is received.

Canceling the SNPP mode

Press the [DNPP] button on the remote.

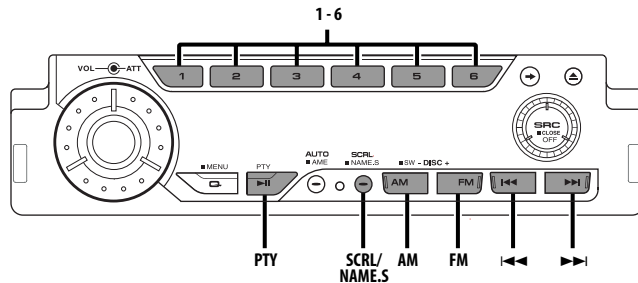

Radio Text Scroll

Scrolling the displayed radio text.

Press the [SCRL] button.

Registration of a station as a PTY

Registering a Program Type for stations with no PTY data.

- 1 Receive the station you want to register**
- 2 Select the Program Type to register**
Refer to 'PTY (Program Type)' (page 35).
- 3 Register the Program Type**
Press the [NAME.S] button for at least 2 seconds.

Confirming the Program Type

Press the [SCRL] button.

The Program Type is displayed for 5 seconds.

- 4 Exit PTY mode**
Press the [PTY] button.

Program Type preset

Putting the Program Type in the Preset button memory and calling it up quickly.

Presetting the Program Type

- 1 Select the Program Type to preset**
Refer to 'PTY (Program Type)' (page 35).
- 2 Preset the Program Type**
Press the desired [1] — [6] button for at least 2 seconds.

Calling up the preset Program Type

- 1 Enter PTY mode**
Refer to 'PTY (Program Type)' (page 35).
- 2 Call up the Program Type**
Press the desired [1] — [6] button.

PTY (Program Type)

Selecting the Program Type and searching for a station.

1 Enter PTY mode

Press the [PTY] button.

"PTY Select" is displayed.



- This function can't be used during a traffic bulletin or AM reception.

2 Select the Program Type

Press the [FM] or [AM] button.

No.	Program Type	Display
1.	Speech	"All Speech"
2.	Music	"All Music"
3.	News	"News"
4.	Information	"Information"
5.	Sports	"Sports"
6.	Talk	"Talk"
7.	Rock	"Rock"
8.	Classic Rock	"Classic Rock"
9.	Adult Hits	"Adult Hits"
10.	Soft Rock	"Soft Rock"
11.	Top 40	"TOP 40"
12.	Country	"Country"
13.	Oldies	"Oldies"
14.	Soft	"Soft"
15.	Nostalgia	"Nostalgia"
16.	Jazz	"Jazz"
17.	Classical	"Classical"
18.	R & B	"Rhythm & Blues"
19.	Soft R & B	"Soft R & B"
20.	Language	"Foreign Language"
21.	Religious Music	"Religious Music"
22.	Religious Talk	"Religious Talk"
23.	Personality	"Personality"
24.	Public	"Public"
25.	College	"College"
26.	Weather	"Weather"



- Speech and Music include the Program type below.
Music: No.7 — 19, 21
Speech: No.3 — 6, 20, 22 — 26
- The Program Type can be put in the [1] — [6] button memory and called up quickly. Refer to the 'Program Type preset' (page 34).

3 Search for the selected Program Type station

Press the [◀◀] or [▶▶] button.

When you want to search for other stations press the [◀◀] or [▶▶] button again.



- When the selected Program Type isn't found, "NO PTY" is displayed. Select another Program Type.

4 Exit PTY mode

Press the [PTY] button.

CD/MP3/WMA/External disc control features

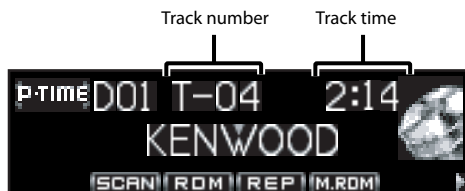
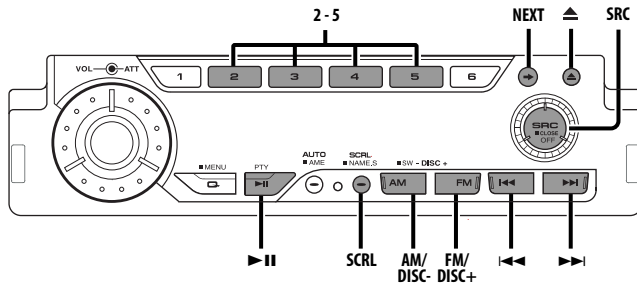

Playing CD & MP3/WMA

When there is no disc inserted

- 1 Open the panel to insert disc
Press the [▲] button.
- 2 Insert a disc.



- When the faceplate has been slid open, it might interfere with the shift lever or something else. If this happens, pay attention to safety and move the shift lever or take an appropriate action, then operate the unit.



- The sound will be temporarily muted while the faceplate is moving.

When a disc is inserted

- Press the [SRC] button.
Select the "Compact Disc" display.

Pause and play

- Press the [▶II] button.
Each time the button is pressed the song pauses or plays.

Eject the disc

- 1 Eject the disc
Press the [▲] button.
- 2 Return the panel to the original position
Press the [▲] button.



- 3 in. (8cm) disc can't be played. Using an adapter and inserting them into this unit can cause damage.



- The MP3/WMA media that this unit can play are CD-ROM, CD-R, and CD-RW.
The medium formats must be ISO 9660 Level 1, Level 2, Joliet, or Romeo. The methods and precautions to be followed for writing MP3/WMA data are covered in 'Notes on playing MP3/WMA' (page 10). Check that section before creating your MP3/WMA media.

Playing External Disc

Playing discs set in the optional accessory disc player connected to this unit.

Press the [SRC] button.

Select the display for the disc player you want.

Display examples:

Display	Disc player
"Compact Disc"	CD player
"CD Changer"	CD changer
"MD Changer"	MD changer

Pause and play

Press the [▶II] button.

Each time the button is pressed it pauses and plays.



- The functions that can be used and the information that can be displayed will differ depending on the external disc players being connected.

Fast Forwarding and Reversing

Fast Forwarding

Hold down on the [▶▶] button.

Release your finger to play the disc at that point.

Reversing

Hold down on the [◀◀] button.

Release your finger to play the disc at that point.

Track/File Search

Searching for a song on the disc or in the MP3/WMA folder.

Press the [◀◀] or [▶▶] button.

Function of disc changer/ MP3/ WMA

Disc Search/Folder Search

Selecting the disc set in the Disc changer or the folder recorded on the MP3/WMA media.

Press the [DISC-] or [DISC+] button.

Function of remote

Direct Track/File Search

Doing Track/File Search by entering the track/file number.

1 Enter the track/file number

Press the number buttons on the remote.

2 Do Track/File Search

Press the [◀◀] or [▶▶] button.

Canceling Direct Track/File Search

Press the [▶II] button.

Function of disc changers with remote

Direct Disc Search

Doing Disc Search by entering the disc number.

1 Enter the disc number

Press the number buttons on the remote.

2 Do Disc Search

Press the [DISC+] or [DISC-] button.

Canceling Direct Disc Search

Press the [▶II] button.

CD/MP3/WMA/External disc control features

Track/File/Disc/Folder Repeat

Replaying the song, disc in the Disc changer or MP3/WMA folder you're listening to.

1 Select the key function section

Press the [NEXT] button.

Repeatedly press the button until "REP" is displayed above the [4] button.

Refer to 'Notes on Multi-function Key System' (page 9).

2 Turn ON/OFF the Repeat Play

Press the [4] ("REP") button.

Each time the button is pressed the Repeat Play switches as shown below.

In CD & External disc source

Repeat play	Display
Track Repeat (In Disc Changer)	"Repeat ON" "Track Repeat ON"
Disc Repeat (In Disc Changer)	"Disc Repeat ON"
OFF	"Repeat OFF"

In MP3/WMA source

Repeat play	Display
File Repeat	"File Repeat ON"
Folder Repeat	"Folder Repeat ON"
OFF	"Repeat OFF"

Scan Play

Playing the first part of each song on the disc or MP3/WMA folder you are listening to and searching for the song you want to listen to.

1 Select the key function section

Press the [NEXT] button.

Repeat to press the button until "SCAN" is displayed above the [2] button.

Refer to 'Notes on Multi-function Key System' (page 9).

2 Start Scan Play

Press the [2] ("SCAN") button.

"Scan ON" is displayed.

3 Release it when the song you want to listen to is played

Press the [2] button.

Random Play

Play all the songs on the disc or MP3/WMA folder in random order.

1 Select the key function section

Press the [NEXT] button.

Repeatedly press the button until "RDM" is displayed above the [3] button.

Refer to 'Notes on Multi-function Key System' (page 9).

2 Turn ON/OFF the Random Play

Press the [3] ("RDM") button.

Each time the button is pressed Random Play turns ON or OFF.

When it's ON, "Random ON" is displayed.



- When the [▶▶] button is pressed, the next song select starts.

Function of disc changer

Magazine Random Play

Play the songs on all the discs in the disc changer in random order.

1 Select the key function section

Press the [NEXT] button.

Repeatedly press the button until "M.RDM" is displayed above the [5] button.

Refer to 'Notes on Multi-function Key System' (page 9).

2 Turning ON/OFF the Magazine Random Play

Press the [5] ("M.RDM") button.

Each time the button is pressed the Magazine Random Play turns ON or OFF.

When it's ON, "M.Random ON" is displayed.



- When the [▶▶] button is pressed, the next song select starts.

Folder Select

Quickly selecting the folder you want to listen to.

1 Select the key function section

Press the [NEXT] button.

Repeatedly press the button until "FSEL" is displayed above the [5] button.

Refer to 'Notes on Multi-function Key System' (page 9).

2 Enter Folder Select mode

Press the [5] ("FSEL") button.

"FOLDER SELECT" is displayed.

During Select mode the folder information is displayed as shown below.

Folder name display

Displays the current folder name.



Folder number display

Displays the number in the folder belonging to the currently selected folder.

3 Select the folder level

Press the [FM] or [AM] button.

With the [FM] button you move 1 level down and with the [AM] button 1 level up.

Selecting a folder in the same level

Press the [◀◀] or [▶▶] button.

With the [◀◀] button you move to the previous folder, and with the [▶▶] button to the next folder.

Returning to the top level

Press the [4] ("HOME") button.

Scrolling the folder name display

Press the [SCRL] button.

4 Decide the folder to play

Press the [2] ("OK") button.

The Folder Select mode releases, and the MP3/WMA in the folder being displayed is played.



- The methods for moving to other folders in the folder select mode are different from those in the folder search mode.

See 'Notes on playing MP3/WMA' (page 10) for details.

Canceling the Folder Select mode

Press the [3] ("EXIT") button.

Text/Title Scroll

Scrolling the displayed CD text or MD title.

Press the [SCRL] button.

Function of disc changers with remote

DNPP (Disc Name Preset Play)

Selecting the CD displayed in the DNPS of the CDs set in the Disc changer.

1 Enter DNPP mode

Press the [DNPP] button on the remote.

When "DNPP" is displayed the DNPS display in order.

Forward / Reverse display

Press the [DISC-] or [DISC+] button.

2 When the disc you want is displayed

Press the [OK] button on the remote.

The disc being displayed is played.

Canceling the DNPP mode

Press the [DNPP] button on the remote.

SIRIUS tuner control features

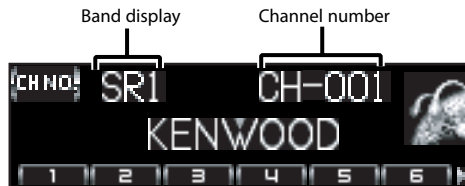
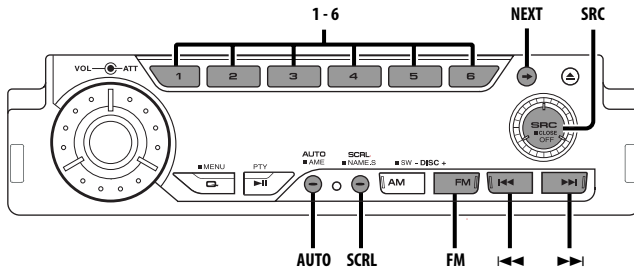

Select SIRIUS Satellite Radio Mode

Selecting the SIRIUS Satellite Radio Tuner (optional accessory) connected to this unit.

Selecting SIRIUS Mode

Press the [SRC] button.

Select the "SIRIUS" display.



- You need to subscribe to SIRIUS to receive the service by SIRIUS Satellite Radio. Consult SIRIUS if "CALL 888-539 SIRIUS TO SUBSCRIBE" appears.
- It may take a little time to start receiving after you selected the SIRIUS source.
- If the signal receiving fails, "Acquiring Signal" appears.

Switching Seek Mode

Sets the seeking mode.

Press the [AUTO] button.

Each time the button is pressed the Seek mode switches as shown below.

Display	Operation
"Channel"	Normal manual seeking control.
"Preset"	Search in order of the channels in the Preset memory.

Select the channel

Selecting the channel.

Press the [◀◀] or [▶▶] button.

Channel Search

Selecting the channel and category you want to receive.

1 Select the key function section

Press the [NEXT] button.

Repeatedly press the button until "CH+"/ "CH-"/ "CS+"/ "CS-" is displayed above the [2] — [5] button.

2 Select the item for adjustment

Press the desired [2] — [5] button.

Each time the button is pressed the items that can be adjusted switch as shown below.

Adjustment Item	Button	Display
Search down in category	[2]	"CS—"
Search up in category	[3]	"CS+"
Search down for channel in selected category	[4]	"CH—"
Search up for channel in selected category	[5]	"CH+"



- You cannot operate this unit until all the Category information is acquired.

Function of remote

Direct Access Tuning

Entering the channel and tuning.

1 Enter Direct Access Tuning mode

Press the [DIRECT] button on the remote.

2 Enter the channel

Press the number buttons.

3 Do Channel Search

Press the [◀◀] or [▶▶] button.

Canceling Direct Access Tuning

Press the [DIRECT] button on the remote.



- If you make no button operation for 10 seconds, the Direct Access Tuning mode is automatically canceled.
- You can set up to Channel number 223.
- If there is no signal in the input Channel, "NO CHANNEL" appears.
- If you cannot receive any signal in the input Channel due to a bad condition on radio wave or another problem, "Acquiring Signal" appears.

Selecting the Preset Band

Press the [FM] button.

Each time the button is pressed the preset band switches between the SR1, SR2, SR3 and SR4.

Channel Preset Memory

Putting the channel in the memory.

1 Select the preset band

Press the [FM] button.

2 Select the channel to put in the memory

Press the [◀◀] or [▶▶] button.

3 Select the key function section

Press the [NEXT] button.

Repeatedly press the button until "[1]" — "[6]" are displayed above the [1] — [6] buttons.

Refer to 'Notes on Multi-function Key System' (page 9).

4 Put the channel in the memory

Press the desired [1] — [6] button for at least 2 seconds.

The preset number display blinks 1 time.

On each band, 1 channel can be put in the memory on each [1] — [6] button.



- Only the channel number is stored. Category information is not stored.

Preset Tuning

Calling up the channels in the memory.

1 Select the preset band

Press the [FM] button.

2 Select the key function section

Press the [NEXT] button.

Repeatedly press the button until "[1]" — "[6]" are displayed above the [1] — [6] buttons.

Refer to 'Notes on Multi-function Key System' (page 9).

3 Call up the channel

Press the desired [1] — [6] button.

SIRIUS tuner control features

Channel Scan

Every receivable Channel is checked for 10 seconds.

1 Start Channel Scan

Press the [AUTO] button for at least 1 second.

The channel number display blinks.

2 Release it when the song you want to listen to is received

Press the [AUTO] button for at 1 second.

Text Scroll for SIRIUS tuner source

Scrolls the displayed channel name and other items.

Press the [SCRL] button.

HD Radio control features

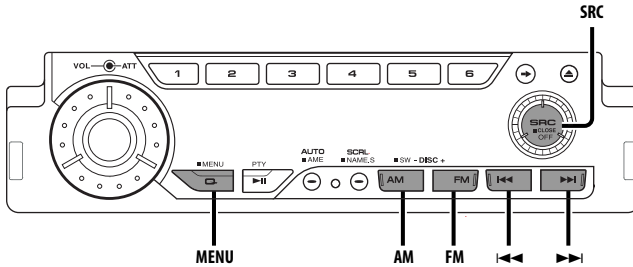

Tuning

Selecting the station.

1 Select HD Radio source

Press the [SRC] button.

Select the "HD RADIO" display.

2 Select the HF band

Press the [FM] button.

Each time the [FM] button is pressed it switches between the HF1, HF2, and HF3 bands.

Select the HA band

Press the [AM] button.

3 Tune up or down band

Press the [◀◀] or [▶▶] button.



- When you connect an HD Radio, Tuner features of the unit are disabled and switched to HD Radio tuner features. A portion of the setting methods including the Tuning Mode will change.
- With the HD Radio tuner, you can use the similar functions to 'Station Preset Memory' and 'Preset Tuning' of Tuner features. Refer to Tuner features for how to use the functions.

- The RDS function will no longer be possible.
- The HD Radio cannot be selected as a dual zone source.

Auto Memory Entry

Putting a station with good reception in the memory automatically.

1 Select the band for Auto Memory Entry

Press the [FM] or [AM] button.

2 Enter Menu mode

Press the [MENU] button for at least 1 second.

"MENU" is displayed.

3 Select the Auto Memory Entry mode

Press the [FM] or [AM] button.

Select the "Auto Memory" display.

4 Open Auto Memory Entry

Press the [◀◀] or [▶▶] button for at least 2 seconds.

When 6 stations that can be received are put in the memory Auto Memory Entry closes.

5 Exit Menu mode

Press the [MENU] button.



- The receiving method can be switched with the setting of 'Receive mode Setting' (page 50).

Menu system

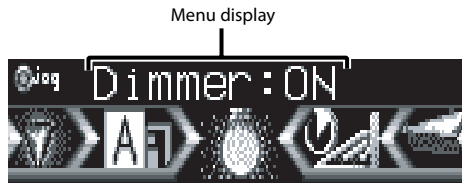
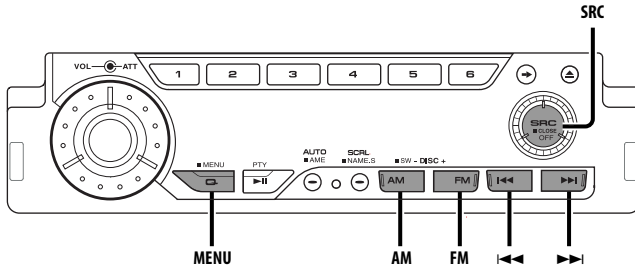

Menu System

Setting during operation beep sound etc. functions.

The Menu system basic operation method is explained here. The reference for the Menu items and their setting content is after this operation explanation.

1 Enter Menu mode

Press the [MENU] button for at least 1 second.
"MENU" is displayed.

2 Select the menu item

Press the [FM] or [AM] button.
Example: When you want to set the beep sound select the "Beep" display.

3 Set the menu item

Press the [◀◀] or [▶▶] button.
Example: When "Beep" is selected, each time the button is pressed it switches "Beep: ON" or "Beep: OFF". Select 1 of them as the setting.

You can continue by returning to step 2 and setting other items.

4 Exit Menu mode

Press the [MENU] button.



- When other items that are applicable to the basic operation method above are displayed afterwards their setting content chart is entered. (Normally the uppermost setting in the chart is the original setting.) Also, the explanation for items that aren't applicable ('Manual Clock Adjustment' etc.) are entered step by step.

Menu system

In Standby mode

Security Code

Because authorization by the Security Code is required when it's removed from the vehicle, personalizing this unit is by using the Security Code is a help in preventing theft.



- When the Security Code function is activated, the code can't be changed and the function can't be released. Note, the Security Code can be set as the 4 digit number of your choice.

1 Enter Standby

Press the [SRC] button.

Select the "STANDBY" display.

2 Enter Menu mode

Press the [MENU] button for at least 1 second.

When "MENU" is displayed, "Security" is displayed.

3 Enter Security Code mode

Press the [◀◀] or [▶▶] button for at least 1 second.

When "ENTER" is displayed, "CODE" is displayed.

4 Select the digits to enter

Press the [◀◀] or [▶▶] button.

5 Select the Security Code numbers

Press the [FM] or [AM] button.

6 Repeat steps 4 and 5, and complete the Security Code.

7 Confirm the Security Code

Press the [▶▶] button for at least 3 seconds.

When "RE-ENTER" is displayed, "CODE" is displayed.

8 Do the step 4 through 7 operation, and reenter the Security Code.

"APPROVED" is displayed.

The Security Code function activates.



- When the wrong Code is entered in steps 4 through 6, repeat from step 4.

Press the Reset button and when it's removed from the battery power source

1 Turn the power ON.

2 Do the step 4 through 7 operation, and enter the Security Code.

"APPROVED" is displayed.

The unit can be used.

Touch Sensor Tone

Setting the operation check sound (beep sound) ON/OFF.

Display	Setting
"Beep: ON"	Beep is heard.
"Beep: OFF"	Beep canceled.

Manual Clock Adjustment



- This adjustment can be done when the 'Synchronize Clock' (page 47) is set as OFF.

1 Select Clock Adjustment mode

Press the [FM] or [AM] button.

Select the "Clock Adjust" display.

2 Enter Clock Adjust mode

Press the [◀◀] or [▶▶] button for at least 1 second.

The clock display blinks.

3 Adjust the hours

Press the [FM] or [AM] button.

Adjust the minutes

Press the [◀◀] or [▶▶] button.

4 Exit Clock adjustment mode

Press the [MENU] button.

Date Adjustment

1 Select Date Adjust mode

Press the [FM] or [AM] button.

Select the "Date Adjust" display.

2 Enter Date Adjust mode

Press the [◀◀] or [▶▶] button for at least 1 second.

The date display blinks.

3 Selecting the item (day, month, or year) to adjust

Press the [◀◀] or [▶▶] button.

The items that are blinking are items that can be adjusted.

4 Adjust each item

Press the [FM] or [AM] button.

5 Repeat step 3 and 4 operation and adjust the date.

6 Exit Date adjustment mode

Press the [MENU] button.

Date Mode

Setting the date format.

1 Select Date Mode

Press the [FM] or [AM] button.

Select the "Date Mode" display.

2 Select the date format

Press the [◀◀] or [▶▶] button.

Synchronize Clock

Synchronizing the RDS station time data and this unit's clock.

Display	Setting
"SYNC: OFF"	Adjust the time manually.
"SYNC: ON"	Synchronizes the time.



- It takes 3 to 4 minutes to synchronize the clock.

DSI (Disabled System Indicator)

A red indicator will blink on the unit after the faceplate is removed, warning potential thieves.

Display	Setting
"DSI: ON"	LED flashes.
"DSI: OFF"	LED OFF.

Selectable Illumination

Selecting the button illumination color as green or red.

Display	Setting
"Button: Red"	The illumination color is red.
"Button: Green"	The illumination color is green.

Triangle indicator setting

Sets the blinking mode during triangle indicator system adjustment (such as audio control, audio setup, multi-key system setup).

Display	Setting
"TRIAGL Blink:ON"	The Triangle indicator blinks.
"TRIAGL Blink:OFF"	The Triangle indicator does not blink.

Font Type Select

Selecting the display font.

1 Select Font Type Select Mode

Press the [FM] or [AM] button.

Select the "Font Select" display.

2 Select the font

Press the [◀◀] or [▶▶] button.

Menu system

Dimmer

Dimming this unit's display automatically when the vehicle light switch is turned ON.

Display	Setting
"Dimmer: ON"	The display dims.
"Dimmer: OFF"	The display doesn't dim.

OFF Wait Time Setting

Setting the time until the faceplate hide operation starts after the power is turned OFF. The faceplate can be removed only during the set time period.

Display and Setting
"Off Wait : 0sec"
:
"Off Wait : 3sec" (Original setting)
:
"Off Wait : 25sec"

In Standby mode

Eject angle setting

This function sets the opening and closing operation of a panel when a disc is inserted and when it is ejected.

Display	Setting
"Eject ANG: Slope"	Opens and closes the panel while maintaining the angle of the control panel to the set angle.
"Eject ANG: Level"	Opens and closes the panel after setting the angle of the control panel to the horizontal position.

In Standby mode

Panel action setting

Sets the panel movement when the panel action (back/forward movement) is set to its most end position.

Display	Setting
"Panel Control:1"	No angle can be adjusted if the panel position has been set to its most end position. Also, if you have set the angle below the horizontal position, the angle is set to horizontal when you set the panel to its most end position.
"Panel Control:2"	The angle can be adjusted regardless of the panel position.

Function of the KDC-X879

System Q Setting

Setting whether the display indicates the System Q factors (Bass center frequency, Bass Q factor, Bass extend, Middle center frequency, Middle Q factor, and Treble center frequency) in Audio control.

Display	Setting
"System Q: ON"	The System Q factors are displayed.
"System Q: OFF"	The System Q factors aren't displayed.

Function of the KDC-X979

Audio Setup

Switches between the Easy mode and PRO mode (for detailed setup) during Audio setup.

Display	Setting
"Audio Setup:Easy"	Selects the quick Audio setup.
"Audio Setup:PRO"	Selects the detailed Audio setup.



- Refer to 'Audio Setup (Easy)' (page 28) and 'Audio Setup (PRO)' (page 28).
"Audio Setup:Easy" : [CABIN] [SP-SEL] [SP-LEV] [CALL]
"Audio Setup:PRO" : [X'over] [DTA] [EQ] [SP-LEV] [MEMORY] [CALL]

In Standby mode

Built-in Amp Mute Setting

Toggles ON or OFF the mute control on the built-in amplifier.

Turning ON this control enhances the preout quality.

Display	Setting
"AMP Mute: OFF"	The built-in amplifier activates.
"AMP Mute: ON"	The built-in amplifier deactivates.

Function of the KDC-X979/KDC-X879

B.M.S. (Bass Management System)

Adjust the bass boost level of the external amplifier using the main unit.

Display	Setting
"AMP Bass: Flat"	Bass boost level is flat.
"AMP Bass: +6"	Bass boost level is low (+6dB).
"AMP Bass: +12"	Bass boost level is mid (+12dB).
"AMP Bass: +18"	Bass boost level is high (+18dB).



- Refer to the catalog or instruction manual for power amplifiers that can be controlled from this unit.
- For amplifiers there are the model that can be set from Flat to +18 dB, and the model that can be set from Flat to +12 dB.

When an amplifier that can only be set to +12 is connected to the unit, "AMP Bass: +18" won't work correctly even if it's selected.

Function of the KDC-X979/KDC-X879

B.M.S. Frequency Offset

Setting the central frequency boosted by B.M.S.

Display	Setting
"AMP FRQ: Normal"	Boost with the normal central frequency.
"AMP FRQ: Low"	Drop the normal central frequency 20%.

Traffic Information

Switching to traffic information automatically when a traffic bulletin starts even when you aren't listening to the radio.

Display	Setting
"TI: ON"	The Traffic Information function is ON.
"TI: OFF"	The Traffic Information function is OFF.

When a traffic bulletin starts, "Traffic Info"/ "Announcement" is displayed it and it switches to traffic information.



- During reception of an AM station when the Traffic Information function is turned ON it switches to an FM station.
- During reception of traffic information the adjusted volume is automatically remembered, and the next time it switches to traffic information it's automatically the remembered volume.

Receiving other traffic information stations (In tuner source)

Press the [◀◀] or [▶▶] button.



- Traffic information station switching can be done when listening to the radio.

In FM reception

CRSC (Clean Reception System Circuit)

Temporarily have reception switched from stereo to mono to reduce multi-path noise when listening to the FM station.

Display	Setting
"CRSC: ON"	The CRSC is ON.
"CRSC: OFF"	The CRSC is OFF.



- Strong electrical fields (such as from power lines) may cause unstable sound quality when CRSC is turned ON. In such a situation, turn it OFF.

Menu system

In HD Radio mode

Tuning Mode

Sets the tuning mode.

Tuning mode	Display	Operation
Auto seek	"Seek mode: Auto 1"	Automatic search for a station.
Preset station seek	"Seek mode: Auto 2"	Search in order of the stations in the Preset memory.
Manual	"Seek mode: Manual"	Normal manual tuning control.

In HD Radio mode

Receive mode Setting

Sets the receive mode.

1 Select the Receive mode

Press the [FM] or [AM] button.

Select the "Receive Mode" display.

2 Enter Receive mode

Press the [◀◀] or [▶▶] button for at least 1 second.

3 Set the Receive mode

Press the [FM] or [AM] button.

Each time the button is pressed the Receive mode switches as shown below.

Receive mode	Display	Operation
Auto mode	"Auto"	Analog broadcasts and digital broadcasts will be switched automatically. When both are being transmitted, the digital broadcast will have priority.
Digital	"Digital"	Digital broadcasts only.
Analog	"Analog"	Analog broadcasts only.

4 Exit Receive mode

Press the [MENU] button.



- Even if the "Auto" setting, an analog broadcast will be received during the reception of a ball game mode (non-delayed broadcast program).

In HD Radio mode

Auto Memory Entry

For the operation method refer to 'Auto Memory Entry' (page 44).

Text Scroll

Setting the displayed text scroll.

Display	Setting
"Scroll: Auto"	Repeats scroll.
"Scroll: Manual"	Scrolls when the display changes.



- The text scrolled is shown below.
 - CD text
 - Folder name/ File name/ Song title/ Artist name/ Album name
 - MD title
 - Radio text
 - Text for the SIRIUS tuner source, HD Radio source, including Channel name, etc.

Built-in Auxiliary input Setting

Set the Built-in Auxiliary Input function.

Display	Setting
"Builtin AUX: OFF"	When selecting the source there's no Auxiliary Input.
"Builtin AUX: ON"	When selecting the source there's Auxiliary Input.

In SIRIUS tuner source

SIRIUS ID (ESN) display

Displaying the SIRIUS ID (Electronic Serial Number) display.

Display
"ESN: *****"



- Serial & SIRIUS ID (ESN)
It is especially important to retain the unit serial number and the electronic SIRIUS Identification number for service activation and potential future service changes.

In Standby mode

CD Read Setting

When there is a problem on playing a CD with special format, this setting play the CD by force.

Display	Setting
"CD READ: 1"	Play CD and MP3/WMA.
"CD READ: 2"	Play CD by force.



- Setting "CD READ: 2" cannot play MP3/WMA. Some music CDs may not be played back even in the "CD READ: 2" mode.

Function of the KDC-X979

In Standby mode

Picture downloading

Downloading movies and wallpapers.
Downloaded pictures can be used for the display of this unit.

1 Inset a CD-R/CD-RW.

Insert a CD-R/CD-RW containing files to be downloaded into this unit.
Refer to 'Playing CD & MP3/WMA' (page 36) for details.
Our URL <http://www.kenwood.net-disp.com> describes how to make CD-R/CD-RW.

2 Enter Standby

Press the [SRC] button.
Select the "STANDBY" display.

3 Enter Menu mode

Press the [MENU] button for at least 1 second.
"MENU" is displayed.

4 Select the downloading mode

Press the [FM] or [AM] button.
Select the "DISP Data DL" display.

5 Enter the downloading mode

Press the [◀◀] or [▶▶] button.
"File Check!!" is displayed.

6 Select files to be downloaded

Press the [FM] or [AM] button.

7 Start downloading

Press the [◀◀] or [▶▶] button for at least 2 seconds.

"Downloading" is displayed.
When the downloading finishes, "Finished Download" is displayed.



- Picture download may take as long as 10 minutes.

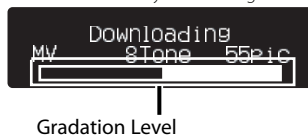

Canceling Downloading

Press the [MENU] button.

8 Exit the downloading mode

Press the [MENU] button.



- The number of files that can be downloaded.
 - Downloaded movie: 1 file
 - Wallpaper: 1 file
- When a new movie is downloaded, it is overwritten to the currently downloaded movie.
Also, when a new wallpaper is downloaded, it is overwritten to the currently downloaded wallpaper.
There is no way to delete the downloaded pictures.
- The downloaded pictures can be used for display.
'Graphic part/ Spectrum Analyzer Display Switching' (page 18)
'Wallpaper selecting' (page 18)
- When you can't download the pictures to this unit, there may be a problem with the CD-R/CD-RW write method.
Refer to the URL <http://www.kenwood.net-disp.com>, and rewrite the CD-R/CD-RW.

Menu system

Function of the KDC-X979/KDC-X879
When LX AMP unit connecting

AMP Control

You can control the LX AMP connected to the unit.

1 Select AMP Control mode

Press the [FM] or [AM] button.

Select the "AMP Control" display.

2 Enter AMP Control mode

Press the [◀◀] or [▶▶] button for at least 1 second.

3 Select the AMP Control item for adjustment

Press the [FM] or [AM] button.



- For the details of the AMP Control item, see the Instruction manual attached to the LX AMP.

4 Adjust the AMP Control item

Press the [◀◀] or [▶▶] button.

5 Exit AMP Control mode

Press the [MENU] button.



- You cannot use the LX AMP operation during standby mode.

Rotary volume operation select

Various items can be set using the rotary volume knob.

Display	Setting
"Rotary SEL:ON"	The rotary volume knob can be used for item setup.
"Rotary SEL:OFF"	The rotary volume knob cannot be used for item setup.



- To use the rotary volume knob for item setup, select "Rotary SEL: ON" and press the [1] button in each setup mode.

Basic Operations of remote

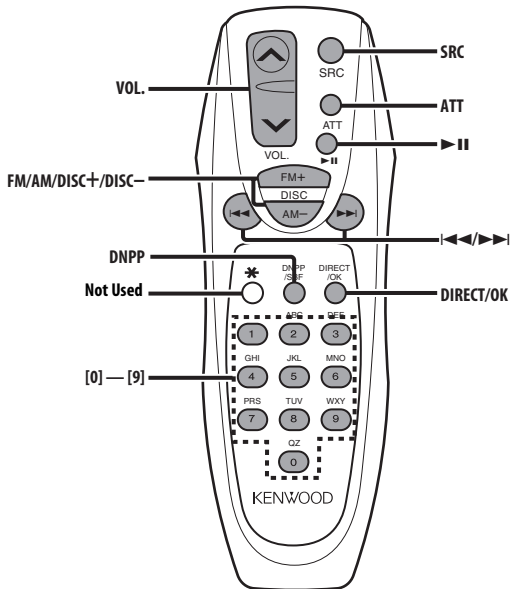

Loading and Replacing the battery

Use two "AA"-size batteries.

Slide the cover while pressing downwards to remove it as illustrated.

Insert the batteries with the + and – poles aligned properly, following the illustration inside the case.

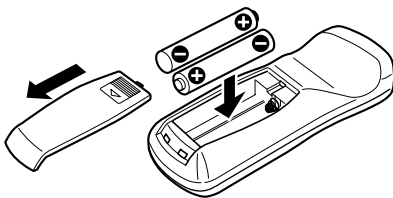

▲WARNING

- Store unused batteries out of the reach of children. Contact a doctor immediately if the battery is accidentally swallowed.



- Do not set the remote on hot places such as above the dashboard.

Basic operations

[VOL.] buttons

Adjusting the volume.

[SRC] button

Each time the button is pressed the source switches.

For the source switching order refer to 'Selecting the Source' (page 14).

[ATT] button

Turning the volume down quickly.

When it is pressed again it returns to the previous level.

Basic Operations of remote

In Tuner source

[FM]/ [AM] buttons

Select the band.

Each time the [FM] button is pressed it switches between the FM1, FM2, and FM3 bands.

[◀◀]/ [▶▶] buttons

Tune up or down band.

[0] — [9] buttons

Press buttons [1] — [6] to recall preset stations.

[DIRECT]/ [OK] button

Enters and cancels the 'Direct Access Tuning' (page 32) mode.

[▶II] button

Enters and cancels the 'PTY (Program Type)' (page 35) mode.

[DNPP] button

Enters and cancels the 'SNPP (Station Name Preset Play)' (page 33) mode.

In Disc source

[◀◀]/ [▶▶] buttons

Doing track/file forward and backward.

[DISC+]/ [DISC-] buttons

Doing disc/folder forward and backward.

[▶II] button

Each time the button is pressed the song pauses and plays.

[DNPP] button

Enters and cancels the 'DNPP (Disc Name Preset Play)' (page 39) mode.

[0] — [9] buttons

When in 'Direct Track/File Search' (page 37) and 'Direct Disc Search' (page 37), enter the track/file/disc number.

In SIRIUS tuner source

[FM] buttons

Select the preset band.

[◀◀]/ [▶▶] buttons

Search up or down channel.

[0] — [9] buttons

Press buttons [1] — [6] to recall preset channels.

[DIRECT]/ [OK] button

Enters and cancels the 'Direct Access Tuning' (page 41) mode.

In HD Radio source

[FM] button

Select the HF band.

Each time the [FM] button is pressed it switches between the HF1, HF2, and HF3 bands.

[AM] button

Select the HA band.

[◀◀]/ [▶▶] buttons

Tune up or down band.

[0] — [9] buttons

Press buttons [1] — [6] to recall preset stations.

Accessories/ Installation Procedure

Accessories

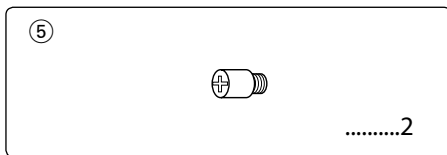
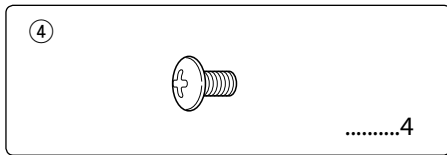
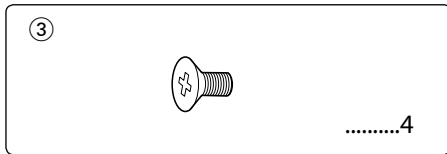
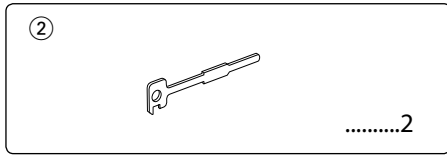
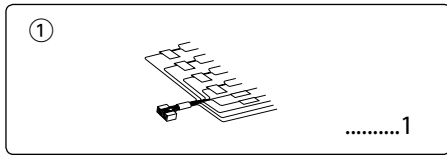

Installation Procedure

1. To prevent a short circuit, remove the key from the ignition and disconnect the ⊖ battery.
2. Make the proper input and output wire connections for each unit.
3. Connect the speaker wires of the wiring harness.
4. Connect the wiring harness wires in the following order: ground, battery, ignition.
5. Connect the wiring harness connector to the unit.
6. Install the unit in your car.
7. Reconnect the ⊖ battery.
8. Turn the vehicle's ignition key on and open the panel.
9. Press the [5] button and the reset button.

▲WARNING

If you connect the ignition wire (red) and the battery wire (yellow) to the car chassis (ground), you may cause a short circuit, that in turn may start a fire. Always connect those wires to the power source running through the fuse box.



- If your car's ignition does not have an ACC position, connect the ignition wires to a power source that can be turned on and off with the ignition key. If you connect the ignition wire to a power source with a constant voltage supply, as with battery wires, the battery may die.
- If the console has a lid, make sure to install the unit so that the faceplate will not hit the lid when closing and opening.
- If the fuse blows, first make sure the wires aren't touching to cause a short circuit, then replace the old fuse with one with the same rating.
- Insulate unconnected wires with vinyl tape or other similar material. To prevent a short circuit, do not remove the caps on the ends of the unconnected wires or the terminals.
- Connect the speaker wires correctly to the terminals to which they correspond. The unit may be damaged or fail to work if you share the ⊖ wires or ground them to any metal part in the car.
- When only two speakers are being connected to the system, connect the connectors either to both the front output terminals or to both the rear output terminals (do not mix front and rear). For example, if you connect the ⊕ connector of the left speaker to a front output terminal, do not connect the ⊖ connector to a rear output terminal
- After the unit is installed, check whether the brake lamps, blinkers, wipers, etc. on the car are working properly.
- Mount the unit so that the mounting angle is 30° or less.

Connecting Wires to Terminals

	A	B
KDC-X979	Subwoofer output (Black)	Center output (Black)
KDC-MP925	Subwoofer right output (Red)	Subwoofer left output (White)
KDC-X879	Subwoofer right output (Red)	Subwoofer left output (White)

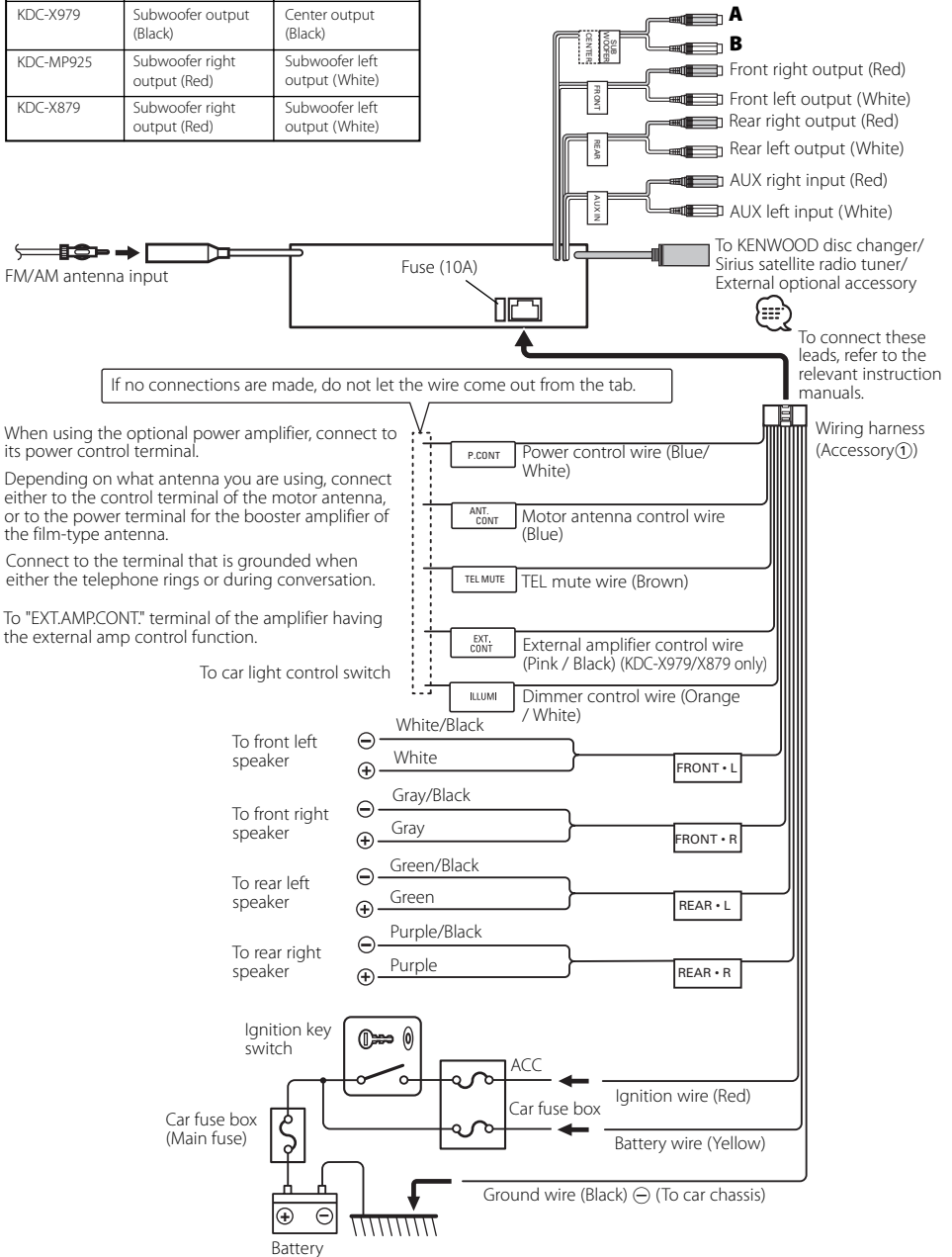

Installation

non-Japanese cars

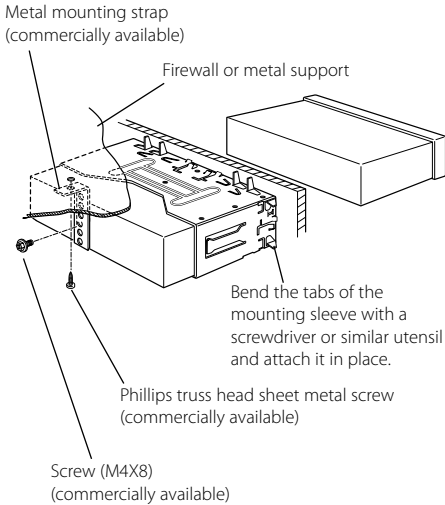

- Make sure that the unit is installed securely in place. If the unit is unstable, it may malfunction (for example, the sound may skip).

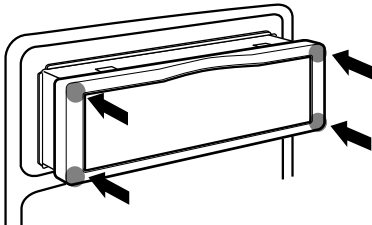

- To attach this unit, make sure the front of the control panel faces you and fit it into the mounting sleeve by pressing the four corners of the hard rubber frame at the same time. Do not apply strong pressure to other sections than the corners; otherwise troubles such as the impossibility of opening or closing the panel may result.
- The hollow at the center of the rubber frame is designed to make it easier to remove discs. If you do not want the hollow to be visible, mount the rubber frame in the opposite direction (with the flat side at the top instead of the bottom).

Japanese cars

- 1 Refer to the section 'Removing the hard rubber frame' (page 59) and then remove the hard rubber frame.
- 2 Align the holes in the unit (two locations on each side) with the vehicle mounting bracket and secure the unit with the accessory screws.

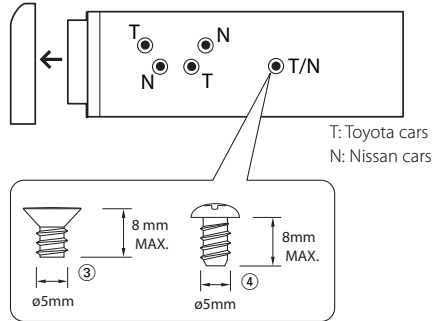

Accessory ③...for Nissan car
Accessory ④...for Toyota car



- During installation, do not use any screws except for those provided. The use of different screws might result in damage to the main unit.
- Damage may occur if a screwdriver or similar tool is used with excessive force during the installations.

Installation

Locking the Backpanel to the unit

If you want to fasten the faceplate to the main unit so that it does not fall off.

- 1 Refer to the Removing the Backpanel function of the section on 'Theft Deterrent Panel' (page 21) and remove the Backpanel.
- 2 Insert the panel lock screws into the holes at the sides of the panel.

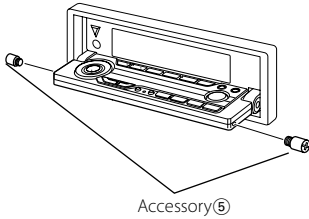

- 3 Reattach the Backpanel.



- Never insert the panel lock screws in any other screw holes than the one specified. If you insert them in another hole, it will contract and may cause damage to the mechanical parts inside the unit.

Removing the Unit

Removing the hard rubber frame

- 1 Engage the catch pins on the removal tool and remove the two locks on the upper level. Upper the frame and pull it forward as shown in the figure.

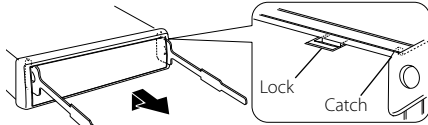

Accessory②
Removal tool

- 2 When the upper level is removed, remove the lower two locations.

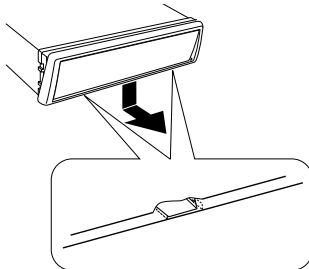

- The frame can be removed from the bottom side in the same manner.

Removing the Unit

- 1 Refer to the section 'Removing the hard rubber frame' (page 59) and then remove the hard rubber frame.
- 2 Remove the screw (M4 × 8) on the back panel.
- 3 Insert the two removal tools deeply into the slots on each side, as shown.

Screw (M4X8)
(commercially available)

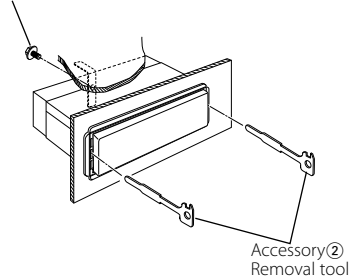

- 4 Lower the removal tool toward the bottom, and pull out the unit halfway while pressing towards the inside.

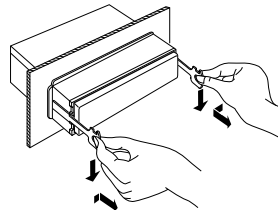

- Be careful to avoid injury from the catch pins on the removal tool.

- 5 Pull the unit all the way out with your hands, being careful not to drop it.

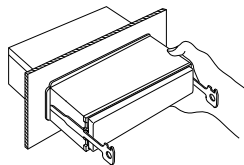

Troubleshooting Guide

What might seem to be a malfunction in your unit may just be the result of slight misoperation or miswiring. Before calling service, first check the following table for possible problems.

General

? The power does not turn ON.

- ✓ The fuse has blown.
 - ☞ After checking for short circuits in the wires, replace the fuse with one with the same rating.
- ✓ Speaker cable touches on chassis etc.
 - ☞ Wire or insulate the speaker cable properly and press the reset button.
- ✓ The Demonstration mode has been selected.
 - ☞ Hold down button [5] and press the Reset button to release the Demonstration mode.

? There's a source you can't switch.

- ✓ There's no media inserted.
 - ☞ Set the media you want to listen to. If there's no media in this unit, you can't switch to each source.
- ✓ The Disc changer isn't connected.
 - ☞ Connect the Disc changer. If the Disc changer isn't connected to its input terminal, You can't switch to an external disc source.

? The memory is erased when the ignition is turned OFF.

- ✓ The ignition and battery wire are incorrectly connected.
 - ☞ Connect the wire correctly, referring to the section on 'Connecting Wires to Terminals'.

? There's no loudness effect.

- ✓ The 'System Q' (KDC-MP925/X879) (page 24)/ 'Audio control' (KDC-X979) (page 26) is set to SRS WOW.
 - ☞ Turn it to the other items.

? The TEL mute function does not work.

- ✓ The TEL mute wire is not connected properly.
 - ☞ Connect the wire correctly, referring to the section on 'Connecting Wires to Terminals'.

? The TEL mute function turns ON even though the TEL mute wire is not connected.

- ✓ The TEL mute wire is touching a metal part of the car.
 - ☞ Pull the TEL mute wire away from the metal part of the car.

? Even if Loudness is turned ON, high-pitched tone isn't compensated for.

- ✓ Tuner source is selected.
 - ☞ High-pitched tone isn't compensated for when in Tuner source.
- ✓ The 'System Q' (KDC-MP925/X879) (page 24) is set to SRS WOW.
 - ☞ Turn it to the other items.

? The Bass center frequency, Bass quality factor, Bass extend, Middle center frequency, Middle quality factor, and Treble center frequency can't be adjusted.

- ✓ The 'System Q Setting' (page 48) is set OFF.
 - ☞ Set it ON.

? No sound can be heard, or the volume is low.

- ✓ The fader or balance settings are set all the way to one side.
 - ☞ Center the fader and balance settings.
- ✓ The input/output wires or wiring harness are connected incorrectly.
 - ☞ Reconnect the input/output wires or the wiring harness correctly. See the section on 'Connecting Wires to Terminals'.
- ✓ The values of Volume offset are low.
 - ☞ Turn up the Volume offset, referring to the section on 'Audio Control' (KDC-MP925/X879) (page 22)/ 'Audio control' (KDC-X979) (page 26).
- ✓ The 'Built-in Amp Mute Setting' (page 49) is ON.
 - ☞ Turn it OFF.
- ✓ If the PLLI is selected by 'Audio Setup (Easy mode)' (KDC-X979) (page 28) and if the Front speaker is set to "16 — 7*10" and the Center speaker is set to "16 over," the subwoofer does not sound.
 - ☞ ---

? The sound quality is poor or distorted.

- ✓ One of the speaker wires is being pinched by a screw in the car.
 - ☞ Check the speaker wiring.
- ✓ The speakers are not wired correctly.
 - ☞ Reconnect the speaker wires so that each output terminal is connected to a different speaker.

? Subwoofer Output, Subwoofer Low Pass Filter and Subwoofer setting can't be done.

- ✓ The 'Dual Zone System' (page 25) is ON.
 - ☞ Turn it OFF.

? The Touch Sensor Tone doesn't sound.

- ✓ The preout jack is being used.
 - ☞ The Touch Sensor Tone can't be output from the preout jack.

? **Even though Synchronize Clock is ON, the clock can't be adjusted.**

- ✓ The received RDS station isn't sending time data.
E38 Receive another RDS station.

? **The Dimmer function doesn't work.**

- ✓ The Dimmer wire isn't connected correctly.
E38 Check the Dimmer wire connection.

? **The panel is not hidden even when the power is turned off.**

- ✓ The protection function for preventing fingers or other things from getting caught in between the panel and this unit has been activated.
E38 Turn off the power again.

? **There are no audio control effects.**

- ✓ FOCUS/ SRS 3D item on 'Audio control' (KDC-X979) (page 26) and SRS WOW item on 'System Q' (KDC-MP925/X879) (page 24) have no effect in rear output.
E38 ---

? **The Control Panel moves although you do not desire.**

- ✓ The Demonstration mode has been selected.
E38 Hold down button [5] and press the Reset button to release the Demonstration mode.

? **Some speakers may not sound even if you control the "T-TONE".**

- ✓ You have selected "None" by Speaker Select control.
E38 The speaker does not sound if it has been set to "None" by Speaker Select control.
- ✓ ---
E38 The subwoofer does not sound.

Tuner source

? **Radio reception is poor.**

- ✓ The car antenna is not extended.
E38 Pull the antenna out all the way.
- ✓ The antenna control wire is not connected.
E38 Connect the wire correctly, referring to the section on 'Connecting Wires to Terminals'.

? **The desired frequency can't be entered with the Direct Access Tuning.**

- ✓ A station that can't be received is being entered.
E38 Enter a station that can be received.
- ✓ You're trying to enter a frequency with a 0.01 MHz unit.
E38 What can be designated in the FM band is to 0.1 MHz.

? **It isn't the set Traffic information sound volume.**

- ✓ The set sound volume is less than the tuner sound volume.
E38 If the tuner sound volume is louder than the set sound volume, the tuner sound volume is used.

Disc source

? **"AUX EXT" is displayed without achieving External disc control mode.**

- ✓ Unsupported disc changer is connected.
E38 Use the disc changer mentioned in the 'About CD players/disc changers connected to this unit' (page 6) of the section on 'Safety precautions'.

? **The specified disc does not play, but another one plays instead.**

- ✓ The specified CD is quite dirty.
E38 Clean the CD.
- ✓ The disc is loaded in a different slot from that specified.
E38 Eject the disc magazine and check the number for the specified disc.
- ✓ The disc is severely scratched.
E38 Try another disc instead.

? **A CD ejects as soon as it is loaded.**

- ✓ The CD is quite dirty.
E38 Clean the CD, referring to the CD cleaning of the section on 'About CDs' (page 8).

? **Can't remove disc.**

- ✓ The cause is that more than 10 minutes has elapsed since the vehicle ACC switch was turned OFF.
E38 The disc can only be removed within 10 minutes of the ACC switch being turned OFF. If more than 10 minutes has elapsed, turn the ACC switch ON again and press the Eject button.

? **The disc won't insert.**

- ✓ There's already another disc inserted.
E38 Press the [▲] button and remove the disc.

? **Direct Search can't be done.**

- ✓ Another function is ON.
E38 Turn Random Play or other functions OFF.

? **Track Search can't be done.**

- ✓ For the discs/folders first or last song.
E38 For each disc/folder, Track Search can't be done in the backward direction for the first song or in the forward direction for the last song.

Troubleshooting Guide

MP3/WMA source

? Cannot play an MP3/WMA.

- ✓ The media is scratched or dirty.
 - ☞ Clean the media, referring to the CD cleaning of the section on 'About CDs' (page 8).

? The sound skips when an MP3/WMA is being played.

- ✓ The media is scratched or dirty.
 - ☞ Clean the media, referring to the CD cleaning of the section on 'About CDs' (page 8).
- ✓ The recording condition is bad.
 - ☞ Record the media again or use another media.

? The MP3/WMA track time isn't displayed correctly.

- ✓ ---
 - ☞ There are times when it isn't displayed correctly according to the MP3/WMA recording conditions.

HD Radio source

? No sound can be heard, or the volume is low.

- ✓ The preset broadcast station is not transmitting in the mode that was set with 'Receive mode Setting' (page 50).
 - ☞ Please set 'Receive mode Setting' to "Auto".
- ✓ In digital AM broadcasting, receive mode switches between stereo and monaural too often.
 - ☞ Receiving condition is bad or unstable. Stereo is chosen when receiving condition is good, and it switches to monaural when the condition becomes bad.
- ✓ HD Radio tuner is connected to KCA-S210A or other units.
 - ☞ Connect the HD Radio tuner directly to the control unit.

If the following situations, consult your nearest service center:

Even though the disc changer is connected, the Disc Changer source is not ON, with "AUX EXT" showing in the display during the Changer Mode.

The messages shown below display your systems condition.

- Eject: No disc magazine has been loaded in the changer. The disc magazine is not completely loaded.
☞ Load the disc magazine properly.
No CD in the unit.
☞ Insert the CD.
- No Disc: No disc has been loaded in the disc magazine.
☞ Load a disc into the disc magazine.
- TOC Error: No disc has been loaded in the disc magazine.
☞ Load a disc into the disc magazine. The CD is quite dirty. The CD is upside-down. The CD is scratched a lot.
☞ Clean the CD and load it correctly.
- E-05: The CD is upside-down.
☞ Load the CD correctly.
- Blank Disc: Nothing has been recorded on the MD.
- No Track Disc: No tracks are recorded on the MD, although it has a title.
- E-15: Media was played that doesn't have data recorded that the unit can play.
☞ Use media that has data recorded that the unit can play.
- No Music Data: Media was played that doesn't have data recorded that the unit can play.
☞ Use media that has data recorded that the unit can play. Files for picture downloading only are recorded in CD-R/CD-RW.
- No Panel: The faceplate of the slave unit being connected to this unit has been removed.
☞ Replace it.
- E-77: The unit is malfunctioning for some reason.
☞ Press the reset button on the unit. If the "E-77" code does not disappear, consult your nearest service center.
- Mecha Error: Something is wrong with the disc magazine. Or the unit is malfunctioning for some reason.
☞ Check the disc magazine. And then press the reset button on the unit. If the "Mecha Error" code does not disappear, consult your nearest service center.

Hold Error:	The protective circuit in the unit activates when the temperature inside the automatic disc changer exceeds 60°C (140°F), stopping all operation. ⇨ Cool down the unit by opening the windows or turning on the air conditioner. As the temperature falls below 60°C (140°F), the disc will start playing again.	No Display File:	No file that can be downloaded is contained in the CD-ROM. ⇨ Make sure that a files created with referring to <http://www.kenwood.net_disp.com> is contained in the CD-ROM. Do not delete the extension (.kbn) created when the file was created.
NO NAME:	<ul style="list-style-type: none"> • Attempted to display DNPS during the CD play having no disc names preset. • Attempted to display SNPS during the receiving session of the station having no station name preset. • Attempted to display the ID3 tag while the MP3/WMA having no ID3 tag is being played. 	Incorrect File:	The file selected to be downloaded has a format that this unit cannot read. ⇨ Recreate the file.
Waiting:	Radio text data is being received.	Writing Error:	Writing failed while the file was downloaded. ⇨ Try the downloading again.
Load:	Discs are being exchanged in the Disc changer.	DEMO MODE:	The Demonstration mode has been selected. ⇨ Hold down button [5] and press the Reset button to release the Demonstration mode.
Reading:	The unit is reading the data on the disc.		
NO ACCESS:	After setting it in the Disc Changer, DNPP was done without having it been played at least 1 time.		
IN (Blink):	The CD player section is not operating properly. ⇨ Reinsert the CD. If the CD cannot be ejected or the display continues to flash even when the CD has been properly reinserted, please switch off the power and consult your nearest service center.		
Unsupported File:	A MP3/WMA is played with a format that this unit can't support. ⇨ ----		
Protected File:	A copy-protected file is played. ⇨ ----		
Can't Download/ Download Error:	This unit does not work properly for some reason. ⇨ Press the reset button to download it again. If this error is still displayed, consult a local Kenwood dealer.		

Specifications

Specifications subject to change without notice.

FM tuner section

- Frequency range (200 kHz space)
 - : 87.9 MHz – 107.9 MHz
- Usable sensitivity (S/N = 30dB)
 - : 9.3dBf (0.8 μ V/75 Ω)
- Quieting Sensitivity (S/N = 50dB)
 - : 15.2dBf (1.6 μ V/75 Ω)
- Frequency response (\pm 3.0 dB)
 - : 30 Hz – 15 kHz
- Signal to Noise ratio (MONO)
 - : 70 dB
- Selectivity (\pm 400 kHz)
 - : \geq 80 dB
- Stereo separation (1kHz)
 - : 40 dB

AM tuner section

- Frequency range (10 kHz space)
 - : 530 kHz – 1700 kHz
- Usable sensitivity (S/N = 20dB)
 - : 28dB μ (25 μ V)

CD player section

- Laser diode
 - : GaAlAs
- Digital filter (D/A)
 - : 8 Times Over Sampling
- D/A Converter
 - : 1 Bit
- Spindle speed (CD-DA) (MP3) (WMA)
 - : 1000 – 400 rpm (CLV 2times)
- Wow & Flutter
 - : Below Measurable Limit
- Frequency response (\pm 1 dB)
 - : 10 Hz – 20 kHz
- Total harmonic distortion (1 kHz)
 - : 0.01 % (KDC-MP925)
 - : 0.008 % (KDC-X979/X879)
- Signal to Noise ratio (1 kHz)
 - : 105 dB (KDC-MP925)
 - : 110 dB (KDC-X979/X879)
- Dynamic range
 - : 93 dB
- Channel separation
 - : 95 dB
- MP3 decode
 - : Compliant with MPEG-1/2 Audio Layer-3
- WMA decode
 - : Compliant with Windows Media Audio

Audio section

- Maximum output power
 - : 50 W x 4
- Full Bandwidth Power (at less than 1% THD)
 - : 22 W x 4
- Tone action (KDC-X879)
 - Bass : 60 Hz – 150 Hz \pm 8 dB
 - Middle : 500 Hz – 2 kHz \pm 8 dB
 - Treble : 10 kHz – 17.5 kHz \pm 8 dB
- (KDC-MP925)
 - Bass : 100 Hz \pm 8 dB
 - Middle : 1 kHz \pm 8 dB
 - Treble : 12.5 kHz \pm 8 dB
- (KDC-X979)
 - Bass : 60 Hz – 400 Hz \pm 9 dB
 - Middle : 500 Hz – 3.15 kHz \pm 9 dB
 - Treble : 4 kHz – 16 kHz \pm 9 dB
- Preout level / Load (during disc play)
 - : 5000 mV/10 k Ω
- Preout impedance (during disc play)
 - : \leq 80 Ω

Auxiliary input

- Frequency response (\pm 1 dB)
 - : 20 Hz – 20 kHz
- Input Maximum Voltage
 - : 1200 mV
- Input Impedance
 - : 100 k Ω

General

- Operating voltage (11 – 16V allowable)
 - : 14.4 V
- Current consumption
 - : 10 A
- Installation Size (W x H x D)
 - : 7-3/16 x 2-1/16 x 6-7/16 inch
 - : 182 x 53 x 163 mm (KDC-X979)
 - : 7-3/16 x 2-1/16 x 6-3/8 inch
 - : 182 x 53 x 162 mm (KDC-MP925/X879)
- Weight
 - : 4.63 lbs (2.1 kg) (KDC-X979)
 - : 4.19 lbs (1.9 kg) (KDC-MP925/X879)

Free Manuals Download Website

<http://myh66.com>

<http://usermanuals.us>

<http://www.somanuals.com>

<http://www.4manuals.cc>

<http://www.manual-lib.com>

<http://www.404manual.com>

<http://www.luxmanual.com>

<http://aubethermostatmanual.com>

Golf course search by state

<http://golfingnear.com>

Email search by domain

<http://emailbydomain.com>

Auto manuals search

<http://auto.somanuals.com>

TV manuals search

<http://tv.somanuals.com>