

KENWOOD

KMD-D401

3 DISC AND 1 DISC MD AUTO CHANGER
INSTRUCTION MANUAL

KENWOOD CORPORATION

B64-1955-00 (EN)



Contents

Before use	
Safety Precautions	2
Operations	
Buttons and Display	5
MD Changer Play	6
Plus-one MD play	7
Switching Spectrum Analyzer Display.....	7
Menu Systems.....	8
Theft Deterrent Faceplate	9
Installation	
Accessories.....	10
Installation Procedure.....	10
Connections	11
Installation	11
Troubleshooting guide	13
Specifications	15

Safety precautions

▲WARNING

To prevent injury or fire, take the following precautions:

- Insert the unit all the way in until it is fully locked in place. Otherwise it may fall out of place when jolted.
- To prevent a short circuit, never put or leave any metallic objects (such as coins or metal tools) inside the unit.
- If the unit starts to emit smoke or strange smells, turn off the power immediately and consult your Kenwood dealer.
- Make sure not to get your fingers caught between the faceplate and the unit.
- Be careful not to drop the unit or subject it to strong shock.
The unit may break or crack because it contains glass parts.

US and foreign patents licensed from Dolby Laboratories.

⚠ CAUTION

To prevent damage to the machine, take the following precautions:

- Make sure to ground the unit to a negative 12V DC power supply.
- Do not open the top or bottom covers of the unit.
- Do not install the unit in a spot exposed to direct sunlight or excessive heat or humidity. Also avoid places with too much dust or the possibility of water splashing.
- Do not set the removed faceplate or the faceplate case in areas exposed to direct sunlight, excessive heat or humidity. Also avoid places with too much dust or the possibility of water splashing.
- To prevent deterioration, do not touch the terminals of the unit or faceplate with your fingers.
- Do not subject the faceplate to excessive shock, as it is a piece of precision equipment.
- Do not place any object between the faceplate and the unit.
- During installation, do not use any screws except for the ones provided. The use of improper screws might result in damage to the main unit.

The marking of products using lasers (Except for some areas)

**CLASS 1
LASER PRODUCT**

The label is attached to the chassis/case and says that the component uses laser beams that have been classified as Class 1. It means that the unit is utilizing laser beams that are of a weaker class. There is no danger of hazardous radiation outside the unit.

**Setting of the O-N switch will be required depending on the centre unit that is to be connected. (See page 10.)
The operations you perform and the resultant operation of the unit will differ depending on the setting of the O-N switch. Please see the appropriate description of operations for the "O" or "N" switch setting.**

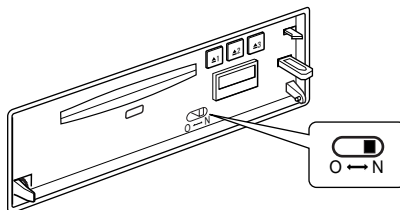

Cleaning the Unit

If the faceplate of this unit is stained, wipe it with a dry soft cloth such as a silicon cloth. If the faceplate is stained badly, wipe the stain off with a cloth moistened with neutral cleaner, then wipe neutral detergent off.

⚠ CAUTION

Applying spray cleaner directly to the unit may affect its mechanical parts. Wiping the faceplate with a hard cloth or using a volatile liquid such as thinner or alcohol may scratch the surface or erases characters.

Cleaning the Faceplate Terminals

If the terminals on the unit or faceplate get dirty, wipe them with a dry, soft cloth.

Lens Fogging

Right after you turn on the car heater in cold weather, dew or condensation may form on the lens in the MD player of the unit. Called lens fogging, MDs may be impossible to play. In such a situation, remove the disc and wait for the condensation to evaporate. If the unit still does not operate normally after a while, consult your Kenwood dealer.

Safety precautions

IMPORTANT INFORMATION

This unit is NOT designed to be connected directly to control units that are manufactured and sold before 1994. If used with such units, an optional CA-SD200 (sold separately) must be used.

FAILURE TO FOLLOW THESE INSTRUCTIONS MAY RESULT IN DAMAGE TO THIS UNIT AND CONTROL UNIT.

Handling Mini discs

- The MD shutter is designed so that it cannot be opened. If forced open, the cartridge will be damaged and use of the MD will no longer be possible. If the shutter has been opened due to some cause, be careful not to touch the recording portion with a finger. Doing so will cause the sound to skip.

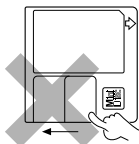

- Do not use an MD that has a peeling label. Use of an MD that has a loose or peeling label may cause problems, such as the label coming off inside the player and the resultant inability to eject the MD.
- Wipe away dirt or dust from the cartridge surface with a dry cloth before use. Using an oil-soiled cartridge in particular may result in the disc not loading or being unable to eject it. (At time of cleaning, be careful not to open the shutter.)

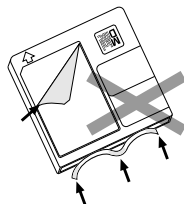

- Do not leave the MD in the unit for a prolonged period. The ejected MD should be placed in an MD case for storage.
- Do not leave the MD in a place exposed to direct sunlight (such as on a instrument panel) or in other places that reach high temperatures. The MD cartridge will become misshapen and will no longer be usable.
- MDs designed for use with data cannot be used. Please use MDs designed for music.
- Do not use lens cleaners. Doing so will lead to breakdown.
- If the MD performance time exceeds 100 minutes, the lower two digits are displayed for the performance time.

Operations

Buttons and Display

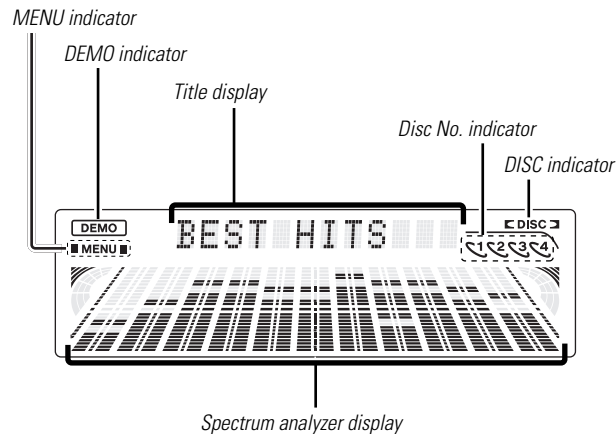
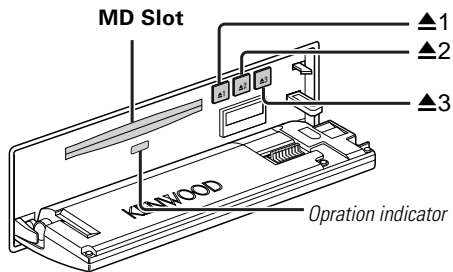
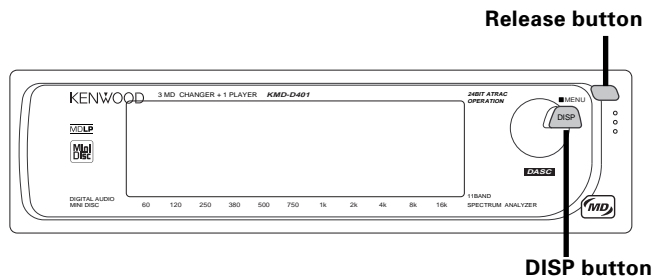

Operations

MD Changer Play

To set MDs in the main unit:

- 1 Insert the first MD in the MD slot.
The first MD is set in the play position.
- 2 Insert the second MD in the MD slot.
The second MD is held in the disc No.2 stack position.
- 3 Insert the third MD in the MD slot.
The third MD is held in the disc No.3 stack position.

NOTE

- The ▲ buttons change colour according to the operation state, as follows.
If a disc is present in the stack position:
The ▲ button corresponding to the disc number glows red.
If no disc is present in the stack position:
The ▲ button corresponding to the disc number glows green.
- An MD cannot be inserted while the operation indicator is red. Wait until it changes to green, then insert the MD.
- When an MD is inserted, it will be stored as the smallest available disc number. For example, if disc No.1 and disc No.2 are both empty, the inserted disc will be denoted as disc No.1.

To play an MD:

Select the disc changer mode on the centre unit.

NOTE

- If your system is connected to a centre unit brought on to the market in 1999 or later (excluding certain models), it will automatically switch to MD play mode when the first MD is inserted, even if there are other sources.
- The ▲ button with the disc number corresponding to the MD currently playing will blink red.

To switch the MD:

Select the disc number using the DISC+ or DISC- button on the centre unit.

Disc No.1 being played: the ↶ indicator blinks

Disc No.2 being played: the ↷ indicator blinks

Disc No.3 being played: the ↸ indicator blinks

To store an MD:

Press one of the ▲1 - ▲3 buttons for at least one second.

The MD currently set in the play position will be stored in the stacker position.

NOTE

When an MD has been stored in the stack position, the unit will enter one of the states listed below, depending on the type of centre unit connected.

Centre units brought on to the market in 1998 or earlier:

The system will remain in the disc play STOP state.

Centre units brought on sale in 1999 or later (certain models excluded):

The system will switch to the tuner mode.

To eject an MD:

Press one of the ▲1 - ▲3 buttons depending on the disc you want to remove.

NOTE

The ▲ button with the disc number corresponding to the MD currently being ejected will blink green.

NOTE

When the O-N switch is set to "O", the phrase "NO NAME" will be displayed if the centre unit display is switched accordingly, but the DNPS (Disc Name Pre-Set) function cannot be used on the MD in the main unit.

Plus-one MD play

Even when three MDs have been set in the main unit, a further MD can be played as the plus-one MD.

To play a plus-one MD (a fourth MD):

- 1 Press one of the $\blacktriangle 1$ - $\blacktriangle 3$ buttons for at least one second. The MD currently set in the play position will now be stored in the stack position.
- 2 Insert the MD in the MD slot. The disc is then set in the play position. The \heartsuit indicator blinks and the disc begins to play.

NOTE

- While the plus-one MD is being played, the buttons $\blacktriangle 1$ to $\blacktriangle 3$ will blink red.
- An MD cannot be inserted when the operation indicator is red. Wait until it goes green, and then insert the MD.
- When a plus-one MD has been set in the main unit, the disc cannot be changed or the disc scan switched ON/OFF from the centre unit, nor can random magazine playback be switched ON/OFF from the centre unit.
- While the plus-one MD is playing, the disc repeat function will operate, but it cannot be cancelled from the centre unit.

To remove the plus-one MD:

Press one of the $\blacktriangle 1$ - $\blacktriangle 3$ buttons.

NOTE

While the plus-one MD is being ejected, the buttons $\blacktriangle 1$ to $\blacktriangle 3$ will blink green.

Switching Spectrum Analyzer Display

You can select the display to enjoy sounds with eyes.

Operation for "N" Setting:

Each time you press the DISP button, the spectrum analyzer display switches as follows;

Operation for "O" Setting:

- 1 Selecting MD play source mode.
- 2 Each time you press the DISP button, the spectrum analyzer display switches as follows;

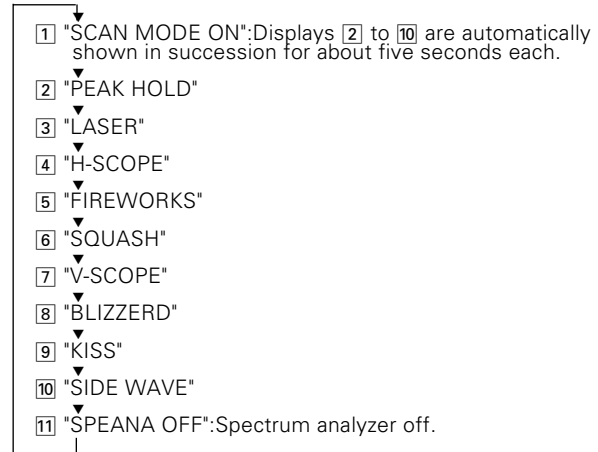

NOTE

- The spectrum analyzer name is not shown while the disc title or track title is being displayed.
- During operation 1, the DEMO indicator will light.

Operations

Menu System

To accommodate a greater number of functions, a function set system has been employed for making settings. Press the DISP button to enter the function set mode and then display the function to make the setting.

- 1 Selecting MD play source mode.
- 2 Press the DISP button for at least one second, enter the function set mode.
- 3 Press either the ◀◀ or ▶▶ button on the centre unit. Each time the button is pressed, the adjustment mode will change as follows:

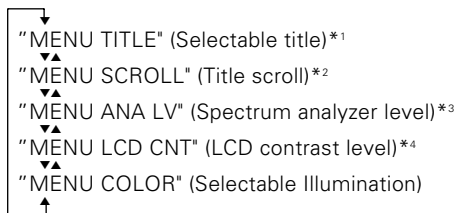

- 4 Press the DISC+ or DISC- button on the centre unit. Look at the table to adjust the mode being displayed.
- 5 Press the DISP button to end the function set mode.

Table of Adjustment Mode

Adjustment mode (Display)	Operation of Control button	
	DISC+ button	DISC- button
Selectable title*1 ("TITLE")	<div style="border: 1px solid black; padding: 5px; display: inline-block;"> → Analyzer title ("ANA") ↔ Disc title("DISC") ← → Track title ("TRACK") ← </div>	
Title scroll*2 ("SCROLL")	Automatic scrolling ("AUTO") ↔ Off ("OFF")	
Spectrum Analyzer level*3 ("ANA LV")	The spectrum analyzer level increased.	The spectrum analyzer level decreased.
LCD contrast level*4 ("LCD CNT")	The setting values higher.	The setting values lower.
Selectable Illumination ("COLOR")	Green("GREEN") ↔ Red("RED")	

NOTE

- *1: The spectrum analyzer name is not shown while the disc title or track title are being displayed.
- *2:
 - Even when the system is set to "OFF", the title will appear once on the scroll display if the track or the disc is switched.
 - The analyzer name is shown at all times on the scroll display.
- *3: The volume changes according to the volume setting on the centre unit, so set the centre unit to a normal volume level before adjusting it.
- *4: The contrast on the spectrum analyzer display is not adjustable.

Theft Deterrent Faceplate

The faceplate of the unit can be detached and taken with you, helping to deter theft.

Removing Faceplate:

Press the release button and drop open the faceplate.

In its dropped condition, whilst drawing the faceplate to one side, pull it to the front and remove it.

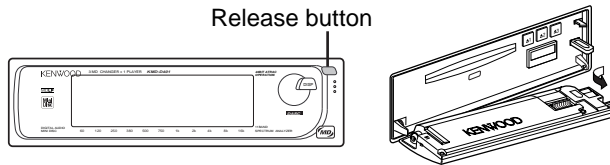

NOTE

- If the controls remain untouched for a period of 5 minutes or more after the panel has dropped open or been removed, the disc will automatically stop playing. (A warning beep starts sounding 30 seconds before play stops automatically.)
- The faceplate is a precision piece of equipment and can be damaged by shocks or jolts. For that reason, keep the faceplate in its special storage case whilst detached.
- Do not expose the faceplate or its storage case to direct sunlight or excessive heat or humidity. Also avoid places with too much dust or the possibility of water splashing.

Reattaching Faceplate:

Hold the faceplate so that the operation face faces the front toward you and press until it locks. The faceplate will be set and the unit will be operational.

NOTE

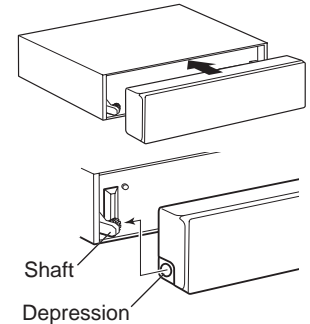

When there is difficulty in setting the faceplate, align the depression on the left side of the faceplate with the shaft of the unit, then lock.



Accessories

External view

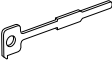
..... Number of items

- | | | |
|---|---|--------|
| ① |  |2 |
| ② |  |2 |
| ③ |  |1 |

▲CAUTION

The use of any accessories except for those provided might result in damage to the unit. Make sure only to use the accessories shipped with the unit, as shown above.

Installation Procedure

The O-N switch should be set according to the control unit in use as well as to the connected models.

When the centre unit is compatible with the "N"-operation, set the O-N switch to "N". When it is not compatible with the "N"-operation, set the O-N switch to "O" because the operation is not available. The initial setting of the switch is "N".(see page 3)

1. To prevent a short circuit, remove the key from the ignition and disconnect the ⊖ battery.
2. Set the O-N switch of this unit to suit the centre unit.
3. Connect the speaker input wires to the front speaker wires of the wiring harness of the centre unit.
4. Connect the control cable to the control connector.
5. Install the unit in your car.
6. Reconnect the ⊖ battery.
7. Press the reset button on the centre unit.

▲CAUTION

- Do not connect the changer control cable while the centre unit is turned on.
- Be sure to press the reset button after installation.
- Whether the centre unit in use is compatible with the "N"-operation or not can be identified by referring to its instruction manual (description of the disc control mode, etc.).
- If you use the changer switching unit, see the instruction manual for the KCA-S210A included in the unit. Set the O-N switch on the KCA-S200 to "O".
- Do not let unconnected wires or terminals touch metal on the car or anything else conducting electricity. To prevent a short circuit, do not remove the caps on the ends of the unconnected wires or the terminals.
- After the unit is installed, check whether the brake lamps, blinkers, wipers, etc. on the car are working properly.
- Mount the unit so that the mounting angle is 30° or less.

Connections

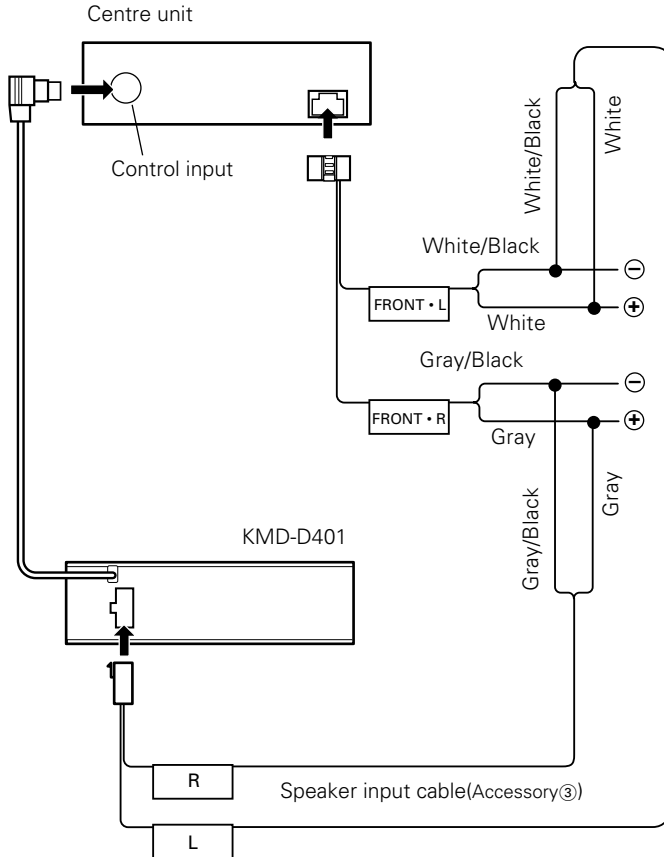

CAUTION

If the speaker input cable is not connected, or connected wrongly, the spectrum analyzer will not be displayed.

Installation

Installation

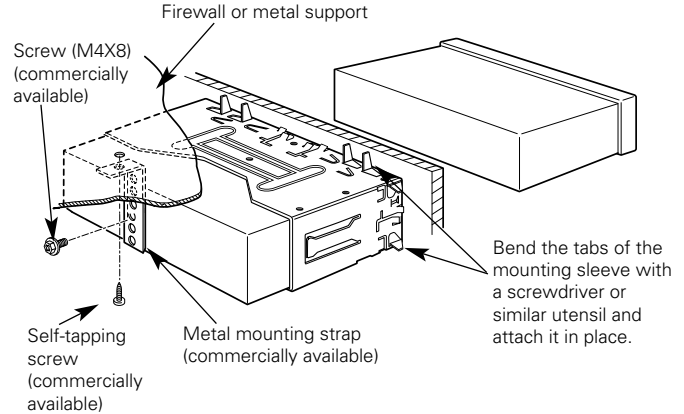

On cars where there is no compartment in the centre for installing a car audio unit:

Use the spacer ② to affix the centre unit sleeve and the sleeve attached to the main unit in such a way that they are correctly aligned both depthwise and horizontally.

On cars lacking a centre compartment

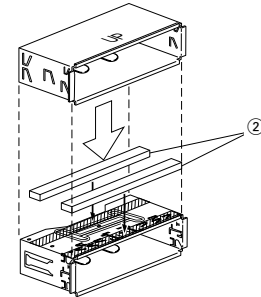
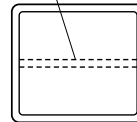

Installation

■ Removing the hard rubber frame

- 1 Engage the catch pins on the removal tool and remove the two locks on the lower level.
Lower the frame and pull it forward as shown in the figure.

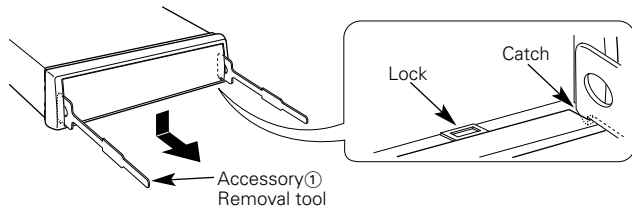

- 2 When the lower level is removed, remove the upper two locations.

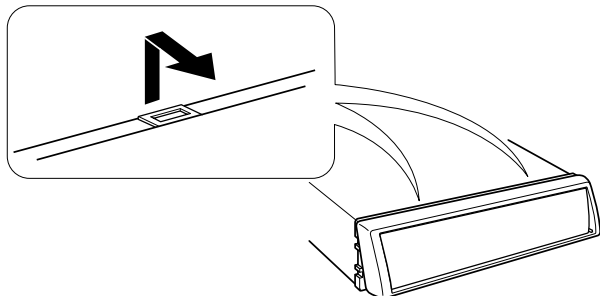

NOTE

The frame can be removed from the top side in the same manner.

■ Removing the Unit

- 1 Refer to the section "Removing the hard rubber frame" and then remove the hard rubber frame.
- 2 Remove the Hex-head screw with integral washer (M4x8) on the back panel.
- 3 Insert the two removal tools deeply into the slots on each side, as shown.

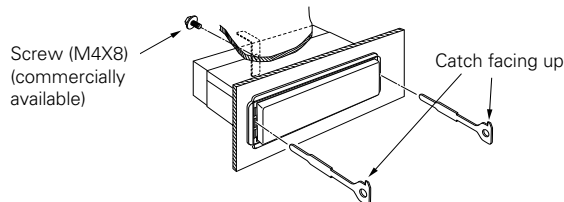

- 4 Lower the removal tool toward the bottom, and pull out the unit halfway whilst pressing towards the inside.

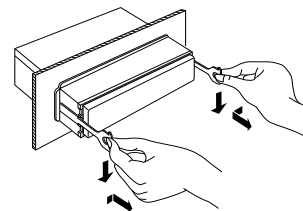

CAUTION

Be careful to avoid injury from the catch pins on the removal tool.

- 5 Pull the unit all the way out with your hands, being careful not to drop it.

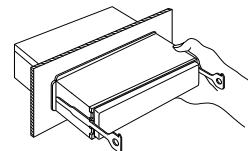

Troubleshooting Guide

What might seem to be a malfunction in your unit may just be the result of slight misoperation or miswiring. Before calling service, first check the following table for possible problems.

PROBLEM	POSSIBLE CAUSE	SOLUTION
The disc control mode cannot be selected.	No cable has been connected to the disc changer input terminal on the unit.	Connect the control cable to the disc changer input terminal on the centre unit.
The disc cannot be changed.	Four MDs have been set in the main unit.	Remove the MD currently playing.
No sound can be heard, or the volume is low.	Attenuator is turned on.	Turn off Attenuator.
	The fader or balance settings are set all the way to one side.	Reset the fader or balance settings.
	5 minutes have elapsed since the panel dropped open.	When 5 minutes have elapsed since the panel dropped open, the disc will automatically stop playing.
The spectrum analyzer is not displayed.	The speaker input cable is not connected.	Refer to the "Connections" section, and connect the cable.
	The fader setting has been adjusted to the rear side.	Adjust the fader control on the centre unit to the centre position.
	The analyzer display level has been set too low.	Adjust it to a higher level.
	The volume is too low.	Raise the volume, or alternatively, adjust the analyzer display level to a higher level.
Nothing happens when the buttons are pressed.	The computer chip in the unit is not functioning normally.	Press the reset button on the centre unit.
The MD cannot be inserted.	There is already an MD loaded.	Eject the currently loaded MD and then load the new one.
The MD does not load.	The insertion orientation of the MD is incorrect or the MD is upside down.	Insert the MD in the proper orientation.
The MD loads but soon comes out again.	Nothing is recorded on the MD.	Switch the MD for one that is recorded.
A track will not play.	Random play has been selected.	Turn off random play.
The system will not enter the Menu mode.	The system is not in MD play mode.	If the main unit is not in MD play mode, it will not go into the Menu mode.

Troubleshooting Guide

The following messages are displayed on the centre unit when certain problems are occurring in your system. Take the recommended actions.

E-01 / EJECT	No MD is loaded.
E-04	<ul style="list-style-type: none">• The MD is extremely soiled.• The MD has so many scratches.
NO PANEL E-30	The faceplate of this unit has been removed. ⇒ Replace it.
BLANK	Nothing has been recorded on the MD. ⇒ The next MD will automatically be played.
NO TRACK	No tracks are recorded on the MD, although it has a title. ⇒ The next MD will automatically be played.
E-99 Mecha Error	The unit is malfunctioning for some reason. ⇒ Press the reset button on the centre unit. If the "E- 99" / "Mecha Error" code does not disappear, consult your nearest service centre.
E-0d HOLD	The protective circuit in the unit activates when the temperature inside the MD player exceeds 60°C (140°F), stopping all operation. ⇒ Cool down the unit by opening the windows or turning on the air conditioner. As the temperature falls below 60°C (140°F), the disc will start playing again.

Specifications

Specifications subject to change without notice.

MD player section

Laser diode	GaAlAs ($\lambda=780$ nm)
Digital filter (D/A)	8 Times Over Sampling
D/A Converter	20 Bit
Frequency response (± 1 dB)	5 Hz – 20 kHz
Total harmonic distortion (1 kHz)	0.03 %
Signal to Noise ratio	90 dB (1 kHz)
Dynamic range	87 dB
Channel separation	80 dB
Spindle speed	400 – 900 rpm (CLV)
Wow & Flutter	Below Measurable Limit

General

Operating voltage	14.4 V (11 – 16 V allowable)
Current consumption	0.8 A
Installation size (W x H x D)	180 x 50 x 160 mm
	7-1/16 x 1-15/16 x 6-1/16 in.
Weight	1.3 kg (2.9 Lbs)

KENWOOD

Free Manuals Download Website

<http://myh66.com>

<http://usermanuals.us>

<http://www.somanuals.com>

<http://www.4manuals.cc>

<http://www.manual-lib.com>

<http://www.404manual.com>

<http://www.luxmanual.com>

<http://aubethermostatmanual.com>

Golf course search by state

<http://golfingnear.com>

Email search by domain

<http://emailbydomain.com>

Auto manuals search

<http://auto.somanuals.com>

TV manuals search

<http://tv.somanuals.com>