

# KENWOOD

**KRC-477R**

**KRC-477RV**

**KRC-377R**

**KRC-32R**

CASSETTE RECEIVER

## **INSTRUCTION MANUAL**

KENWOOD CORPORATION

© B64-1326-00 (EW)

## Contents

### **Before use**

Safety precautions .....	3
--------------------------	---

### **Basic operations**

Power .....	5
Switching Modes .....	5
Volume .....	5
Attenuator .....	6
Loudness .....	6
Menu System .....	6

### **Tuner features**

Selecting Tuning Mode .....	8
Tuning .....	8
Local Seek Function .....	8
Monaural Reception .....	8
Station Preset Memory .....	9
Auto Memory Entry .....	9
Preset station seek with Programme service name .....	10
Switching Display for Tuner .....	10

### **RDS features**

RDS (Radio Data System) .....	11
EON (Enhanced Other Network) .....	11
Alarm .....	11
AF (Alternative Frequency) Function .....	12
Restricting RDS Region (Region Restrict Function) .....	12
Auto TP Seek Function .....	12
Traffic Information Function .....	13
Presetting Volume for Traffic Information/News .....	13
News Bulletin Function with PTY News Timeout Setting .....	14
Programme Type (PTY) Function .....	14

### **Cassette player features**

Playing Cassette Tapes .....	16
Fast Forwarding and Rewinding Cassette Tapes .....	16
Blank Skip .....	17
Tuner Call .....	17
Tape Advance .....	17
Music Repeat .....	17
Clock display .....	18

### **External disc control features**

Playing Disc mode .....	19
Fast Forwarding and Reversing Disc Play .....	19
Track Search .....	20
Disc Search .....	20
Track / Disc Repeat .....	20
Track Scan .....	20
Disc Scan .....	21
Random Play .....	21
Magazine Random Play .....	22
Presetting Disc Names .....	22
Disc Name Preset Play (DNPP) .....	23
Text / Title Scroll .....	24
Switching Display for Discs .....	24

### **Other features**

Selectable Illumination .....	25
Audio Control Setting .....	26
Adjusting Time .....	26
TEL Mute .....	27
Touch Sensor Tone .....	27
Navigation Mute Function .....	27
Disabled System Indicator (DSI) .....	28
Theft Deterrent Faceplate .....	28

### **Installation**

Accessories .....	29
Installation Procedure .....	29
Connecting Cables to Terminals .....	30
Installation .....	33

### **Troubleshooting guide .....35**

### **Specifications .....38**

## Safety precautions

### ⚠ WARNING

**To prevent injury and/or fire, take the following precautions:**

- Insert the unit all the way until it is fully locked in place. Otherwise it may fly out of place during collisions and other jolts.
- When extending the ignition, battery or ground cables, make sure to use automotive-grade cables or other cables with an area of 0.75mm<sup>2</sup> (AWG18) or more to prevent cable deterioration and damage to the cable coating.
- To prevent short circuits, never put or leave any metallic objects (e.g., coins or metal tools) inside the unit.
- If the unit starts to emit smoke or strange smells, turn off the power immediately and consult your Kenwood dealer.
- Make sure not to get your fingers caught between the faceplate and the unit.
- Be careful not to drop the unit or subject it to strong shock.  
The unit may break or crack because it contains glass parts.
- Do not touch the liquid crystal fluid if the LCD is damaged or broken due to shock. The liquid crystal fluid may be dangerous to your health or even fatal.  
If the liquid crystal fluid from the LCD contacts your body or clothing, wash it off with soap immediately.

### ⚠ CAUTION

**To prevent damage to the machine, take the following precautions:**

- Make sure to ground the unit to a negative 12V DC power supply.
- Do not open the top or bottom covers of the unit.
- Do not install the unit in a spot exposed to direct sunlight or excessive heat or humidity. Also avoid places with too much dust or the possibility of water splashing.
- Do not set the removed faceplate or the faceplate case in areas exposed to direct sunlight, excessive heat or humidity. Also avoid places with too much dust or the possibility of water splashing.
- To prevent deterioration, do not touch the terminals of the unit or faceplate with your fingers.
- Do not subject the faceplate to excessive shock, as it is a piece of precision equipment.
- When replacing a fuse, only use a new one with the prescribed rating. Using a fuse with the wrong rating may cause your unit to malfunction.
- To prevent short circuits when replacing a fuse, first disconnect the wiring harness.
- Do not place any object between the faceplate and the unit.
- During installation, do not use any screws except for the ones provided. The use of improper screws might result in damage to the main unit.

### IMPORTANT INFORMATION

*You cannot connect the unit directly to the following CD automatic changers. For users who want to use older changers with the unit, follow the directions below according to the type of changer you own:*

#### • KDC-C200 / KDC-C300 / KDC-C400

Use the extension cable and the control box attached to the CD changer, and the optional CA-DS100 converter cable.

#### • KDC-C301 / KDC-C600 / KDC-C800 / KDC-C601 / KDC-C401

Use the extension cable attached to the CD changer, and the optional CA-DS100 converter cable.

#### • KDC-C100 / KDC-C302 / C205 / C705 / non-Kenwood CD changers

Cannot be used with this model.

### ⚠ CAUTION

***You can damage both your unit and the CD changer if you connect them incorrectly.***

## Safety precautions

### NOTE

- If you experience problems during installation, consult your Kenwood dealer.
- If the unit does not seem to be working right, try pressing the reset button first. If that does not solve the problem, consult your Kenwood dealer.

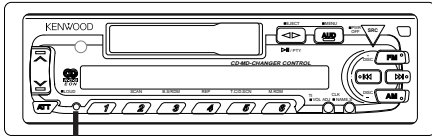

Reset button

- Characters in the LCD may become difficult to read in temperatures below 41 °F (5 °C).

### Cleaning the Faceplate Terminals

If the terminals on the unit or faceplate get dirty, wipe them with a dry, soft cloth.

### Cleaning the Unit

If the front panel gets dirty, turn off the power and wipe the panel with a dry silicon cloth or soft cloth.

### CAUTION

Do not wipe the panel with a stiff cloth or a cloth dampened by volatile solvents such as paint thinner and alcohol. They can scratch the surface of the panel and/or cause the indicator letters to peel off.

### Cleaning the Tape Head

After you have used the tape player many times over a long period, magnetic powder from the tapes and dust accumulates on the tape head, causing noise and a deterioration in sound quality. Clean the tape head using a cleaning tape or cleaning kit designed for use in car audio systems.

### Handling Cassette Tapes

- Do not play a cassette whose tape has gone slack. In such a case, wind it tight using a pencil or the like in one of the spools. Playing slack cassette tapes can result in the tape tangling around the capstan and/or pinch rollers, causing trouble.
- Do not play a deformed cassette or one whose label is starting to come off, as it can cause the unit to malfunction.
- Do not leave tapes in hot places, such as above the fascia panel (dashboard) and other spots exposed to direct sunlight, or near heater outlets. They can deform the cassette.
- Avoid using extremely long cassette tapes, such as 100-minute-long tapes. Such tapes are very thin, and can tangle easily around the pinch rollers or other parts inside the unit, causing unit failure.
- Remove a cassette tape from the unit when not listening to it for a whilst. If you leave a tape in the unit too long, it may stick to the tape head and cause unit malfunction.

## Basic operations

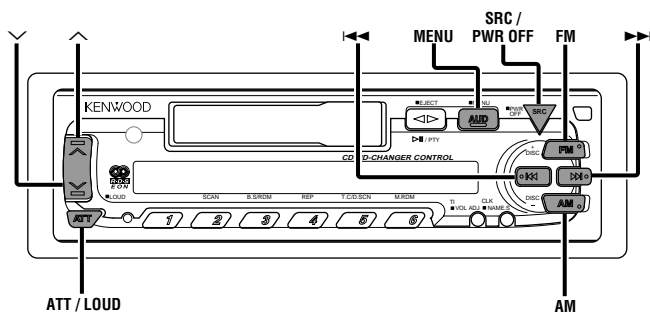

LOUD indicator

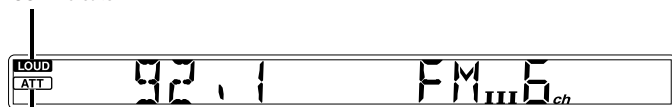

ATT indicator

## Power

### Turning on the power:

Press the SRC button.

#### NOTE

Turn the power on before carrying out the following procedures.

### Turning off the power:

Hold down the PWR OFF button for one second or more.

## Switching Modes

### Switching Modes:

Each time you press the SRC button, the mode switches as follows:

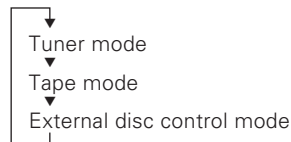

#### NOTE

The mode switches to the next mode from any mode which cannot be used.

## Volume

### Increasing Volume:

Press the ^ button to turn up the volume.

### Decreasing Volume:

Press the v button to turn down the volume.

## Basic operations

### Attenuator

This function allows you to turn down the volume quickly.

#### Turning Attenuator On/Off:

Press the ATT button to switch the attenuator on and off.

When the attenuator is on, the ATT indicator blinks.

When the attenuator is off, the volume returns to the original level.

#### NOTE

Turning down the volume all the way turns off the attenuator function.

### Loudness

This function amplifies low and high tones when the volume is turned down.

The LOUD indicator lights up, when the loudness function is on.

#### Turning Loudness On/Off:

Hold down the LOUD button for one second or more to switch the loudness on and off.

### Menu System

To accommodate a greater number of functions, a menu system has been employed for making settings. Press the MENU button to enter the menu mode and then display the function to make the setting. Details on each setting are explained separately in the corresponding function page.

- 1 Hold down the MENU button for one second or more. "MENU" is displayed when the menu mode is entered. The function that you can adjust is indicated with the current settings displayed.

#### 2 Selecting function to set

Press the ►► button to search through the functions until you see the one you want to adjust in the display.

Press the ◀◀ button to search through the functions backward.

Example: If you want to switch the tuning mode from manual to automatic, first search through the functions until you see "MANUAL" in the display.



#### 3 Changing setting for currently displayed function

Press either the AM or FM button.

The setting will change for each function.

Example: The tuning mode will switch from manual to automatic, and "AUTO" is displayed.



#### 4 Ending the menu mode

Press the MENU button.

The selection includes:

Touch Sensor Tone (BEEP ON / OFF) ↔ Time Adjustment\*<sup>1</sup>  
 <Manual> (CLK ADJ\*<sup>2</sup>) ↔ Automatic Time Adjustment (SYNC  
 ON / OFF) ↔ Disabled System Indicator (DSI ON / OFF) ↔  
 Selectable Illumination (COL GRN / AMB) ↔ News Bulletin  
 Function (NEWS OFF / ##M) ↔ Local seek\*<sup>3</sup> (LO.S OFF / ON)  
 ↔ Selecting Tuning Mode\*<sup>3</sup> (AUTO / MANUAL) ↔ Auto  
 Memory Entry\*<sup>3</sup> (A-MEMORY (start)) ↔ AF Function\*<sup>4</sup> (AF ON /  
 OFF) ↔ Region Restrict Function\*<sup>4</sup> (REG ON / OFF) ↔ Auto TP  
 Seek\*<sup>4</sup> (ATPS ON / OFF) ↔ Monaural Reception\*<sup>5</sup> (MONO OFF  
 / ON) ↔ Text Scroll\*<sup>6</sup> (SCL MANU / AUTO) ↔ Touch Sensor  
 Tone

\*<sup>1</sup> When Automatic Time Adjustment is off

\*<sup>2</sup> Time adjustment mode entered

\*<sup>3</sup> In Tuner mode

\*<sup>4</sup> Except in AM band

\*<sup>5</sup> In FM reception of Tuner mode

\*<sup>6</sup> In External disc control mode

#### NOTE

- Make sure to end the menu mode when finished.

## Tuner features

If you fail to end the menu mode, several functions may not operate properly, including the Traffic Information function, the News Bulletin function with PTY news timeout setting, and the Alarm function.

- The News function turns on when the setting is made for the news interruption interval. The "##M" display indicates the setting selected for the news interruption timeout interval.

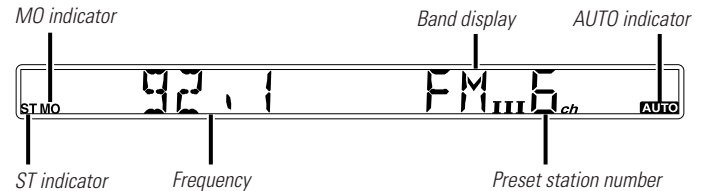
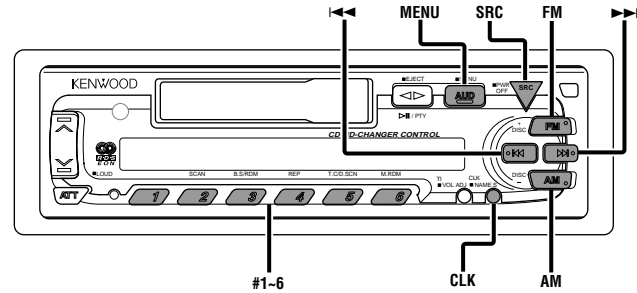

## Tuner features

### Selecting Tuning Mode

Select which tuning mode — auto seek or manual — to use as the default.

When the AUTO indicator is on, auto seek tuning is selected.

When the indicator is off, manual tuning is selected.

- 1 Hold down the MENU button for one second or more. "MENU" is displayed and the menu mode is turned on.
- 2 Press the ►► button repeatedly until the tuning function appears in the display.  
Press the ◄◄ button to search in the other direction.  
The function setting is indicated by "AUTO" or "MANUAL" in the display, indicating auto seek or manual tuning, respectively.
- 3 **Switching settings**  
Press either the AM button or FM button to switch the tuning mode.  
The display and setting will change.
- 4 Press the MENU button to end the menu mode.

### Tuning

- 1 Press the SRC button repeatedly until tuner mode is obtained. "TUNER" is displayed only when the tuner mode is selected.
- 2 Press either the FM or AM button to select the band. Each time you press the FM button, the band switches between the FM1, FM2 and FM3.  
Press the AM button to select the MW and LW bands.
- 3
  - Auto Seek Tuning  
Press the ►► button to seek increasing frequencies.  
Press the ◄◄ button to seek decreasing frequencies.
  - Manual Tuning  
Press the ►► button to increase the frequency by one step.  
Press the ◄◄ button to decrease the frequency by one step.

#### NOTE

The ST indicator lights up when stereo broadcasts are being received.

### Local Seek Function

With the local seek function turned on, auto seek tuning skips stations with relatively poor reception.

#### Turning Local Seek Function On/Off:

- 1 Hold down the MENU button for one second or more. "MENU" is displayed and the menu mode is turned on.
- 2 Press the ►► button repeatedly until the local seek function appears in the display.  
Press the ◄◄ button to search in the other direction.  
The function setting is indicated by "LO.S ON" or "LO.S OFF" in the display, indicating that the local seek function is on or off, respectively.
- 3 **Switching settings**  
Press either the AM button or FM button.  
The display and setting will change.
- 4 Press the MENU button to end the menu mode.

### Monaural Reception

When poor stereo reception is experienced, this function will reduce noise and improve listening conditions.

- 1 Hold down the MENU button for one second or more. "MENU" is displayed and the menu mode is turned on.
- 2 Press the ►► button repeatedly until the monaural reception function appears in the display.  
Press the ◄◄ button to search in the other direction.  
The function setting is indicated by "MONO OFF" or "MONO ON" in the display, indicating that monaural reception is on or off, respectively.  
The MO indicator lights up when monaural reception is on.



### 3 **Switching settings**

Press either the AM button or FM button.  
The display and setting will change.

- 4 Press the MENU button to end the menu mode.

## Station Preset Memory

Store the frequency of the station currently being listened to. You can then recall that station with a single touch of a button.

- 1 Select the band/ station that you want to have stored.
- 2 Hold down the button (#1-6) that you want to use for the station, for two seconds or more.  
The button number blinks once in the display to indicate that the data has been stored.

### **Recalling a Preset Station:**

Press the preset station button (#1-6) for the desired station. The number of the recalled station is displayed.

#### NOTE

You can store 6 stations in each of the FM1, FM2, FM3, and AM (MW and LW) bands.

## Auto Memory Entry

You can automatically store all the receivable frequencies in the band currently being listened to, and then recall them with the touch of a button later. This function is especially useful when you are travelling and do not know what stations are available. Up to 6 frequencies can be stored this way.

- 1 Select the band for auto memory entry.
- 2 Hold down the MENU button for one second or more. "MENU" is displayed and the menu mode is turned on.
- 3 Press the ►► button repeatedly until "A-MEMORY" appears in the display.  
Press the ◀◀ button to search in the other direction.

- 4 Hold down either the AM button or FM button for two seconds or more to start auto memory function.  
The numbers of the preset station buttons showed in order. When all the stations in a certain band are stored in the preset memory, the auto memory entry stops. The tuner then plays the last station received.

### **Recalling a Preset Station:**

Press the preset station button (#1-6) for the desired station. The number of the recalled station is displayed.

#### NOTE

- When the AF function is turned on whilst auto memory entry takes place, only RDS stations (i.e., stations with RDS capability) are stored. RDS stations that have been preset for FM1 cannot also be preset in FM2 or FM3.
- When the local seek function is turned whilst auto memory entry takes place, stations with poor reception are not stored.
- When the Traffic Information function is on, only the local traffic information station frequency will be stored.

### **Cancelling Auto Memory Entry During Its Operation:**

Press the MENU button whilst auto memory entry is taking place to stop the process.

## Tuner features

Function of the KRC-477R/KRC-477RV

### Preset station seek with Programme service name (Function of Remote)

You can search for the preset station with Programme Service name.

- 1 Press the DNPP button on the remote control. "SNPP" will be displayed once the seek mode is entered. The names of the stations preset in the band currently listened to are displayed for 5 seconds each. The display band switches in the following order:

→ FM1 ↔ FM2 ↔ FM3 ↔ AM ←

Each time you press the ►► button, the station display switches in the forward direction.

Each time you press the ◀◀ button, the station display switches in the reverse direction.

Stations which have no names will be displayed as frequencies.

#### **NOTE** Changing the Displayed Band

Pressing the FM button switches between the FM1, FM2, FM3 and AM displays, in that order.

Pressing the AM button switches between the displays in the reverse direction.

- 2 **Once the name is displayed for the station you want to listen to**

Press the OK button.

Reception starts of the displayed station, and the seek mode ends.

#### **Canceling mode during input:**

Press the DNPP button.

The seek mode is cancelled.

### Switching Display for Tuner

#### **Switching the Display:**

Each time you press the CLK button, the display switches between the Programme service name (during RDS station reception)/frequency and clock.

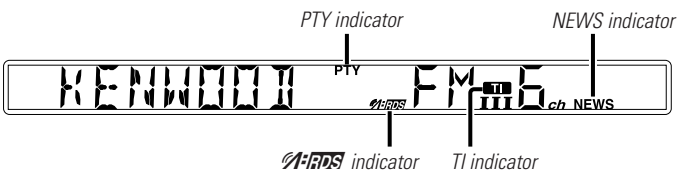
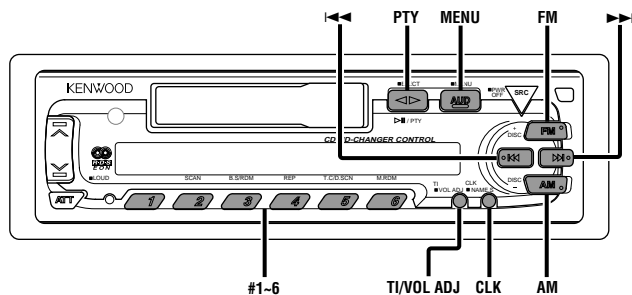

### RDS (Radio Data System)

RDS is a digital information system that lets you receive signals besides those of regular radio programmes, such as network information being transmitted from radio stations.

When listening to an RDS station (ie, a station with RDS capability), the programme service name of the station is displayed along with the frequency, advising you quickly which station is being received.

RDS (Radio Data System) stations also transmit frequency data for the same station. When you are making long trips, this function automatically switches to the particular network of stations that you want to listen to. The data is automatically stored, allowing you to switch quickly to another RDS stations, broadcasting the same programme, that has better reception. These include stations stored in the station preset memory that you often listen to.

### EON (Enhanced Other Network)

Stations that offer EON also transmit information about other RDS stations that have traffic information. When you are tuned to a station that is not transmitting traffic information, but another RDS station starts transmitting a traffic bulletin, the tuner automatically switches to the other station for the duration of the bulletin.

### Alarm

When an emergency transmission (announcing disasters, etc.) is sent, all current functions are interrupted to allow the warning to be received.

## RDS features

### AF (Alternative Frequency) Function

When poor reception is experienced, automatically switch to another frequency broadcasting the same programme in the same RDS network with better reception. The **RDS** indicator lights up when the AF function is turned on.

#### Turning AF Function On/Off:

- 1 Hold down the MENU button for one second or more. "MENU" is displayed and the menu mode is turned on.
- 2 Press the ►► button repeatedly until the AF function appears in the display.  
Press the ◄◄ button to search in the other direction.  
The function setting is indicated by "AF ON" or "AF OFF" in the display, indicating that the AF function is on or off, respectively.
- 3 **Switching settings**  
Press either the AM button or FM button.  
The display and setting will change.
- 4 Press the MENU button to end the menu mode.

#### Displaying Frequencies:

Hold down the CLK button for one second or more.  
The frequency for the RDS station will be displayed for five seconds instead of the station name.

#### NOTE

When no other stations with stronger reception are available for the same programme in the RDS network, you may hear the incoming broadcast in bits and snatches. Turn off the AF function in such a case.

### Restricting RDS Region (Region Restrict Function)

You can choose whether or not to restrict the RDS channels, received with the AF function for a particular network, to a specific region. When the Region Restrict Function is on, the region is restricted.

#### Turning Region Restrict Function On/Off:

- 1 Hold down the MENU button for one second or more. "MENU" is displayed and the menu mode is turned on.
- 2 Press the ►► button repeatedly until the Region restrict function appears in the display.  
Press the ◄◄ button to search in the other direction.  
The function setting is indicated by "REG ON" or "REG OFF" in the display, indicating that the function is on or off, respectively.
- 3 **Switching settings**  
Press either the AM button or FM button.  
The display and setting will change.
- 4 Press the MENU button to end the menu mode.

#### NOTE

Sometimes stations in the same network broadcast different programmes or use different programme service names.

### Traffic Information Function

You can listen to traffic information. If you are listening to tapes or discs, they will continue playing until a traffic bulletin is broadcast.

#### Turning TI function On/Off:

Press the TI button to turn the function on and off.  
When the function is on, the TI indicator is turned on.  
When none is being received, the TI indicator will blink on and off. When a traffic information station is being received, the TI indicator will turn on.  
When a traffic bulletin begins to be broadcast, "TRAFFIC" will be displayed, and reception will begin at the preset volume.  
If you are listening to a tape or disc when a traffic bulletin begins, they will automatically be turned off. When the bulletin ends or poor reception is experienced, the tape or disc will begin playing again.

#### NOTE

Pressing the TI button whilst in the MW/LW band automatically

switches reception to the FM band. However, the MW/LW band is not returned to when the TI button is pressed again.

#### **Switching to a Different Traffic Information Station:**

Use the **I◀◀ / ▶▶I** buttons to make an auto seek of the TI stations in a certain band.

##### **NOTE**

- When you are listening to a tape or disc, you cannot change to another TI station.
- When the auto TP seek function is turned on and reception starts to weaken, the tuner automatically seeks traffic information stations with better reception.
- If you are tuned to a station that is not a traffic information station itself but which provides EON services, you can still have traffic information received.
- Holding the TI button down for one second or more when the TI function is on in the disc control mode results in a change to the frequency display of the traffic information station for five seconds.

### **Auto TP Seek Function**

When the TI function is on and poor reception conditions are experienced when listening to a traffic information station, another traffic information station with better reception will be searched for automatically. This function is on, when unit is first powered on.

#### **Turning Auto TP Seek Function On/Off:**

- 1** Hold down the MENU button for one second or more. "MENU" is displayed and the menu mode is turned on.
- 2** Press the **▶▶I** button repeatedly until the Auto TP Seek function appears in the display.  
Press the **I◀◀** button to search in the other direction.  
The function setting is indicated by "ATPS ON" or "ATPS OFF" in the display, indicating that the function is on or off, respectively.

#### **3 Switching settings**

Press either the AM button or FM button.

The display and setting will change.

If the traffic information station you are tuned to experiences poor reception, this function automatically seeks another TP station.

- 4** Press the MENU button to end the menu mode.

### **Presetting Volume for Traffic Information/News**

Preset the volume level to be used for traffic information and news broadcasts.

- 1** Tune into the station for which you want to set the volume.
- 2** Adjust the volume to the desired level.
- 3** Hold down the TI VOL ADJ button for two seconds or more. The volume level blinks once in the display to indicate that the data has been stored.  
Future traffic information/news broadcasts are heard at the preset level.

##### **NOTE**

- The volume cannot be lowered by this function during tuner reception. The volume is only set when it is louder than the listening volume of the tuner.
- You can arrange only to listen to traffic information or news bulletins with at preset volume with the volume set at minimum.

## RDS features

### News Bulletin Function with PTY News Timeout Setting

You can arrange to have news bulletins interrupt your current listening source, including other radio stations. When the News Bulletin function is on, the PTY News Timeout setting allows you to set the interval during which further news interruption cannot take place. You can adjust the PTY news interruption period from 10 to 90 minutes for each journey.

#### Turning News Bulletin Function On/Off:

- 1 Hold down the MENU button for one second or more. "MENU" is displayed and the menu mode is turned on.
- 2 Press the ►► button repeatedly until the News Bulletin function appears in the display. Press the ◀◀ button to search in the other direction. The function setting is indicated by "NEWS OFF" or "NEWS ##M" in the display, indicating that the function is on or off, respectively.

#### NOTE

Depending on the interval chosen, the "##M" in the display will change when the function is turned on.

#### 3 Changing the Function Setting

Press either the FM or AM button. Each time you press the FM or AM button until the desired setting is displayed. Press the FM button to increase the interval, and the AM button to decrease it.

OFF ↔ 00M ↔ 10M ↔ 20M ↔ 30M ↔ 40M ↔ 50M ↔ 60M  
↔ 70M ↔ 80M ↔ 90M (M= minutes)

When you select the news interruption timeout interval, the News function turns on and the NEWS indicator lights up. When a news bulletin is received, "NEWS" will be displayed and reception will begin at the preset volume.

#### NOTE

If you choose the "20M" setting, further news bulletins will not be received for 20 minutes once the first news bulletin is received.

- 4 Press the MENU button to end the menu mode.

#### NOTE

- This function is only available if the desired station sends PTY-code for news bulletin or belongs to EON-Network sending PTY-code for news bulletin.
- If you turn on the news bulletin function in the MW/LW band, the band is switched automatically to the FM band. However, the MW/LW band is not returned to when you turn off the function.

### Programme Type (PTY) Function

Conduct auto seek tuning only on those stations with selected kinds of programmes.

- 1 Press the ►|| (PTY) button. The PTY indicator will turn on, and the Programme Type Selection (PTY) Mode entered. If you make no key input in 30 seconds, the mode will automatically turn off.

#### NOTE

You cannot use this function whilst the traffic information function is turned on.

#### NOTE Changing the Display Language to French, or German.

In the PTY mode, hold down the CLK button for one second or more to display the name of the language currently used. If you want to change the language, press the preset button for the desired language and then the CLK button. English is #1, French is #2, and German is #3.

#### 2 Select the type of programme to be received

- Press either the FM or AM buttons repeatedly until the type of programme you want to listen to. The selection includes:  
Speech (SPEECH) ↔ 1. News (NEWS) ↔ 2. Current Affairs (AFFAIRS) ↔ 3. Information (INFO) ↔ 4. Sports (SPORT) ↔ 5. Education (EDUCATE) ↔ 6. Drama (DRAMA) ↔ 7. Culture (CULTURE) ↔ 8. Science (SCIENCE) ↔ 9. Varied (VARIED) ↔ 10. Pop Music (POP M) ↔ 11. Rock

Music(ROCK M) ↔ 12.Easy Listening Music(EASY M) ↔ 13.Light Classical(LIGHT M) ↔ 14.Serious Classical(CLASSICS) ↔ 15.Other Music(OTHER M) ↔ 16.Weather(WEATHER) ↔ 17.Finance(FINANCE) ↔ 18.Children's programmes(CHILDREN) ↔ 19.Social Affairs(SOCIAL A) ↔ 20.Religion(RELIGION) ↔ 21.Phone In(PHONE IN) ↔ 22.Travel(TRAVEL) ↔ 23.Leisure(LEISURE) ↔ 24.Jazz Music(JAZZ) ↔ 25.Country Music(COUNTRY) ↔ 26.National Music(NATION M) ↔ 27.Oldies Music(OLDIES) ↔ 28.Folk Music(FOLK M) ↔ 29.Documentary(DOCUMENT) ↔ *Music(MUSIC)* ↔ *Speech(SPEECH)* ↔ (*Speech*.....1~9,16~23, 29, *Music*.....10~15, 24~28)

- You can select the type of programme directly by pressing a preset button. The buttons are factory-set to the following type of programmes:

- |                 |                      |           |
|-----------------|----------------------|-----------|
| 1. <i>Music</i> | 2. <i>Speech</i>     | 3. News   |
| 4. Other Music  | 5. Serious Classical | 6. Varied |

**NOTE** Changing the Preset Button Settings for Programme Type

After selecting the type of programme to be stored in a certain preset button, hold down that button for two seconds or more. The previously stored data for that button are erased and the new programme type is stored.

**3 Seeking the selected programme type**

Press the **I◀◀** or **▶▶I** button to make a seek of frequencies with your selected type of programme.

The display blinks and the seek starts.

If your selected type of programme is found, the name of the station is displayed and the station is tuned into.

The PTY indicator blinks in the display for about 30 seconds.

If you make no key input in 30 seconds, the PTY selection mode will turn off automatically.

**NOTE**

If no programme can be found, "NO PTY" is displayed. If you want to select another type of programme, repeat steps 2 and 3 above.

**Switching to Other Stations with the Same Type of Programme:**

When the PTY indicator is blinking in the display, perform auto seek tuning.

The tuner scans for another station with the same type of

programme.

**Cancelling Programme Type Function During Its Operation:**

Press the **▶II(PTY)** button.

## Cassette player features

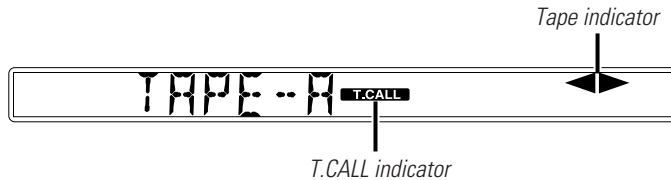
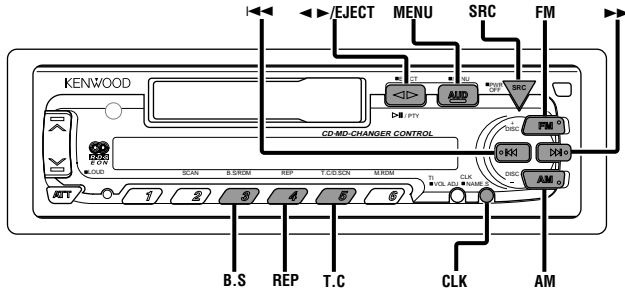

### Playing Cassette Tapes

#### Loading and Playing Cassettes:

Load a cassette with the tape exposed on the right.  
The tape starts playing automatically.

#### Playing Cassettes Already Loaded:

Press the SRC button repeatedly until tape mode is obtained.  
"TAPE" is displayed when the tape mode has been selected.

#### Listening to the other side:

Press the ◀▶ button.  
Tape play switches to the other side.

#### Stopping and Ejecting Cassettes:

Hold down the ◀▶ button for one second or more.  
The tape stops playing and the cassette ejects.

#### NOTE

Remove a cassette from the unit when not listening to it for a whilst. If you leave it in the unit too long, the tape may stick to the tape head and cause the unit to malfunction.

### Fast Forwarding and Rewinding Cassette Tapes

#### Fast Forwarding Tapes:

Press the FM button.

#### Rewinding Tapes:

Press the AM button.

#### Cancelling:

Press the ◀▶ button.  
Normal tape play returns.



## Blank Skip

Automatically fast forwards to the beginning of the next track when long blank spaces (10 seconds or more) are detected, continuing tape playback. This function is on, when unit is first powered on.

### Turning Blank Skip Function On/Off:

Press the B.S button to switch the blank skip function on and off.

"B.S ON" is displayed when the blank skip function is turned on.

#### NOTE

- If the blank space contains hiss noise, the blank skip function may not work correctly.
- Sections recorded at low levels may trigger the blank skip function if they last for 10 seconds or more.

## Tuner Call

Switch automatically to the tuner whilst you are rewinding or fast forwarding the tape.

### Turning Tuner Call Function On/Off:

Press the T.C button to switch the tuner call function on and off.

The T.CALL indicator lights up when the tuner call function is turned on.

## Tape Advance

Rewinds to the beginning of the current track (or fast forwards to the beginning of the next track), continuing tape playback.

### Rewinding tape to the beginning of current track:

Press the I◀ button, and the tape will rewind to the beginning of the current track and automatically start playing again.

### To advance to the beginning of the next track:

Press the ▶I button, and the tape will advance to the beginning of the new track and automatically start playing again.

#### NOTE

The tape advance function "knows" where a track begins by detecting the blank space preceding it (i.e., the space between tracks). However, when the blank space lasts for less than 4 seconds or contains noise, this function may not operate correctly. Furthermore, sections recorded at low levels may trigger the function if they last for 4 seconds or more.

## Music Repeat

Repeatedly plays the current track.

### Turning Music Repeat Function On/Off:

Press the REP button to switch the music repeat function on and off.

"REP ON" is displayed when music repeat is turned on.

### Cancelling Music Repeat Function:

Press either the REP or ◀▶ button.

#### NOTE

The music repeat function "knows" where a track begins by detecting the blank space preceding it (i.e., the space between tracks). However, when the blank space lasts for less than 4 seconds or contains noise, this function may not operate correctly. Furthermore, sections recorded at low levels may trigger the function if they last for 4 seconds or more.

## Cassette player features

### Clock display

#### Switching to the clock display :

Each time you press the CLK button, the display switches between the tape display and clock.

## External disc control features

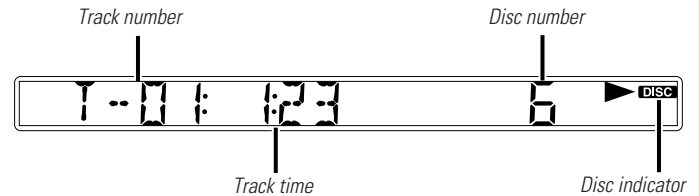
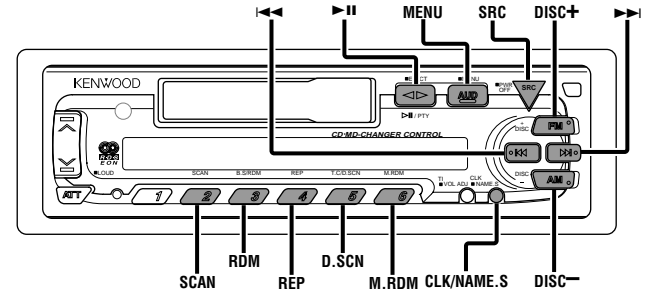

- When a unit equipped with an O-N switch is to be connected, please also see the instruction manual of this unit. Set the O-N switch to "N". "N"-operation will be set.
- When a unit that is not equipped with an O-N switch, or the changer switching unit "KCA-S200" is connected, "O"-operation will be set.

**"N"-operation:**

- The disc title and track title of the CD text can be displayed.
- The disc name will be displayed when the name has been registered to any connected unit with the Presetting Disc Names function, or when the playing unit contains a disc to which the disc title has been recorded.

**"O"-operation:**

- CD text cannot be displayed.
- Regardless of the control unit, the characters that can be registered with the Presetting Disc Names function are "A~Z 0~9 /, +, -, \*, =, <, >, [, ], ".
- The disc name will be displayed when the name has been registered to the playing unit with the Presetting Disc Names function.

**NOTE**

The CD text, Presetting Disc Names, and Disc Name Preset Play functions may not be operational depending on the unit.

## Playing Disc mode

This function permits the connection of optional players and the playing of discs.

**Playing Discs:**

Press the SRC button repeatedly to select the external disc control mode.  
The disc will start playing.

**NOTE**

The external disc control mode will differ, depending on the unit that is connected.  
Mode Display Examples

- "CD"...when a CD player is connected
- "DISC"...when a disc changer is connected
- "DISC-1", "DISC-2"...when two disc changers are connected

**Pausing and Restarting Disc Play:**

Press the ►|| button to make the disc pause.  
Press the same button again to start play again.

**NOTE**

- When one disc has finished playing its last track, the next disc in the changer starts playing. When the last disc in the changer has finished, the player returns to the first disc and starts playing it.
- Disc #10 is displayed as "0".

## Fast Forwarding and Reversing Disc Play

**Fast Forwarding Disc Play:**

Hold down on the ►► button.  
Release your finger to play the disc at that point.

**Reversing Disc Play:**

Hold down on the ◀◀ button.  
Release your finger to play the disc at the point.

**NOTE**

You cannot use reverse play between tracks depending on the model being connected. Instead, the reverse play function is cancelled when it reaches the beginning of a track, at which point normal play automatically resumes.

## External disc control features

### Track Search

Search forwards or backwards through the tracks on the disc until you reach the one that you want to listen to.

#### Making a Reverse Track Search:

Press the ◀◀ button to display the desired track number.

Press once to search back to the beginning of the current track, twice to search back to the beginning of the previous track, and so forth.

Play starts at the beginning of the displayed track number.

**NOTE** (For disc changers)

Pressing the ◀◀ button whilst listening to track 1 only searches back to the beginning of that track. The reverse search is not "recycled" to the last track on the disc.

#### Making a Forward Track Search:

Press the ▶▶ button to display the desired track number.

Press once to fast forward to the next track, twice to fast forward to the track after that, and so forth.

Play starts at the beginning of the displayed track number.

**NOTE** (For disc changers)

You cannot make a forward track search when listening to the last track on a disc.

### Disc Search *(Function of disc changers)*

Search forwards or backwards through the discs in a disc changer until you reach the one that you want to listen to.

#### Making a Reverse Disc Search:

Press the DISC- button to display the desired disc number.

Each time the button is pressed, the displayed disc number decreases by one.

Play starts at the beginning of the displayed disc.

#### Making a Forward Disc Search:

Press the DISC+ button to display the desired disc number.

Each time the button is pressed, the displayed disc number increases by one.

Play starts at the beginning of the displayed disc.

**NOTE**

"LOAD" is displayed when discs are being exchanged on the disc changer.

### Track / Disc Repeat

Repeat playing the current track or disc.

#### Turning Repeat Play Function On/Off:

Press the REP button to switch the repeat play function on and off as follows :

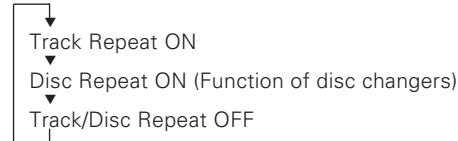

"TREP ON" is displayed and the track number blinks in the display when track repeat is on.

"DREP ON" is displayed and the disc number blinks in the display when disc repeat is on.

**NOTE**

The repeat play function is cancelled when you stop playing the disc.

### Track Scan

Successively play the beginning of each track on a disc until you find the track that you want to listen to.

#### Starting the Track Scan :

Press the SCAN button. "TSCN ON" is displayed and the first 10 seconds of each track are played, and the tracks are played in order.

The track number currently being heard blinks in the display.

**Stopping to Listen to the Track Being Scanned:**

Press the ►|| or SCAN button again to stop the scan and keep on listening to a track normally.

**NOTE**

- The track scan function is cancelled when you stop playing a disc.
- The track scan function only scans each track on a disc once.

**Disc Scan**

*(Function of disc changers)*

Successively play the beginning of each disc on a changer until you find the one that you want to listen to.

**Starting the disc scan:**

Press the D.SCN button. "DSCN ON" is displayed and the first 10 seconds of each disc are played, in the order in which they are loaded on the changer.

The disc number currently being heard blinks in the display.

**Stopping to Listen to the Disc Being Scanned:**

Press the ►|| or D.SCN button again to stop the scan and keep on listening to the disc normally.

**NOTE**

- The disc scan function is cancelled when you stop playing a disc.
- The disc scan function only scans each disc on the changer once.
- "LOAD" is displayed when discs are being exchanged on the disc changer.

**Random Play**

Play all the tracks on the current disc in random order.

- 1 Press the RDM button to switch the random play function on

and off.

"RDM ON" is displayed when random play is turned on.

The display of the track number changes continuously as the next track is being selected.

When the track has been selected, play starts.

The selected track number blinks in the display as it is being played.

**NOTE**

When all the tracks on a certain disc have been played using the random play function, the next disc on the changer starts playing (with the random play function still turned on).

- 2 To change the track being heard, press the ►► button. Another track is selected and played.

**NOTE**

The random play function is cancelled when you stop playing a disc.

## External disc control features

### Magazine Random Play *(Function of disc changers)*

Play the tracks on all the discs in the disc changer in random order.

- 1 Press the M.RDM button to switch the magazine random play function on and off.  
"MRDM ON" is displayed when magazine random play is turned on.  
The display of the disc and track numbers change continuously as the next track is being selected.  
When the disc/track has been selected, play starts.  
The selected disc/track number blinks in the display as it is being played.

#### NOTE

This function is not available with the following models:  
KDC-C200/C300/C400/C301/C401

- 2 To change the track being heard, press the ►► button.  
Another disc/track is selected and played.

#### NOTE

- The magazine random play function is cancelled when you stop playing a disc.
- The time needed for random selection depends on the number of discs loaded in the disc magazine.

### Presetting Disc Names

Store the names of discs to be displayed when played.

- 1 Play the disc whose name you want to preset.

#### NOTE

- This function is not available for disc changers that do not feature the Disc Name Preset function.
  - This procedure is not to be used to store the disc and track titles for MDs that you record.
- 2 Hold down the NAME.S button for two seconds or more.  
"NAME SET" is displayed and the disc name preset mode is

entered.

The cursor blinks in the position where character input can be made.

- 3 Press either the ◀◀ or ▶▶ button to move the cursor to the desired position.  
The ◀◀ button moves the cursor to the left, and the ▶▶ button to the right.  
You can also move the cursor left or right by pressing the TRACK+ or TRACK- buttons, respectively, on the remote control.
- 4 Press the DISC+ or DISC- button to display the desired character.

#### NOTE

The operation and characters that can be entered may change as listed below, depending on the unit that is connected.  
Press the DISC+ or DISC- button to display the desired character.

Besides the alphabet (capital letters only) and numerals, you can choose the following characters: /, +, -, \*, =, <, >, [ and ]

- 5 Continue steps 3 and 4 until all the characters are chosen for the name.

#### NOTE

You can enter up to 8 characters for each name.

- 6 Press either the NAME.S button on the main unit or the OK button on the remote control.

The disc name is stored and the disc name preset mode is cancelled.

If you make no entry in a 10-second period, the name will be stored with the characters entered so far.

#### NOTE

- The number of discs whose names can be stored will differ depending on the disc changer that is connected. Please see your disc changer manual for details.
- Discs are identified by their total length and number of tracks. If you play another CD that happens to have exactly the same specifications as another CD whose name is stored, the wrong name will be displayed for it.

- If you want to change the name of a disc, repeat steps 1 and 2 to display the name, and then repeat steps 3 and 4 to enter the changes.
- Pressing the reset button does not erase the disc names stored in a disc changer.

#### *Function of the KRC-477R/KRC-477RV*

### **Disc Name Preset Play (DNPP)**

#### *Function of remote control with DNPP button*

If you have preset the name of a disc that you want to listen to in the disc changer, you can look for it by name and start playing it.

- 1 Press the DNPP button on the remote control. "DNPP" will appear in the display, and the disc name preset play mode is entered. The names of all the discs in the disc changer will appear successively in the display for five seconds each. Discs whose names have not been preset will appear as "NO NAME" in the display.

#### **NOTE**

- This function can only be used in disc changers that were manufactured or sold as of 1997. Also note that some units cannot provide a display unless the disc name preset has been made by the unit that is playing.
- Discs in the disc changer that have never been played before will appear as "NO ACCES" when the disc names are displayed. When you cannot identify a disc because of the "NO ACCES"

display after inserting a disc magazine, try playing it using the disc scan or a similar function to display the disc name. Also note that "NO DISC" will be displayed when a disc has not been loaded.

#### **Rapid display (forward / reverse):**

Press the DISC+ or DISC- button.

Pressing the DISC+ button will rapidly display the preset names/disc titles in order.

Pressing the DISC- button will rapidly display the preset names/disc titles in reverse order.

#### **2 When the name appears for the disc you want to play**

Press the OK button.

The disc whose name is displayed will be recalled, and the disc name preset play (DNPP) mode will end.

#### **To cancel DNPP mode:**

Press the DNPP button.

The disc name preset play (DNPP) mode will be cancelled.

## External disc control features

### Text / Title Scroll

This function permits the text to be scrolled and the entire text to be displayed. Switching between manual scrolling and automatic scrolling is permitted. The factory default is manual scrolling.

#### To scroll manually:

- 1 Press the DISP button to display the disc title or the track title.
- 2 Holding down the DISP button for one second or more results in one scrolling display of the titles.

#### Manual/Automatic scroll switching:

- 1 Hold down the MENU button for one second or more. "MENU" is displayed and the menu mode is turned on.
- 2 Press the ►► button repeatedly until the Text/title scroll function appears in the display. Pressing the ◄◄ button results in the functions being switched in the reverse order. The text/title scroll function is displayed with "SCL Auto" or "SCL Manu".  
"SCL Manu" (Manual scrolling)  
"SCL Auto" (Automatic scrolling)

#### 3 Switching settings

Press either the AM or FM button.  
The display and setting will change.

- 4 Press the MENU button to end the menu mode.

#### To scroll automatically:

- 1 Press the DISP button to display the disc title or the track title. The titles will be displayed in one scrolling display.

#### NOTE

When the disc or track to be played changes, the title is displayed in one scrolling display.

- 2 Holding down the DISP button for one second or more results in one scrolling display of the titles.

#### NOTE

- Only units with a CD text feature permit title display.
- This function is not supported for MD changers.

### Switching Display for Discs

Switch the display that appears whilst discs are playing.

#### Switching Display for Discs:

Each time you press the DISP button, the display during disc play switches as follows.

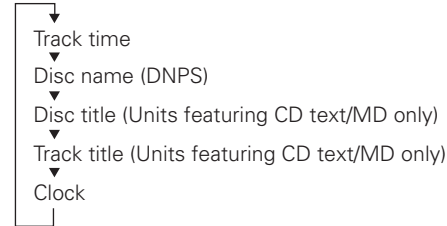

#### NOTE

- You can give names to discs through the presetting disc name function (see p. 22). Note that depending on the unit, display may not be possible.
- If you try to display the name of a disc that does not have one, "NO NAME" is displayed instead.
- When there is an attempt to display the title of a disc for which the disc title/track title has not been recorded, "NO TEXT" is displayed for CD and "NO NAME" is displayed for MD.
- Depending on the type of characters of the CD Text, some characters may not be displayable.





## Other features

### Audio Control Setting

Adjust various parameters of sound quality.

- 1 Press the AUD button to enter the control mode.
- 2 Press either the FM or AM button.  
Each time the button is pressed, the adjustment mode will change as follows:  
Pressing the FM button advances the display, and pressing the AM button reverses it.



#### NOTE Source tone memory

Each source (tape, FM, AM, and disc changer) has its own memory in which to store the bass and treble tone settings. The settings made for a particular source are then recalled automatically whenever you use that source (e.g., FM mode uses the tone settings made for FM, AM for AM, etc.).

- 3 Press the ◀◀/▶▶ button.  
Look at the table to adjust the mode being displayed.

Adjustment mode (Display)	Operation of Audio control button	
	◀◀ button	▶▶ button
Bass ("BAS")	Bass decreased.	Bass increased.
Treble ("TRE")	Treble decreased.	Treble increased.
Balance ("BAL")	Left channel emphasized.	Right channel emphasized.
Fader ("FAD")	Rear channel increased.	Front channel increased.

- 4 Press the AUD button to end the control mode.

### Adjusting Time

With automatic time adjustment, you can set the clock time automatically according to time data sent from RDS stations (after receiving RDS signals for several minutes). You can also set the time manually if the automatic time adjustment function is turned off. The factory default is automatic time adjustment.

#### Adjusting Time Automatically:

Tune into an RDS station for 3 or 4 minutes.

The time adjusts automatically to the correct local time.

#### NOTE

The time is not adjusted when the RDS station you are tuned to is not transmitting a time signal. Choose another RDS station in such a case.

#### Turning Automatic Time Adjustment On/Off:

- 1 Hold down the MENU button for one second or more.  
"MENU" is displayed and the menu mode is turned on.
- 2 Press the ▶▶ button repeatedly until the Automatic Time Adjustment function appears in the display.  
Press the ◀◀ button to search in the other direction.  
The function setting is indicated by "SYNC ON" or "SYNC OFF" in the display, indicating that the Automatic Time Adjustment is on or off, respectively.  
"SYNC ON" (Automatic time adjustment)  
"SYNC OFF" (Manual time adjustment)
- 3 **Switching settings**  
Press either the AM button or FM button.  
The display and setting will change.
- 4 Press the MENU button to end the menu mode.

#### Adjusting Time Manually:

- 1 Turn off the Automatic Time Adjustment as mentioned above.
- 2 Hold down the MENU button for one second or more.  
"MENU" is displayed and the menu mode is turned on.
- 3 Press the ▶▶ button repeatedly until the "CLK ADJ" appears in the display.  
Press the ◀◀ button to search in the other direction.

- 4 Hold down either the AM or FM button for two seconds or more to enter the Time Adjustment mode. The time display will blink.
- 5
  - Adjusting the hours  
Press the FM button to advance the hours, or press the AM button to make the hours go back.
  - Adjusting the minutes  
Press the ►► button to advance the minutes, or press the ◀◀ button to make the minutes go back.
- 6 Press the MENU button to end the menu mode.

### TEL Mute

Shut down the audio system temporarily whenever an incoming call is received.

#### NOTE

The function will not work if a cable is not connected to the car phone.

#### **When the telephone rings:**

When a call is received, "CALL" is displayed and all the unit functions are temporarily interrupted.

#### **Restoring Original Unit Source During Phone Call:**

Press the SRC button.

"CALL" disappears from the display, and the volume of the original source is restored gradually.

#### **Turning TEL Mute Function Off After Phone Call:**

Hang the phone up.

"CALL" disappears from the display.

The original source (i.e., the one used before the phone call) is returned to automatically, and the volume restored gradually.

### Touch Sensor Tone

This function produces a beep sound that accompanies button operation. It can be switched on or off.

#### **Turning the Beep On/Off:**

- 1 Hold down the MENU button for one second or more. "MENU" is displayed and the menu mode is turned on.
- 2 Press the ►► button repeatedly until the Touch Sensor Tone function appears in the display.  
Press the ◀◀ button to search in the other direction.  
The function setting is indicated by "BEEP ON" or "BEEP OFF" in the display, indicating that the current beep setting is on or off, respectively.
- 3 **Switching settings**  
Press either the AM or FM button.  
The display and setting will change.
- 4 Press the MENU button to end the menu mode.

#### NOTE

The beep sound is not output from the preout jacks.

### Navigation Mute Function

When the KENWOOD Navigation System is connected, an interruption of the audio guide results in the temporary lowering of the audio level.

#### NOTE

The Navigation mute function cannot be used unless a TEL mute cable is connected to the KENWOOD Navigation System.

## Other features

### Disabled System Indicator (DSI)

A red indicator blinks on the unit after the faceplate is removed, warning potential thieves. The factory default for this function is "ON".

#### Turning Disabled System Indicator On/Off:

- 1 Hold down the MENU button for one second or more. "MENU" is displayed and the menu mode is turned on.
- 2 Press the ►► button repeatedly until the Disabled System Indicator function appears in the display. Press the ◄◄ button to search in the other direction. The function setting is indicated by "DSI ON" or "DSI OFF" in the display, indicating that the disable system indicator is on or off, respectively.
- 3 **Switching settings**  
Press either the AM button or FM button. The display and setting will change.
- 4 Press the MENU button to end the menu mode.

### Theft Deterrent Faceplate

The faceplate of the unit can be detached and taken with you, helping to deter theft.

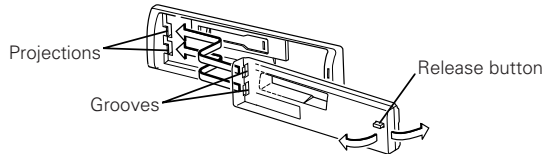

#### Removing Faceplate:

Press the release button.  
The faceplate is unlocked, allowing you to detach it.

#### NOTE

- The faceplate is a precision piece of equipment and can be damaged by shocks or jolts. For that reason, keep the faceplate

in its special storage case whilst detached.

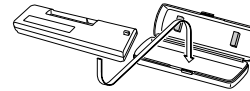

- Do not expose the faceplate or its storage case to direct sunlight or excessive heat or humidity. Also avoid places with too much dust or the possibility of water splashing.

#### Reattaching Faceplate:

- 1 Align the projections on the unit with the grooves on the faceplate.
- 2 Push the faceplate in until it clicks. The faceplate is locked in place, allowing you to use the unit.

## Accessories

### External view

	Number of items
① 	.....1 KRC-477R/377R/32R only
② 	.....2
③ 	.....1

### ▲CAUTION

The use of any accessories except for those provided might result in damage to the unit. Make sure only to use the accessories shipped with the unit, as shown above.

## Installation Procedure

1. To prevent short circuits, remove the key from the ignition and disconnect the ⊖ terminal of the battery.
2. Make the proper input and output cable connections for each unit.
3. Connect the cable on the wiring harness.
4. Take Connector B on the wiring harness and connect it to the speaker connector in your vehicle.
5. Take Connector A on the wiring harness and connect it to the external power connector on your vehicle.
6. Connect the wiring harness connector to the unit.
7. Install the unit in your car.
8. Reconnect the ⊖ terminal of the battery.
9. Press the reset button.

### ▲CAUTION

- If your car is not prepared for this special connection-system, consult your Kenwood dealer.
- Only use antenna conversion adapters (ISO-JASO) when the antenna cord has an ISO plug.
- Make sure that all cable connections are securely made by inserting jacks until they lock completely.
- If your vehicle's ignition does not have an ACC position, or if the ignition cable is connected to a power source with constant voltage such as a battery cable, the power will not be linked with the ignition (i.e., it will not turn on and off along with the ignition). If you want to link the unit's power with the ignition, connect the ignition cable to a power source that can be turned on and off with the ignition key.
- If the fuse blows, first make sure that the cables have not caused a short circuit, then replace the old fuse with one with the same rating.
- Do not let unconnected cables or terminals touch metal on the car or anything else conducting electricity. To prevent short circuits, also do not remove the caps on the ends of the unconnected cables or the terminals.
- Connect the speaker cables correctly to the terminals to which they correspond. The unit may receive damage or fail to work if you share the ⊖ cables and/or ground them to any metal part in the car.
- After the unit is installed, check whether the brake lamps, indicators, wipers, etc. on the car are working properly.
- Insulate unconnected cables with vinyl tape or other similar material.
- Some disc changers need conversion cables for connection. See the section on "Safety Precautions" for details.
- If the console has a lid, make sure to install the unit so that the faceplate does not hit the lid when closing and opening.

## Connecting Cables to Terminals

### ■ ISO connector unsupported car (KRC-477R/377R/32R only)

#### ⚠ CAUTION

When only two speakers are being connected to the system, connect the connectors either to both the front output terminals or to both the rear output terminals (do not mix front and rear). For example, if you connect the ⊕ connector of the left speaker to a front output terminal, do not connect the ⊖ connector to a rear output terminal.

#### ⚠ WARNING

If you connect the ignition cable (red) and the battery cable (yellow) to the car chassis (ground), you may cause a short circuit, that in turn may start a fire. Always connect those cables to the power source running through the fuse box.

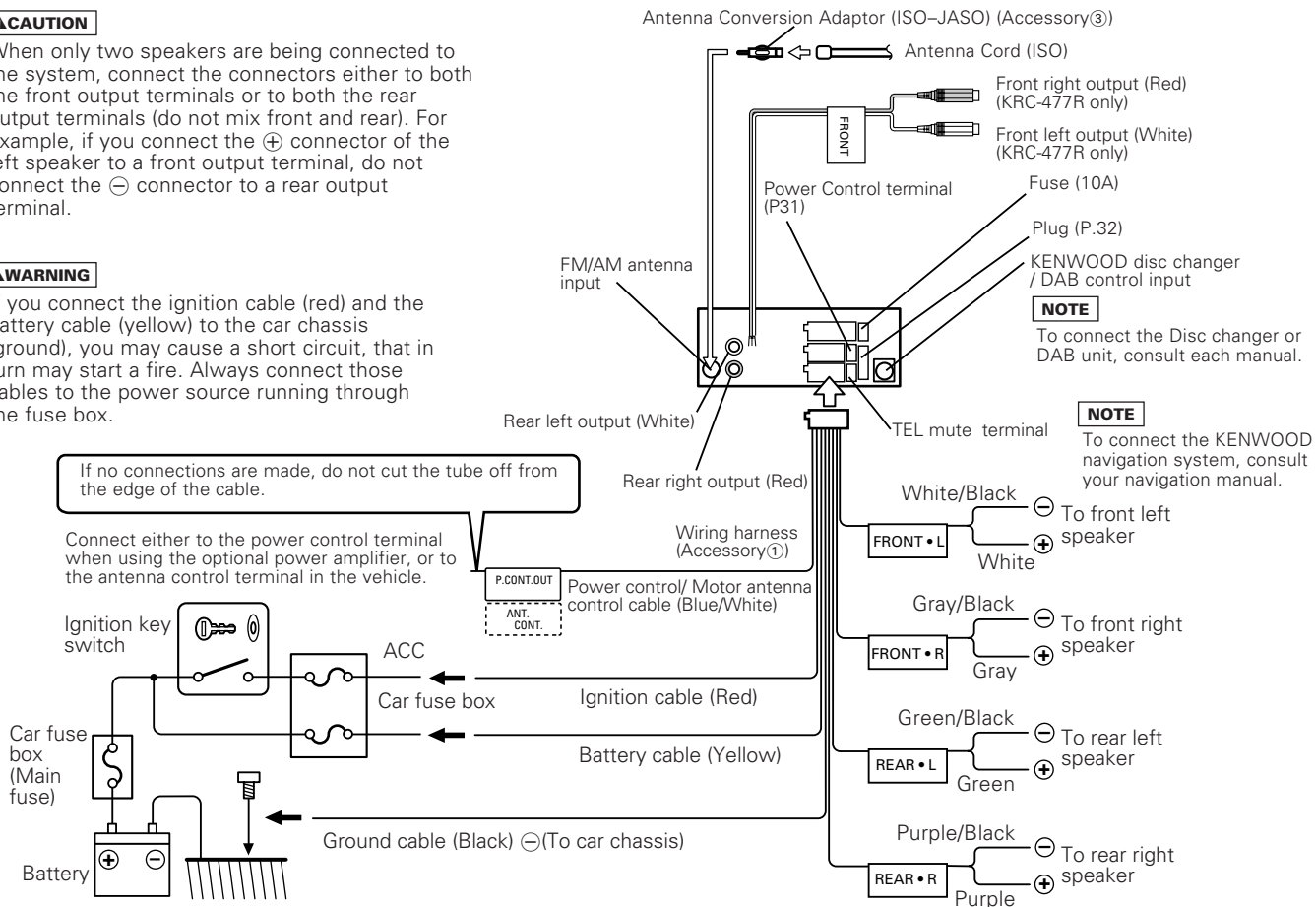

## ■ ISO connector supported car

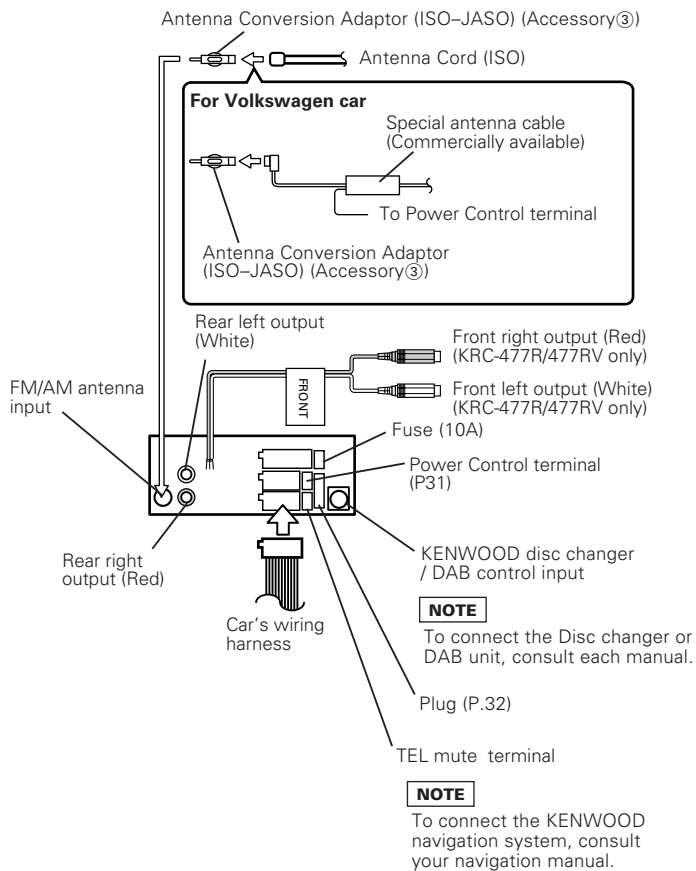

## ■ Power Control Terminal Connections

The output of the Power Control terminal is switched along with the power on/off switching of the unit. This terminal can be connected to the P.CON (REMOTE) terminal of the amplifier, or used as the power supply of the special antenna cable for Volkswagen cars. (MAX. 400 mA)

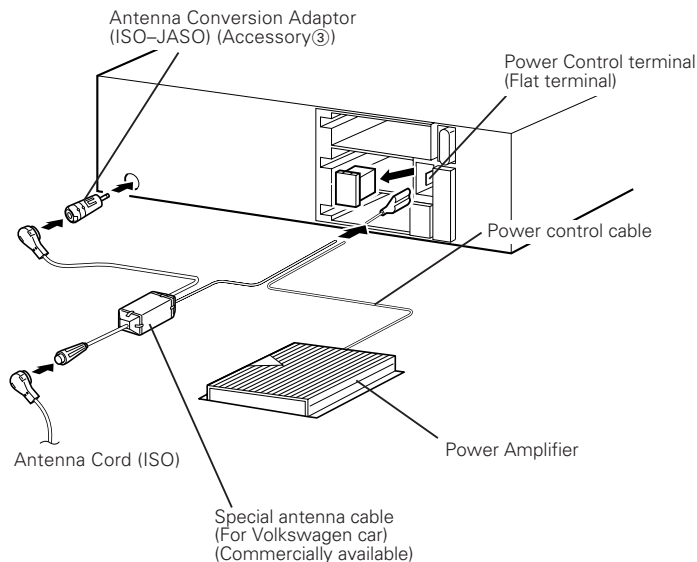

## ■ Connector Function Guide

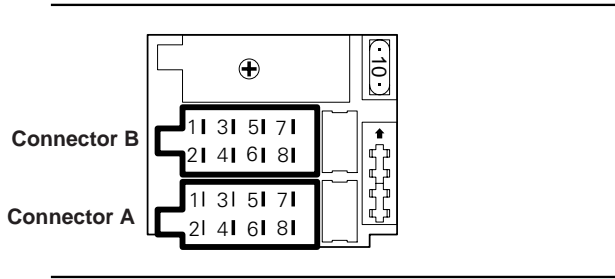

Pin Numbers for ISO Connectors	*Plug setting	Cable Colour	Functions
External Power Connector			
A-4	1	Yellow	Battery
	2	Red	Ignition (ACC)
A-5		Blue/White	Power Control
A-7	1	Red	Ignition (ACC)
	2	Yellow	Battery
A-8		Black	Earth (Ground) Connection
Speaker Connector			
B-1		Purple	Rear Right (+)
B-2		Purple/Black	Rear Right (-)
B-3		Gray	Front Right (+)
B-4		Gray/Black	Front Right (-)
B-5		White	Front Left (+)
B-6		White/Black	Front Left (-)
B-7		Green	Rear Left (+)
B-8		Green/Black	Rear Left (-)

\*Plug setting: See right side.

## ■ Plug Setting

### ⚠WARNING Connecting the ISO Connector

The pin arrangement for the ISO connectors depends on the type of vehicle you drive. Make sure to make the proper connections to prevent damage to the unit.

- 1 The A-7 pin (red) of the vehicle's ISO connector is linked with the ignition, and the A-4 pin (yellow) is connected to the constant power supply. (Default setting; KRC-477R/377R/32R)

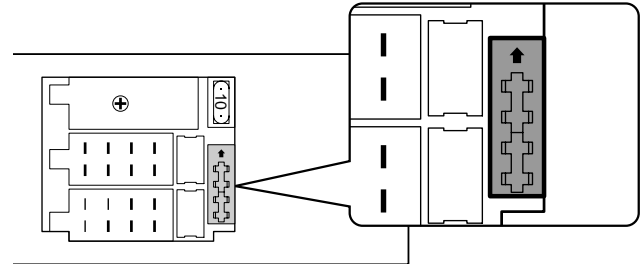

- 2 The A-7 pin (red) of the vehicle's ISO connector is connected to the constant power supply, and the A-4 pin (yellow) is linked to the ignition. (Default setting; KRC-477RV)

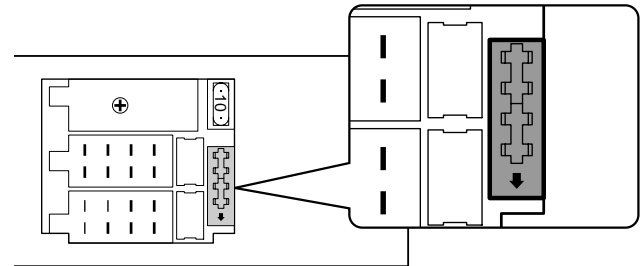



# Installation

## ■ Installation

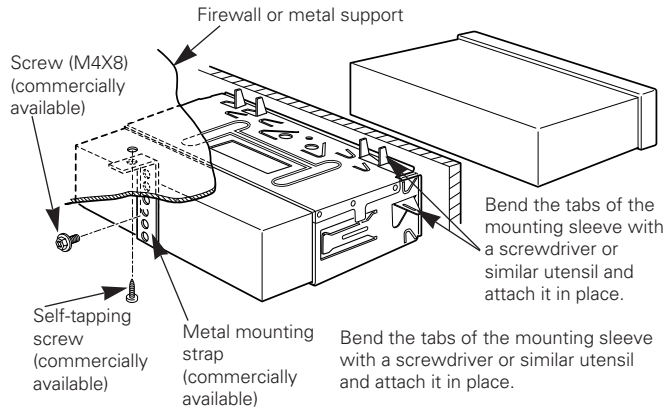

### NOTE

Make sure that the unit is installed securely in place. If the unit is unstable, it may malfunction (eg, the sound may skip).

## ■ Removing the hard rubber frame

- 1 Engage the catch pins on the removal tool and remove the two locks on the lower level.  
Lower the frame and pull it forward as shown in the figure.

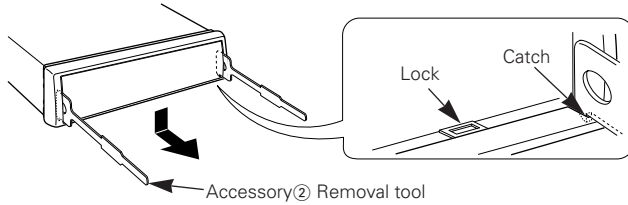

- 2 When the lower level is removed, remove the upper two locations.

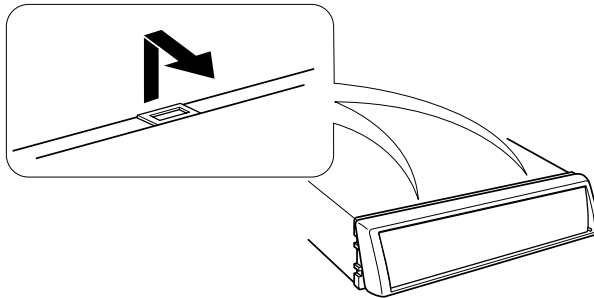

### NOTE

The frame can be removed from the top side in the same manner.

## ■ Removing the Unit

- 1 Refer to the section "Removing the hard rubber frame" and then remove the hard rubber frame.
- 2 Remove the screw (M4x8) on the back panel.
- 3 Insert the two removal tools deeply into the slots on each side, as shown.

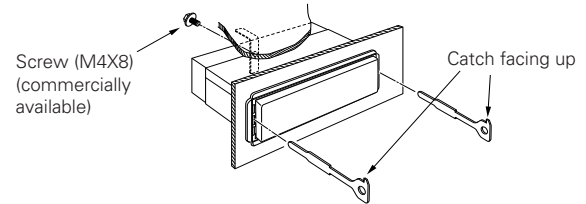

- 4 Lower the removal tool toward the bottom, and pull out the unit halfway whilst pressing towards the inside.

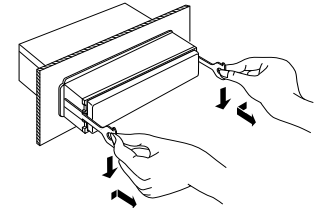

### CAUTION

Be careful to avoid injury from the catch pins on the removal tool.

- 5 Pull the unit all the way out with your hands, being careful not to drop it.

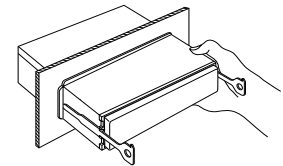

## Troubleshooting Guide

What might appear to be a malfunction in your unit may just be the result of slight misoperation or miswiring. Before calling service, first check the following table for possible problems.

PROBLEM	POSSIBLE CAUSE	SOLUTION
The power does not turn on.	The fuse has blown.	After checking for short circuits in the cables, replace the fuse with one having the same rating.
	No ACC position on vehicle ignition.	Connect the same cable to the ignition as the battery cable.
No sound can be heard, or the volume is low.	The Attenuator function is turned on.	Turn off the Attenuator function.
	The fader and/or balance settings are set all the way to one side.	Reset the fader and/or balance settings.
	The input/output cables or wiring harness are connected incorrectly.	Reconnect the input/output cables and/or the wiring harness correctly. See the section on "Connecting Cables to Terminals".
	The cassette tape is bad.	Try playing another cassette tape. If no problem is experienced, the first tape was bad.
The tape does not go in. / No sound can be heard even though the tape display is made.	The car ignition was turned off during tape eject; or the tape was pulled out during loading, switching the mode to tape mode even though no tape is in.	Press the Eject button.
Nothing happens when the buttons are pressed.	The computer chip in the unit is not functioning normally.	Press the reset button on the unit (see page 4).
The sound quality is poor or distorted.	The tape head is dirty.	Clean the tape head, referring to the section on "Cleaning the tape head" (see page 4).
	A speaker cable may be pinched by a screw in the car.	Check the speaker wiring.
	The speakers are not wired correctly.	Reconnect the speaker cables so that each output terminal is connected to a different speaker.
Radio reception is poor.	The car antenna is not extended.	Pull out the antenna all the way.
	The antenna control cable is not connected.	Connect the cable correctly, referring to the section on "Connecting Cables to Terminals".

PROBLEM	POSSIBLE CAUSE	SOLUTION
The memory is erased when the ignition is turned off.	The battery cable has not been connected to the proper terminal.	Connect the cable correctly, referring to the section on "Connecting Cables to Terminals".
	The ignition and battery cable are incorrectly connected.	Connect the cable correctly, referring to the section on "Connecting Cables to Terminals".
The TEL mute function does not work.	The TEL mute cable is not connected properly.	Connect the cable correctly, referring to the section on "Connecting Cables to Terminals".
The TEL mute function turns on even though the TEL mute cable is not connected.	The TEL mute cable is touching a metal part of the car.	Pull the TEL mute cable away from the metal part of the car.

## External disc control mode

PROBLEM	POSSIBLE CAUSE	SOLUTION
The disc control mode cannot be selected.	No cable has been connected to the disc changer input terminal on the unit.	Connect the cable to the disc changer input terminal on the unit.
The specified disc does not play, but another one plays instead.	The specified CD is very dirty.	Clean the CD.
	The CD is upside-down.	Load the CD with the labelled side up.
	The disc is loaded in a different slot from that specified.	Eject the disc magazine and check the number for the specified disc.
	The disc is severely scratched.	Try another disc instead.
The sound skips.	Something is touching the disc changer.	Remove whatever is touching it.
	The CD is scratched or dirty.	If skipping happens at the same place when the car is stopped, something is wrong with the CD. Clean the CD.
The display shows that the changer is being played, but no sound can be heard.	The computer chip in the unit is not functioning normally.	Press the reset button on the unit (see page 4).
The specified track does not play.	Random play or magazine random play has been selected.	Turn off the random play or magazine random play function.

### If the following situations, consult your nearest service centre:

- Even though the disc changer is connected, the Disc Changer Mode is not on, with "AUX" showing in the display during the Changer Mode.
- Even though no device (KCA-S210A, CA-C1AX, KDC-CPS82 or KDC-CX82) is connected, the AUX Mode is entered when switching modes.

## Troubleshooting Guide

The following messages are displayed when certain problems are occurring in your system. Take the recommended actions.

- EJECT No disc magazine has been loaded in the changer. The disc magazine is not completely loaded.  
⇒ Load the disc magazine properly.  
No CD in the unit.  
⇒ Insert the CD.
- NO DISC No disc has been loaded in the disc magazine.  
⇒ Load a disc into the disc magazine.
- E-04 No disc has been loaded in the disc magazine.  
⇒ Load a disc into the disc magazine.  
The CD is very dirty. The CD is upside-down. The CD is scratched a lot.  
⇒ Clean the CD and load it correctly.
- BLANK Nothing has been recorded on the MD.  
⇒ The next MD is automatically played back
- NO TRACK No tracks are recorded on the MD, although it has a title.  
⇒ The next MD is automatically played back.
- NO PANEL The faceplate of the slave unit being connected to this unit has been removed.  
⇒ Replace it.
- E-77 The unit is malfunctioning for some reason.  
⇒ Press the reset button on the unit. If the "E- 77", code does not disappear, consult your nearest service centre.
- E-99 Something is wrong with the disc magazine. Or the unit is malfunctioning for some reason.  
⇒ Check the disc magazine. And then, press the reset button on the unit.  
If the "E- 99" code does not disappear, consult your nearest service center.
- HOLD The protective circuit in the unit activates when the temperature inside the automatic disc changer exceeds 60°C (140°F), stopping all operation.  
⇒ Cool down the unit by opening the windows or turning on the air conditioner. As the temperature falls below 60°C (140°F), the disc starts playing again.
- ◀▶ If this indicator continues blinking, it is possible that the tape has become jammed or tangled.  
⇒ Contact the Kenwood dealer if the tape cassette cannot be ejected.

## Specifications

Specifications subject to change without notice.

### FM tuner section

Frequency range (50 kHz Space).....	87.5 MHz – 108.0 MHz
Usable sensitivity (S/N = 26dB).....	0.7 $\mu$ V/75 $\Omega$
Quieting Sensitivity (S/N = 46dB).....	1.6 $\mu$ V/75 $\Omega$
Frequency response ( $\pm$ 3.0 dB).....	30 Hz – 15 kHz
Signal to Noise ratio (MONO).....	65 dB
Selectivity (DIN) ( $\pm$ 400 kHz).....	$\geq$ 80 dB
Stereo separation (1 kHz).....	35 dB

### MW tuner section

Frequency range (9 kHz Space).....	531 kHz – 1611 kHz
Usable sensitivity (S/N = 20dB).....	25 $\mu$ V

### LW tuner section

Frequency range.....	153 kHz – 281 kHz
Usable sensitivity (S/N = 20dB).....	45 $\mu$ V

### Cassette player section

Tape speed.....	4.76 cm/sec.
Wow & Flutter (WRMS).....	0.08 %
Frequency response(120 $\mu$ s).....	30 Hz – 14 kHz ( $\pm$ 3 dB)
Separation (1 kHz).....	43 dB
Signal to Noise ratio.....	54 dB

### Audio section

Maximum output power	
KRC-477R/477RV.....	40 W $\times$ 4
KRC-377R/32R.....	35 W $\times$ 4
Output power (DIN 45324, +B=14.4 V)	
KRC-477R/477RV.....	26 W $\times$ 4
KRC-377R/32R.....	21 W $\times$ 4
Tone action	
Bass:.....	100 Hz $\pm$ 10 dB
Treble:.....	10 kHz $\pm$ 10 dB
Preout level / load.....	1800 mV / 10 k $\Omega$
Preout Impedance.....	$\leq$ 600 $\Omega$

### General

Operating voltage.....	14.4 V (11 – 16 V allowable)
Current consumption.....	10 A
Installation size (W $\times$ H $\times$ D).....	182 $\times$ 53 $\times$ 158 mm
Weight.....	1400 g



KENWOOD



## Free Manuals Download Website

<http://myh66.com>

<http://usermanuals.us>

<http://www.somanuals.com>

<http://www.4manuals.cc>

<http://www.manual-lib.com>

<http://www.404manual.com>

<http://www.luxmanual.com>

<http://aubethermostatmanual.com>

Golf course search by state

<http://golfingnear.com>

Email search by domain

<http://emailbydomain.com>

Auto manuals search

<http://auto.somanuals.com>

TV manuals search

<http://tv.somanuals.com>