

KENWOOD

HI-FI COLOR TV/MONITOR

KMT-5032

INSTRUCTION MANUAL

KENWOOD CORPORATION

KENWOOD

KENWOOD

KENWOOD

ADJUSTING PICTURE/
AUDIO FUNCTIONS 30

CHANNEL
PROGRAMMING 20

OPERATION 18

MENU FUNCTION 16

LOCATION OF
CONTROLS 8

Thank you for purchasing a KENWOOD Hi-Fi Color TV/Monitor.
 Read this guidebook so you will be able to enjoy all the features in your TV set.
 Record in space provided below the Model No. as found on the label on the back of your TV set.

Model No. _____ Serial No. _____

Retain this information for future reference.

TABLE OF CONTENTS

Safety precautions	2
Installing your set.....	3
Antenna/Cable TV connection	3-7
Home antenna connection	5
Cable TV connection	6
Antenna/Cable TV and VCR connections	7
Location of controls	8-10
Using the Remote Control Unit	11-15
Menu function	16-17
Operation	18-19
Channel programming.....	20-21
Locking channels for parental control	22
Channel captioning	23
Setting the clock.....	24
Setting the off-timer (sleep)	25
Receiving Stereo/SAP broadcasts.....	26-27
Selecting picture preference feature.....	28
Operating noise reduction feature.....	29
Adjusting picture functions	30-31
Adjusting audio functions.....	32
Selecting language for on-screen message	33
Enjoying Picture In Picture (PIP) feature	34-37
Connecting optional equipment	38-43
Using the audio/video input jacks	38
Using the S-video/audio input jacks	39
Using the audio/video output jacks	40
Using the variable audio output jacks	41
Dubbing/editing programs with 2 VCRs	42
Connecting external speakers	43
Cleaning and care	44
Specifications	44
Before calling service personnel	45

SAFETY PRECAUTIONS

WARNING: TO REDUCE THE RISK OF FIRE OR ELECTRIC SHOCK, DO NOT EXPOSE THIS APPLIANCE TO RAIN OR MOISTURE.

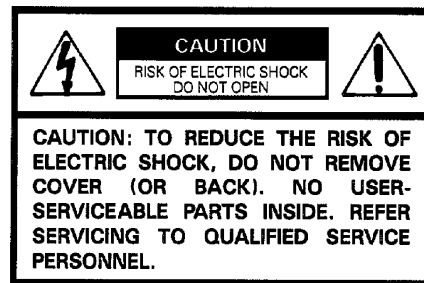

The lightning symbol in the triangle tells you that the voltage inside this product may be strong enough to cause an electric shock. DO NOT TRY TO SERVICE THIS PRODUCT YOURSELF.



The exclamation point in the triangle tells you that important operating and maintenance instructions follow this symbol.

CAUTION: TO PREVENT ELECTRIC SHOCK, DO NOT USE THIS POLARIZED PLUG WITH AN EXTENSION CORD RECEPTACLE OR OTHER OUTLET UNLESS THE PRONGS CAN BE FULLY INSERTED INTO THE OUTLET TO PREVENT ANY EXPOSURE OF THE PRONGS ON THE POLARIZED PLUG.

NOTE TO CATV SYSTEM INSTALLER:

This reminder is provided to call the CATV system installer's attention to Article 820-22 of the NEC that provides guidelines for proper grounding and, in particular, specifies that the cable ground shall be connected to the grounding system of the building, as close to the point of cable entry as practical.

INSTALLING YOUR SET

WARNING: Do not place the TV on an uneven floor or on an unstable stand. The set may overturn, causing serious injury to you or your children. Take care that your children do not get on the TV or hang on to it.

DO NOT:

- Place your TV set in a room where direct lighting strikes the screen.
- Place your TV set too close to a wall, in a confined area or in a very warm location.
- Change the plug's safety prong. See note below.

DO:

- Use soft and indirect lighting.
- Sit at least 6 feet away from the set.
- Provide normal air circulation for reliable long life.
- Plug into an electrical outlet with standard house power. (120 volt AC, 60Hz)

Note:

- As a safety feature, the plug has one prong wider than the other. It will fit only one way into a standard electrical outlet. If the plug will not fit into the outlet, try turning it around. If the plug will not fit either way, the outlet is probably old and non-standard. You will need to have a new outlet installed by an electrician. **DO NOT CHANGE THE SAFETY FEATURE OF THE PLUG.**

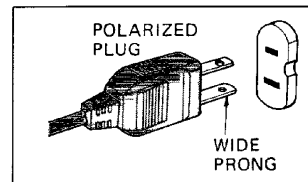

ANTENNA/CABLE TV CONNECTION

The TV picture performance is only as good as the signal it receives.

You will get better picture quality if you use a home antenna or connect your TV to a cable TV system. Cable TV reception is only possible by connecting a cable supplied by your local cable operator.

TYPES OF ANTENNA CABLES

Shown below are two basic types of antenna cables. Signals from a home antenna may be conducted through either type. Cable TV signals will always be conducted through 75 ohm coaxial cable.

1. A 75 ohm system is generally a round cable with F-type connectors that can easily be attached to a terminal without tools.
2. A 300 ohm system is a flat "twin-lead" cable that can be attached to a terminal through an antenna adapter supplied as an accessory.

Optional F-type connector

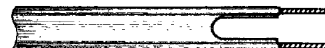

Note: To minimize possible interference, use 75 ohm coaxial cable for VHF antenna connection as possible. If 300 ohm twin-lead cable is used, keep it away from the power cord and other connecting cables.

ANTENNA/CABLE TV CONNECTION

The following illustrations show the antenna connection panel on the back of the TV set and the supplied antenna adapter.

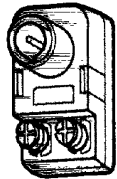

Antenna adapter

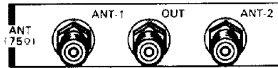

There are two separate 75 ohm F-type connector terminals and a converter output terminal.

The ANT-1 and ANT-2 terminals are for connecting VHF/UHF antenna lead-in cable or CATV cable. The signal which comes in on the ANT-1 also goes out of the OUT terminal whenever the RF switcher in the TV is in the ANT-2 position. You can switch between the ANT-1 and ANT-2 positions by pressing the ANT 1/2 button or the ANT/VIDEO button as shown below.

The antenna adapter is to be inserted between the TV and antenna cable whenever the existing cable is a flat 300 ohm twin-lead cable.

ANT 1/2 BUTTON (on the Remote Control Unit)

Each time you press the ANT 1/2 button on the Remote Control Unit, "ANT 1" or "ANT 2" appears on the screen to show which antenna source you are watching. Select the mode that matches the antenna terminal you utilize. See page 10 for the control's location.

Note: This button does not function in the VIDEO mode.

<Example >

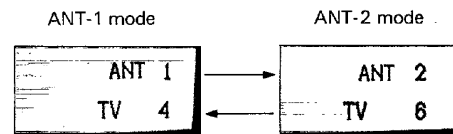

ANT/VIDEO BUTTON (on the TV set)

Each time you press the ANT/VIDEO button on the TV set, "ANT 1", "ANT 2", "VIDEO 1", "VIDEO 2" or "VIDEO 3" appears on the screen in the following order to show which signal source you are watching. Press the button until you see "ANT 1" or "ANT 2" on the screen.

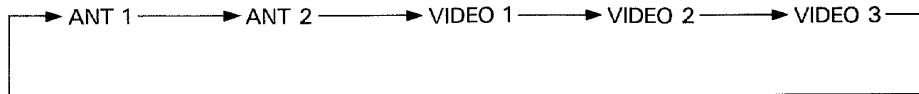

Note: See page 39 for the use of the VIDEO modes.

HOME ANTENNA CONNECTION

When a single lead-in cable is connected

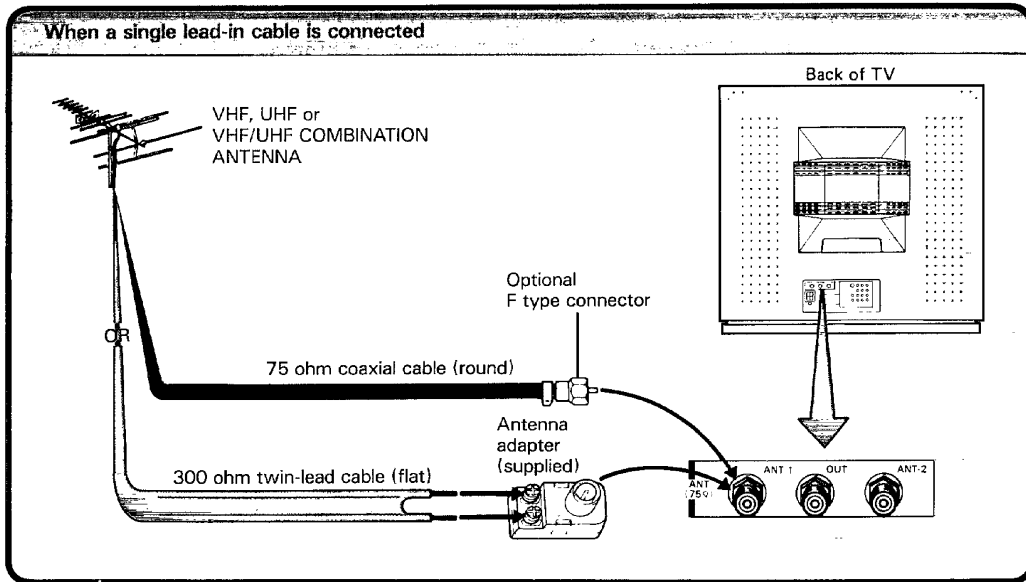

When both VHF and UHF lead-in cables are connected

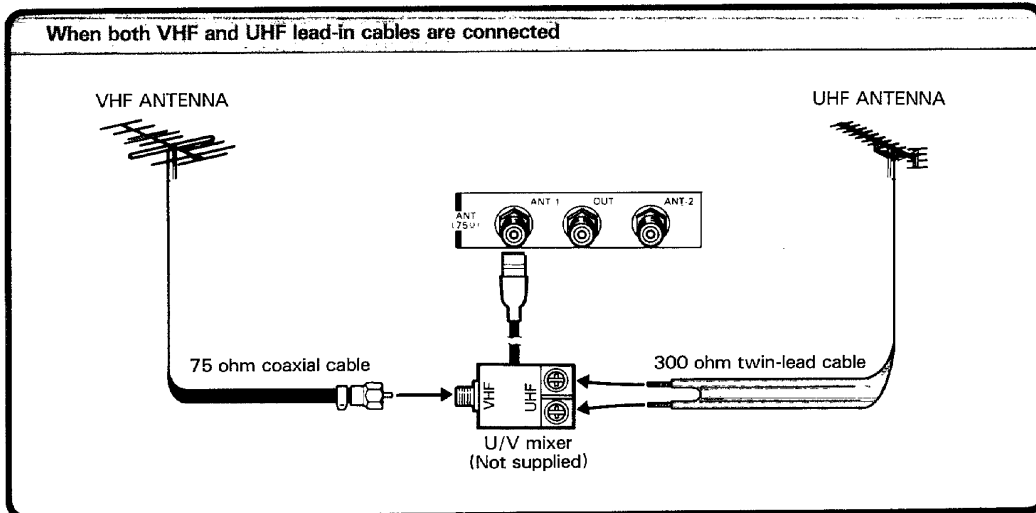

ANTENNA/CABLE TV CONNECTION (Continued)

CABLE TV CONNECTION

Generally, the incoming cable for a Cable TV system can be connected directly to the TV antenna terminal just like a home antenna connection. Simply attach it to the ANT-1 or ANT-2 terminal. You will be able to receive unscrambled cable channels.

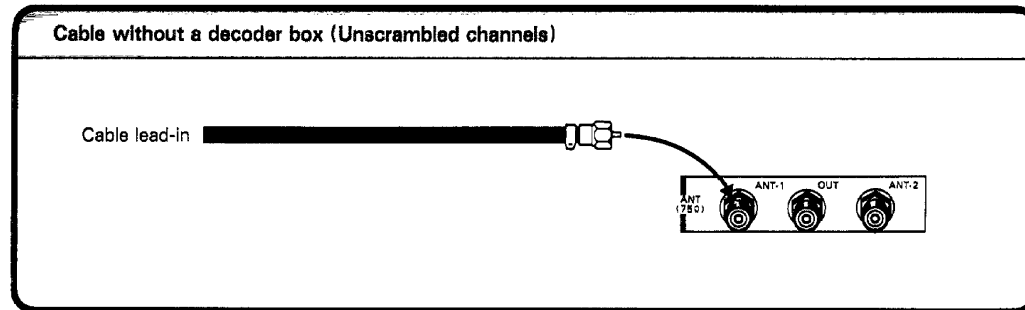

Some cable companies offer "premium pay channels". Since the signals of these premium pay channels are scrambled, a cable TV converter/decoder is generally provided to the subscriber by the cable TV company. This decoder box is necessary for normal viewing of the scrambled channels. For more specific instructions on installing cable TV, consult your cable TV company.

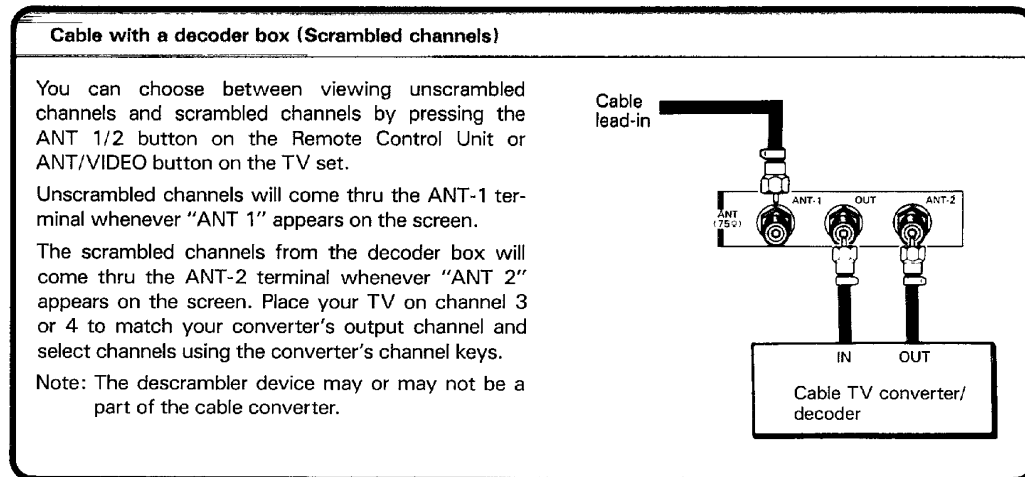

ANTENNA/CABLE TV AND VCR CONNECTIONS

VHF and/or UHF antenna, or Cable (unscrambled channels) connection

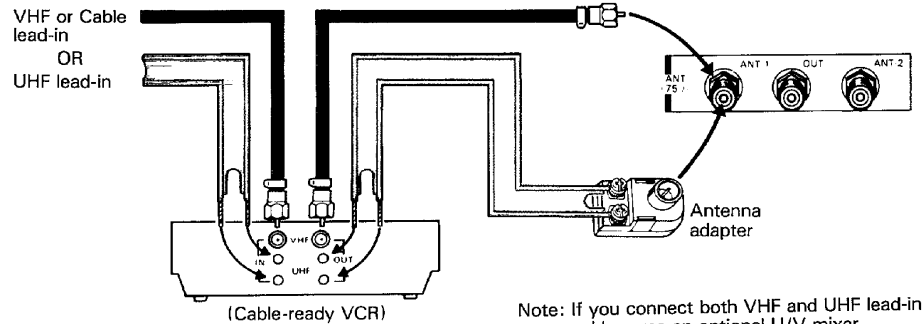

Note: If you connect both VHF and UHF lead-in cables, use an optional U/V mixer. (See page 5.)

Cable with a decoder box (Scrambled channels)

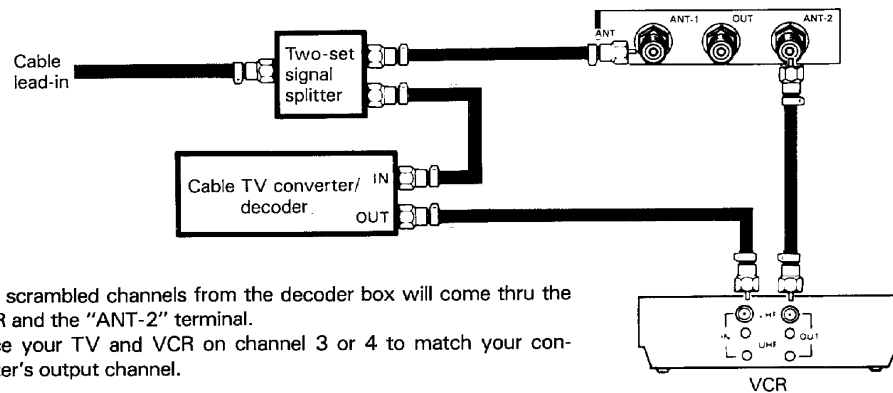

The scrambled channels from the decoder box will come thru the VCR and the "ANT-2" terminal. Place your TV and VCR on channel 3 or 4 to match your converter's output channel.

Note: This TV set is equipped with AUDIO/VIDEO INPUT jacks. By using these jacks for playing back video material, you will get better picture and sound quality from your VCR than you would by connecting them at the antenna connection. See page 39.

LOCATION OF CONTROLS

For the use of each control, see the pages in brackets.

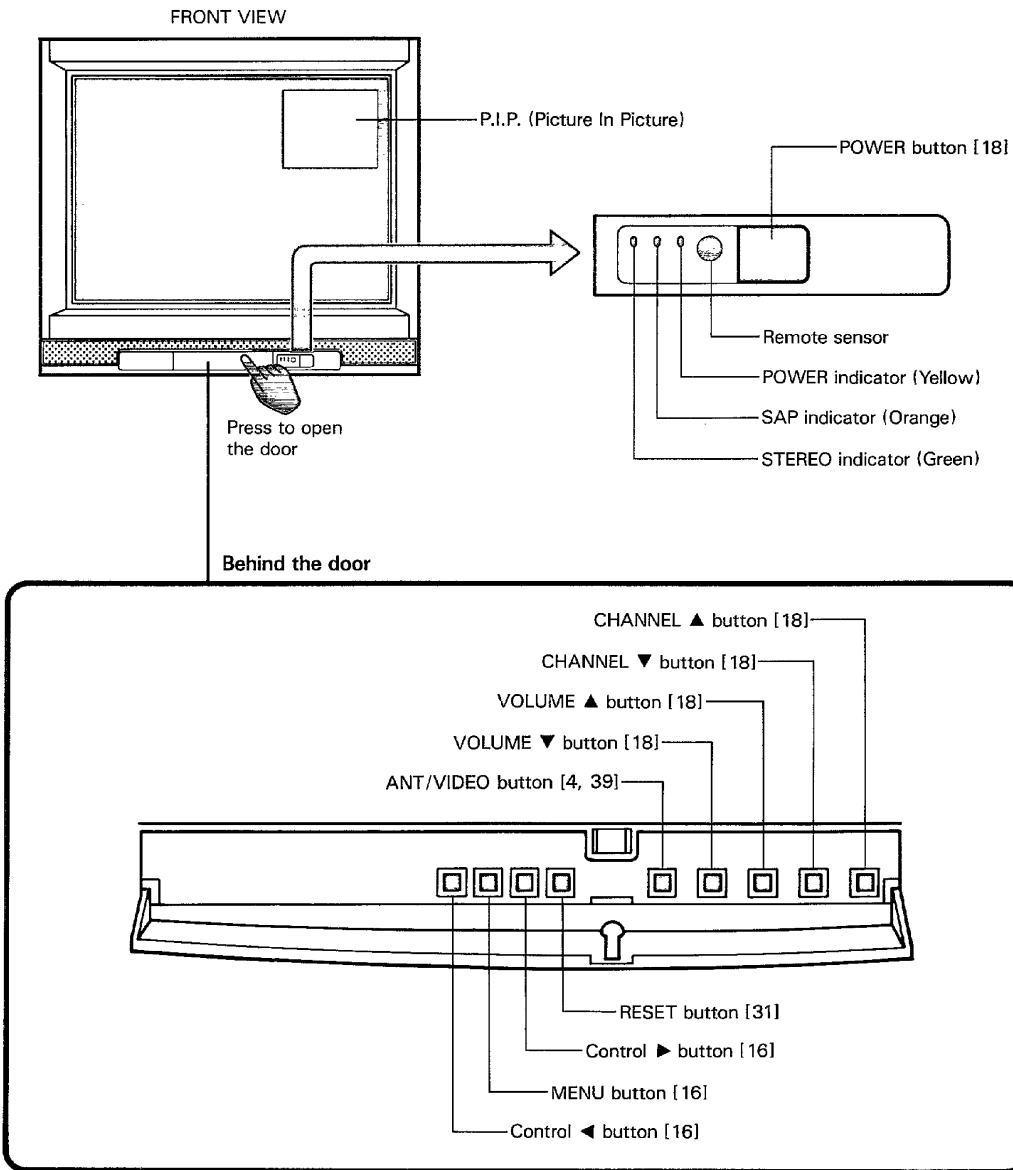

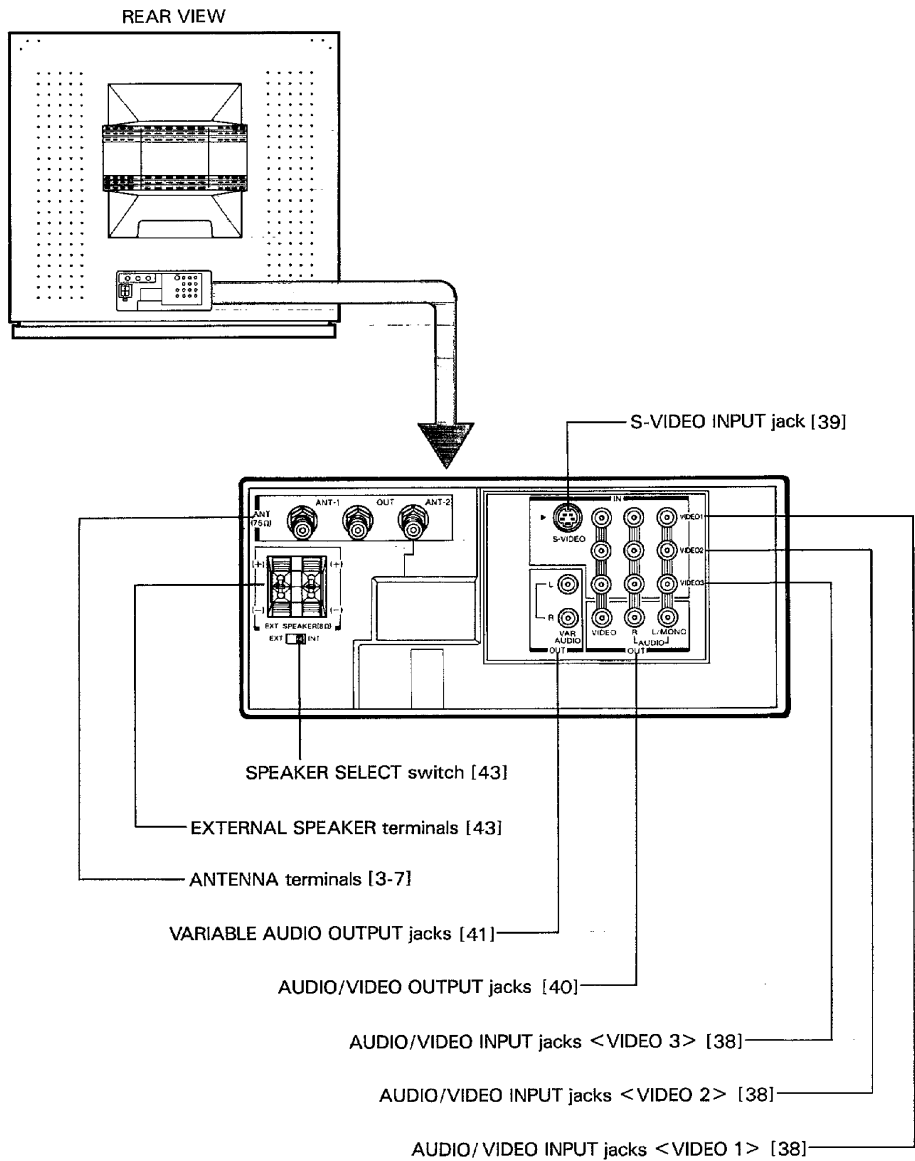

LOCATION OF CONTROLS (Continued)

REMOTE CONTROL UNIT — TV FUNCTIONS

For details on the use of each control, refer to the pages in brackets.

Note: For VCR and CABLE functions, see pages 12 and 13.

Aim at the remote sensor on the TV set

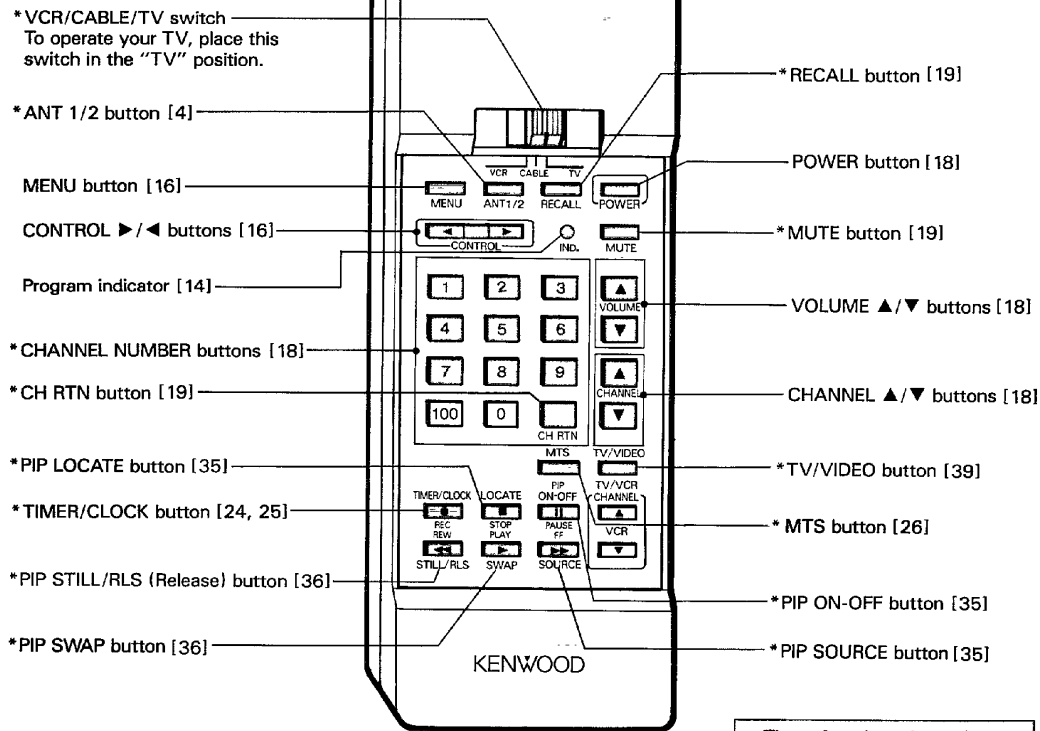

* These functions do not have duplicate locations on the TV set. They can be controlled only by the Remote Control Unit.

USING THE REMOTE CONTROL UNIT

INTRODUCTIONS

This Remote Control Unit allows you to operate your TV set and most models of remote-controlled VCR's and Cable TV Converters even if they are different brands. However, this Remote Unit must be programmed to control other brands of VCR's and/or Converters.

- Before attempting to operate your Remote Unit, install the batteries according to the section "INSTALLING AND REPLACING BATTERIES" shown below.
- For more detailed instructions, see the section "PROGRAMMING THE REMOTE CONTROL UNIT" on page 14.

INSTALLING AND REPLACING BATTERIES

1. Place the Remote Control Unit with the face down. Push down the tab and pull out from top to remove the battery cover.

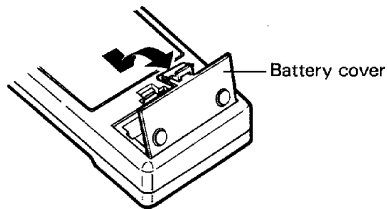

2. Place the two "AAA" size alkaline batteries, matching the + and - signs on each battery to the + and - signs in the Remote Unit.

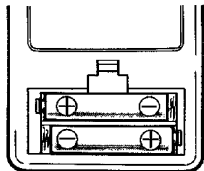

3. Replace the battery cover until the lock snaps.

Note:

- After installing new batteries, the Remote Control will set itself to code "1" for VCR and CABLE modes. If you are using the Remote Control to operate equipment that uses different codes, it will have to be reprogrammed for those codes.
- This Remote Unit may have functions not available on the original remote control unit. These functions may or may not operate your VCR or Cable TV Converter. Refer to the owner's manuals supplied with the equipment to see which functions are available.
- The remote unit supplied with your VCR or Cable TV Converter may have keys not duplicated on this Remote Unit. If these functions are desired, the original remote unit will have to be used.
- If your Cable TV Converter has a volume control, adjust it for maximum volume level. Then adjust the volume using the VOLUME control on the TV set.

TIPS FOR BEST OPERATION

- For optimum performance, aim the Remote Unit directly at the equipment it is being used to operate and be sure there is no obstruction between the Remote Unit and the TV set.
- If your Remote Unit does not always adjust the set as you wish, you probably need to replace the batteries. See the directions at the left. Use alkaline batteries for longer life.
- Remove dead batteries immediately to prevent battery acid from leaking into the battery holding area.
- If you do not intend to use the Remote Unit for a long period, remove the batteries.

CAUTION:

- Do not throw your batteries into a fire. Dispose of your batteries in a designated disposal area.
- Do not combine used old batteries with new ones.
- Do not mix battery types.

USING THE REMOTE CONTROL UNIT (Continued)

USING THE REMOTE WITH VCR

Aim at the VCR



VCR/CABLE/TV switch
To operate your VCR, place this switch in the "VCR" position.

Numbered buttons
Press the numbers desired for direct access.

PAUSE/STILL button
Press to freeze the picture during playback or recording. Press again to release.

STOP button
Press to stop the tape.

RECORD button
A recording starts by pressing this button.

REWIND button
Press to rewind tapes. In playback mode, press and hold to view picture moving rapidly in reverse.

PLAY button
Press to playback a tape.

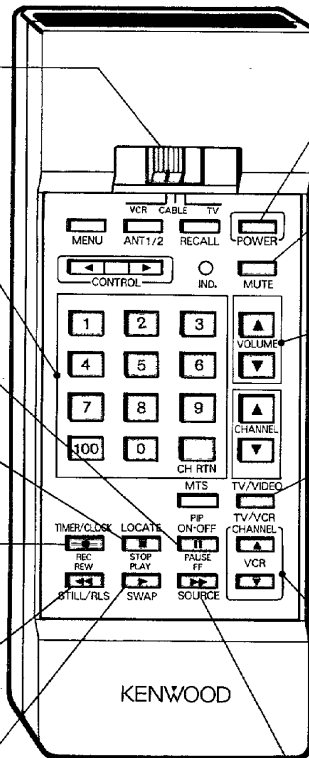

POWER button
Press the button to turn the VCR on. Press again to turn off.

***MUTE button**
Press to turn sound off while the picture remains. Press again to turn the sound back on.

***VOLUME ▲/▼ buttons**
Press ▲ button to increase volume. Press ▼ button to decrease volume.

TV/VCR button
Press to the VCR mode to view the playback of a tape or to monitor a recording. Press to the TV mode to view one program while recording another program.

CHANNEL ▲/▼ buttons
Press ▲ button to scan up. Press ▼ button to scan down.

FF button
Press to rapidly advance the tape. In playback mode, press and hold to view the picture moving rapidly in forward direction.

* The VOLUME ▲/▼ and MUTE buttons will always operate the TV set regardless of the VCR/CABLE/TV switch position. When using these buttons, aim the Remote Unit at the TV set.

USING THE REMOTE WITH CABLE TV CONVERTER

Aim at the Cable TV Converter

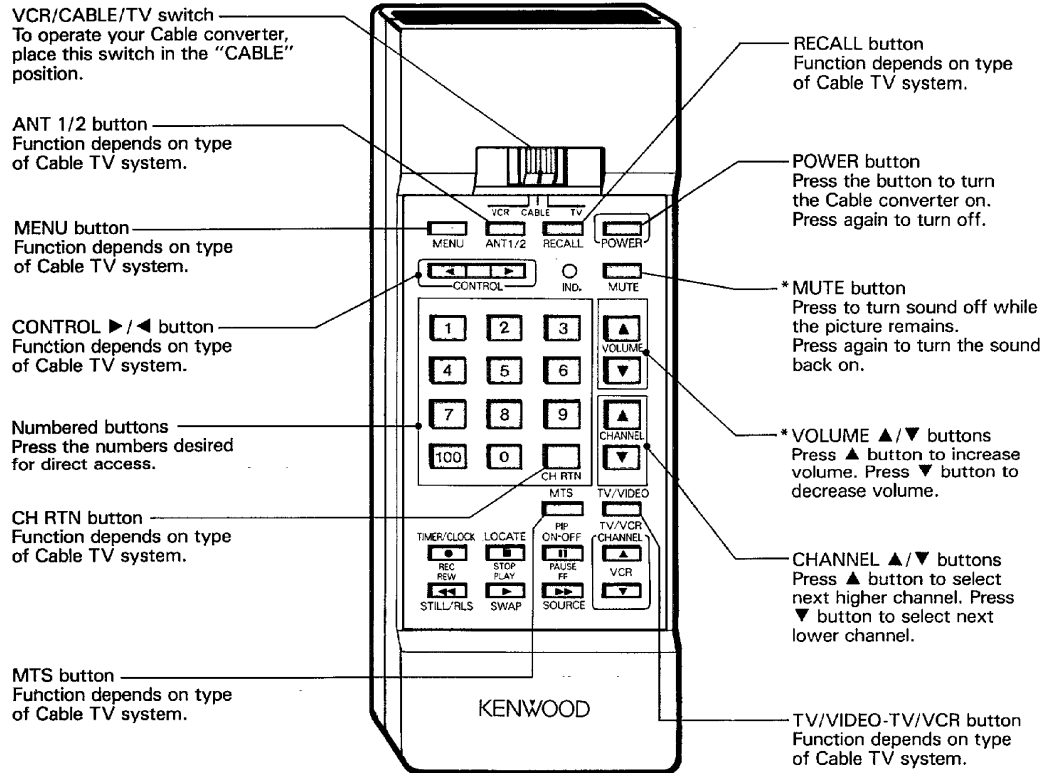

* The VOLUME ▲/▼ and MUTE buttons will always operate the TV set regardless of the VCR/CABLE/TV switch position. When using these buttons, aim the Remote Unit at the TV set.

USING THE REMOTE CONTROL UNIT (Continued)

PROGRAMMING THE REMOTE CONTROL UNIT

Before using this Remote Control Unit, it must be programmed to recognize the brands of the VCR and Cable TV Converter box it will be used to operate.

TO CONTROL OTHER BRANDS OF VCR AND CABLE TV CONVERTER BOX

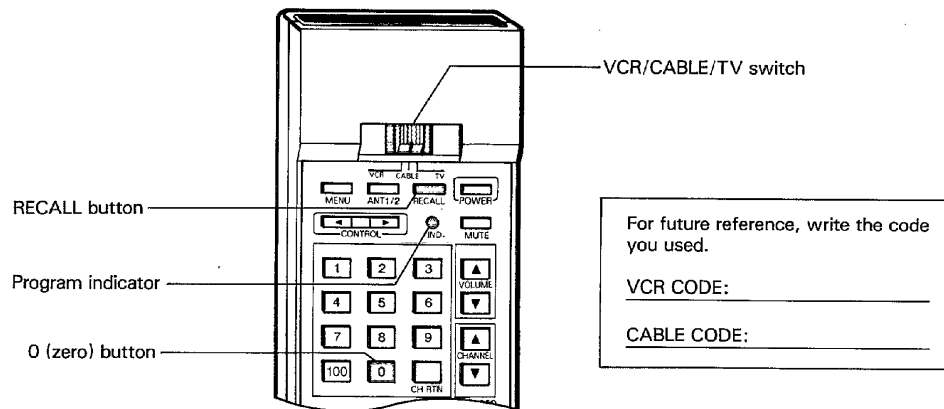

1. Place the VCR/CABLE/TV switch on the Remote Control Unit in the "VCR" position.

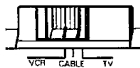

2. Simultaneously hold down the RECALL and "0" buttons until the indicator light on the Remote turns on (about 5 seconds).

3. Refer to the "VCR CODE TABLE" on the next page to find the code number that corresponds to the brand name of your VCR.

Press one or two number buttons to enter the code number for your brand of VCR.

Note:

- Some manufacturers use several different types of remote controls. If your brand has several numbers listed, simply try each one until you find the one that works.
- If more than two digits are entered, the last two digits entered will be selected.

4. After entering the one or two digit code number, press the RECALL button. The indicator light should go out immediately, indicating that it has accepted the programming for that component.

Note: If the light fails to go out as soon as the RECALL button is pressed, an error has been made. Repeat steps 2 through 4.

5. To program the Remote to recognize your Cable TV Converter box, put the VCR/CABLE/TV switch in the "CABLE" position.

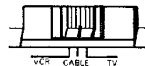

6. Repeat steps 2 through 4, using the code shown in the "CABLE TV CONVERTER BOX CODE TABLE" on the next page for your brand of equipment.

Note: After installing new batteries, the Remote Control will set itself to code "1" for VCR and CABLE modes. If you are using the Remote Control to operate equipment that uses different codes, it will have to be reprogrammed for those codes.

VCR CODE TABLE

BRAND NAME	CODE NUMBER	BRAND NAME	CODE NUMBER
AKAI	24, 33	PIONEER LASER DISK	39
BROKSONIC	21	QUASAR	14
CANNON	14	RCA	15, 16, 20, 27, 28
CITIZEN	9	REALISTIC	6, 12, 14, 31
CURTIS-MATHES	14	SAMSUNG	20, 30
EMERSON	3, 21, 23, 36, 37, 40	SANYO	6, 12
FISHER	11, 12, 13	SCOTT	4, 5, 36
FUNAI	31	SEARS	6, 9, 11, 15
GENERAL ELECTRIC	14, 16, 20	SHARP	8
GOLDSTAR	9	SHINTOM	26
HITACHI	15	SONY BETA	10
JVC	2, 25	SONY SUPER VHS	5, 35
KENWOOD	2, 18	SYLVANIA	7, 14, 27
MAGNAVOX	7, 14	SYMPHONIC	31
MARTA	9	TASHIKO	9
MARANTZ	18	TEAC	31
MGA/MITSUBISHI	4, 22	TEKNIKA	34
NEC	18	TOSHIBA	1
PANASONIC	14	VECTOR RESEARCH	18
PENTAX	15	WARDS	8, 19
PHILIPS	27	ZENITH BETA	10
PIONEER	15, 38	ZENITH VHS	29, 32

CABLE TV CONVERTER BOX CODE TABLE

BRAND NAME	CODE NUMBER	BRAND NAME	CODE NUMBER
DRAKE SATELLITE	34	SCIENTIFIC ATLANTA	16, 33
HAMLIN	19, 2, 3	TEXSCAN	30
GEMINI	31, 5	TOCOM	17, 18
G.I.	5, 6	TOSHIBA SATELLITE	35
JERROLD	4, 7, 8, 9, 10	UNIKA	40
MACON	21	UNIDEN SATELLITE	38
MACON SATELLITE	37	UNITED SATELLITE	39
MAGNAVOX	36	VID TECH	33
OAK	11, 12, 32	VIEWSTAR	26, 27
PANASONIC	13, 20	ZENITH	1
PARAGON	1	ZENITH/DRAKE SATELLITE	28
PHILIPS	23, 24, 25, 26, 27	ZENITH/TOSHIBA/ MACOM SATELLITE	22
PIONEER	14, 15		
REGENCY	29		

MENU FUNCTION

We suggest you familiarize yourself with the procedure before using the MENU function. To adjust any TV feature the use of the Menu Function is required. The adjustments that can be made to the TV appear on the screen. The chart on the next page shows all the menu pages displayed on the screen using the MENU button and CONTROL ►/◄ buttons.

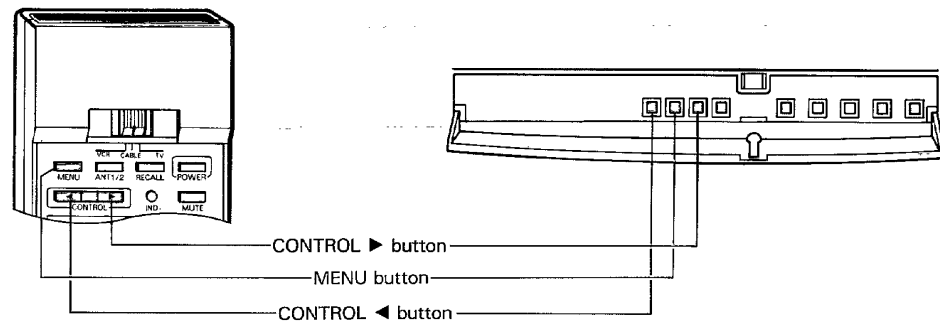

1. Press the MENU button on the TV set or on the Remote Control Unit once. The 1st level "MENU" will appear on the screen as shown below.

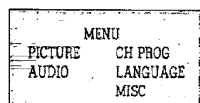

2. Press the CONTROL ► or ◄ button to select the menu you want to adjust. The selected menu will be displayed in magenta. Each time you press the button, the item to be adjusted will be selected in the following order.

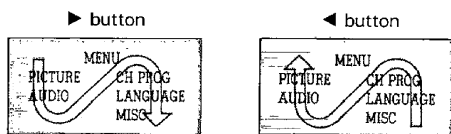

3. Press the MENU button to display 2nd level menu ("PICTURE", "AUDIO", "CHANNEL PROGRAM", "LANGUAGE", or "MISCELLANEOUS").

<Example: PICTURE menu>



4. Press the CONTROL ► or ◄ button to select the item you want to adjust.

5. Press the MENU button to display the adjustment mode.

<Example: CONTRAST adjustment mode display>

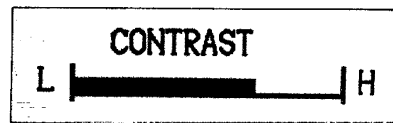

6. Adjust the item displayed on the screen by pressing the CONTROL ► or ◄ button.

The on-screen display will automatically disappear if no control has been operated for about 6 seconds.

Note:

- How to adjust each function is described on a separate page.
- Enter each step within 6 seconds.
- To erase the display instantly, press the RECALL button.

MENU FUNCTION FLOW CHART

For the use of each function, refer to the pages in the brackets.

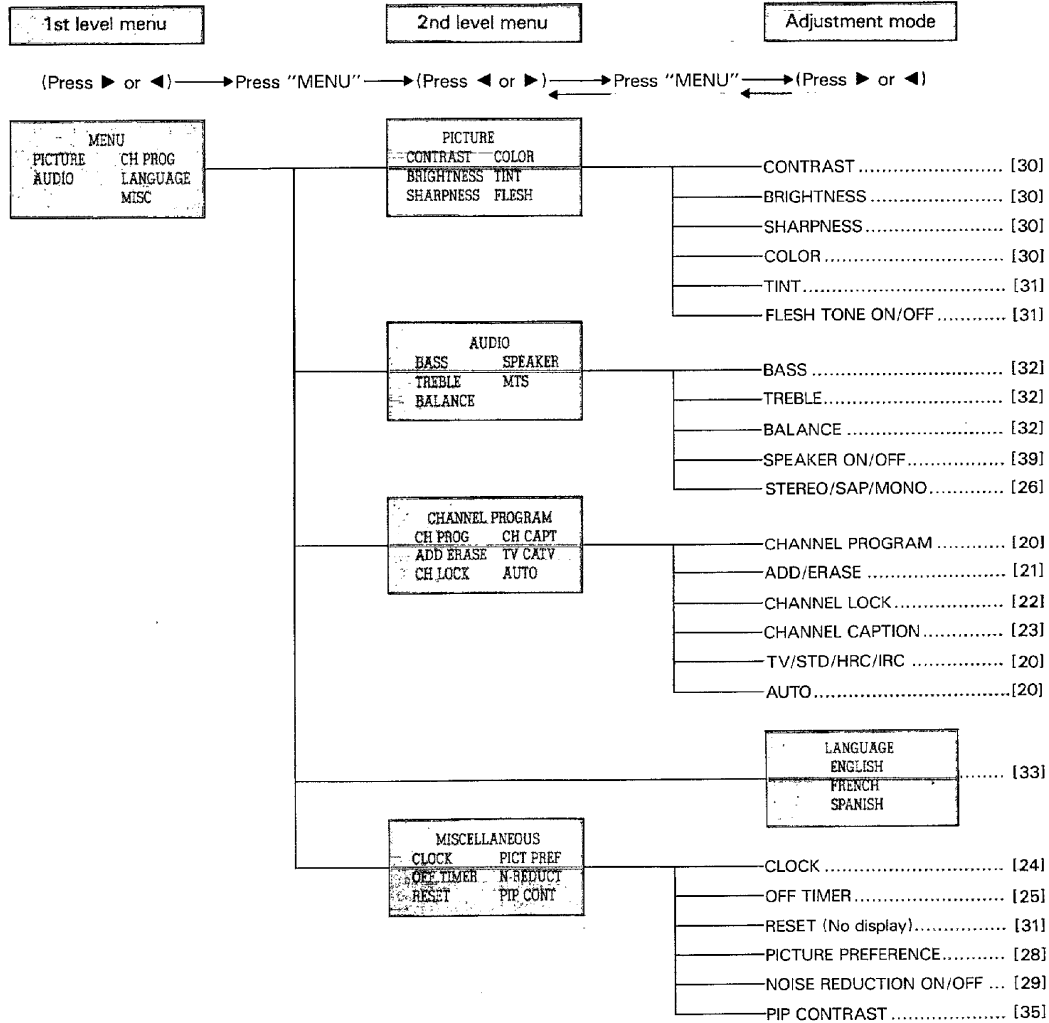

MENU FUNCTION

OPERATION

Generally, the Remote Control Unit is all that is required to operate the TV set.

1 TO TURN THE TV SET ON

Press the POWER button to turn the TV set on. The POWER indicator (Yellow) will light up and the picture will appear in a few seconds. The channel number will be displayed on the screen for a few seconds. To turn the TV set off, press the button again.

2 TO SELECT CHANNELS

Select your desired channels using the CHANNEL NUMBER buttons or the CHANNEL ▲/▼ buttons.

USING THE CHANNEL NUMBER BUTTONS

a. To select channels 1 through 9, two methods are available.

Example: To select channel 4.

One-digit entry — Press "4". Channel 4 will be selected within 2 seconds.

Two-digit entry — Press "0" and "4". Channel 4 will be selected immediately.

b. To select channels 10 through 99, the two-digit entry must be used.

Example: To select channel 38.

Press "3" and "8", and channel 38 will be selected immediately.

c. To select channels 100 through 125, the three-digit entry must be used.

Example: Press "100" (do not press "1"), "2" and "5" in sequence. Channel 125 will be selected.

If the second digit is not pressed within 2 seconds, channel 1 will be selected, and if the third digit is not pressed within 2 seconds, channel 12 is selected.

Note: If you select a channel that is not within the capabilities of this TV, the set will automatically select the lowest memorized channel.

USING THE CHANNEL ▲/▼ BUTTONS

When you have completed channel scan programming according to the instructions, use the CHANNEL ▲/▼ buttons.

Follow the section "CHANNEL PROGRAMMING" on page 20.

Press and release the CHANNEL ▲ or ▼ button. The set will select the next memorized channel. It will not stop at unmemorized channels. Press the button again to select the next memorized channel.

<Example — TV mode>

▲ button — for higher numbered channels.

2 → 3 → 68 → 69 → 2

▼ button — for lower numbered channels.

69 → 68 → 3 → 2 → 69

3 TO ADJUST VOLUME

To increase the volume, press the VOLUME ▲ button. To decrease the volume, press the VOLUME ▼ button.

Press and hold either button until your desired volume level is obtained.

You can see what level by watching the magenta bar displayed on the screen as shown.



After you adjust the volume, the display will remain on the screen for about 2 seconds.

Using the convenient functions with remote only.

MUTE BUTTON

To mute the sound immediately without affecting the picture, press the MUTE button. The word "MUTE" will be displayed on the screen as shown. This is useful during telephone calls or other interruptions. To restore the sound, press the MUTE button again, or press the VOLUME buttons.

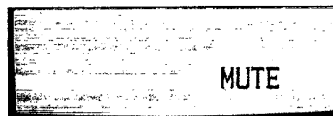

RECALL BUTTON

To call up on-screen information (channel number, time, input source, etc.) for a few seconds, press the RECALL button.

To erase the display instantly, press the button again.

This button will also be used to clear the screen after the on-screen menu adjustments.

Note: To set the on-screen time display, follow the section "SETTING THE CLOCK" on page 24.

<Example>

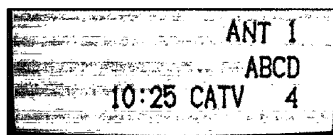

CH RTN (channel return) BUTTON

To return to the last channel that was tuned previously, press the CH RTN button. This is useful should you want to view two channels. This allows you to view two programs without entering the actual channel number each time.

To operate, select the first channel you want to view. Then select the other channel with the CHANNEL NUMBER buttons.

The TV will now change back and forth between the two channels each time you press the CH RTN button.

<Example >

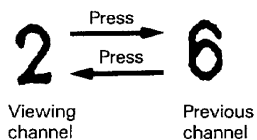

HELPFUL HINTS

- If the power is cut off while you are viewing the TV, and the power is resupplied, the TV is turned on automatically by the **Last Situation Memory** feature. If the power is going to be off for a long time and you might leave your home, remove the power plug from the wall outlet to prevent the TV from turning on in your absence.
- If a vacant channel is tuned or TV broadcast for a day is finished, the TV will automatically turn off after about 15 minutes. However, if the Off-timer is operating, it takes precedence. This **Auto-Power-Off** feature does not operate in the VIDEO mode.
- If you press the RECALL button more than 4 seconds continuously, the various on-screen displays will appear cyclically. It is not due to trouble in the TV. Pressing the button again will release this demonstration mode.

CHANNEL PROGRAMMING

This TV set can memorize channels you use and erase channels you do not use.

When the CHANNEL ▲ or ▼ button is pressed, the TV goes to the next memorized channel. Channel selection is easier and faster.

Proceed with the Channel Programming in the following order.

1. First follow the "AUTO FUNCTION" instructions. In many television viewing areas, programming available channels into memory is an easy one step procedure with the AUTO function.
2. If the AUTO function does not memorize any certain CATV channels, follow the instructions "CH PROG FUNCTION". (You will probably not need to use this function.)
3. When it is decided that certain channels should be erased from the channel memory, the "ADD ERASE FUNCTION" provides complete programming flexibility.

AUTO FUNCTION

1. Press the MENU button once to display 1st level "MENU" shown below on the screen.

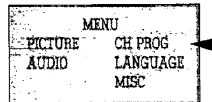

2. Press the CONTROL ► or ◀ button until "CH PROG" is displayed in magenta, then press the MENU button to display 2nd level "CHANNEL PROGRAM" menu shown below on the screen.

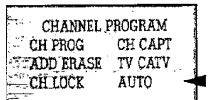

3. Press the CONTROL ► or ◀ button until "AUTO" is displayed in magenta, then press the MENU button. The adjustment mode display will appear on the screen as shown below.



Press the CONTROL ► or ◀ button to begin auto-programming. The TV will automatically check and determine whether the antenna (air), CATV STD, CATV HRC or CATV IRC is being received. Then automatically cycle through all channels and place active channels into the channel memory.

4. When the TV finishes cycle, you can check to see what channels are in memory by pressing the CHANNEL ▲ or ▼ button. If any certain CATV channels are not memorized, continue with the following steps.

CH PROG FUNCTION

A. CHANGING TV/CATV FUNCTION

1. Select 2nd level "CHANNEL PROGRAM" menu on-screen display shown below using the MENU button and the CONTROL ► or ◀ buttons.

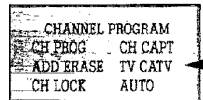

2. Press the CONTROL ► or ◀ button until "TV CATV" is displayed in magenta, then press the MENU button. The adjustment mode display "TV", "STD", "HRC" or "IRC" will appear on the screen.
3. Press the CONTROL ► or ◀ button to select the mode that matches your TV signal. Each time you press the button, the display will change in the following order.

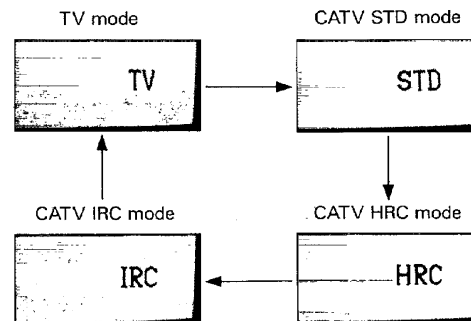

TV/CATV MODE	SIGNAL SYSTEM	RECEIVING CHANNELS
TV	Off the air TV signals	VHF 2-13 UHF 14-69
STD	Standard Cable TV signals	1-125 (Number on this TV)
HRC	Harmonic Related Carrier Cable TV signals	
IRC	Incremental Related Carrier Cable TV signals	

Your cable company can advise you as to which system they are using and the channel number system used in your area.

B. PROGRAMMING CHANNELS

1. Select 2nd level "CHANNEL PROGRAM" menu on-screen display shown below using the MENU button and the CONTROL ►/◄ buttons.

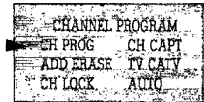

2. Press the CONTROL ► or ◄ button until "CH PROG" is displayed in magenta, then press the MENU button. The adjustment mode display will appear on the screen as shown below.

<Example>



3. Press the CONTROL ► or ◄ button to begin programming.
The TV will automatically cycle through all the TV or CATV channels on the mode selected by the TV/CATV function and place active channels in the channel memory.
When the TV finishes cycling, the programming is complete.
4. Press the CHANNEL ▲ or ▼ button to make sure the channel programming is made properly.

ADD ERASE FUNCTION

A. TO ERASE CHANNELS YOU DO NOT USE

If you want to erase any of the memorized channels.

1. Press the CHANNEL ▲ or ▼ button until the channel you want to erase is selected.

2. Select 2nd level "CHANNEL PROGRAM" menu on-screen display shown below using the MENU button and the CONTROL ►/◄ buttons.

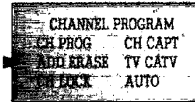

3. Press the CONTROL ► or ◄ button until "ADD ERASE" is displayed in magenta, then press the MENU button.
4. Press the CONTROL ► or ◄ button once.
"ERASED" will appear on the screen indicating that the channel has been erased from the memory.

<Example>



The Added mode and Erased mode will alternate whenever the button is pressed.

5. Repeat steps 1 through 4 until all undesired channels have been erased from the memory.

B. TO ADD CHANNELS

You may want to memorize again the channel which has been erased once.

1. Using the CHANNEL NUMBER buttons on the Remote Control Unit, select the channel you want to memorize.
2. Select ADD/ERASE adjustment mode on-screen display following above steps 2 and 3.
3. Press the CONTROL ► or ◄ button until "ADDED" is displayed on the screen indicating that the channel has been memorized.

<Example>



4. Repeat steps 1 through 3 for other channels.
5. Press the CHANNEL ▲ or ▼ button to make sure the Channel Programming is made as you desire.

You have now completed the channel programming.

CHANNEL PROGRAMMING

LOCKING CHANNELS FOR PARENTAL CONTROL

This feature allows you to program the TV so that any specific channel (for example a channel that you do not want your children to watch) cannot be viewed. You can lock out channels by entering your own 4-digit code and the TV will not be able to tune them for the next 24 hours unless you cancel parental control.

TO LOCK OUT CHANNELS

1. Select a channel you want to lock out.
2. Select 2nd level "CHANNEL PROGRAM" menu on-screen display shown below using the MENU button and CONTROL ►/◄ buttons.

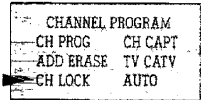

3. Press the CONTROL ► or ◄ button until "CH LOCK" is displayed in magenta, then press the MENU button. The adjustment mode display will appear on the screen as shown below. This TV has 4 memory spaces for the TV mode and the CATV mode respectively.

<Example: TV mode>

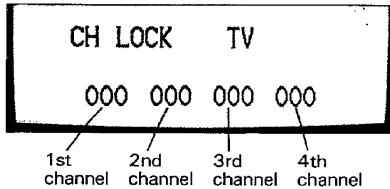

4. Press the CONTROL ► or ◄ button to select the SET mode as shown below. Each time you press the button, the Set mode and Clear mode alternate. Press the button until "SET" appears on the screen.

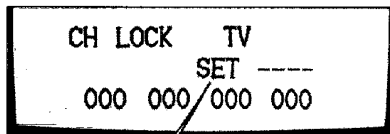

<Set mode> <Clear mode>

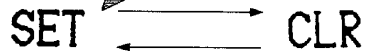

5. Enter a 4-digit code by pressing the Numbered buttons (0 to 9) on the Remote Control Unit. The numbers you enter will replace the dashes in the display. **Pick a number that is easy to remember.**

Example: To enter "1234"

Press "1" Press "2" Press "3" Press "4"
 1--- → 12-- → 123- → 1234

6. Press the MENU button to lock out the channel. At this time, the channel number you locked out will replace "000" in the display as shown below.

<Example: Channel 4 is locked out>

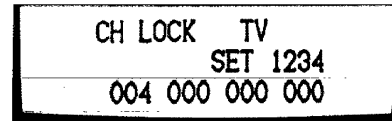

7. Repeat steps 1 through 6 for other channels.
 Note: If a different code number is used whenever you lock out a channel, only the number used for the last channel will remain.
8. Select another channel, or turn off the TV if desired.

TO RESTORE CHANNELS

You may want to restore the channels that have been locked out once.

1. Select "CLR" mode following the above steps 1 through 4.
2. Enter the 4-digit code used to lock out the channels by pressing the Numbered buttons.
3. Press the MENU button.
 If you have entered the code used to lock out the channels, all the locked channel displays will change to "000".
 If wrong code has been entered, the on-screen display will return to 2nd level "CHANNEL PROGRAM" menu. Enter the correct code.

Note:

- If you want to know the channels you have locked out, call up the "CH LOCK" adjustment mode on-screen display using the MENU button and CONTROL ►/◄ buttons.
- Enter each step within 6 seconds.
- To erase the display instantly, press the RECALL button.

CHANNEL CAPTIONING

This feature allows you to enter a 4 letter call out of your choice that will appear over the channel number display. The caption can be anything you want (for example the station call letters).

TO CAPTION CHANNELS

1. Select a channel you want to caption.
2. Select 2nd level "CHANNEL PROGRAM" menu on-screen display using the MENU button and CONTROL ►/◀ buttons.

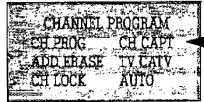

3. Press the CONTROL ► or ◀ button until "CH CAPT" is displayed in magenta, then press the MENU button. The adjustment mode display will appear on the screen as shown below.

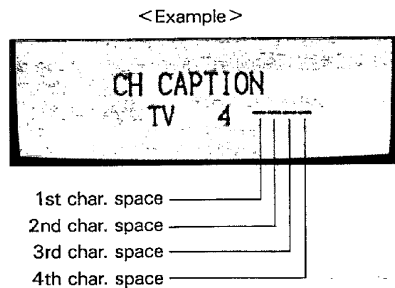

4. Press the CONTROL ► or ◀ button once to put a character in the 1st character space. At this time, 1st bar will change to character display. There are letters of alphabet, numbers and other graphic symbols available for captioning. Each time you press the button, the character to be displayed will change in the following order.

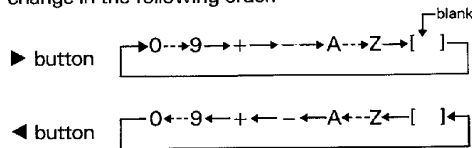

Press the button until the character you want appears on the screen.

5. Press the MENU button once to step to the next character space.

Note: If the MENU button is pressed twice continuously, the adjustment display will disappear.

6. Repeat steps 4 and 5 to enter 2nd, 3rd and 4th characters.

Note: Be sure to press the MENU button once after entering the 4th character.

The channel caption has been placed in the TV's memory.

7. Repeat steps 1 through 6 for other channels.

You can caption up to 32 channels.

The caption you have entered will be displayed whenever the channel is selected or the RECALL button is pressed.

<Example>

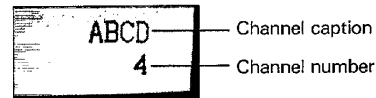

Captioning has now been completed.

TO ERASE YOUR CAPTIONING

1. Select the channel which has the caption you wish to erase.
2. Select the "CH CAPTION" adjustment mode display following steps 2 and 3 at the left column.
3. Enter "[blank]" in all character spaces.

<Example>



The channel caption has been erased.

Note: To erase all the captions you have entered, select the "CH PROG" or "AUTO" function from CHANNEL PROGRAM menu.

SETTING THE CLOCK

This clock can be set using either the MENU function or the TIMER/CLOCK button on the Remote Control Unit.

Using the TIMER/CLOCK Button

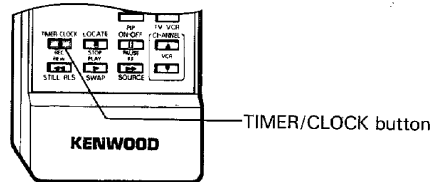

1. Press the TIMER/CLOCK button twice to select the Clock mode. Each time you press the button, the Normal mode, Timer mode or Clock mode will be selected in the following order.

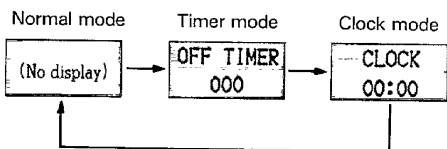

2. Press four Number buttons in order to enter correct time. The blinking indicates that the TV is ready to accept the numbers.

Example: To set the time to 10:25.

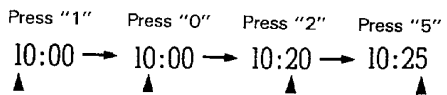

An invalid number can not be entered. For example, 2 through 9 for 1-digit hour and 6 through 9 for 10-digit minute can not be entered.

3. Press the TIMER/CLOCK button once to start the clock. The color of time display will change from red to cyan, and then the display will go off.

Setting completed.

Using the MENU Function

1. Press the MENU button once to display 1st level "MENU" shown below on the screen.

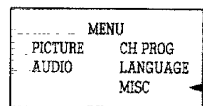

2. Press the CONTROL ► or ◀ button until "MISC" is displayed in magenta, then press the MENU button to display 2nd level "MISCELLANEOUS" menu shown below on the screen.

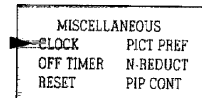

3. Press the CONTROL ► or ◀ button until "CLOCK" is displayed in magenta, then press the MENU button to display the CLOCK setting mode shown below on the screen.

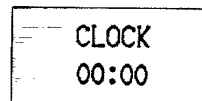

4. Press four Number buttons in order to enter correct time following the step 2 at the left column.
5. Press the MENU button again to start the clock. The color of time display will change from red to cyan, and then the display will go off.

Setting completed.

Note:

- The clock operates on a 12 hour-cycle.
- You can recall the time display to the screen at any time by pressing the RECALL button.
- If the power source of the TV set is interrupted such as unplugged AC cord or power failure, the time set is cancelled. (The time display will show "00:00".)

RECEIVING STEREO/SAP BROADCASTS

The Multi-Channel TV Sound or MTS feature on this TV allows you to improve your TV viewing with high fidelity stereo sound. MTS also provides for an extra channel called Second Audio Program or SAP, used to transmit a second language for bilingual transmission or other sound.

Generally use the MTS button on the Remote Control Unit. If you misplace the Remote Unit, use the MENU function.

Using the MTS Button

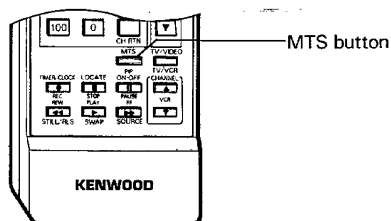

1. Each time you press the button, "STEREO", "SAP" or "MONO" mode is selected in the following order.

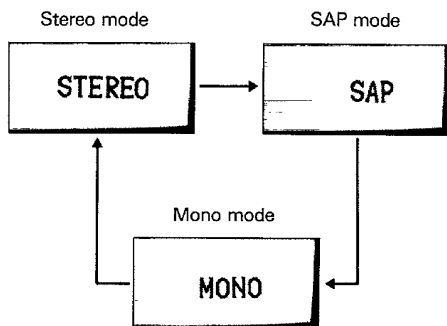

Select the appropriate mode according to various incoming broadcast signals. The mode display will remain for about 2 seconds.

Using the MENU Function

1. Press the MENU button once to display 1st level "MENU" shown below on the screen.

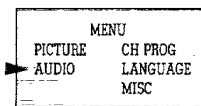

2. Press the CONTROL ► or ◀ button until "AUDIO" is displayed in magenta, then press the MENU button to display 2nd level "AUDIO" menu shown below on the screen.

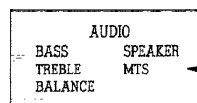

3. Press the CONTROL ► or ◀ button until "MTS" is displayed in magenta, then press the MENU button to select the MTS adjustment mode ("STEREO", "SAP" or "MONO").
4. Each time you press the CONTROL ► or ◀ button, the mode display will change in the following order.

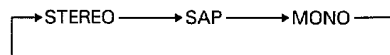

Select the appropriate mode according to various incoming broadcast signals.

LISTENING TO STEREO SOUND

If a channel is broadcasting in stereo, the STEREO indicator (green) shown below will light up.

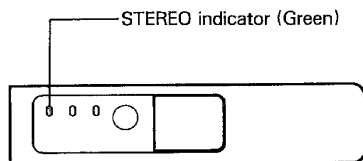

Select the Stereo mode using the MTS button or the MENU function. (See page 26.)

You will be able to hear the stereo sound.

If a broadcasting signal is not strong enough and noise-free stereo sound is not available, select the Mono mode.

The noise should stop.

LISTENING TO SECOND LANGUAGE

If a channel is broadcasting "Second Audio Program", the SAP indicator (orange) shown below will light up.

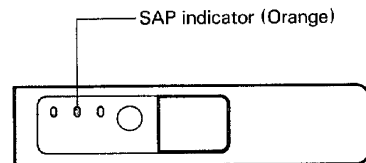

If you want to hear the SAP audio instead of the regular audio, select the SAP mode using the MTS button or the MENU function.

You will hear only the second language from the left and right speakers.

Note:

- Please be sure you have selected the Stereo mode if broadcast is in stereo.
- The selected mode will be retained even after the TV set has been turned off.
- If the STEREO (or SAP) indicator does not light up in spite of a known MTS broadcast, select the Stereo or SAP mode again.

SELECTING PICTURE PREFERENCE FEATURE

This feature allows you to select the tone of the picture you like from among the three modes shown below by using the MENU button and CONTROL ►/◄ buttons.

- **NORMAL mode** — Reproduces optimum picture from original signal source.
The picture quality preset at the factory.
- **THEATER mode** — Reproduces fine detail by reducing harshness and blooming.
This mode should be viewed under darkened room brightness like that in a theater.
- **MEMORY mode** — Reproduces the picture quality you have adjusted last with the PICTURE menu function.
First adjust the picture settings to your preference using the PICTURE menu function. (See page 30.)
The picture settings you have adjusted will be stored in the MEMORY mode.

To Select the Picture Preference

1. Press the MENU button once to display 1st level "MENU" shown below on the screen.

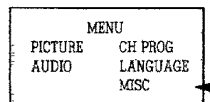

2. Press the CONTROL ► or ◄ button until "MISC" is displayed in magenta, then press the MENU button to display 2nd level "MISCELLANEOUS" menu shown below on the screen.

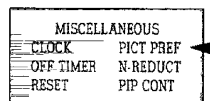

3. Press the CONTROL ► or ◄ button until "PICT PREF" is displayed in magenta, then press the MENU button to display the adjustment mode shown below on the screen.

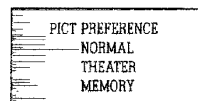

4. Press the CONTROL ► or ◄ button to select your desired mode. Each time you press the button, "NORMAL", "THEATER" or "MEMORY" mode is selected in the following order.

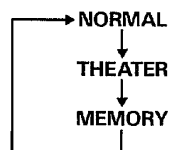

The selected mode will be displayed in magenta.

Selecting completed.

Note: If the RESET button is pressed, the MEMORY mode settings will return to the factory-set level.

OPERATING NOISE REDUCTION FEATURE

This feature allows you to reduce visible interference in your TV picture. This is effective when playing back a video cassette or disc damaged by repeated use.

To Activate the Noise Reduction Feature

1. Select 2nd level "MISCELLANEOUS" menu on-screen display using the MENU button and the CONTROL ►/◄ buttons.

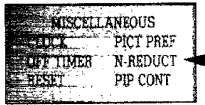

2. Press the CONTROL ► or ◄ button until "N-REDUCT" is displayed in magenta, then press the MENU button to display the NOISE REDUCTION adjustment mode shown below on the screen.

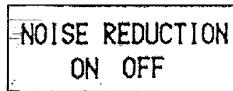

3. Press the CONTROL ► or ◄ button until "ON" is displayed in magenta. The NOISE REDUCTION has now been activated.

To deactivate this feature, select "OFF".

ADJUSTING PICTURE FUNCTIONS

You may wish to adjust picture functions to suit your personal preference. The six kinds of picture functions (CONTRAST, BRIGHTNESS, SHARPNESS, COLOR, TINT and FLESH TONE) can be adjusted using the MENU button and CONTROL ►/◄ buttons. You will see the levels displayed on the screen.

To Adjust CONTRAST

1. Press the MENU button once to display 1st level "MENU" shown below on the screen.

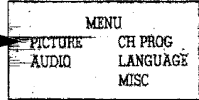

2. Press the CONTROL ► or ◄ button until "PICTURE" is displayed in magenta, then press the MENU button to display 2nd level "PICTURE" menu shown below on the screen.

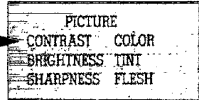

3. Press the CONTROL ► or ◄ button until "CONTRAST" is displayed in magenta, then press the MENU button. The CONTRAST adjustment mode on-screen display will appear as shown below.

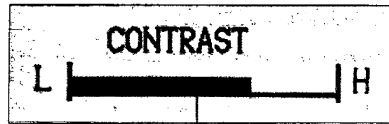

Decrease ← Bar → Increase

Press "►" button to increase contrast. The magenta bar moves right.

Press "◄" button to decrease contrast. The magenta bar moves left.

Press and hold either button until your desired contrast is obtained.

Note: If you continue to adjust other picture functions, press the MENU button while the adjustment mode display remains on the screen. The 2nd level "PICTURE" menu will be selected. This is a quick step approach for total picture adjustments.

To Adjust BRIGHTNESS

1. Select the BRIGHTNESS adjustment mode on-screen display shown below using the MENU button and the CONTROL ►/◄ buttons.

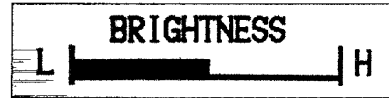

2. Press "►" button to increase brightness. Press "◄" button to decrease brightness. Press and hold either button until your desired brightness is obtained.

To Adjust SHARPNESS

1. Select the SHARPNESS adjustment mode on-screen display shown below using the MENU button and the CONTROL ►/◄ buttons.



2. Press "►" button for sharper picture. Press "◄" button for softer picture. Press and hold either button until your desired sharpness is obtained.

To Adjust COLOR

1. Select the COLOR adjustment mode on-screen display shown below using the MENU button and the CONTROL ►/◄ buttons.

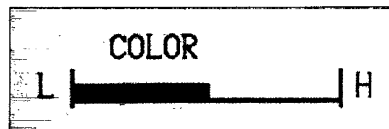

2. Press "►" button to increase color intensity. Press "◄" button to decrease color intensity. Press and hold either button until your desired color intensity is obtained.

To Adjust TINT

1. Select the TINT adjustment mode on-screen display shown below using the MENU button and the CONTROL ►/◄ buttons.

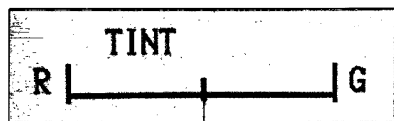

Reddish ← Cursor → Greenish

2. Press "►" button to add green tint to the color tone. Press "◄" button to add red tint to the color tone.
Press and hold either button until natural flesh tone is obtained. You can see what level by watching the cursor displayed on the screen. The cursor will be displayed in yellow at the center (normal setting).

Using FLESH TONE Function

This feature is used to obtain natural flesh tone by correcting the difference of tint between TV stations.

1. Select the FLESH TONE adjustment mode on-screen display shown below using the MENU button and the CONTROL ►/◄ buttons.

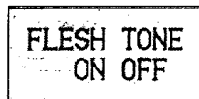

2. Select "ON" mode by pressing the CONTROL ► or ◄ button.
Each time you press the button, "ON" mode and "OFF" mode alternate. Press either button until "ON" is displayed in magenta.

Using RESET Button (on the TV set only)

This single button will adjust all PICTURE and AUDIO functions to the factory-set level instantly. Pressing the RESET button on the TV set will automatically set the Contrast to the maximum and all other functions at the center no matter which color bar is displayed on the screen.

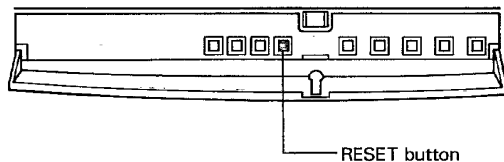

The RESET function may also be adjusted using the MENU button and CONTROL ►/◄ buttons.

1. Select 2nd level "MISCELLANEOUS" menu on-screen display shown below using the MENU button and CONTROL ►/◄ buttons.
2. Press the CONTROL ► or ◄ button until "RESET" is displayed in magenta.
3. Press the MENU button.
The PICTURE/AUDIO functions have now been reset. At this time, the screen displays no message.

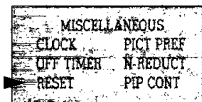

Note: ● Enter each step within 6 seconds.

- To erase the on-screen display instantly, press the RECALL button.

ADJUSTING PICTURE/
AUDIO FUNCTIONS

ADJUSTING AUDIO FUNCTIONS

You may wish to adjust the AUDIO functions to suit your personal preference. "BASS", "TREBLE" and "BALANCE" functions can be adjusted using the MENU button and MENU ►/◄ buttons. You will see the levels displayed on the screen.

To Adjust BASS

This function adjusts the low frequency audio.

1. Press the MENU button once to display 1st level "MENU" shown below on the screen.

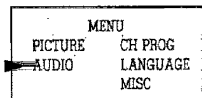

2. Press the CONTROL ► or ◄ button until "AUDIO" is displayed in magenta, then press the MENU button to display 2nd level "AUDIO" menu shown below on the screen.

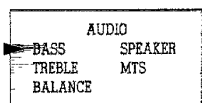

3. Press the CONTROL ► or ◄ button until "BASS" is displayed in magenta, then press the MENU button. The BASS adjustment mode on-screen display will appear as shown below.

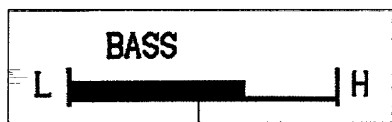

Decrease ← Bar → Increase

Press "►" button to increase bass. The magenta bar moves right.
Press "◄" button to decrease bass. The magenta bar moves left.

Note: If you continue to adjust other audio functions, press the MENU button while the adjustment mode display remains on the screen. The 2nd level "AUDIO" menu will be selected. This is a quick step approach for total audio adjustments.

To Adjust TREBLE

This function adjusts the high frequency audio.

1. Select the TREBLE adjustment mode on-screen display shown below using the MENU button and the CONTROL ►/◄ buttons.



2. Press "►" button to increase treble.
Press "◄" button to decrease treble.

To Adjust BALANCE

This function adjusts the left/right balance of sound from the speakers.

1. Select the BALANCE adjustment mode on-screen display shown below using the MENU button and the CONTROL ►/◄ buttons.

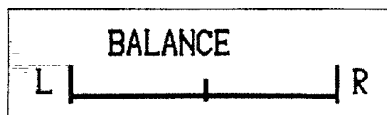

2. Press "►" button to lower sound from the left speaker.
Press "◄" button to lower sound from the right speaker.
You can see what level by watching the cursor displayed on the screen. The cursor will be displayed in yellow at the center.

Note:

- Enter each step within 6 seconds.
- To erase the on-screen display instantly, press the RECALL button.
- The SPEAKER ON/OFF function is explained on page 41.
- The MTS function is explained on page 26.

SELECTING LANGUAGE FOR ON-SCREEN MESSAGE

Three different languages (ENGLISH, FRENCH and SPANISH) are available for the on-screen message, and you can choose the one you desire.

To Select Language

1. Press the MENU button once to display 1st level "MENU" shown below on the screen.
3. Press the CONTROL ► or ◀ button to select your desired language. Each time you press the button, "ENGLISH", "FRENCH" or "SPANISH" mode is selected in the following order.

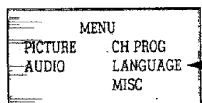

2. Press the CONTROL ► or ◀ button until "LANGUAGE" is displayed in magenta, then press the MENU button to display the adjustment mode shown below on the screen.

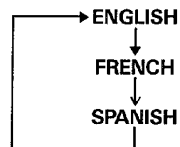
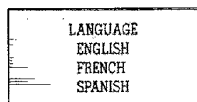

The selected mode will be displayed in magenta.

Selecting completed.

[Example]

<ENGLISH>

<FRENCH>

<SPANISH>

1st level
"MENU" display

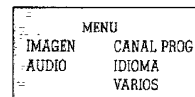
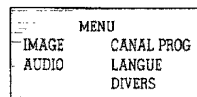
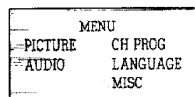

2nd level
"PICTURE" menu display

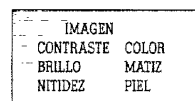
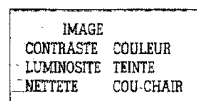
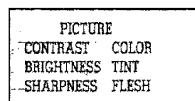

ENJOYING PICTURE IN PICTURE (PIP) FEATURE

In addition to the main picture, another TV program or video source being received through the VIDEO INPUT jack can be displayed simultaneously as a sub picture. After you have connected another video source (such as a VCR) to your TV as shown below, you are ready to display the Picture In Picture (PIP).

Note: When using the PIP, the TV can display two pictures at once. However, one picture must be from an RF ("ANT-1") channel and the other must be from a Video input channel.

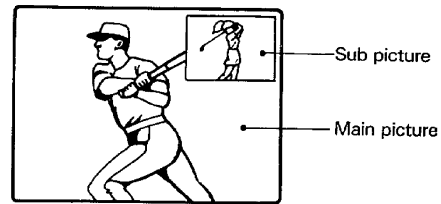

ANTENNA/CABLE TV AND VCR CONNECTIONS

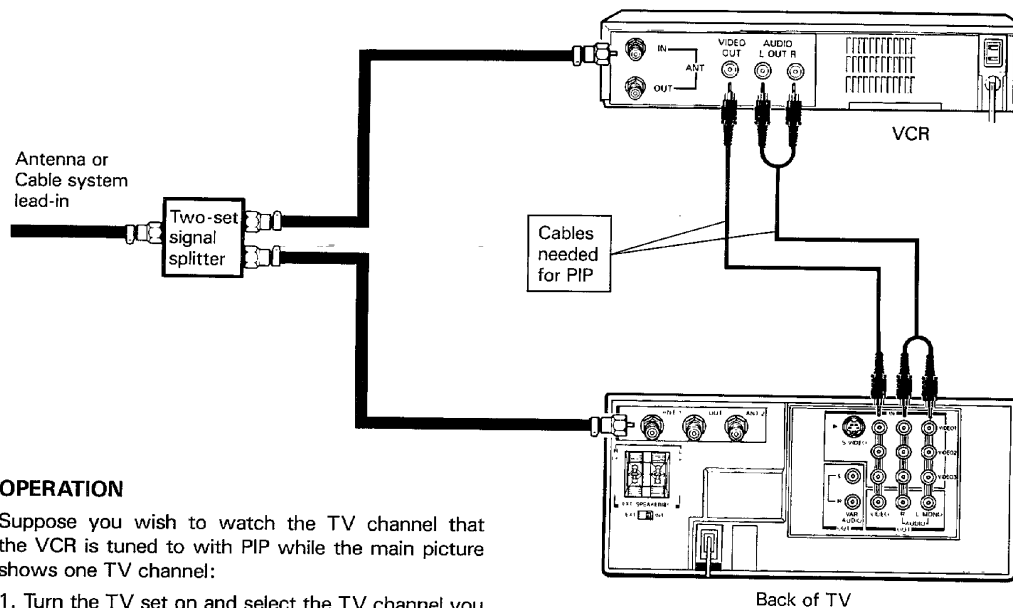

OPERATION

Suppose you wish to watch the TV channel that the VCR is tuned to with PIP while the main picture shows one TV channel:

1. Turn the TV set on and select the TV channel you want to watch using the TV channel keys.
2. Turn the VCR on.
3. Press the PIP ON-OFF button to start the PIP, and select the Video 1 mode by pressing the PIP SOURCE button. If the VCR is connected to the TV's "VIDEO 2" or "VIDEO 3" jacks, select corresponding mode.
4. Select the channel of the PIP using the VCR channel keys.

Note:

- For the PIP viewing, you can connect the VCR to any of the "VIDEO 1", "VIDEO 2" and "VIDEO 3" jacks.
- If you are utilizing the cable TV converter, use the diagram shown on page 7. However, the Audio/Video cables must also be connected as above diagram.
- For detailed instructions for PIP feature, see the Owner's Manual.
- The signal source from "ANT-2" terminal cannot be displayed on the screen.

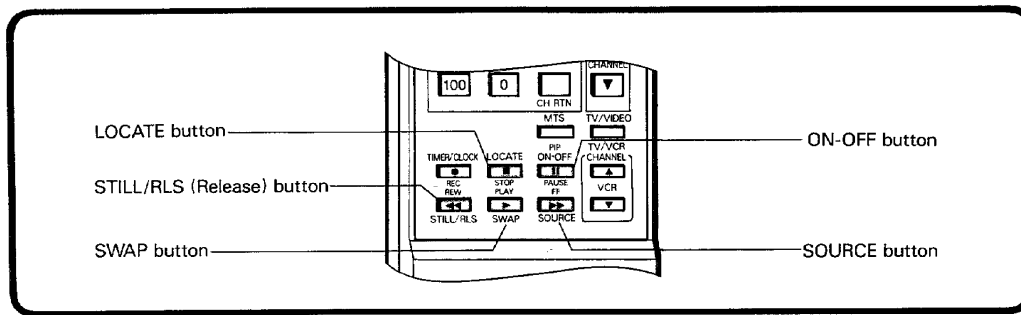

PIP ON-OFF BUTTON

Press the ON-OFF button once to open up the PIP window. On-screen display will show signal source of PIP for about 2 seconds as shown below.

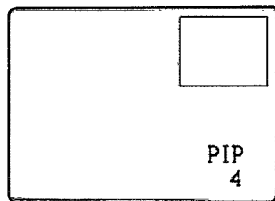

Press the button again to erase the PIP.

PIP LOCATE BUTTON

Press the LOCATE button to move PIP from corner to corner of the main screen. Each time you press the button, PIP will move in the following order.

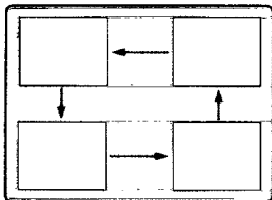

PIP SOURCE BUTTON

Press the SOURCE button repeatedly to select input source, TV, VIDEO 1, VIDEO 2 or VIDEO 3. The input source will change in the following order.

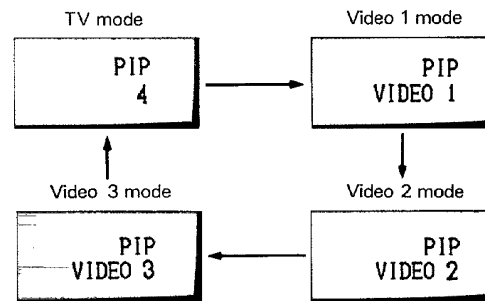

For example, when you want to view another TV channel through a VCR connected to the "VIDEO 1" jacks on this TV while the main picture shows one channel, select the Video 1 mode.

ENJOYING PICTURE IN PICTURE (PIP) FEATURE (Cont.)

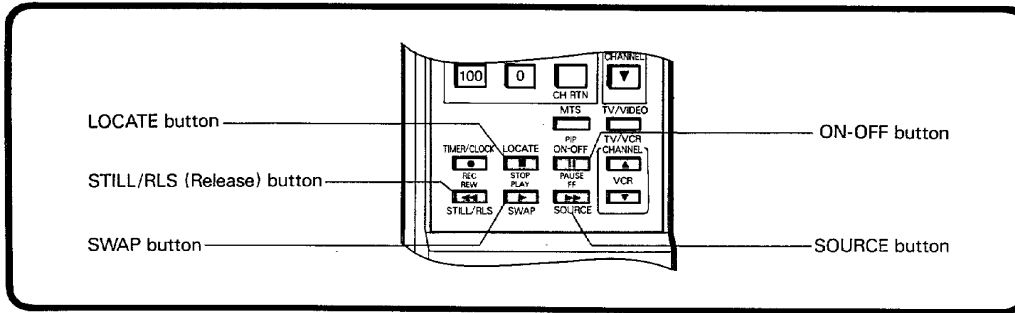

PIP STILL/RLS (Release) BUTTON

Press the STILL/RLS button once while PIP is on the screen to freeze the PIP picture you are now viewing at any point in the action.

To return to an action picture, press the button again.

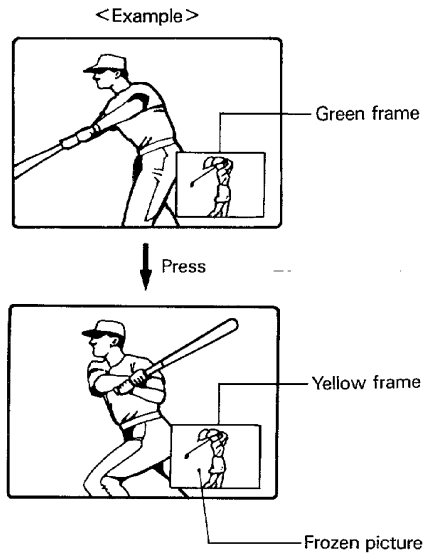

PIP SWAP BUTTON

Press the SWAP button once to switch the PIP picture with the main picture.

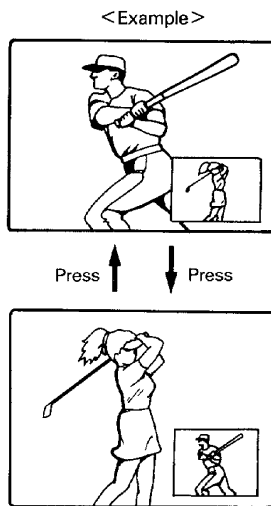

PIP CONTRAST FUNCTION

Contrast adjustment for the PIP picture can be made using the picture menu function.

First press the ON/OFF button to display the PIP picture, then adjust the PIP contrast as follows:

1. Press the MENU button once to display 1st level "MENU" shown below on the screen.

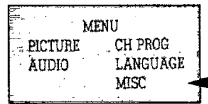

2. Press the CONTROL ► or ◀ button until "MISC" is displayed in magenta, then press the MENU button to display 2nd level "MISCELLANEOUS" menu shown below on the screen.

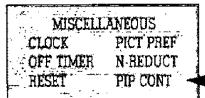

3. Press the CONTROL ► or ◀ button until "PIP CONT" is displayed in magenta, then press the MENU button to display the PIP CONTRAST adjustment mode shown below on the screen.

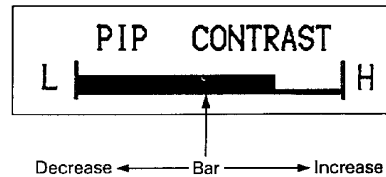

Press "►" button to increase contrast of the PIP picture. The magenta bar will move right.
Press "◀" button to decrease contrast. The magenta bar will move left.
Press and hold either button until your desired contrast is obtained.

Note: If the RESET button is pressed, the PIP contrast will be reset to the maximum (factory-set level).

CONNECTING OPTIONAL EQUIPMENT

This TV set is equipped with AUDIO/VIDEO INPUT jacks (S VIDEO or VIDEO 1/VIDEO 2/VIDEO 3), AUDIO VIDEO OUTPUT jacks, VARIABLE AUDIO OUTPUT jacks and EXTERNAL SPEAKER terminals for connecting your desired equipment.

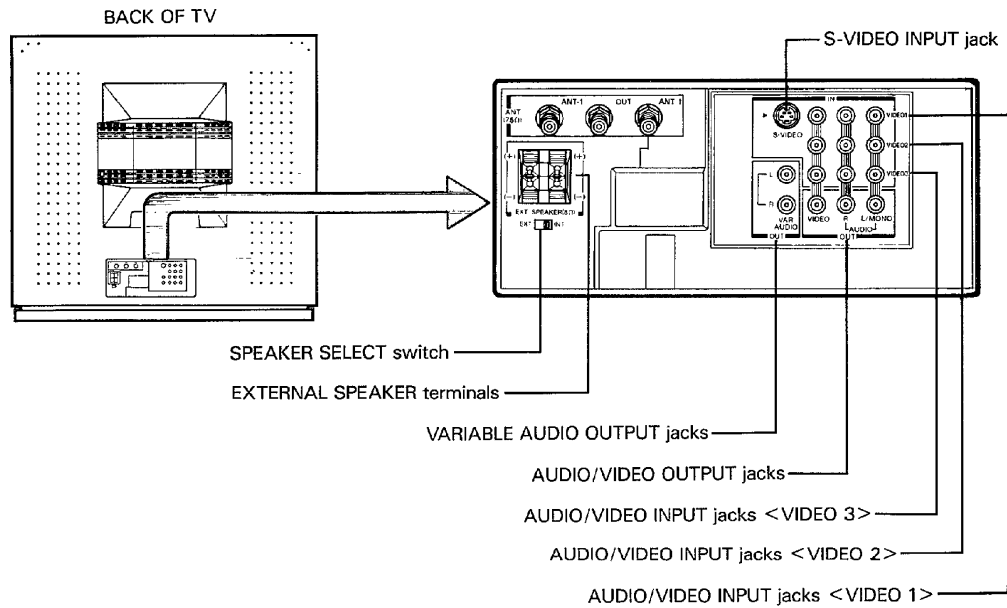

USING THE AUDIO/VIDEO INPUT JACKS

Connect to the audio and video output jacks of a VCR, Video Disc Player (VDP), etc. for playback of video material. The material being played back on the video equipment can be viewed on the TV screen.

<Connection example: VCR → VIDEO 1, VDP → VIDEO 2 >

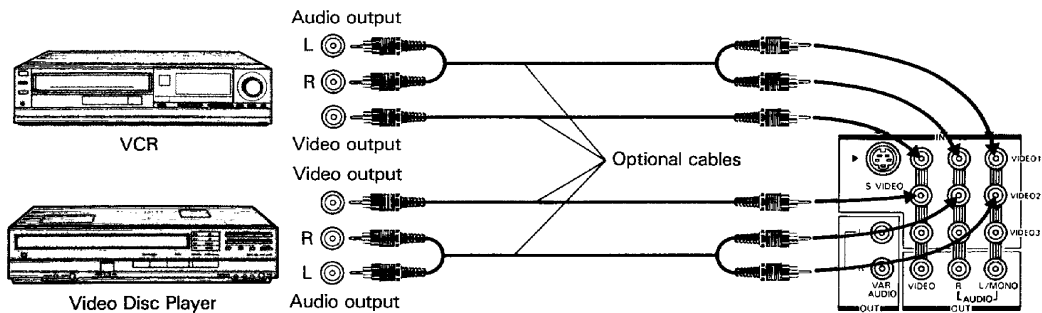

USING THE S-VIDEO/AUDIO INPUT JACKS

If your VCR is equipped with "S-VIDEO" connector, use the following diagram.

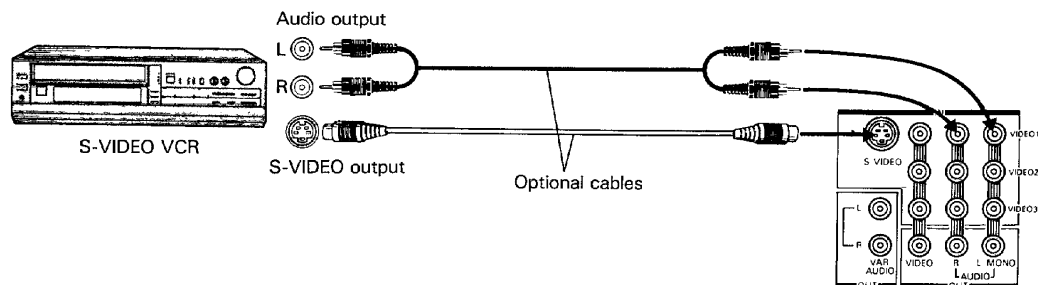

Note:

- "VIDEO 3" inputs can also be used for connecting 3rd audio/video equipment.
- When using monaural sound equipment, connect its AUDIO OUT to the L/MONO jack on the TV set, or use an audio splitter cable and connect to both R and L audio inputs.
- The "S-VIDEO" terminal is connected in common with the "VIDEO" terminal of "VIDEO 1". (If cables are connected to both terminals, the "S-VIDEO" takes precedence.)
- The "S-VIDEO" terminal means separated Luminance/Chrominance (Y/C) signal terminal which conforms to NTSC video signal.

SELECTING VIDEO SOURCES

To operate your TV normally, see instructions supplied with the connecting equipment.

- 1 Turn the TV and VCR (or VDP) on.
- 2 Press the TV/VIDEO button on the Remote Control Unit or the ANT/VIDEO button on the TV set to select the Video 1/S-Video, Video 2 or Video 3 mode. Each time you press the button, the mode display will change in the following order. Press the button until you see "VIDEO 1", "VIDEO 2" or "VIDEO 3" on the screen.

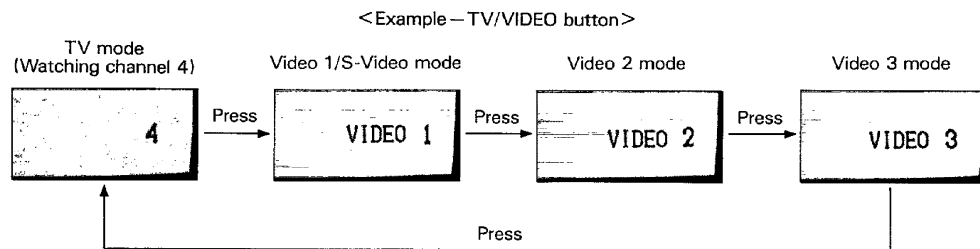

The mode display will remain for about 2 seconds.

- 3 Operate your VCR (or VDP) normally.

Note: The ANT/VIDEO button is explained on page 4.

CONNECTING OPTIONAL EQUIPMENT (Cont.)

USING THE AUDIO/VIDEO OUTPUT JACKS

Connect to the audio/video input jacks of a VCR (or TV monitor etc.). Either the TV or VCR signal selected by the TV/VIDEO button will be supplied.

- Use the hook-up shown below to record a TV program with a VCR or to connect another TV monitor.

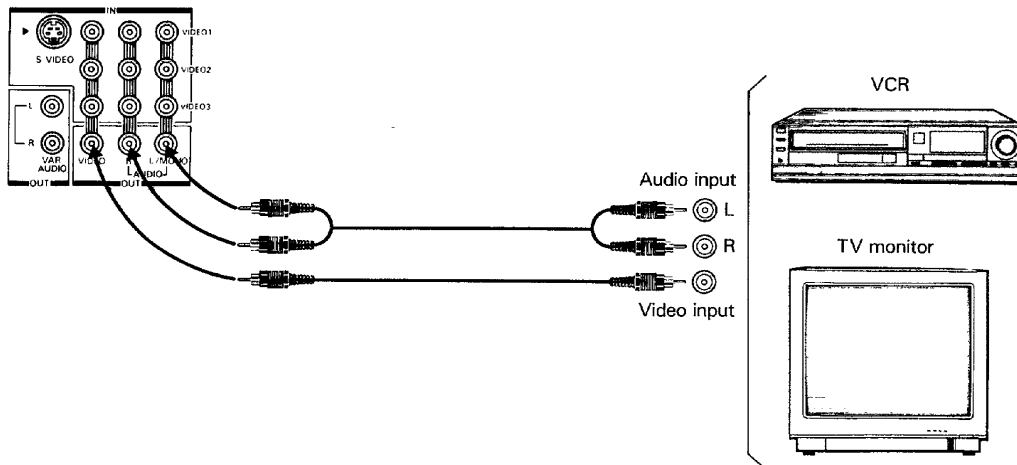

- The "fixed level" audio signal present at the AUDIO/VIDEO OUTPUT jacks is ideal for recording (or amplifying) the audio, from the TV you are listening to, with standard audio components. Adjustment of volume and mute with buttons on the TV or on the Remote Control Hand Unit will not affect the constant audio signal. Set the TV sound volume to minimum and adjust the sound with the controls on the amplifier or cassette recorder.

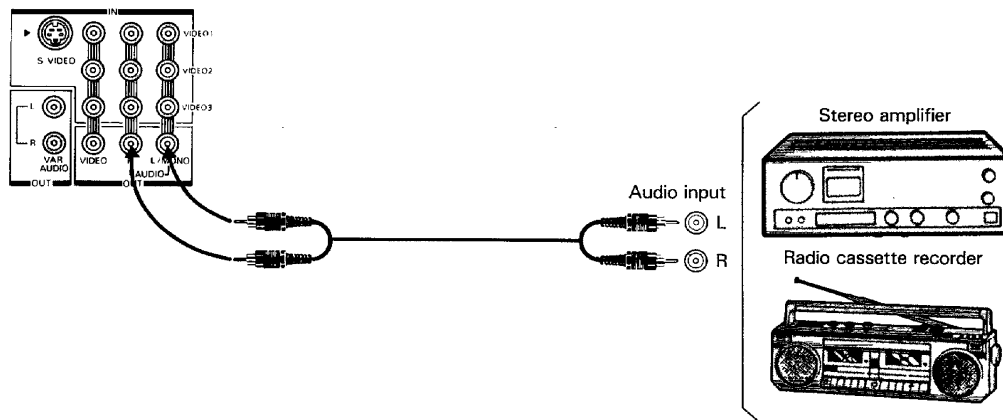

USING THE VARIABLE AUDIO OUTPUT JACKS

These jacks are used for connecting a standard audio amplifier. Controls of volume, bass, treble, balance and mute are retained at the TV. These jacks relay the audio signal of all programs being displayed on the TV screen.

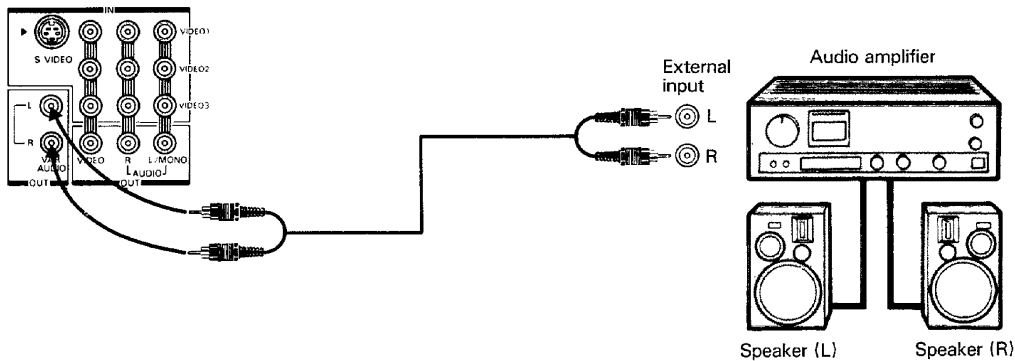

OPERATION

1. Turn the TV set and stereo amplifier ON.
2. Adjust the VOLUME control on the TV for a moderate listening level.
3. Disconnect the built-in speakers following the instructions at the right column.
4. Adjust the volume control on the stereo amplifier for a moderate listening level.
5. Control of the audio can now be done using the audio control (VOLUME, MUTE, BASS, TREBLE and BALANCE) on the TV or on the Remote Control Unit.

TO DISCONNECT THE BUILT-IN SPEAKERS

1. Press the MENU button once to display 1st level "MENU" on the screen.
2. Press the CONTROL ► or ◀ button until "AUDIO" is displayed in magenta, then press the MENU button to display 2nd level menu "AUDIO" shown below on the screen.

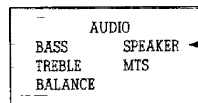

3. Press the CONTROL ► or ◀ button until "SPEAKER" is displayed in magenta, then press the MENU button to display the adjustment mode shown below on the screen.

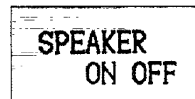

4. Press the CONTROL ► or ◀ button until "OFF" is displayed in magenta. The built-in speakers has now been disconnected.

CONNECTING OPTIONAL EQUIPMENT (Cont.)

DUBBING/EDITING PROGRAMS WITH 2 VCRS

To dub or edit your own video tapes between one VCR and another, connect the VCR that will play to the INPUT jacks on your TV set. Then connect the OUTPUT jacks from your TV set to the input jacks on the recording VCR. See the hook-up diagram below.

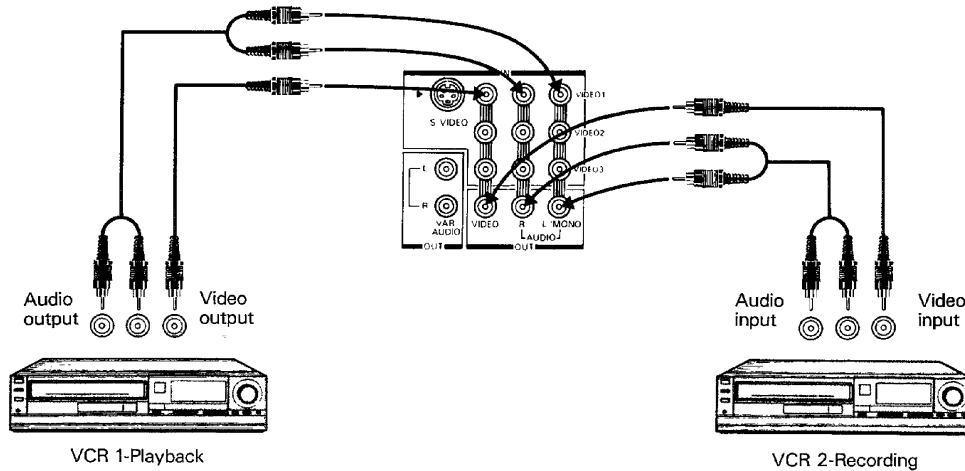

OPERATION (To monitor your dubbing/editing)

- 1 Turn on the TV set and 2 VCR's.
- 2 Select the Video 1 mode by pressing the TV/VIDEO button on the Remote Control Unit. (See page 37.)
- 3 Set the VCR 2 to record mode and the VCR 1 to play.
- 4 You can view the video material from VCR 1 on your TV screen as you dub it to VCR 2.

Note:

- The input switch of VCR is normally in the TV position. Change the switch of recording VCR to the LINE or CAMERA position when using the AUDIO/VIDEO INPUT of the VCR as above. Some VCR's automatically switch when the cables are plugged into the AUDIO/VIDEO INPUT.
- "S-VIDEO", "VIDEO 2" and "VIDEO 3" terminals can also be used for connecting the playback VCR.

CAUTION:

The unauthorized recording of television programs, video tapes and other materials may infringe the provisions of the copyright laws.

CONNECTING EXTERNAL SPEAKERS

You can connect speakers to the EXTERNAL SPEAKER terminals on the TV set to enhance sound from the TV.

Note: Before connecting the external speakers, turn off your TV set.

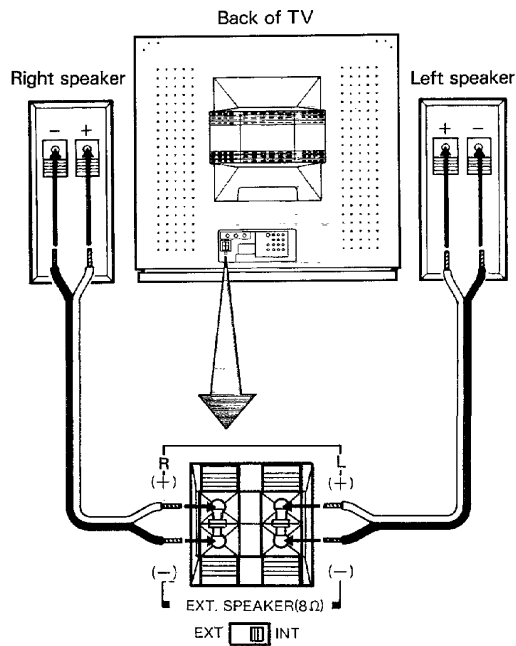

1 Connect speaker leads

While pressing the button, insert the wire into the hole as shown below, and then release the button.

Pull firmly on the wire to make sure it is secure.

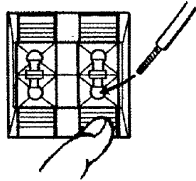

Note: Be sure to connect the Right speaker to the R + and - and the Left speaker to the L + and -.

2 Set the SPEAKER SELECT switch

Push the switch to "EXT" side (left). The built-in speakers are disconnected.



Note:

- Do not connect two sound sources to the same speaker system. You may damage the TV.
- Use only external speakers with an impedance rating of 8 ohms and input power 10 watts or greater.
- Keep the speaker leads away from the power cord and antenna cables.

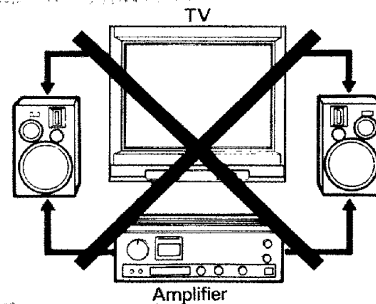

CLEANING AND CARE

WARNING: TV sets use High Voltages. Do not try to remove the cabinet back. Refer servicing to qualified service personnel.

- To clean the TV screen:
 1. First remove the plug from the power outlet to avoid possible shock hazard.
 2. Use a clean cellulose sponge or chamois cloth dampened with a solution of mild detergent and warm water to clean TV screen and trim. Do not use too much water on the TV screen.
 3. Remove any extra moisture with the same cloth or a dry one.
 - To maintain the finish and appearance of the cabinet, polish it from time to time with a quality furniture polish.
- Note: Never use strong solvents such as thinner, benzine or other chemicals on or near cabinet, as they might damage the finish of the cabinet.

SPECIFICATIONS

TELEVISION SYSTEM:	NTSC standard
CHANNEL COVERAGE:	VHF; 2 through 13 UHF; 14 through 69 Cable TV; mid band (A-1 through A-8, A through I) super band (J through W) hyper band (AA through ZZ, AAA, BBB) ultra band (65 through 94, 100 through 125)
POWER SOURCE:	120V AC, 60Hz
POWER CONSUMPTION:	143W (average)
AUDIO POWER:	10W + 10W
SPEAKER TYPE:	Two 2-3/4" x 5-1/4" oval
VIDEO/AUDIO TERMINALS:	S-VIDEO INPUT Y-INPUT: 1Vp-p, 75 ohm, negative sync. C-INPUT: 0.3Vp-p (burst signal), 75 ohm VIDEO 1/VIDEO 2/VIDEO 3 INPUT VIDEO: 1Vp-p, 75 ohm, negative sync. AUDIO: 150mVrms. (30% modulation, 47k ohm) AUDIO/VIDEO OUTPUT VIDEO: 1Vp-p, 75 ohm, negative sync. AUDIO: 150mVrms. (30% modulation, 4.7k ohm) VARIABLE AUDIO OUTPUT 0~350mVrms. (30% modulation, 4.7k ohm)
DIMENSIONS:	Width 31-7/64 inches (790mm) Height..... 29-29/64 inches (748mm) Depth 22-53/64 inches (580mm)
WEIGHT:	150lbs (68kg)
SUPPLIED ACCESSORIES:	1. Remote Control Unit with 2 size "AAA" batteries 2. Antenna adapter

BEFORE CALLING SERVICE PERSONNEL

Before calling service personnel, please check the following chart for a possible cause of the problem you are experiencing. A minor adjustment on your part may eliminate the problem and restore your TV reception.

Symptoms	Check these things	Try-these adjustments
● No picture, no sound	<ul style="list-style-type: none"> ● Be sure power cord is plugged in ● May be station trouble ● Check antenna connections ● Check antenna for broken wires 	<ul style="list-style-type: none"> ● Press POWER button ● Try another channel
● No UHF, VHF OK	<ul style="list-style-type: none"> ● Be sure TV/CATV function is in "TV" mode 	
● No sound, picture OK	<ul style="list-style-type: none"> ● May be station trouble ● Check if SPEAKER ON/OFF function or SPEAKER SELECT switch is properly set 	<ul style="list-style-type: none"> ● Try another channel ● Adjust VOLUME
● Poor sound, picture OK	<ul style="list-style-type: none"> ● May be station trouble ● Check antenna connections ● May be local interference from appliance 	<ul style="list-style-type: none"> ● Try another channel ● Adjust VOLUME ● Adjust BASS, TREBLE, or BALANCE control ● Re-orient antenna
<ul style="list-style-type: none"> ● Poor picture, sound OK Snowy picture Lines in picture Distorted picture Weak picture 	<ul style="list-style-type: none"> ● May be local interference from appliance ● Check antenna connections ● Check antenna for broken wires ● May be station trouble 	<ul style="list-style-type: none"> ● Try another channel ● Adjust BRIGHTNESS ● Adjust CONTRAST ● Adjust SHARPNESS ● Re-orient antenna
● Poor reception of broadcast channels	<ul style="list-style-type: none"> ● Check antenna connections ● Check antenna for broken wires ● If VCR is connected, check TV/VCR switch 	<ul style="list-style-type: none"> ● Try another channel ● Re-orient antenna
● Unable to select a certain channel	<ul style="list-style-type: none"> ● That channel may be locked out with parental control feature 	
● Multiple images (ghosts)	<ul style="list-style-type: none"> ● May be station trouble ● Check antenna connections 	<ul style="list-style-type: none"> ● Try another channel ● Re-orient antenna
● Poor color or No color	<ul style="list-style-type: none"> ● May be station trouble ● Check antenna connections ● Check antenna for broken wires ● May be local interference from appliance ● Check if station is broadcasting in color 	<ul style="list-style-type: none"> ● Try another channel ● Re-orient antenna ● Adjust TINT ● Adjust COLOR
● Weak and noisy stereo program	<ul style="list-style-type: none"> ● Check antenna connections ● Check antenna for broken wires 	<ul style="list-style-type: none"> ● Re-orient antenna ● Try pressing MTS button in Mono mode
● No stereo or SAP sound from a known MTS broadcast	<ul style="list-style-type: none"> ● Check if MTS button is properly set 	
● Remote control does not work	<ul style="list-style-type: none"> ● Check if VCR/CABLE/TV SW. is properly set ● Be sure power cord is plugged in ● Check battery in Remote Control Unit 	<ul style="list-style-type: none"> ● Change batteries

NOTES

NOTES

KENWOOD

23561429

Free Manuals Download Website

<http://myh66.com>

<http://usermanuals.us>

<http://www.somanuals.com>

<http://www.4manuals.cc>

<http://www.manual-lib.com>

<http://www.404manual.com>

<http://www.luxmanual.com>

<http://aubethermostatmanual.com>

Golf course search by state

<http://golfingnear.com>

Email search by domain

<http://emailbydomain.com>

Auto manuals search

<http://auto.somanuals.com>

TV manuals search

<http://tv.somanuals.com>