

KENWOOD

DIGITAL AUDIO PLAYER

M2GD55
M1GD50

INSTRUCTION MANUAL

Kenwood Corporation



© B60-5704-08 /01 (E)

Download from www.Somanuals.com. All Manuals Search And Download.

ENGLISH

FRANÇAIS

DEUTSCH

NEDERLANDS

ITALIANO

ESPAÑOL

Contents

Safety precautions	3
Unpacking	5
Flow for music playback.....	5

Read Before Use

Names and functions of parts	6
Screen display items	7

For first use

Connecting stereo headphones.....	8
Selecting the ear tips.....	8
Switching Power ON/OFF	8
HOLD function	8
Recharging Battery/ Connecting a PC.....	9
Recharging Battery.....	9
Recharging and battery indication.....	9
Connecting a PC.....	9
PC system configuration requirements ..	9
Disconnecting the Player from the PC... 10	
When the connection mode is MTP	
mode	10
When the connection mode is MSC	
mode	10
Capturing Music in PC.....	11
The Player can play the following 2 types	
of music files.....	11
Using Windows Media Player 11/10/9... 11	
Transferring Music from PC	13
Using Windows Media Player 11/10/9... 13	
Data transfer by drag & drop	14
Deleting tracks.....	15
Using Windows Media Player 11/10/9... 15	
Formatting.....	16
When the connection mode is MTP	
mode	16
When the connection mode is MSC	
mode	16

Playing music tracks

Selecting music for playback.....	17
Display during playback	18
Number of tag information display	
characters.....	18
Operations available during playback ... 18	
Various play modes	19

Adjusting the audio

Adjusting the audio	21
Adjusting the volume.....	21
Selecting the sound effects.....	21

Setting and adjusting the Player

Sleep timer	22
Various setups	23
Function items that can be set	23
Setting the menu language.....	24
Initialization.....	25

Appendix

Connection of external components	26
Connecting to the headphones jack.....	26
Connecting to the USB connector.....	26
Digital Audio Player Link.....	27
Glossary	28
Error messages.....	28
Troubleshooting.....	29
Specifications.....	30
Notes on Disposal.....	31
Recycling the Built-in Battery	31
Removing the Rechargeable Battery	
(Built-in Battery) Before Disposal:	
M2GD55	31
Removing the Rechargeable Battery	
(Built-in Battery) Before Disposal:	
M1GD50	32

Safety precautions

IMPORTANT SAFETY INSTRUCTIONS

Caution:

Read this page carefully to ensure safe operation.

Read Instructions – All the safety and operating instructions should be read before the product is operated.

Retain Instructions – The safety and operating instructions should be retained for future reference.

Heed Warnings – All warnings on the product and in the operating instructions should be adhered to.

Follow Instructions – All operating and use instructions should be followed.

WARNING :

• **Do not use headphones during riding/driving a vehicle or walking.**

Otherwise, a traffic accident may result. Never use headphones when you ride a bicycle or driving an automobile or motorbike. If the Player is used during walking, the ambient sounds will be cut and you may have difficulties in hearing various warning sounds.

• **Do not operate the Player during riding or driving a vehicle.**

Do not operate the Player when you drive or ride an automobile, motorbike or bicycle. Otherwise, a traffic accident may result. Be sure to stop the vehicle in a safe place before operating the Player.

• **Do not stare at the display screen during riding or driving a vehicle.**

Otherwise, a traffic accident may result.

• **Do not leave the ear tips provided with the Player in the reach of children.**

There has been a case in which a child swallowing a small item was suffocated to death. If a child swallows an ear tip by accident, immediately take the emergency measure to let the child vomit it out and see a doctor.

Precautions :

- Do not insert or drop a metallic object or an easily flammable object inside the Player through an opening. Otherwise, a fire hazard or battery leak may result.
- When connecting ancillary equipment to the Player, read the instruction for the equipment, switch the Player off and connect the equipment as instructed. Also be sure to use the specified cord for the connection. Inappropriate connection, use of a non-specified cord or extension of the cord may cause heat generation and a burn or other injuries.

Do not use or place the product in the following locations:

- A place with high humidity, such as in a bathroom or shower room. Also do not use the Player in a place subject to water splashes. Otherwise, a fire hazard or battery leak may result.
- Do not approach the Player to heating equipment (a stove, iron, etc.). Otherwise, a fire hazard or battery leak may result.
- Do not place the Player in a place subject to soot or vapor, for example in a kitchen or near an air humidifier, or in a place subject to excessive humidity or dust. Otherwise, a fire hazard or battery leak may result.
- Do not leave the Player in a place where the temperature may rise abnormally high, for example in a closed automobile or under direct sunlight. Otherwise, the Player or its parts may deteriorate or a fire hazard or battery leak may result.

Notes on using through headphones:

- Do not start listening with too high a volume. Otherwise, sudden output of a high-volume sound may cause hearing failure, etc.
- Do not listen to the audio with an extremely high volume for long hours. Otherwise, your hearing ability may be damaged.
- Do not use headphones if an abnormality is felt on the skin. Otherwise, skin inflammations may result. Should any abnormality be felt on the skin or ears during use of headphones, immediately stop using them and see a doctor.
- A person with an ear disease is discommended to use headphones. Otherwise, the disease may worsen. Should any abnormality be felt on the skin or ears during use of headphones, immediately stop using them and see a doctor.
- Be sure to attach the ear tips firmly. If the ear tips are attached insufficiently to the headphones, an ear tip may drop out, enter the deep of the ear and injure it. Should an ear tip drop out inside an ear, see a doctor.
- Attach and detach headphones around the ears gently and slowly. Violent attaching or detaching may injure the ear.

Notes on using through car stereo :

- Do not leave the products or batteries in the car, particularly above the dashboard, for this may lead to malfunction or damage due to solar heat.
- If the unit is connected to a car stereo using an audio cord, noise may sometimes interfere.

Safety precautions

Handling

- Do not apply an excessive force to the display part. Otherwise, it may be damaged.
- Avoid storing the player in a bag together with a hard object. Otherwise, the player may be damaged when the bag is pushed.
- Do not expose the player to an insecticide or other volatile substance or bring the player in extended contact with a rubber or vinyl material. Otherwise, discoloration or peeling of the surface finish may result.
- Do not put the player in a pocket of trousers. Otherwise, it may be damaged due to a strong impact when you sit down, etc.
- **Protect the player against sweat and moisture.**
Do not use the player by putting it in a breast pocket for long hours in the summer or during exercise. Otherwise, penetration of moisture or sweat may cause malfunction or failure.

Operating conditions

Temperature: 5 to 35°C. (without condensation)

Caution on condensation

Condensation (of dew) may occur inside the unit when there is a great difference in temperature between this unit and the outside. This unit may not function properly if condensation occurs. In this case, leave the unit for a few hours and restart the operation after the condensation has dried up.

Be specially cautious against condensation in the following circumstances:

When this unit is carried from one place to another across a large difference in temperature, when the humidity in the room where this unit is installed increases, etc.

Maintenance of the unit

When the front panel or case becomes dirty, wipe with a soft, dry cloth.

Do not use thinner, benzene, alcohol, etc. for these agents may cause discoloration.

In regard to contact cleaner

Do not use contact cleaners because it could cause a malfunction. Be specially careful not to use contact cleaners containing oil, for they may deform the plastic component.

Note on the built-in battery

- For the replacement of the built-in battery, contact your dealer.
- The battery built into the player discharges spontaneously even when the player is not used. This means that the built-in battery may be exhausted completely when the player is left unused for a long period. If this happens, recharge the battery before using the player.
- The battery recharging time is variable depending on the condition of the battery and ambient temperature.
- The available playback time reduces when the player is used under low temperatures.
- The built-in battery can be recharged for about 500 times. (This is a reference value and is not guaranteed.)
- The built-in battery is a consumable part, and the available playback time reduces gradually after repeated use. If the available playback time becomes very short even after the battery has been recharged fully, the battery may be degraded; replace it with new one.
- Kenwood will not assume any liabilities for the alteration or loss of data caused due to complete discharging of the built-in battery.
- The built-in battery is a lithium ion battery.
It is free from the memory effect of Ni-Cad and nickel-hydrogen batteries, with which the capacity decreases if the battery is charged or discharged incompletely for several times. The built-in battery therefore accepts additional charging before it has exhausted completely.

Unpacking

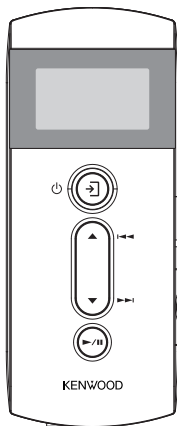

Player (M1GD50)

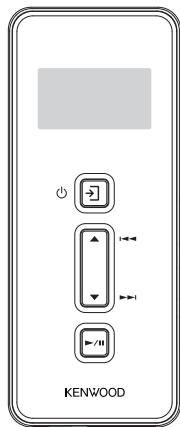

Player (M2GD55)

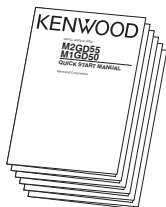

Quick start manual

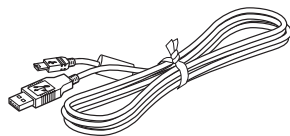

USB cable



Headphones
(Ear tip: M size)



Ear tip (L size, S size)

Flow for music playback

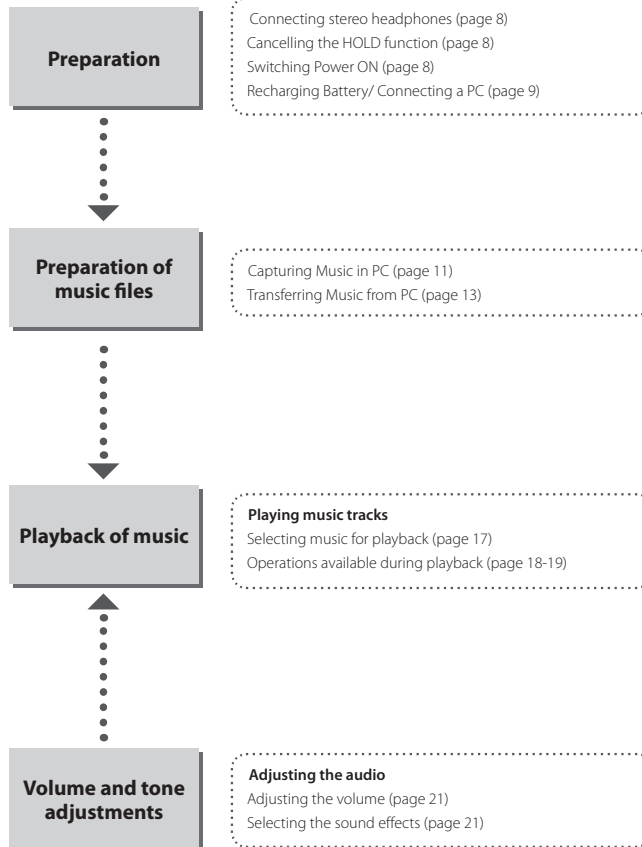

Names and functions of parts

M1GD50

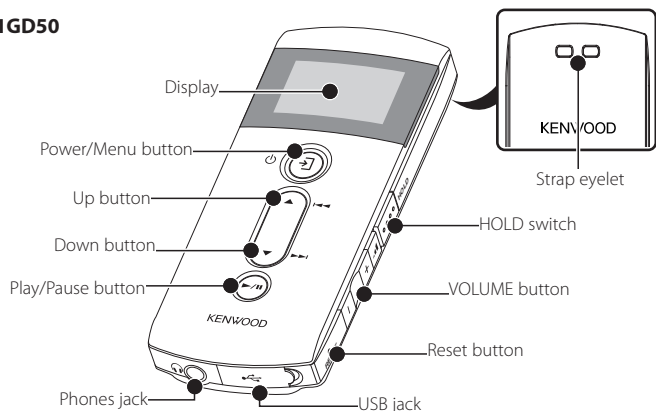

M2GD55

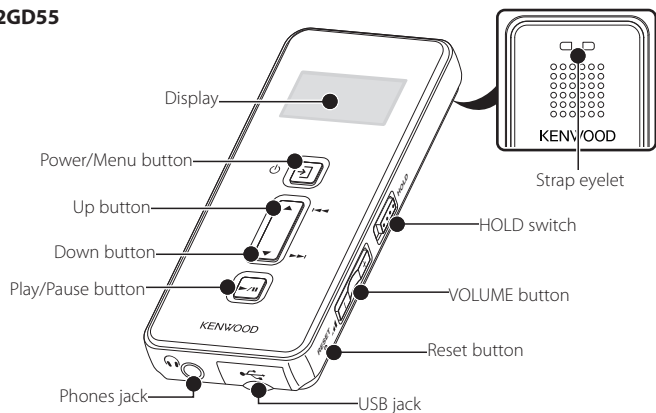

• Do not pass a metallic hook or like (a key holder, etc.) through the strap eyelet. Otherwise, the player may be damaged.

Power/Menu button

- Press and hold to switch the power ON/OFF.
- Press shortly to open the menu.
- Press shortly while the menu is open to return to the previous display page.
- Press when the display is turned off (screen saver mode) to turn on the display.
- Status indicated by the indicator

	During play	During USB connection
Steady lighting	Power is ON.	Recharging...
One blink per 3 sec.	Screen saver mode.	—
Two blinks per 3 sec.	Screen saver mode under Hold function activated.	—
Blink	—	Transferring data...
Extinguished	Power is OFF.	Recharging completed.

▲ Up button

- Press to move the cursor upward.
- Press during playback to skip to the beginning of the current track. Pressing the button at the beginning of a track skips to the beginning of the previous track.
- Press and hold to fast reverse the track.

▼ Down button

- Press to move the cursor downward.
- Press during playback to skip to the beginning of the next track.
- Press and hold to fast forward the track.

▶/|| Play/Pause button

- Press to play a track or let it pause.
- During playback, press and hold for more than 1 second to set the A-B Repeat points.
- Press while the menu is displayed to enter a selected item.

▲/▼ VOLUME button

- Press to increase (+) or decrease (-) the volume. Pressing and holding a button segment varies the volume gradually.

HOLD switch

- Press to defeat all other buttons. This helps prevent erroneous operation of the Player when it is carried in a bag, etc.

Phones jack

- Connect the provided stereo headphones.

USB jack

- Connect to a PC using the provided USB cable to transfer music files or recharge the battery.

Strap eyelet

- Pass the strap through this hole.

Reset button

- In case of irregularity, first consult <Troubleshooting> (page 29). If an optimum remedy is not found, try pressing the reset button with the tip of a clip or ballpoint pen.



Screen display items

Home screen

This is the initial display page for use in selection of the music selection method and in various setups.



Settings menu screen

Menu screen for use in various settings including the tone adjustment and playback modes.

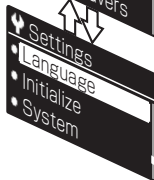
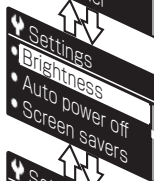

Control buttons

Cursor movement



Screen switching



Sound mode (page 21)

Normal, Bass, Pops, Rock, Jazz, Dance, Voice

Play mode (page 19)

Normal, Repeat all, Repeat one, Random, Repeat random

Sleep timer (page 22)

Off, 10Min, 20Min, 30Min, 40Min, 50Min, 60Min

Brightness (page 23)

High, Mid, Low

Auto power off (page 23)

1Min, 3Min, 5Min, 10Min

Screen savers (page 23)

3Sec, 5Sec, 10Sec, 30Sec, 60Sec

Language (page 24)

ENGLISH, 日本語, DEUTSCH, FRANCAIS, ESPAÑOL, ITALIANO, NEDERLANDS

Initialize (page 25)

No, Yes

System (page 23)

USB connecting message screen

Message screen indicating that the Player is connected to a PC (page 9).



Library screen

This is the music selection display page with 4 types of selecting method. (page 17)

Selecting "Play all" during playback starts playback of all the music tracks belonging to the last selected item.

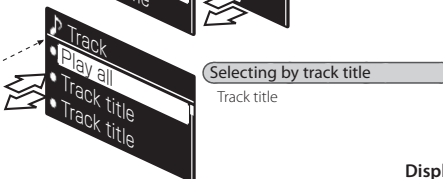
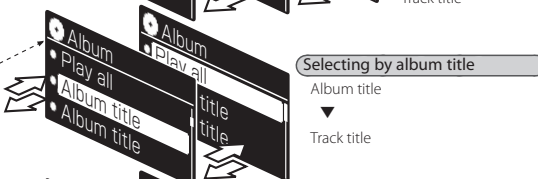

Display during playback (page 18)

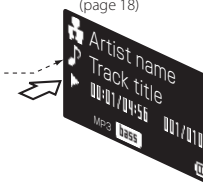

Connecting stereo headphones

Connect the provided stereo headphones to the Player.

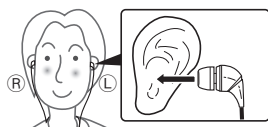
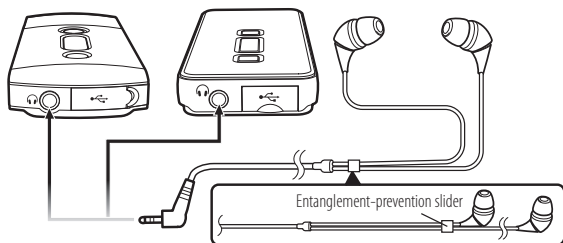

Hold the headphone body and insert into each ear. The optimum condition is when the ear hole is stopped completely by the ear tip.

Selecting the ear tips

The headphones are shipped from the factory with the M-size ear tips attached. If the M-size ear tips do not match your ears, replace them with the provided S-size or L-size ear tips.

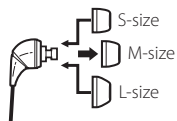

- Always hold the headphone bodies when attaching or detaching headphones. Pulling a cord may result in malfunction.
- To clean the ear tips, remove them from the headphone bodies and wash with a neutral detergent solution. After washing, wipe them dry before use.
- The ear tips may deteriorate after a long period of use or storage.
- To prevent the headphone cord from being entangled, slide the entanglement-prevention slider to fix the headphone bodies in position.

Switching Power ON/OFF

1 Switch the Player ON.



Press and hold the Power/Menu button until the KENWOOD logo is displayed.
The Player enters the mode before the last time it was switched OFF.

2 Switch the Player OFF.



Press and hold the Power/Menu button until the pattern shown on the left is displayed.



- The display is turned off automatically when the Player has not been operated for a certain period of time (screen saver mode). The Power/Menu button blinks every 3 seconds in the screen saver mode. The time until the screen saver mode is activated can be changed (page 23).

HOLD function

The HOLD function defeats all of the Player's buttons and helps prevent erroneous operation when the Player is carried in a bag, etc.

The HOLD function should be canceled before using the Player.

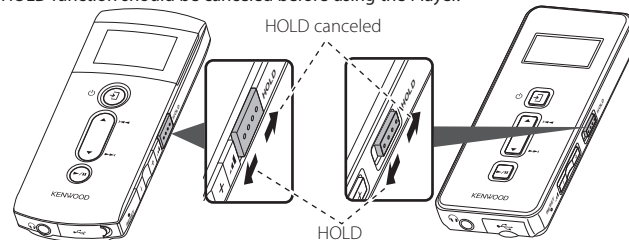

- When the HOLD function is switched on and the display is in the screen saver mode, the Power/Menu button blinks twice every 3 seconds. is displayed when the display is turned on.

Recharging Battery/ Connecting a PC

The Player incorporates a rechargeable battery (hereinafter referred to as "the battery"), which can be recharged by connecting the Player to a PC through a USB cable.

Recharging Battery

Open the USB cover.

Using the provided USB cable, connect the Player to a PC.

Recharging is complete when the indicator of the Power/Menu button turns off.

Recharging completes in about 3.5 hours.

The method for disconnection from the PC after recharging is variable depending on the connection mode. For details, see <Disconnecting the Player from the PC> (page 10).

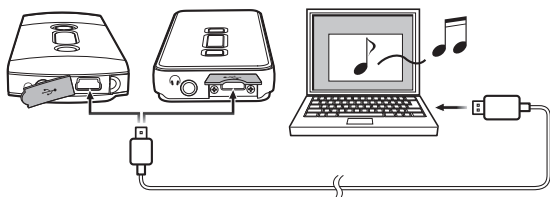

- Start up the PC before connecting the Player.
- The Player is switched ON automatically at the moment it is connected to the PC.
- When the USB connection, always use a supplied USB cable.
- The player should be connected directly to the USB port of the PC. We cannot guarantee the operation if the player is connected via a USB hub.

Recharging and battery indication

On-screen icons

	Shows the remaining power of the battery.
	Indications during recharging.
	The battery is nearly exhausted. Recharge it if it is rechargeable.
	The battery is not inserted or not rechargeable.

Power/Menu button's indicator (during USB connection)

ON	The indicator lights during recharging.
OFF	The indicator is extinguished when recharging completes.
Blink	Data is being transferred between the player and the PC.

Connecting a PC

Connect the Player to a PC to transfer music from the PC to the Player and to recharge its battery.

The connection mode varies according to the OS running on the PC and the version of Windows Media Player.

OS	Windows Media Player			Windows Media Player not installed
	11	10	9	
Windows Vista	MTP	—	—	MSC
Windows XP (SP1/SP2)	MTP	MTP	MSC	MSC
Windows 2000	—	—	MSC	MSC



- When the OS is Windows XP, it is recommended to patch Service Pack 2. The descriptions in this manual assume that Service Pack 2 is used.
- Update the OS and Windows Media Player to the latest conditions by means of the Windows Update facility.

PC system configuration requirements

OS	Microsoft® Windows® Vista/XP/2000
USB connector	Compliant to USB 1.1/2.0 (Full Speed) standard



- All of the above specified PC environment does not guarantee full operation of the Player.
- Not supported by 64 bit version OS.
- Use a PC in which either OS mentioned above is preinstalled. Operation is not guaranteed on a PC running an upgraded OS or a PC assembled by yourself.

Disconnecting the Player from the PC

When the connection mode is MTP mode

(When "Kenwood M_D5*" or "M_D5*" is displayed on Windows)

1 Unplug the USB cable from the Player.

Ensure that the indicator of the Power/Menu button is not blinking before unplugging the USB cable.

When the connection mode is MSC mode

(When "KENWOOD_DAP" is displayed on Windows)

1 Click the [Safe To Remove Hardware] icon.



Display the indicator on the task tray if it is not displayed.



Windows Vista



Windows XP



Windows 2000

2 Click [Safely remove USB Mass Storage Device].



When the message showing that the Player can be disconnected safely, disconnect it from the PC.

Capturing Music in PC

To play music files as tracks of this Player, first rip music files in the PC.

The Player can play the following 2 types of music files.

- MP3 (*.mp3) : MPEG-1 Audio Layer-3

Sampling frequency	32/ 44.1/ 48 KHz
Transfer bit rate	16k – 320 kbps
Variable Bit Rate (VBR)	16k – 320 kbps
ID3 tag	Ver. 2.2/ 2.3/ 2.4

- WMA (*.wma) : Windows Media Audio

Sampling frequency	32/ 44.1/ 48 KHz
Transfer bit rate	32k – 320 kbps
Variable Bit Rate (VBR)	32k – 355 kbps

Using Windows Media Player 11/10/9

A music CD can be ripped into the PC using the Windows Media Player 11/10/9.

(The following steps describes the operation with the Windows Media Player 11/10.)

Using Windows Media Player 11

1 Launch the Windows Media Player.

2 Click the [Rip] button on the top.



3 Place a music CD in the CD-ROM driver of the PC.

4 Check the checkboxes of the CD tracks to be ripped.

Checking the checkbox at the top of the list checks or unchecks all the track names listed below it.

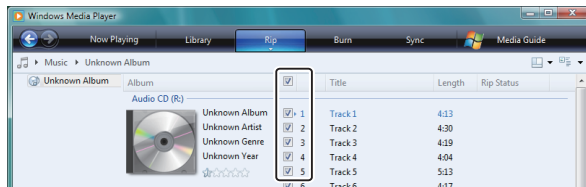

5

Click the [Start Rip] button.

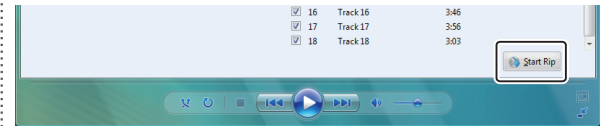

When the [Rip Option] dialog box is displayed:

Select "Do not add copy protection to your music", check "I understand that music... I have copied." and then click [OK].



- For the operating procedures of software including the Windows Media Player, refer to the manuals and help information for the software.
- If copy protection is set, when capturing tracks of a music CD into the PC using the Windows Media Player, transferring the music file to the Player is limited only to the Windows Media Player. The music files which are transferred using drag & drop or copy & paste cannot be played.
- Before transferring a music file, view it with the Windows Media Player to confirm that the genre, artist name, album title and track title are set correctly.
- For selecting a destination folder or a file format, go to [Tools] menu > [Options] > [Rip Music] tab.

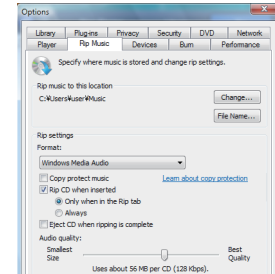
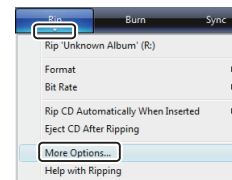

Using Windows Media Player 10

1 Launch the Windows Media Player.

2 Click the [Rip] button on the top.

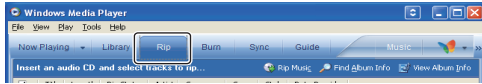

3 Place a music CD in the CD-ROM driver of the PC.

4 Check the checkboxes of the CD tracks to be ripped.

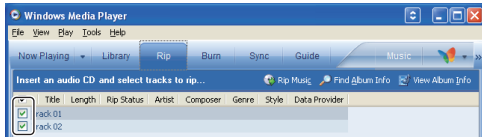

5 Click the [Rip Music] button.

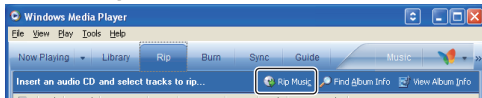

• For selecting a destination folder or a file format, go to [Tools] menu > [Options] > [Rip music] tab.

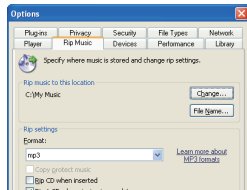

Transferring Music from PC

The obtained music files can then be transferred to the Player.

Using Windows Media Player 11/10/9

(The following steps describes the operation with the Windows Media Player 11/10)

Using Windows Media Player 11

1 Connect the Player to a PC.

2 Launch the Windows Media Player.

3 Set up the device.

When MTP: [Kenwood M_D5*] or MSC: [KENWOOD_DAP] device name is displayed, click [Finish].

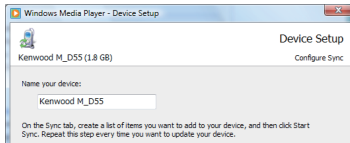

When the [Device Setup Manage Existing Files on Device] dialog box is displayed:

Search for the music files to be added to the library.

4 Click the [Sync] button on the top.

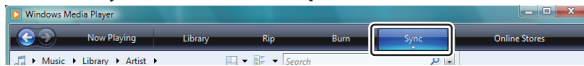

5 Select the MTP player (Kenwood M_D5*) or the removable disk (KENWOOD_DAP) corresponding to this Player.

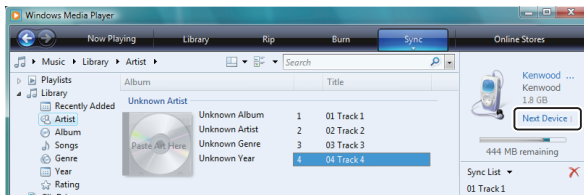

5 Add the music files to be transferred in the Sync List.

Drag & drop the music file selected from the library into the sync list on the right. Alternatively, right-click to open a pop-up menu and select [Add to 'Sync List'] from it.

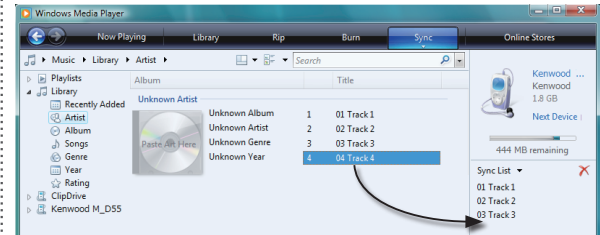

6 Click the [Start Sync] button.

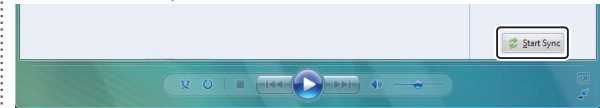

Using Windows Media Player 10

1 Connect the Player to a PC.

2 Launch the Windows Media Player.

3 Click the [Sync] button on the top.

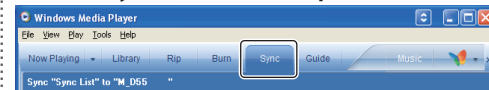

- 4** Select the MTP player (M_D5*) or the removable disk (KENWOOD_DAP) corresponding to this Player.

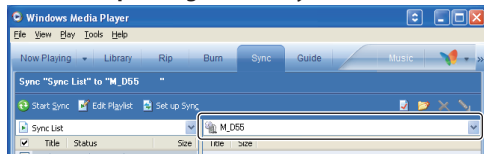

- 5** Add the music files to be transferred in the Sync List.

- 6** Click the [Start Sync] button.

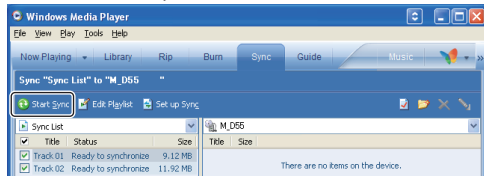

Data transfer by drag & drop

Open the Windows Explorer and drag & drop the desired file from the PC's hard disk drive to this Player (expressed as MTP: [Kenwood M_D5*], [M_D5*] or MSC: [KENWOOD_DAP] on Windows). Copy & paste can also be used for data transfer.

- 1** Open the MTP player or the removable disk corresponding to this Player.

Click [Start] – [Computer] – MTP: [Kenwood M_D5*], [M_D5*] or MSC: [KENWOOD_DAP].

- 2** Open the folder storing the desired music file.

- 3** Drag & drop the music file into the MTP player or the removable disk.

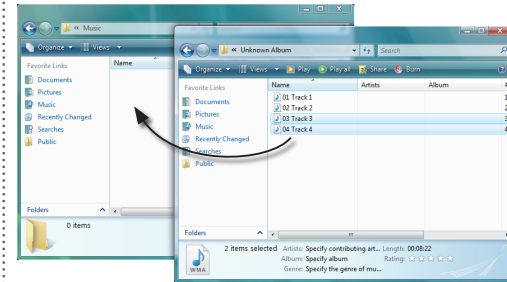

Deleting tracks

The music files transferred from the PC to the Player can be deleted from the Player.

Using Windows Media Player 11/10/9

(The following steps describes the operation with the Windows Media Player 11/10)

Using Windows Media Player 11

- 1 **Connect the Player to a PC.**
- 2 **Launch the Windows Media Player.**
- 3 **Click the [Sync] button on the top.**
- 4 **Select the MTP player (Kenwood M_D5*) or the removable disk (KENWOOD_DAP) corresponding to this Player.**
- 5 **Select the music file to be deleted, right-click to open a pop-up menu, and select [Delete] from it.**

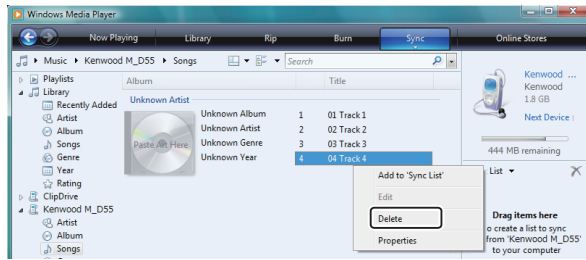

Using Windows Media Player 10

- 1 **Connect the Player to a PC.**
- 2 **Launch the Windows Media Player.**
- 3 **Click the [Sync] button on the top.**
- 4 **Select the MTP player (M_D5*) or the removable disk (KENWOOD_DAP) corresponding to this Player.**
- 5 **Click the [Delete] icon.**

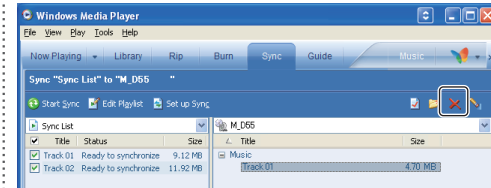

Formatting

Formatting can be used to delete all of the music and other files stored in the Player.

Caution

- Formatting deletes all of the files in the Player. It also deletes demonstration music, which cannot be restored later. It does not alter the settings made with the Settings menu.
- Once formatted, the memory cannot be restored to the previous condition. Be cautious when performing formatting.

When the connection mode is MTP mode

(When "Kenwood M_D5*" or "M_D5*" is displayed on Windows)

Using Windows Media Player 11

- 1 **Connect the Player to a PC.**
- 2 **Launch the Windows Media Player.**
- 3 **Click the [Sync] button on the top.**
- 4 **Select the MTP player (Kenwood M_D5*) corresponding to this Player.**
- 5 **Click the arrow below the [Sync] tab to open a menu, and select [Kenwood M_D5*] – [Format].**

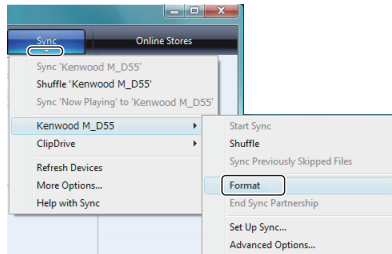

Using Windows Media Player 10

- 1 **Connect the Player to a PC.**
- 2 **Launch the Windows Media Player.**
- 3 **Click the [Sync] button on the top.**
- 4 **Select the MTP player (M_D5*) corresponding to this Player.**
- 5 **Click the [Format] icon.**

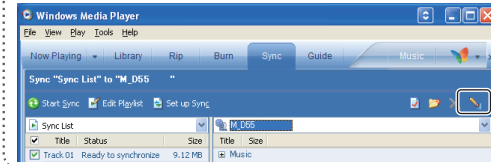

When the connection mode is MSC mode

(When "KENWOOD_DAP" is displayed on Windows)

- 1 **Connect the Player to a PC.**
- 2 **Open the removable disk corresponding to this Player.**
Click [Start] – [Computer] – [KENWOOD_DAP].
- 3 **Format the Player.**



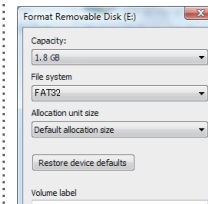

Right-click to open a pop-up menu, and select [Format] from it.



File system
: FAT32
Allocation unit size
: Default allocation size

Selecting music for playback

Select and play the desired track.

	Artist	Select Artist name → Album title → Track title.
	Album	Select Album title → Track title.
	Genre	Select Genre name → Track title.
	Track	Select Track title directly.

When a major item is selected, the list of intermediate items located below it is displayed. Selecting "Play all" plays all of the currently selected music tracks. When a track is selected from "Artist" or "Album", the tracks are played in order of track numbers. When a track is selected from "Genre" or "Track", the tracks are played in order of track titles.

- 1** **Connect headphones and switch the Player ON.**
See page 8.
- 2** **Open the home screen.**
The home screen opens.

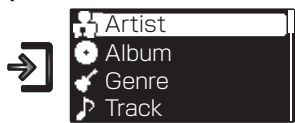

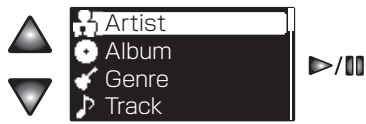
- 3** **Select a major item ("Artist", for example).**
The list for the major item (intermediate items) is displayed.

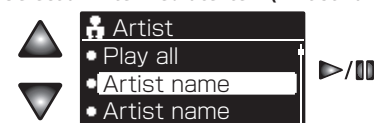

- 4** **Select an intermediate item ("Artist name", for example).**
The list for the intermediate item is displayed.

- 5** **Select an intermediate item ("Album title", for example).**
The list for the intermediate item is displayed.

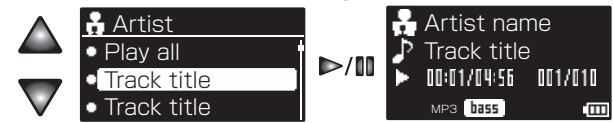

- 6** **Select a track ("Track title", for example).**



- MEMO**
- A track that does not contain tag information is classified as "Unknown".
 - The music tracks are played back in either order described below.
 - Track number: Order of track numbers in the tag information. When there is no track number, the tracks are played in order of track titles or file names.
 - Track title: Order of track titles or file names in the tag information.
 - Press the Menu button to return to the previous display page.

Display during playback

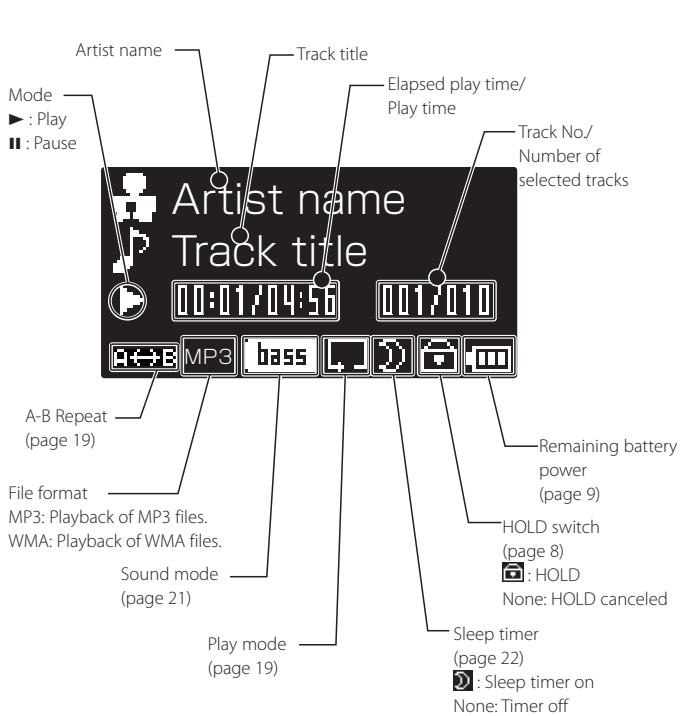
The display shows various information during playback.



Number of tag information display characters

The following table shows the maximum number of characters that the Player can use to display each item of tag information.

Tag information	Artist name	Album title	Track title	Genre
Number of characters	46	44	78	18



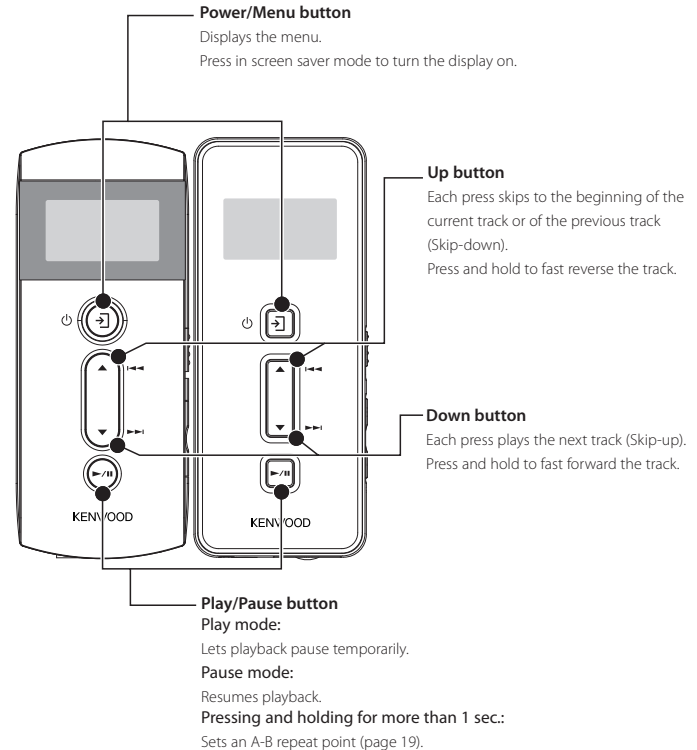



Operations available during playback



• The Player switches OFF automatically after it has been left in pause mode for a certain period of time (Auto power-off). The time until Auto Power-OFF occurs can be changed (page 23).

Various play modes

One of the following six play modes can be selected.

	Normal	Playback stops after having played the tracks in the list.
	Repeat all	Playback of all of the tracks in the list repeatedly.
	Repeat one	Playback of the same track repeatedly.
	Random	Playback of all of the tracks in the list in a random order, playing every track once.
	Repeat random	Repeated playback of all of the tracks in the list in a random order.
	A-B Repeat	Repeat playback of the section between points A-B set within a track.

The tracks in the list vary depending on the item used for selecting the track being played. (page 17)

Modes other than "A-B Repeat"

- 1** **Open the home screen.**



The home screen opens.
- 2** **Select "Settings".**

- 3** **Select "Play mode".**

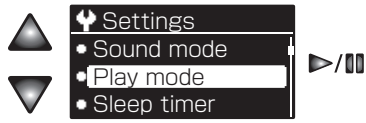

4 **Select the desired play mode.**

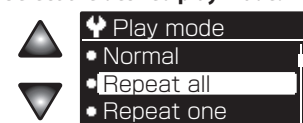

The display during playback resumes in about 30 seconds.

MEMO Press the Menu button to return to the previous display page.

To select "A-B repeat"

- 1** **Advance music until the point you want to set as the A-B Repeat start point.**

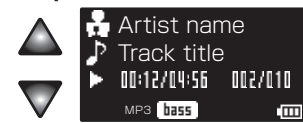

Press and hold the Up or Down button to fast forward or fast reverse the music.
- 2** **Set the start point (point A).**

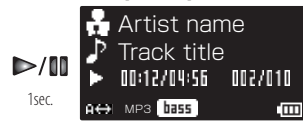

After pressing and holding the button for more than 1 second, release the button. "A<=>" is displayed. Even during pause, the start point can be set by pressing and holding the button for more than 1 second.
- 3** **Advance music until the point you want to set as the A-B Repeat end point.**

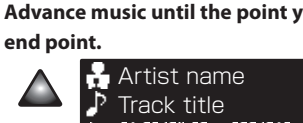

Press and hold the Up or Down button to fast forward or fast reverse the music. If the blank between tracks is reached, the A-B Repeat setting is canceled.

Various play modes

4 Set the end point (point B).

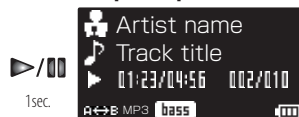

After pressing and holding the button for more than 1 second, release the button. "A↔B" is displayed. Even during pause, the end point can be set by pressing and holding the button for more than 1 second.

5 To cancel A-B Repeat.



Adjusting the audio

Adjusting the volume

Adjust the listening volume as follows.

1 Select the volume level.

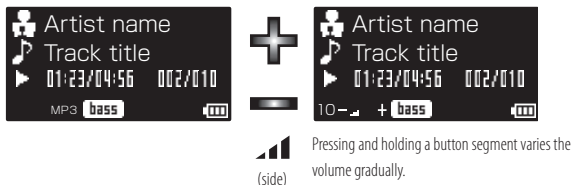

Selecting the sound effects

Select one of the 7 modes.

	Normal	Playback in normal tone.
bass	pops	Bass/ Pops/ Playback in a tone matching the genre of music.
rock	jazz	Rock/ Jazz/
dance	voice	Dance/Voice

1 Open the home screen.



2 Select "Settings".

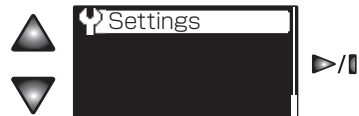

3 Select "Sound mode".



4 Select the desired sound mode.



- If the headphone volume is increased too much, you will be unable to hear the sounds from outside. Be careful not to increase the volume too much.
- With the default condition set at the factory, Sound mode is set to "Normal".
- Press the Menu button to return to the previous display page.

Sleep timer

The sleep timer makes it possible to switch the Player OFF after the set period of time.

- 1 Open the home screen.**

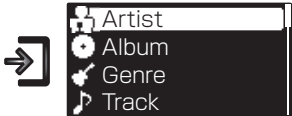

The home screen opens.
- 2 Select "Settings".**

- 3 Select "Sleep timer".**

- 4 Select the timer to be set.**



The sleep timer period can be set in 10-minute steps between 10 and 60 minutes.

The display during playback resumes in about 30 seconds.



- To deactivate the timer, select "Off" in step 4.
- The timer setting is canceled when the Player is switched OFF.
- Press the Menu button to return to the previous display page.

Various setups

The functions such as the button illuminations, display resume function and Auto Power OFF function can be set up as required.

- 1 Open the home screen.**

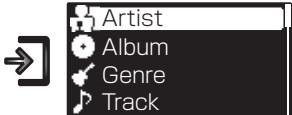

The home screen opens.
- 2 Select "Settings".**

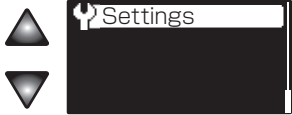
- 3 Select the item to be set.**



To decrease the display brightness, for example, select "Brightness" to view its options.
- 4 Select the desired option.**



After the desired option is set, the Settings menu appears again.

The display during playback resumes in about 30 seconds.



• Press the Menu button to return to the previous display page.

Function items that can be set

- Sound mode**
Playback in a tone matching the genre of music.
Refer to <Selecting the sound effects> (page 21).
- Play mode**
One of the following six play modes can be selected.
Refer to <Various play modes> (page 19).
- Sleep timer**
The sleep timer makes it possible to switch the Player OFF after the set period of time.
Refer to <Sleep timer> (page 22).
- Display brightness (Brightness)**
Select the brightness level of the display panel.

High	High
Mid*	Medium
Low	Low

(* indicates the factory setting.)
- Auto power off**
Select the time until the Player is switched OFF when no operation including playback is performed.

1 min/ 3 min/ 5 min*/ 10 min

(* indicates the factory setting.)
- Display power-save setting (Screen savers)**
Select the time until the display is turned off when no operation is performed.

3 sec/ 5 sec/ 10 sec*/ 30 sec/ 60 sec

(* indicates the factory setting.)
- Language**
Select the language used for the displayed menus, etc.

ENGLISH/ 日本語/ DEUTSCH/ FRANCAIS/ ESPAÑOL/ ITALIANO/ NEDERLANDS
--

(* indicates the factory setting.)
- Initialize**
Initialization resets the settings made using the Settings menu, etc. to the default settings made at the factory.
Refer to <Initialization> (page 25).
- System information (System)**
The system information of the Player (total memory capacity, available memory capacity and version No.) is displayed. Press the Play/Pause button to hide the system information display.

Setting the menu language

Select the language used for the display.

- 1 Open the home screen.**

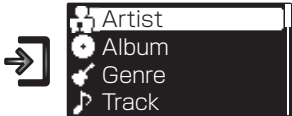

The home screen opens.
- 2 Select "Settings".**

- 3 Select "Language".**

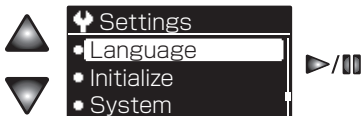
- 4 Select the desired language.**



The display during playback resumes in about 30 seconds.



• Press the Menu button to return to the previous display page.

Initialization

Initialization resets the settings made using the Settings menu, etc. to the default settings made at the factory.

Caution

- Initialization resets the Settings menu to the default settings. It does not delete music files, etc.

- 1 Open the home screen.**

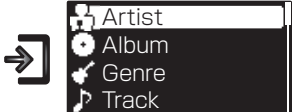

The home screen opens.
- 2 Select "Settings".**

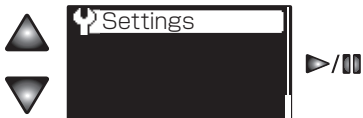
- 3 Select "Initialize".**

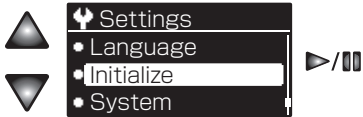

4

Select "Yes".



- Even after the Player is reset, the tracks stored in it are not deleted. Deletion of individual tracks (page 15) and formatting (page 16) of the Player should be executed from the PC.
- Press the Menu button to return to the previous display page.

Connection of external components

The headphone jacks can be used to connect an external component such as a speaker with built-in amplifier.

The USB connector can be used to connect an external component such as a stereo set with USB capability.

Connecting to the headphones jack

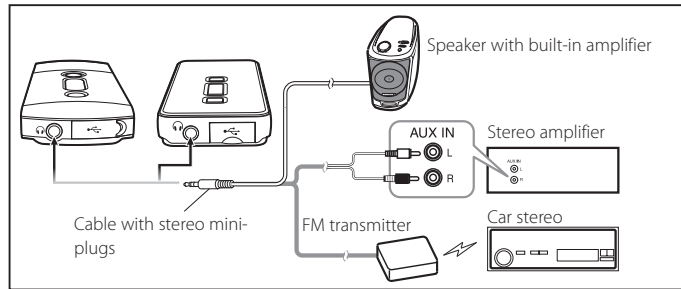

Connecting to the USB connector

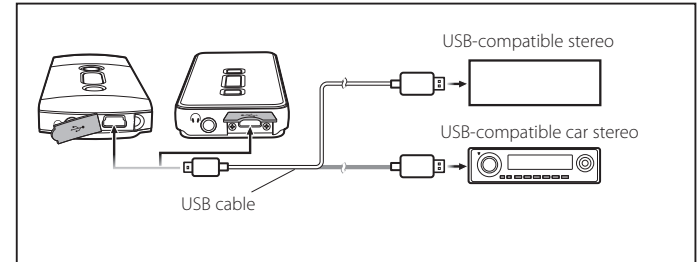

- Prepare an optimum audio cable (commercially available) according to the input terminal of the connected external component.
- Noise may be interfered depending the installation environment, including the vehicle model, devices in the surroundings and the antenna positioning.
- Do not use or leave the Player or connected component in an automobile compartment with high temperatures. Otherwise, equipment failure may result.



- For the operating procedure and the playable files, read the instruction manual for the connected stereo set.
- Do not use or leave the Player or connected component in an automobile compartment with high temperatures. Otherwise, equipment failure may result.

Digital Audio Player Link

When the Player is connected to a Kenwood audio component with the Digital Audio Player Link compatibility, playback of the Player can be controlled from the external audio component.

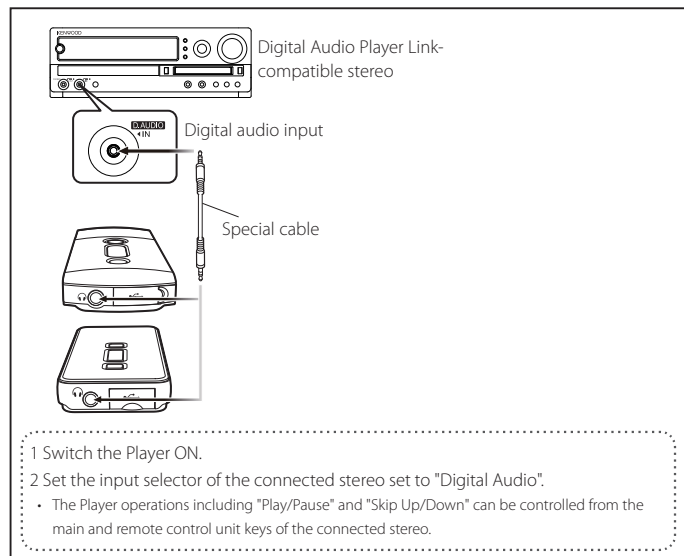

* Examples of Digital Audio Player Link-compatible stereo models
: AX-7, K-501USB, R-K1 (as of October 2007)



• For details and operating method of the Digital Audio Player Link, refer to the instruction manual for a Digital Audio Player Link-compatible audio component. This Player is not compatible with the "folder skip" function.

Glossary

DRM 10 (Digital Rights Management 10):

A copyright protection technology of Microsoft Corp., that was incorporated since Windows Media Player 10. It is compatible with fixed-rate distribution as well as traditional copy protection.

MP3:

An international data compression standard of MPEG, which is a working group in ISO (International Standardization Organization). It offers compression rates between about 1/10 and 1/12.

MSC (Mass Storage Class):

USB device type that is classified as a large-capacity storage device, the examples of which include a hard disk drive and CD drive.

When an MSC device is connected to a PC, the PC recognizes the device just like a removable disk, with which files can be exchanged easily using the standard drag & drop operation.

MTP (Media Transfer Protocol):

Data transfer protocol developed by Microsoft Corp. The data protected with DRM10 can be transferred using the MTP. Music files downloaded from a fixed-rate music distribution service can be transferred to the Player using this mode.

Tag data:

Information on each audio file, including the music title, artist name, album name and genre name.

WMA (Windows Media Audio):

An audio compressed encoding format developed by Microsoft Corporation. Also the extension used with audio files created using WMA.

Error messages

Message	Remedy
Not enough memory, Need 4MB free space	The memory capacity is low. An idle space of 4 MB is required to store the system information of the Player. Delete some files to increase the idle space.
File system error	An error occurred in the file system of the Player. Format the Player (page 16).
Unsupported file	An attempt is made to play a file that is not supported by the Player. For the file formats supported by the Player, see <Specifications> (page 30).
No playback license	A music track with DRM cannot be played because the license is expired or a music track with DRM has been transferred using an application other than Windows Media Player.
No contents	The Player does not store a playable music file such as the ones transferred from the PC.
Please wait	The music information in the memory is being updated. Wait until the updating completes.
Low battery	The remaining battery capacity is low. Recharge the battery.

Troubleshooting

The Player can often be recovered using the PC.

Try recovery from the PC in case of a trouble, for example, when the Player cannot be switched ON, it switches OFF spontaneously or the display is erroneous.

For details, refer to the support information in our website by visiting:

<http://www.kenwood.com/>

Symptom	Remedy
Power cannot be switched ON or pressing a button does not start an operation.	The HOLD function is ON. Cancel the HOLD function with the HOLD switch on the Player (page 8).
	The battery is nearly exhausted. Recharge it if it is rechargeable or replace it if it is an alkaline battery.
	The Player is being connected to the PC. The Player is inoperable when it is connected to the PC in the storage mode.
The KENWOOD logo appears but immediately disappears.	The HOLD function is ON. Cancel the HOLD function with the HOLD switch on the Player (page 8).
The remaining battery power drops soon after recharging.	The rechargeable battery is degraded. Replace it with a brand-new rechargeable battery. For the battery replacement, contact your nearest Kenwood service agent.
Audio is not heard.	Headphones are connected improperly. Connect headphones correctly to the Player.
Battery cannot be recharged.	USB cable is connected improperly. Check the connections on both the Player and PC sides.
	The ambient temperature is outside the operating temperature range. The battery should be recharged within the operating temperature range. (page 30)
	The player is connected to a USB hub. The player does not function if connected to a bus power type USB hub. Connect the player directly to the PC or to a self-powered USB hub.

PC does not recognize the Player.	USB cable is defective. Purchase and use another USB cable.
	The Player is connected to the PC improperly. Check the connection between the Player and PC.
	The player is connected to a USB hub. The player does not function if connected to a bus power type USB hub. Connect the player directly to the PC or to a self-powered USB hub.

Specifications

Built-in flash memory

M2GD55: 2 GB *1

M1GD50: 1 GB *1

Headphone output

: 3.5 mm stereo mini jack

: 3.5 + 3.5 mW/ 16 Ω

Interface

: USB 2.0 Full Speed

(USB 1.1 compatible)

Display

: 1 inch OLED *2

Main unit dimensions (W × H × D)

M2GD55:

38.0 mm × 92.5 mm × 11.5 mm

(1-1/2 × 3-5/8 × 7/16 inch)

M1GD50:

38.0 mm × 92.5 mm × 12.5 mm

(1-1/2 × 3-5/8 × 1/2 inch)

Weight (Net)

: Approx. 38 g (Approx. 0.08 lbs)

Operational Temperature Range

: 5 °C – +35 °C

(without condensation)

Battery type

: Built-in Li-ion rechargeable battery

Battery operation time *3

MP3 (128 kbps) : Approx. 21 hours

WMA (128 kbps) : Approx. 16 hours

Maximum number of files

: 1,000

Max. recording time/ tracks *4

M2GD55: Approx. 32 hours/

Approx. 480 tracks

M1GD50: Approx. 16 hours/

Approx. 240 tracks

Playback format

MP3

Sampling rate: 32/ 44.1/ 48 kHz

Bit rate: 16 - 320 kbps

Variable bit rate *5: 16 - 320 kbps

ID3 tag: ver. 2.2/ 2.3/ 2.4

WMA (DRM 10 compatible)

Sampling rate: 32/ 44.1/ 48 kHz

Bit rate: 32 - 320 kbps

Variable bit rate *5: 32 - 355 kbps

(Not supported by Professional, Lossless, or Voice.)

PC system configuration requirements *6

OS

: Microsoft® Windows® Vista/

XP/2000 (Not supported by 64 bit version OS.)

USB connector

: Compliant to USB 1.1/2.0 standard

• Kenwood follows a policy of continuous advancements in development. For this reason specifications may be changed without notice.

*1 The actual available space may be smaller than specified due to the presence of the system file area.

*2 The organic EL display is fabricated with high-precision technology. However, there may be some pixels that are permanently lit or extinguished. (This is not a failure.)

*3 Typical value when the provided headphones are used in the "Normal" sound mode. This value is not a guaranteed value. It may be shorter depending on the ambient temperatures and operating conditions.

*4 Assuming that each track is in the 128 kbps MP3/WMA format with playback time of about 4 min.

*5 Audio data with variable bit rate (VBR) may sometimes go beyond the bit rate range of the Player. In this case, the Player cannot play the audio data.

*6 All of the above specified PC environment does not guarantee full operation of the Player.

*7 Use a PC in which either OS mentioned above is preinstalled. Operation is not guaranteed on a PC running an upgraded OS or a PC assembled by yourself.

Notes on Disposal

Recycling the Built-in Battery

The Transmitter uses a lithium ion rechargeable battery cell as the built-in battery. The lithium ion rechargeable battery is a recyclable resource. When disposing of the Transmitter, take out the built-in battery and bring it to your local recycling business.

WARNING

- Do not heat excessively the built-in battery, open it, modify it or throw it in fire or water.
Excessive heat generation, explosion or fire ignition may cause a fire.
- Do not leave the built-in battery near fire or under direct sunlight.
A fire, explosion or excessive heat generation may result.
- Attach insulating tape on the connectors of the built-in battery.
A fire or explosion may result if the battery electrodes are short-circuited.
- Do not leave the built-in battery within the reach of children.
Injury or other accidents may result.
- If the built-in battery fluid leaks and enters your eyes, immediately rinse your eyes with fresh water and call a doctor.
If the fluid is left in your eyes, an eye injury may result.

Removing the Rechargeable Battery (Built-in Battery) Before Disposal: M2GD55

IMPORTANT:

Never attempt to open the Player besides when disposing of it.

For replacement of the built-in battery, contact your nearest Kenwood service agent.

- ① Open the USB cover.
- ② Remove the 2 screws from the panel using a precision Phillips screwdriver (+).
- ③ Remove the back panel (by releasing 7 latches).
- ④ Disconnect the built-in battery from the connector. Be careful not to apply an excessive force on the connector.
- ⑤ Take out the built-in battery. Be careful not to injure your nail or finger during removal.
- ⑥ Attach a piece of insulating tape on the connector at the end of the cable from the built-in battery, and put it in a plastic bag, etc.

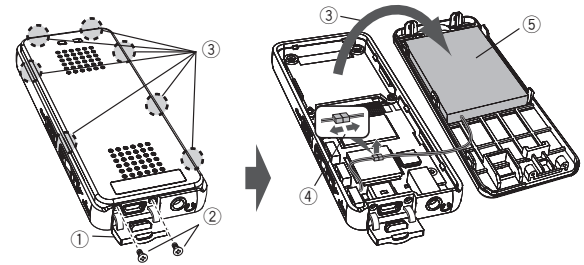

- Remove the built-in battery after having confirmed that it is completely discharged.
- Once the built-in battery is disconnected, do not attempt to reconnect it to the connector on the circuit board.
- Bring the removed built-in battery to a rechargeable battery recycling business as early as possible.

Removing the Rechargeable Battery (Built-in Battery) Before Disposal: M1GD50

IMPORTANT:

Never attempt to open the Player besides when disposing of it.

For replacement of the built-in battery, contact your nearest Kenwood service agent.

- ① Remove the rubber of back panel.
- ② Remove the 1 screw from the panel using a precision Phillips screwdriver (+).
- ③ Remove the front panel (by releasing 8 latches).
- ④ Remove the 4 screws from the circuit board using a precision Phillips screwdriver (+).
- ⑤ Take out the circuit board.
- ⑥ Disconnect the built-in battery from the connector. Be careful not to apply an excessive force on the connector.
- ⑦ Take out the built-in battery. Be careful not to injure your nail or finger during removal.
- ⑧ Attach a piece of insulating tape on the connector at the end of the cable from the built-in battery, and put it in a plastic bag, etc.

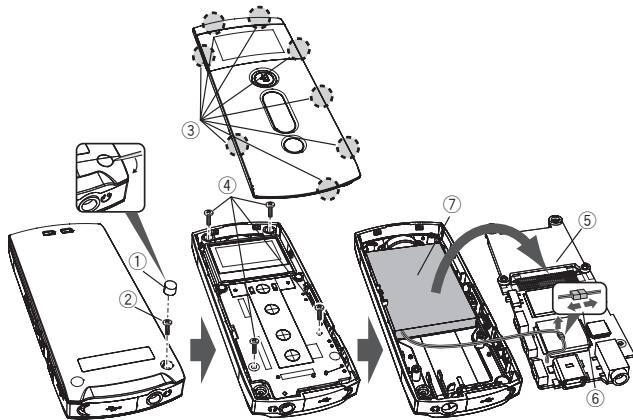

- Remove the built-in battery after having confirmed that it is completely discharged.
- Once the built-in battery is disconnected, do not attempt to reconnect it to the connector on the circuit board.
- Bring the removed built-in battery to a rechargeable battery recycling business as early as possible.



Declaration of Conformity with regard to the EMC Directive 2004/108/EC

Manufacturer:

Kenwood Corporation
2967-3 Ishikawa-machi, Hachioji-shi, Tokyo, 192-8525 Japan

EU Representative's:

Kenwood Electronics Europe BV
Amsterdamseweg 37, 1422 AC UITHOORN, The Netherlands

Information on Disposal of Old Electrical and Electronic Equipment (applicable for EU countries that have adopted separate waste collection systems)



Products with the symbol (crossed-out wheeled bin) cannot be disposed as household waste.

Old electrical and electronic equipment should be recycled at a facility capable of handling these items and their waste byproducts.

Contact your local authority for details in locating a recycle facility nearest to you. Proper recycling and waste disposal will help conserve resources whilst preventing detrimental effects on our health and the environment.

Trademark Information

- "Microsoft" and "Windows Media" are trademarks or registered trademarks of Microsoft Corporation in the USA and other countries.
- "Adobe Reader" is a trademark of Adobe Systems Incorporated.

Other system names and product names are also trademarks or registered trademarks of their respective developers. Note that the "™" and "®" markings are omitted in the text of this manual.

KENWOOD

Free Manuals Download Website

<http://myh66.com>

<http://usermanuals.us>

<http://www.somanuals.com>

<http://www.4manuals.cc>

<http://www.manual-lib.com>

<http://www.404manual.com>

<http://www.luxmanual.com>

<http://aubethermostatmanual.com>

Golf course search by state

<http://golfingnear.com>

Email search by domain

<http://emailbydomain.com>

Auto manuals search

<http://auto.somanuals.com>

TV manuals search

<http://tv.somanuals.com>