



KENWOOD
sovereign
INSTRUCTION MANUAL

Before applying power

 **Caution : Read this page carefully to ensure safe operation.**

Units are designed for operation as follows.

U.S.A. and Canada..... AC 120 V only

Europe and U.K. AC 230 V only

Other countries AC 110 - 240 V

For the United Kingdom

Factory fitted moulded mains plug

1. The mains plug contains a fuse. For replacement, use only a 13-Amp ASTA-approved (BS1362) fuse.
2. The fuse cover must be refitted when replacing the fuse in the moulded plug.
3. Do not cut off the mains plug from this equipment. If the plug fitted is not suitable for the power points in your home or the cable is too short to reach a power point, then obtain an appropriate safety approved extension lead or adapter, or consult your dealer.

If nonetheless the mains plug is cut off, remove the fuse and dispose of the plug immediately, to avoid a possible shock hazard by inadvertent connection to the mains supply.





IMPORTANT : The wires in the mains lead are coloured in accordance with the following code:

Blue : Neutral Brown : Live

Do not connect those leads to the earth terminal of a three-pin plug.

Safety precautions

WARNING : TO PREVENT FIRE OR ELECTRIC SHOCK, DO NOT EXPOSE THIS APPLIANCE TO RAIN OR MOISTURE.

		<p>CAUTION RISK OF ELECTRIC SHOCK DO NOT OPEN</p>	<p>CAUTION: TO REDUCE THE RISK OF ELECTRIC SHOCK, DO NOT REMOVE COVER (OR BACK). NO USER-SERVICEABLE PARTS INSIDE. REFER SERVICING TO QUALIFIED SERVICE PERSONNEL.</p>
	<p>THE LIGHTNING FLASH WITH ARROWHEAD SYMBOL, WITHIN AN EQUILATERAL TRIANGLE, IS INTENDED TO ALERT THE USER TO THE PRESENCE OF UNINSULATED "DANGEROUS VOLTAGE" WITHIN THE PRODUCT'S ENCLOSURE THAT MAY BE OF SUFFICIENT MAGNITUDE TO CONSTITUTE A RISK OF ELECTRIC SHOCK TO PERSONS.</p>		
	<p>THE EXCLAMATION POINT WITHIN AN EQUILATERAL TRIANGLE IS INTENDED TO ALERT THE USER TO THE PRESENCE OF IMPORTANT OPERATING AND MAINTENANCE (SERVICING) INSTRUCTIONS IN THE LITERATURE ACCOMPANYING THE APPLIANCE.</p>		

The marking of products using lasers (For countries other than U.S.A., U.S.- Military and Canada)

**CLASS 1
LASER PRODUCT**

The marking this product has been classified as Class 1. It means that there is no danger of hazardous radiation outside the product.

Location: Back panel

CAUTION
VISIBLE LASER RADIATION
WHEN OPEN. DO NOT
STARE INTO BEAM.

Inside this laser product, a laser diode classified as Class 2 laser radiation is contained as alerted by the internal caution label shown above. Do not stare into beam.

Location: DVD laser pick-up unit cover inside this product

Features

Compatible with DVD AUDIO, one of the latest digital audio formats

The DVD AUDIO reproduces 2-channel, 192 kHz, 24-bit sampled digital audio or 6-channel, 96 kHz, 24-bit sampled audio. This innovative technology has made possible audio reproduction in unprecedented high quality. Picture information and character information (DVD TEXT) are also provided.

Versatile DVD VIDEO Functions

The DVD VIDEO provides horizontal resolution of 430 lines, which exceeds that of DVD or S VHS video (400 lines) or laserdisc (430 lines).

Multi-audio function: With DVD discs marked with the  icon, the desired language can be played back by selecting it from up to 8 languages. (The number of available languages is variable depending on the discs.)

Multi-subtitle function: With DVD discs marked with the  icon, the subtitle language can be selected from up to 32 languages. (The number of subtitle languages is variable depending on the discs.)

Angle function: With DVD discs marked with the  icon, a single object can be viewed in up to 9 angles by switching. (The number of available angles is variable depending on the discs.)

Compatibility with Wide Range of Digital Surround Software

The unit incorporates Dolby Digital decoder, DTS decoder, MPEG multi-channel decoder and Packed PCM decoder so that the users can enjoy the sound of real cinemas. The unit can also be connected to the user's existing TV set

6-Channel Output Terminals

These output terminals can be connected to an amplifier with 6-channel input compatibility to enjoy high-bit, high-sampling rate multi-channel sound.

5-Disc Carousel Disc Changer

The disc tray can accommodate up to 5 discs and the disc can be changed while another disc is being played.

DVD player with CD-R and CD-RW disc compatibility

This DVD player can play back tracks recorded in CD-R (Compact Disc Recordable) and CD-RW (Compact Disc Rewritable) as well as those in music CD.

* Only finalized discs can be played back. However, certain discs may still be unplayable on this player.

MP3 playback capabilities

This player can also play back the MP3 files which are the latest formats for storage of music data. However, certain MP3 files may still be unplayable on this player.

Progressive scanning

The video display format can be switched between "Interlaced" and "Progressive" scanning.

Accessories

Joystick remote control unit (1)



Batteries (R6/AA) (2)



Audio cables (3)

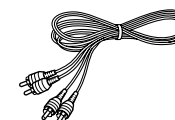

Video cable (1)

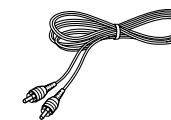

S Video cable (1)

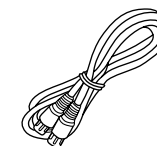

Coaxial cable (1)

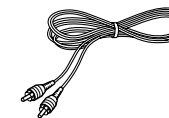



Unpacking

Unpack the unit carefully and make sure that all the accessories are present.

If any accessories are missing, or if the unit is damaged or fails to operate, notify your dealer immediately. If the unit was shipped to you directly, notify your shipper immediately. Kenwood recommends that you retain the original carton and packing materials in case you need to move or ship the unit in the future.

Keep this manual handy for future reference.

Contents **Caution : Read the pages marked carefully to ensure safe operation.**

 Before applying power	2	Display	16	Repeat playback	26
 Safety precautions	2	Switching the Display Brightness	16	A-B repeat playback	27
Features	3	Joystick Remote Control Unit	17	Pure Audio function	27
Accessories	3	When selecting a disc, displaying a still picture or letting playback pause temporarily	17	Switching the audio language	28
Systems and Types of Playable Discs	6	When repeating playback or switching the displayed information	18	Using Headphones	28
Unplayable Discs	6	When performing special playback or inputting a number	18	Chapter 4: OSD Operation	29
Icons Inscribed on DVD Discs	6	Chapter 3: Basic Operation	19	Basic OSD Operation	30
Region Codes of This Player (DVD VIDEO disc only)	6	Configuration of Discs	20	"MAIN" OSD Operation	31
Region codes of the DVD VIDEO discs that can be played with this player	7	Turning Power on	20	Selecting the disc to be played	31
Video Formats	7	STANDBY mode	21	Selecting a group, title, chapter, track, folder or file	31
Checking the Video Format	7	Inserting discs	21	Time display switching and time search	32
Chapter 1: Connection of Equipment ... 8		On Basic Operation	21	Memory playback	33
Before Start	9	Operation restriction according to the disc or player status	21	Repeat playback	33
Preparation of Remote Control Unit	9	Playing discs	21	A-B repeat playback	34
Installing the batteries	9	Playing discs by changing them	22	"SOUND" OSD Operation	35
Remote control range	9	Playing from the selected disc	22	Switching the audio language	35
MP3 Files That Can Be Played Back with This Equipment	9	Playing discs by selecting the group, title, chapter , track	22	Virtual Surround function	35
Connection with a TV or Stereo System	10	Skipping a track, chapter or file	22	Cinema Voice function	35
To Connect a TV	11	Stopping playback	22	Down Mix function	36
To Connect a Stereo System	11	Still picture display and playback pause	23	"VISUAL" OSD Operation	36
To Set Up of the Player	11	Frame-by-frame advance	23	Switching the subtitle language	36
Connection with an AV Amplifier	12	Forward search and reverse search	23	Adjusting the picture quality	36
To Connect an AV Amplifier	13	Slow playback and reverse slow playback	23	Switching the viewing angle	37
To Set Up of the Player	13	Menu playback of DVD	24	Chapter 5: Applied Operations	38
Chapter 2: Controls and indicators 14		Menu playback of P.B.C.-compatible VCD	24	Switching the Play Modes	39
Front Panel	15	Skipping indexes in DVD AUDIO	25	Program Playback	39
		Switching still pictures of DVD AUDIO	25	Registering and playing the program	39
		Switching the sequential play mode	25	Clearing the program	40
		Switching the time display	26	Stopping program playback	40
				Checking the program	40

Disc Random Playback	40
Stopping disc random playback	41
All Random Playback	41
Stopping all random playback	41
TEXT DISC Operation	41
Title search	41
Switching the character information	42
Displaying all character information	42
MP3 disc Operation	42
Switching the character information	42
Searching a desired folder/file by its title	43
Switching the "DVD VIDEO Mode"	43
Bonus Group	43

Chapter 6: Various Setups	44
Control Buttons Used in Setups	45
Basic Operations in Setup Screen	45
"MAIN" Setting	47
"Rating" Setting	47
"TV Aspect" Setting	49
"TV Mode" Setting	49
"TV Monitor Type" Setting	50
"DVD VIDEO Mode" Setting	51
"OSD Position" Setting	51
"On Screen Message" Setting	52
"IPB Display" Setting	53
"SOUND" Setting	54
"Digital Audio PCM Down Conversion" Setting (DVD VIDEO disc only)	54
"Digital Audio Dolby Digital" Setting	54
"Digital Audio DTS" Setting	55
"Digital Audio MPEG" Setting	56
"Speaker Setting"	56
"Audio During Search" Setting	60

"Dynamic Range Control" Setting	60
"Audio Filter" Setting	61
"VISUAL" Setting	62
"Player Menu Language" Setting	62
"Disc Menu Language" Setting	62
"Audio Language" Setting	63
"Subtitle Language" Setting	64
"Still Mode" Setting	64
"FL Mode" Setting	65
"NTSC → PAL" Setting	66
"SCART Output Select" Setting	66
"Black Level Setup" Setting	67
Disc Language Code Table	68

Chapter 7: Other Information	69
To Be Noted	70
Symptoms and Treatment	72
Glossary	74
Specifications	76



Systems and Types of Playable Discs

DVD AUDIO 	12 cm or 8 cm
DVD VIDEO 	12 cm or 8 cm
VCD 	12 cm or 8 cm
CD (CD-R, CD-RW) 	12 cm or 8 cm

Unplayable Discs

Never attempt to play a Photo CD on this unit.

Other discs which cannot be played on this unit:

- SACD, DVD-ROM, DVD-R/RAM, DVD-RW, CD-ROM, VSD, CDV*, CD-G*, CD-EG*, CD-EXTRA*, etc.
* Only the audio part can be reproduced.
- A DVD VIDEO disc with a region code which does not match this unit or without a region code. For details, see "**Region Codes of This Player**". 
- When the video format of a disc differs from that of the TV in use, the disc cannot be played normally. For details, see "**Video Formats**". 

Icons Inscribed on DVD Discs



Indicates the playable region code.



Indicates the number of languages in the audio. The figure in the icon shows the number (max. 8 languages).



Indicates the number of available subtitle languages. The figure in the icon shows the number (max. 32 subtitle languages).



Indicates the number of viewing angles which can be viewed with the angle function. The figure in the icon shows the number (max. 9 angles).

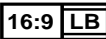

Indicates the number of available aspect ratios. LB stands for Letter Box and PS stands for Pan & Scan. (The example shown means that the 16:9 video can be converted into letterbox.)

Region Codes of This Player

(DVD VIDEO disc only)

A region code defined for each country or area is assigned for each DVD VIDEO player, so it cannot play a DVD VIDEO disc if its region code do not match that of this unit. Also, a disc which does not contain any region code may sometimes be unable to be played on the player.

When purchasing a DVD VIDEO disc, make sure that it has a region code which can be played on your player.

Region Code of Player: 

Usable Country or Area : Canada, United States, American Samoa, Bermuda, Johnston Island, Midway Islands, Puerto Rico, St. Pierre and Miquelon, United States Virgin, Wake Island

Region Code of Player : 

Usable Country or Area : Albania, Andorra, Austria, Bahrain, Belgium, Bosnia and Herzegovina, Bulgaria, Croatia, Cyprus, Czech, Denmark, Egypt, Finland, France, Germany, Greece, Hungary, Iceland, Iran, Iraq, Ireland, Israel, Italy, Japan, Jordan, Kuwait, Lebanon, Lesotho, Liechtenstein, Luxembourg, Macedonia, Malta, Monaco, Netherlands, Norway, Oman, Poland, Portugal, Qatar, Romania, San Marino, Saudi Arabia, Slovakia, Slovenia, South Africa, Spain, Swaziland, Sweden, Switzerland, Syrian Arab Republic, Turkey, United Arab Emirates, United Kingdom, Vatican City State, Yemen, Yugoslavia, Channel Islands, Faeroe Islands, Gibraltar, Greenland, Isle of Man, Svalbard and Jan Mayen Islands

Region Code of Player : 

Usable Country or Area : Brunei Darussalam, Cambodia, Indonesia, Korea, Laos, Malaysia, Myanmar, Philippines, Singapore, Thailand, Viet Nam, East Timor, Hong Kong, Macau, Taiwan

Region Code of Player : 

Usable Country or Area : Antigua and Barbuda, Argentina, Australia, Bahamas, Barbados, Belize, Bolivia, Brazil, Chile, Colombia, Costa Rica, Cuba, Dominica, Dominican Republic, Ecuador, El Salvador, Fiji, Grenada, Guatemala, Guyana, Haiti, Honduras, Jamaica, Kiribati, Marshall Islands, Mexico, Micronesia, Nauru, New Zealand, Nicaragua, Palau, Panama, Papua New Guinea, Paraguay, Peru, Saint Christopher and Nevis, Saint Lucia,

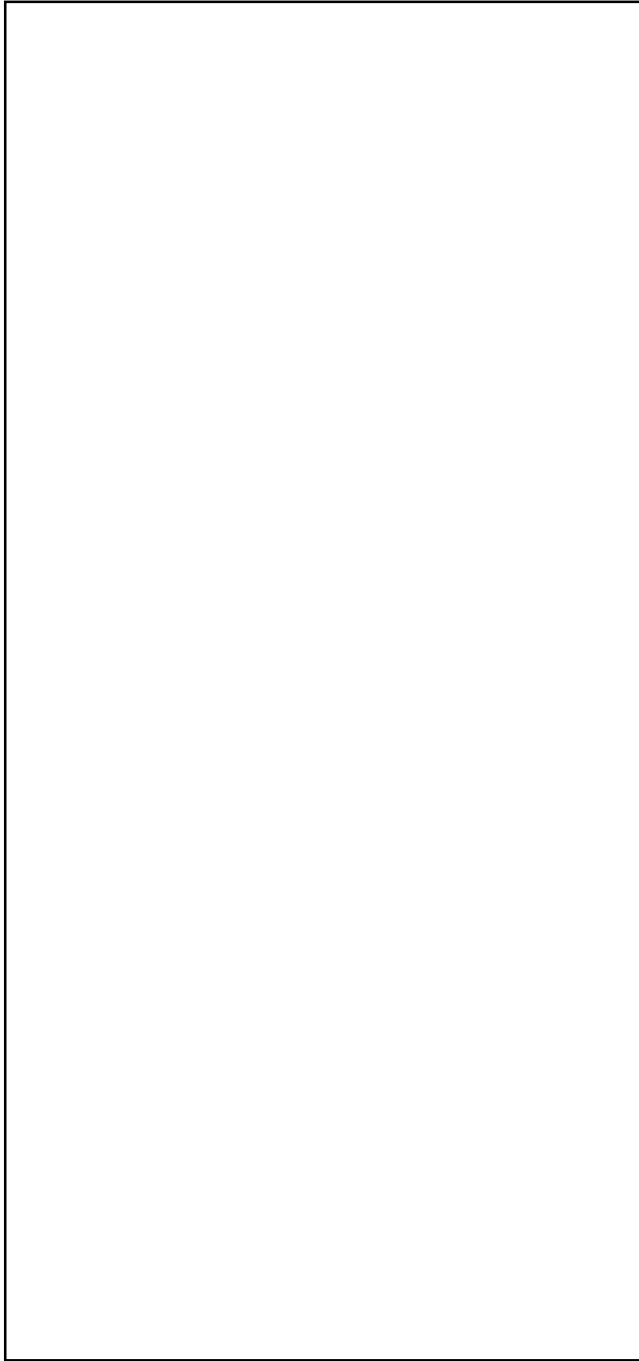

Region codes of the DVD VIDEO discs that can be played with this player

This player can play back a DVD VIDEO disc which carries the corresponding code to the region code of the player shown in the table above, a marking containing the region code of the player or the "ALL" marking shown below. Even when a DVD VIDEO disc does not carry any indication of the region code, it may sometimes be unable to be played on this player due to certain restrictions.



Video Formats

Chapter 1: Connection of Equipment

This manual describes the standard, most typical connections of the player. When an associated system component is connected, also refer to their instruction manuals.

For details on the connection of the following components, see the indicated reference pages.

Before Start →  9

Preparation of Remote Control Unit →  9

MP3 Files That Can Be Played Back with This Equipment →  9

Connection with a TV or Stereo System →  10

Connection with an AV Amplifier →  12

Before Start

Do not insert the power cord plug of the player and the connected components until all of the components have been connected.

Be sure to insert all connection cables securely. If a cable is plugged incompletely, lack of video, lack of audio or noise may result.

Before connecting or disconnecting a connection cord, be sure to unplug the power plug from the wall power outlet. If a connection cable is connected or disconnected while the power plug is left connected, malfunction or equipment damage may result.

When a DVD AUDIO disc is played, the player can output audio signals at very high frequencies. As this may sometimes lead to speaker damage due to a high-volume sound, do not set "Audio Filter" to "Filter 110 kHz" when the speakers in use are not suitable for high-frequency reproduction. — 61

Also, be sure to check the actual sound level when increasing or decreasing the volume control setting.

Remote control range:

If the joystick remote is used outside this area, correct operations will not be possible.

- When the controllable distance of the joystick remote reduces, replace both batteries with new ones.
- Do not install the player in a place where the remote control sensor is subjected to direct sunlight or the light of a fluorescent lamp base on high-frequency lighting (inverter system, etc.). Otherwise, the control range of the joystick remote will be reduced.

Preparation of Remote Control Unit

Installing the batteries:

Open the cover and insert the batteries (R6/AA) by observing the polarity marking.

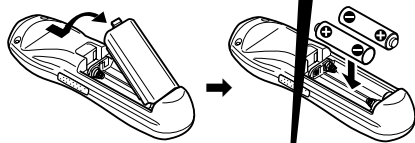

Connection with a TV or Stereo System

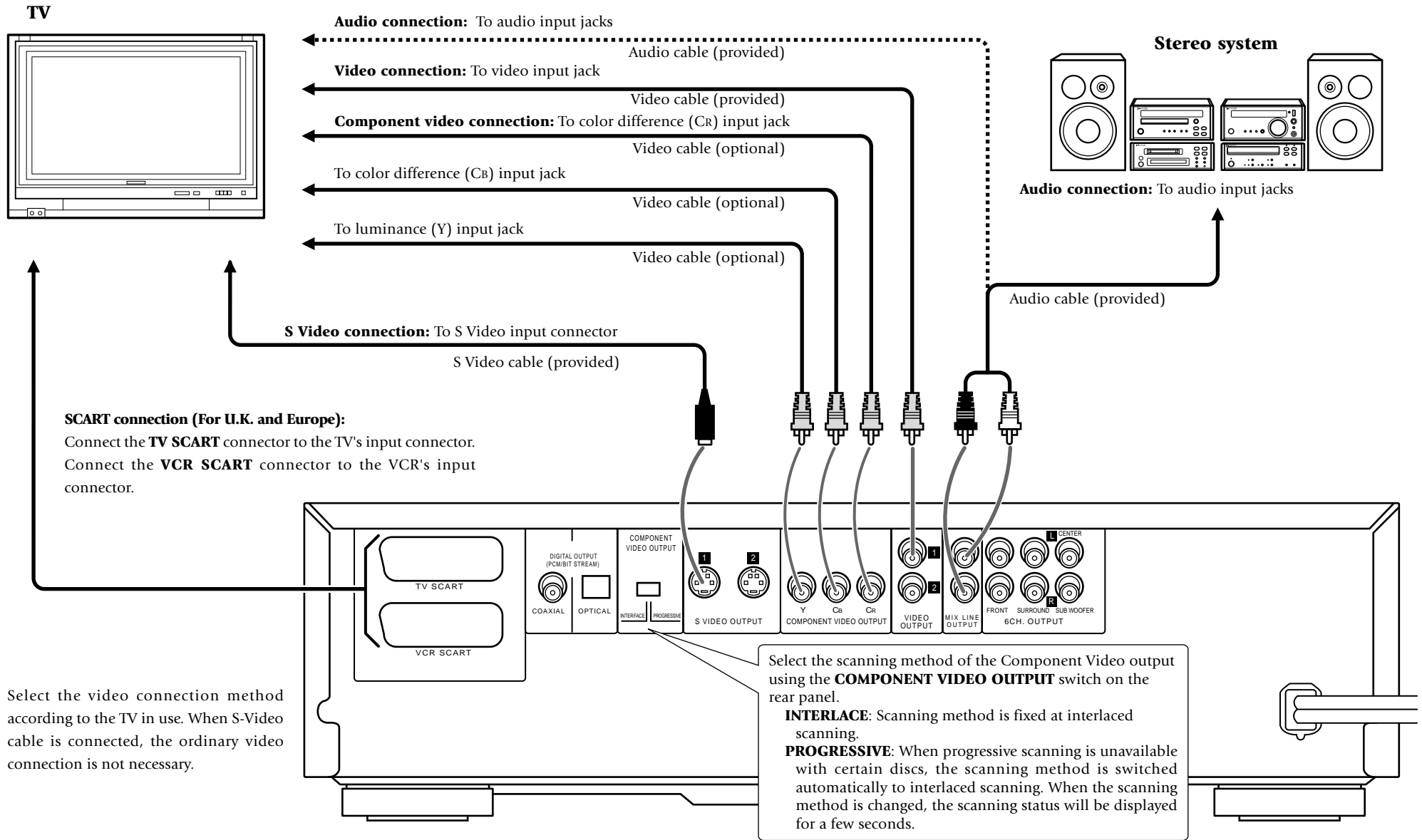

Connection with a TV or Stereo System

Do not insert the power cord plugs of the player and the connected components until all of the components have been connected.

For details on the connection terminals and functions of the TV, refer to its instruction manual.

The video output from the player should be connected directly to the TV. If the video output is connected through a VCR, the picture displayed on the TV may be disturbed due to the copy protect function.

To Connect a TV

Video connection: Connect the **VIDEO OUTPUT** jack of the player to the video input of the TV using the provided video cable.

S Video connection: If the TV has an S Video input connector, connect the **S VIDEO OUTPUT** connector of the player to it using the provided S Video cable.

- As S Video separates video signal into the luminance signal (Y) and color signal (C), it can provide sharper pictures than ordinary video connection.

Component video connection: If the TV has component video input jacks, connect the **Y, Cb** and **Cr COMPONENT VIDEO OUTPUT** jacks of the player to the corresponding jacks on the TV using video cables.

- As component video separate video signal into the luminance signal (Y) and color difference signals (Cb, Cr), it can provide sharper image than the S Video connection.
- Depending on the TV or video monitor in use, the terminal names may be different from those used with the player (Y/Pb/Pr or Y/B-Y/R-Y, etc.)
- When the TV in use is a HDTV or "Hi-Vision" TV, connect the component video signals from the player only to the DVD-compatible input jacks.

SCART connection (For Europe and U.K.): If the TV or VCR has SCART connectors, connect the **TV SCART** or **VCR SCART** connector of this unit to the TV or VCR using SCART cables.

- The audio and video signals can be output using a single cable. The signal output from the **TV SCART** connector can be switched between composite video, S Video and RGB. (The **VCR SCART** connector always outputs composite video signals so its output signals cannot be selected.)
- When the TV is connected through a VCR using SCART connection, the picture displayed on the TV may be disturbed due to the copy protect function.
- When using only the TV and VCR which are both connected with the player using the SCART connection, the signal from the VCR cannot be sent to the TV if the player is switched off. (In this case, set the player to the power standby mode.)

Audio connection: Connect the **MIX LINE OUTPUT** jacks of the player to the audio input jacks of the TV using the provided audio cables.

COMPONENT VIDEO OUTPUT switch: Use this switch to switch the video display format (between Interlaced and Progressive scanning). Be sure to unplug the power cord from the power outlet before changing the position of this switch.

- When using the Component Video Output, do not set the "**SCART OUTPUT SELECT**" setting in the "**SET UP MENU**" to "**RGB**". (For Europe and U.K.)

To Connect a Stereo System

Audio connection: Connect the **MIX LINE OUTPUT** jack of the player to the audio input jacks of the connected audio component such as a stereo system using the provided audio cables.

- When playing a disc containing MPEG multi-channel audio recording, connect the stereo input to the **6CH. OUTPUT L/R** jacks and activate the **DOWN MIX** function. → [36](#)

To Set Up of the Player

Setup of Menu screen: The language to be used in the menus of the player can be selected.

- The default language set at the factory is English.

"**Player Menu Language**" Setting → [62](#)

Setups Related to TV: The following setups can be made according to the TV connected to the player.

"**TV Aspect**" Setting → [49](#)

"**TV Mode**" Setting → [49](#)

"**TV Monitor Type**" Setting → [50](#)

Setup of SCART output signals: The signals output from the **TV SCART** connector of the player can be selected.

"**SCART Output Select**" Setting → [66](#)

CAUTION

Be sure to adhere to the following, or proper ventilation will be blocked causing damage or fire hazard.

- Do not place any objects impairing heat radiation onto the top of the unit.
- Leave some space around the unit (from the largest outside dimension including projection) equal to or greater than, shown below.

Top panel : 10 cm Back panel : 10 cm

Connection with an AV Amplifier

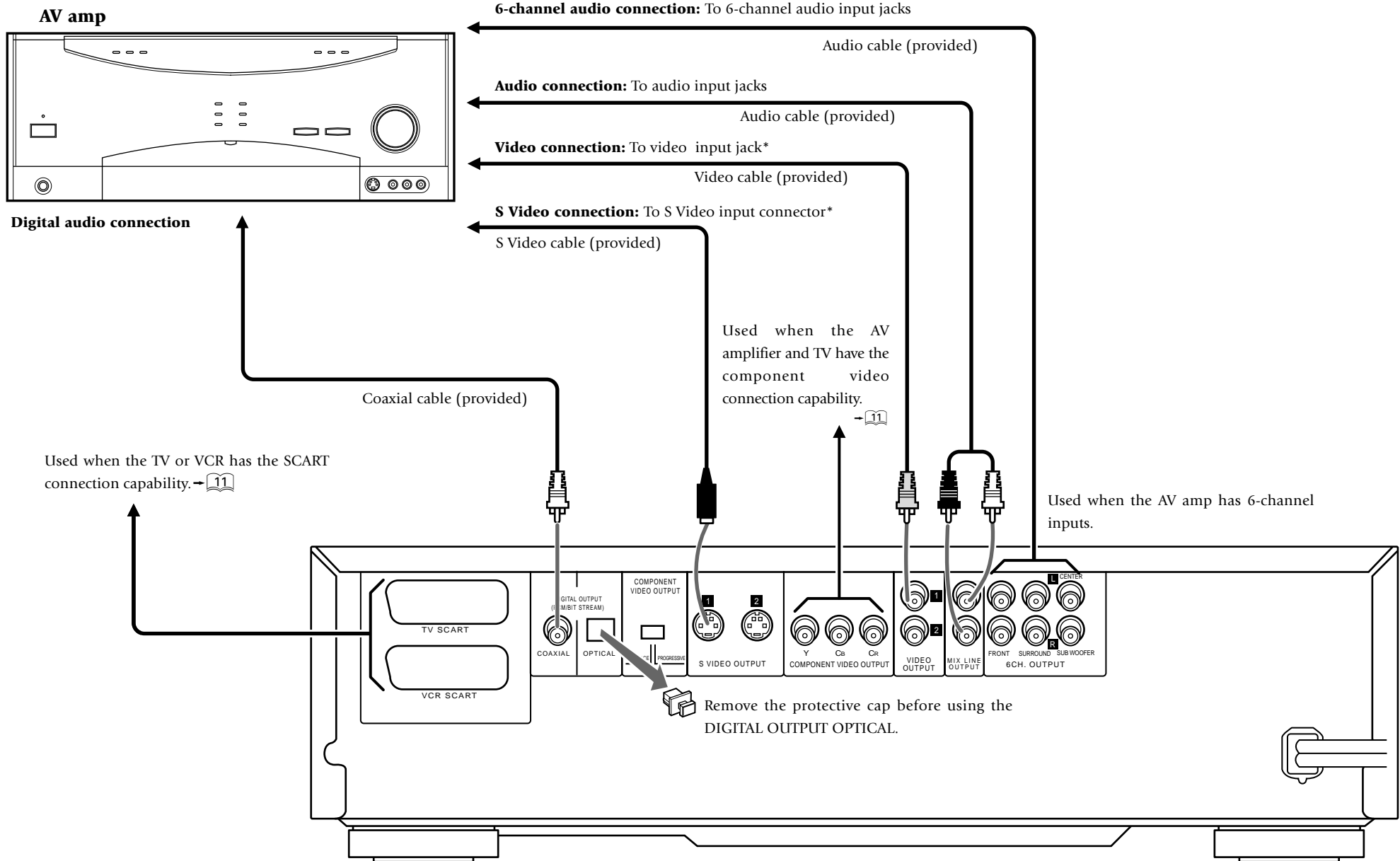

* Select the video connection method according to the TV in use. When S-Video cable is connected, the ordinary video connection is not necessary.

Connection with an AV Amplifier

Do not insert the power cord plugs of the player and the connected components until all of the components have been connected.

For details on the connection terminals and functions of the AV amplifier, refer to its instruction manual.

The video output from the player should be connected directly to the AV amplifier. If the video output is connected through a VCR, the picture displayed on the TV may be disturbed due to the copy protect function.

To Connect an AV amplifier

6-Channel audio connection: When the connected AV amplifier has 6-channel audio input jacks, connect the **6CH. OUTPUT** jacks of the player to them.

- When an amplifier which is not compatible with 6-channel inputs is connected, use the signals from the **MIX LINE OUTPUT** jacks of the player. The multi-channel surround audio will be down-mixed and output. 

Audio connection: Connect the **MIX LINE OUTPUT** jacks of the player to the audio input jacks of the AV amplifier using the provided audio cables.

Digital audio connection: Connect the **COAXIAL DIGITAL OUTPUT** connector of the player to the digital audio input connector of the AV amplifier.

- It is also possible to perform digital connection using a commercially available optical fiber cable and the **OPTICAL DIGITAL OUTPUT** jack.

Video connection: Connect the **VIDEO OUTPUT** jack of the player to the video input jack of the AV amplifier using the provided video cable.

S Video connection: When the connected TV has an S Video connector, connect the **S VIDEO OUTPUT** connector of the player to it using the provided S Video cable.

- As S Video separates video signal into the luminance signal (Y) and color signal (C), it can provide sharper pictures than ordinary video connection.

To Set Up of the Player

Setup of Menu screen: The language to be used in the menus of the player can be selected.

- The default language set at the factory is English.

"Player Menu Language" Setting 

Setup for digital audio connection: If the connected AV amplifier does not contain any of Dolby Digital, DTS and MPEG decoder, be sure to set the **"Digital Audio"** settings after connecting the player to it.

For the nonexistent decoders, set the **"Digital Audio"** setting to **"PCM"**. If the player is played without changing the initial **"Bitstream"** setting, extremely loud noise will be produced and may damage the speakers.

"Digital Audio PCM Down Conversion" Setting

 54

"Digital Audio Dolby Digital" Setting

 54

"Digital Audio DTS" Setting

 55

"Digital Audio MPEG" Setting

 56

Setup for 6-channel audio connection: When the audio is connected using the **6CH. OUTPUT** jacks of the player, set the player as follows.

"Speaker Setting" 

 56

Audio output from DVD AUDIO

When the **"D.MIX"** (down-mix) indicator is not lit, the **MIX LINE OUTPUT**, **DIGITAL OUTPUT** and **PHONES** output jacks output the front (L/R) channel signals instead of the down-mixed 2-channel signals. The **6CH. OUTPUT** jacks output the same number of channels as the original number of channels recorded in the DVD AUDIO disc, regardless of the speaker setting. When the **"P.PCM"** indicator is lit, the **6CH. OUTPUT** jacks output the same number of channels as the original number of channels regardless of whether the **"D.MIX"** indicator is lit or not.

DTS disclaimer clause

DTS Digital Surround™ is a discrete 5.1 channel digital audio format available on CD, LD, and DVD software which consequently cannot be decoded and played back inside most CD, LD, or DVD players. For this reason, when DTS-encoded software is played back through the analog outputs of the CD, LD, or DVD player, excessive noise will be exhibited. To avoid possible damage to the audio system, proper precautions should be taken by the consumer if the analog outputs are connected directly to an amplification system. To enjoy DTS Digital Surround™ playback, an external 5.1 channel DTS Digital Surround™ decoder system must be connected to the digital output (S/P DIF, AES/EBU, or TosLink) of the CD, LD or DVD player.

This unit is equipped with DTS Digital Surround™ decoder.

Chapter 2: Controls and indicators

This chapter gives description on the front panel buttons, display panel of the player main unit and the provided joystick remote control unit.

This chapter is composed of the following sections.

Front Panel →  15

Display →  16

Joystick Remote Control Unit →  17

Front Panel

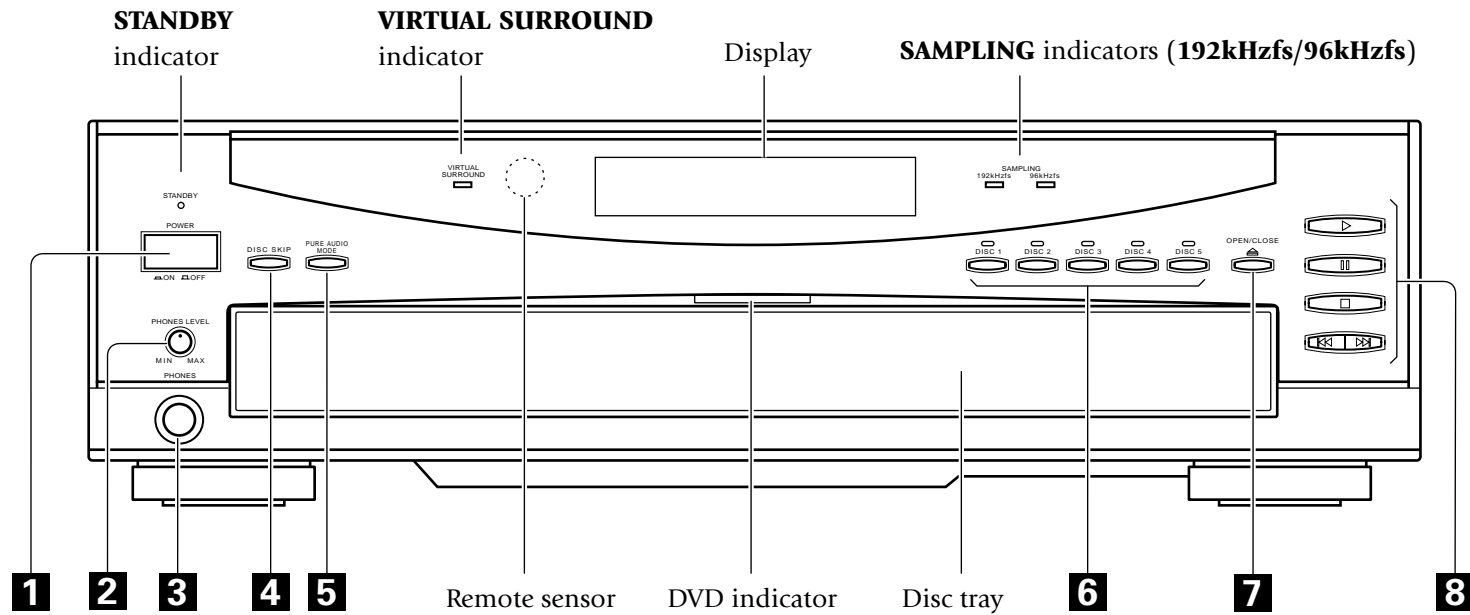

- | | | | |
|--|------|--|------|
| 1 POWER button | - 20 | 6 DISC 1 ~ 5 buttons/indicators | - 22 |
| 2 PHONES LEVEL knob | - 28 | 7 OPEN/CLOSE ▲ button | - 21 |
| 3 PHONES jack | - 28 | 8 ► (play) button | - 21 |
| 4 DISC SKIP button | - 22 | ⏸ (pause, still) button | - 23 |
| 5 PURE AUDIO MODE button/ indicator | - 27 | ■ (stop) button | - 22 |
| | | ⏮ / ⏭ (skip down & skip up) buttons | - 22 |

Display

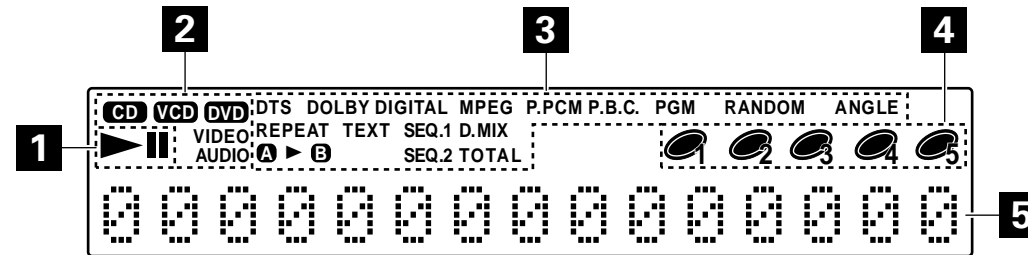

1 Operation indicators

2 "CD", "VCD", "DVD VIDEO", "DVD AUDIO" indicators

3 CD(CD-R/RW), VCD and DVD related indicators

Special playback related indicators

→ [25](#) → [27](#) → [34](#) → [40](#) → [41](#)

4 Disc number indicators

5 Character information display

→ [21](#) → [39](#) → [41](#) → [42](#)

Switching the Display Brightness

Press the **DISPLAY** button on the joystick remote to switch the display brightness in the following sequence.

"BRIGHTNESS" : The display is permanently in high brightness.

"DIMMER" : The display is permanently displayed in low brightness.

"AUTO OFF" : The display is automatically turned off with DVD or VCD. (The display is shown when DVD AUDIO without video is played.) At this time, the **"Disc 1 to 5"** indicators light in low brightness and other indicators are off.

"FL OFF" : The display is turned off. At this time, the **"Disc 1 to 5"** indicators light in low brightness and other indicators are off.

● When the power is off or standby, the setting performed in **"FL Mode"** is given priority. (**"FL OFF"** cannot be selected with the **"FL Mode"** setting) → [65](#)

Joystick Remote Control Unit

When operating the joystick remote, first set the mode switch to the Blue, Purple or Orange position according to the purpose.

The buttons shown in the following figure always function in the same way regardless of the position of the mode switch. (The buttons with the same names as those on the player main unit have the same functions as the main unit buttons.)

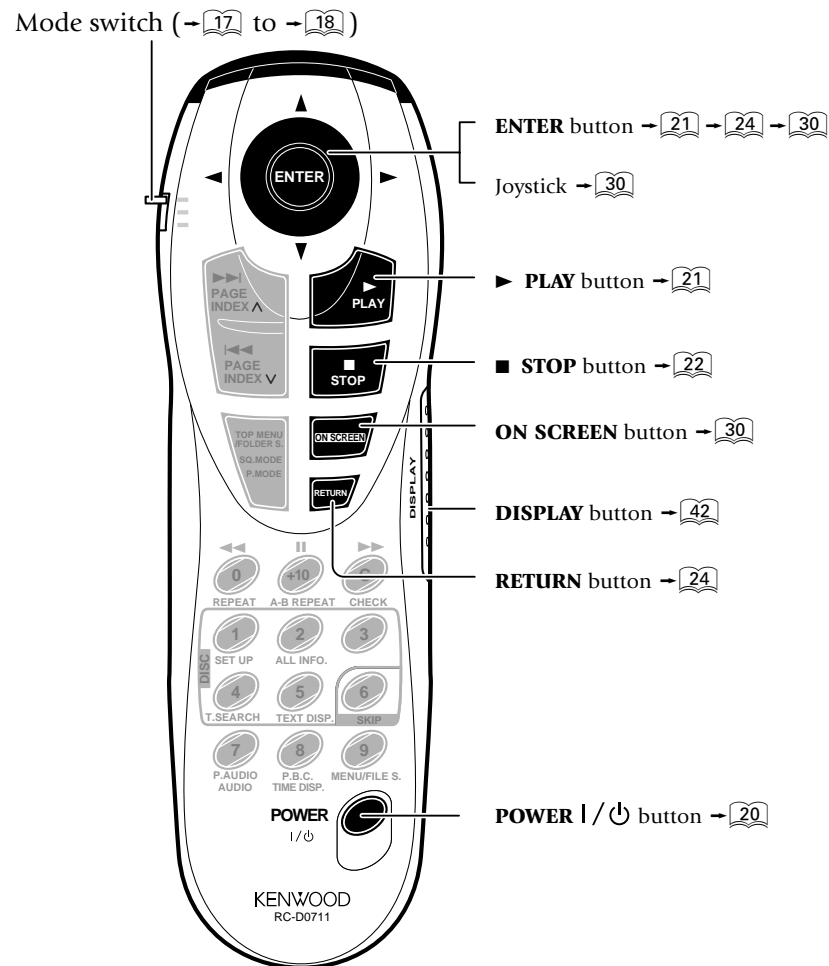

When selecting a disc, displaying a still picture or letting playback pause temporarily

Set the mode switch to the Blue position. The functions of some buttons change as shown below.

Set to the Blue position

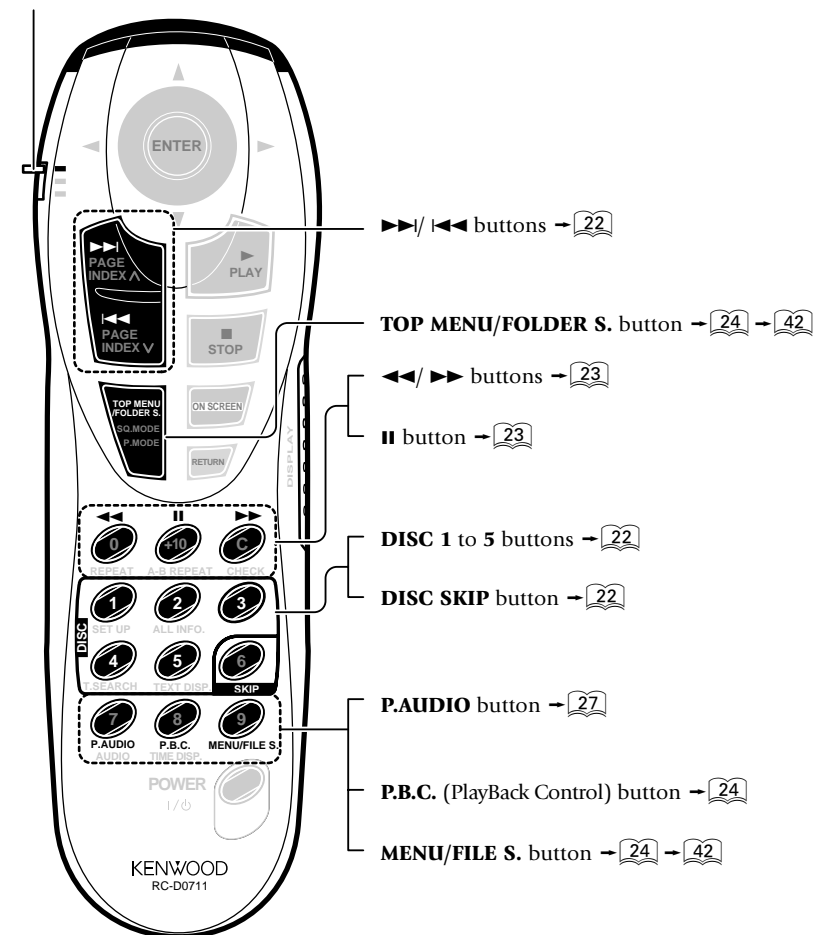

When repeating playback or switching the displayed information

Set the mode switch to the Purple position. The functions of some buttons change as shown below.

When performing special playback or inputting a number

Set the mode switch to the Orange position. The functions of some buttons change as shown below.

Set to the Purple position

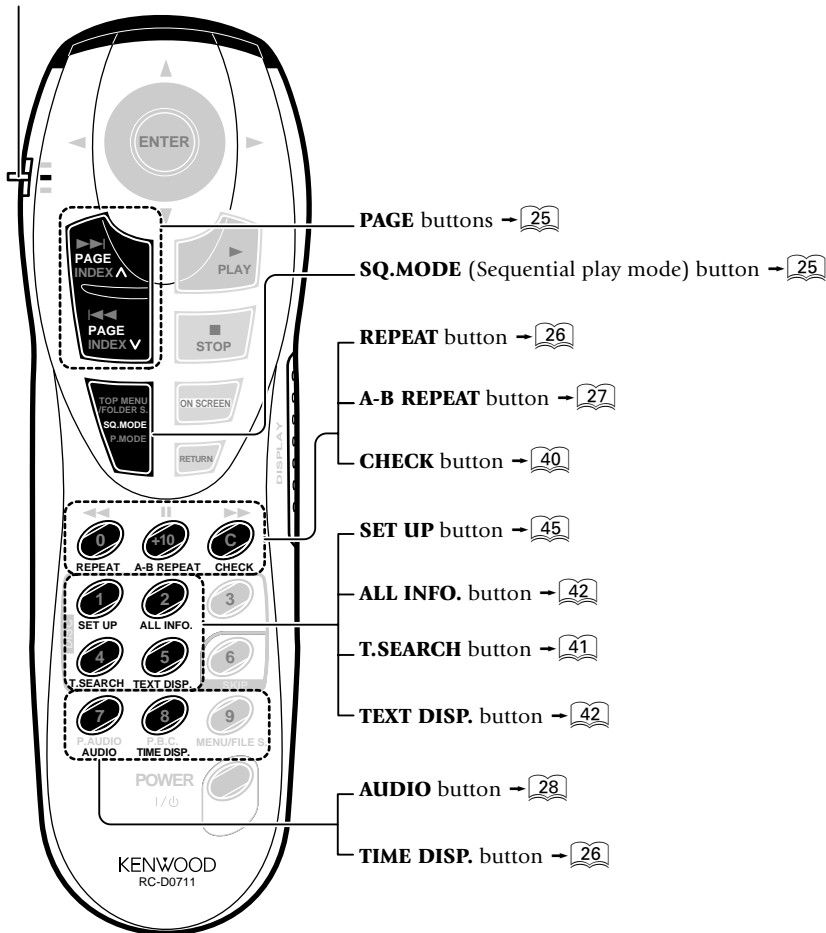

Set to the Orange position

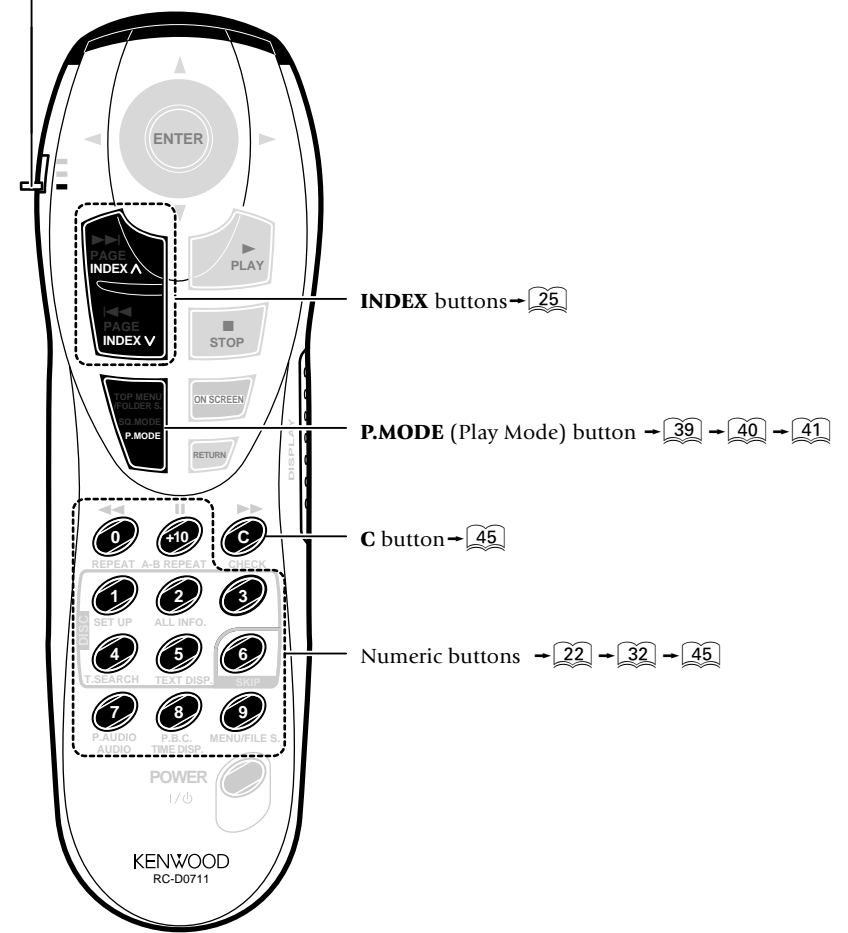

Chapter 3: Basic Operation

This chapter gives description on the basic operations of the control buttons on the player main unit and joystick remote.

This chapter is composed of the following sections.

Configuration of Discs →  20

Turning power on →  20

Inserting discs →  21

On Basic Operation →  21

Using Headphones →  28

Configuration of Discs

DVD AUDIO disc configuration

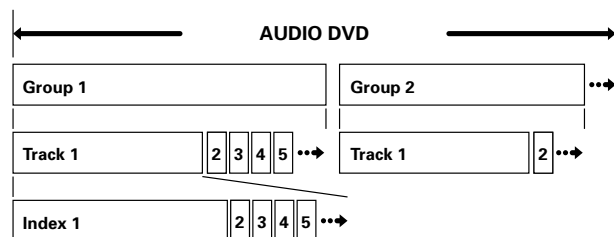

The group is the largest unit composing the music in an DVD AUDIO disc. Each group is composed of multiple tracks, and each track is composed of multiple indices.

DVD VIDEO disc configuration

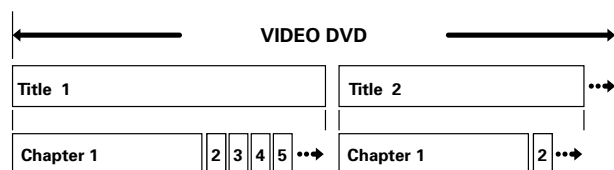

The title is the largest unit composing the music and/or pictures in an DVD VIDEO disc. Each title is composed of multiple chapters.

CD and VCD disc configuration

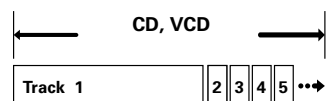

MP3 disc configuration

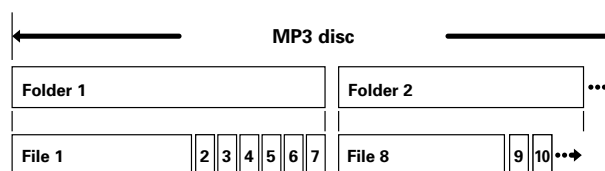

The folder is the storage unit at the highest level in the disc. Sometimes a single folder contains more than one file, or sometimes files are recorded directly in the disc in place of being included in a folder. Some discs also have a hierarchical structure in which a folder includes sub-folders. Note that the file numbers are not assigned on a per-folder basis but they are assigned consecutively for all the files in the whole disc.

Turning power on

1. Turn the connected components on and set the input selector of the connected amplification component to "DVD"

2. Press  on the player. The "STANDBY" indicator lights, indicating that the power of the player is in the standby mode.

When the power of the player is in the standby mode,

press  on the joystick remote.

- When the player is turned on, it reads the discs in the tray and lights the disc number indicators on the display to inform the user of presence and absence of discs. If there is any disc in the tray at this moment, the disc will be played back automatically.

"NO PLAY" is displayed when the loaded disc is not playable on this player.

[To put the player power in the standby mode]

- When the power is on, press the **POWER**  button on the joystick remote. The "STANDBY" indicator lights up to indicate that the player is in the standby mode of power.

[To turn the player off]

- When the power is on or standby, press the **POWER** button on the player main unit to turn it off.

STANDBY mode:

While the **STANDBY** indicator is lit, a small amount of power is supplied to the system to back up the memory. This is called standby mode. Under the condition, the system can be turned ON by the remote control unit.

[When you are going to leave the listening room]

When the power is on or standby, it can be turned off by pressing the **POWER** button on the player main unit. (The "**STANDBY**" indicator does not lit in this status.)

Inserting discs

The disc tray accommodates up to five discs. The discs can be changed during playback without stopping the currently played disc.



Be sure to operate a button when opening/closing the tray or rotating the tray. Never attempt to move the tray with your hand.

1. Press  on the player main unit to open the tray.

(Pressing the button again closes the tray.)

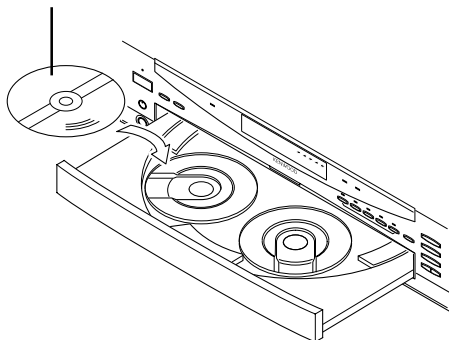
The label surface must face upward. (With a double-sided disc, load it so that the label information for the side you want to play faces upward.)



- Place the disc to be played along the groove on the tray. (To prevent malfunction, do not place a disc obliquely or on another disc.)
 - When handling a disc, take care not to touch the disc surface.
 - Commercially available CD single (8 cm) disc adapters cannot be used with this player.
2. To insert or remove another disc by changing the tray position, press  on the player main unit.
 - If you are operating the joystick remote, set the mode switch to the Blue position then press the **DISC SKIP** button.
 3. Press  on the player main unit to close the tray.

On Basic Operation**Operation restriction according to the disc or player status**

Operations of some DVDs and VCDs are restricted by the intention of the software producers. Operations may also be restricted due to the status of the player.

As this player plays discs in accordance with the intentions of software producers, some functions may not work as intended by the user. Be sure to read the manual provided with the disc to be played. When an inhibition icon is displayed on the connected TV screen during operation, it indicates that the player is in the operation restricted status.

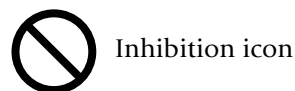

Inhibition icon

Playing discs

Press  in stop mode to start playback.

- When you are operating the joystick remote, press the ► **PLAY** or **ENTER** button.
- Playback starts with the disc indicator of which is lit.
- The TV screen shows "**Play**" and the ► indicator in the display lights up.
- The "**CD**", "**VCD**", "**DVD AUDIO**" or "**DVD VIDEO**" indicator in the display lights up according to the type of the disc.
- Certain CD-R and CD-RW discs may not be playable on this player. ("**NO PLAY**" is displayed in this case.)
- The CD indicator lights when a CD-DA, MP3 disc is loaded.
- When the loaded disc contains text data such as the disc title, the text will be scrolled on the display on this player.
- With certain DVD and VCD discs, a menu is displayed in the beginning.

Playing discs by changing them

Press  to skip a disc.

- When you are operating the joystick remote, set the mode switch to the Blue position and press the **DISC SKIP** button.
- When the **DISC SKIP** button is pressed while the tray is open in stop mode, the tray simply rotates.
- The disc number indicator above one of the **DISC 1** to **5** buttons on the player main unit lights up and playback starts.
- The **DISC SKIP** button is invalid when the tray is closed in the all random and program modes.

Playing from the selected disc

Press one of  to  to select a disc.

- When you are operating the joystick remote, set the mode switch to the Blue position and press one of the **DISC 1** to **5** buttons.
- The disc number indicator above one of the **DISC 1** to **5** buttons on the player main unit lights up and playback starts.
- The **DISC 1** to **5** buttons are invalid in the all random and program play modes.

Playing discs by selecting the group, title, chapter, track

Set the mode switch of the joystick remote to the

Orange position and input the number of the group,

title, chapter or track using  to  and .

- With a DVD disc when a number is input during playback, playback of the chapter or track having the same number as the input number in the same group, or title starts. When a number is input in stop mode, playback the first chapter, or track having the same number as the input number starts.
- With a CD or VCD (when P.B.C. is off), playback starts with the beginning of the track having the same number as the input number.
- With a MP3 disc, playback starts with the beginning of the file having the same number as the input number.

Skipping a track, chapter, or file

Press  or 

Still picture display and playback pause

Press  during playback.

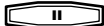

- If you are operating the joystick remote, set the mode switch to the Blue position and press the **||** button.
- The TV screen shows "**Pause**" or "**Still**" and the **||** indicator in the display lights up.
- To restart normal playback, press the **▶** button on the player main unit or the **▶ PLAY** button on the joystick remote.
- When the "**IPB Display**" is set to On, the TV screen shows "**Still (I)**", "**Still (P)**" or "**Still (B)**" with every still picture of DVD VIDEO.
- This operation is not available with a MP3 disc.

Frame-by-frame advance

While a still picture of DVD VIDEO or VCD is displayed, press .

- If you are operating the joystick remote, set the mode switch to the Blue position and press the **||** button.
- The picture returns to still picture when the **||** button is released.
- The picture frame is advanced for the same number of times as the button is pressed. Hold the button when you want to advance picture frames sequentially.
- To restart normal playback, press the **▶** button on the player main unit or the **▶ PLAY** button on the joystick remote.
- When the "**IPB Display**" is set to On, the TV screen shows "**Still (I)**", "**Still (P)**" or "**Still (B)**" every time the picture frame of DVD is advanced.

Forward search and reverse search

During playback, set the mode switch of the joystick remote to the Blue position and press  or .

- When OSD is displayed, pressing the **ON SCREEN** button turns it off and shows the speed in place.
- The first press of the **◀◀** or **▶▶** button starts forward search or reverse search at the lowest speed step. Each further press increase the speed up to the fifth speed step.



The TV screen shows the speed as shown above. The indicator varies according to the speed of the forward search or reverse search.

- The display of the player shows the time display or "**SEARCH →**" according to the status of the disc and player.
 "**SEARCH →**" is displayed :
 When the time information is not displayed during DVD playback.
 When P.B.C. is on during VCD playback.
- To restart normal playback, press the **▶** button on the player main unit or the **▶ PLAY** button on the joystick remote.
- Video may be disturbed during forward search or reverse search.
- When performing forward search with a VCD, DVD VIDEO or DVD AUDIO containing video and moving pictures (AVTT: Audio Video Title), the audio output can be switched on or off only while the search is at the lowest speed step. The audio is muted in the second and later speed steps.
- This operation is not available with a MP3 disc.

Slow playback and reverse slow playback

While a still picture is displayed, set the mode switch of the joystick remote to the Blue position and press



- When OSD is displayed, pressing the **ON SCREEN** button turns it off and shows the speed in place.
- The first press of the **◀◀** or **▶▶** button starts slow playback or reverse slow playback at the lowest speed step. Each further press increase the speed up to the fifth speed step.



The TV screen shows the speed as shown above. The indicator varies according to the speed of the slow playback or reverse slow playback.

- The display of the player shows the time display or "**SEARCH →**" according to the status of the disc and player.
 "**SEARCH →**" is displayed :
 When the time information is not displayed during DVD playback.
 When P.B.C. is on during VCD playback.
- To restart normal playback, press the **▶** button on the player main unit or the **▶ PLAY** button on the joystick remote.
- Audio is not output during slow playback or reverse slow playback.
- Reverse slow playback is not available with VCD.
- Slow playback and reverse slow playback are not available with CD(MP3) or DVD AUDIO containing only still pictures and audio (AOTT: Audio Only Title).

Menu playback of DVD

When a DVD containing the recording of the top menu or menu is played, the top menu or menu is displayed.

These menus allow you to select the position you want to play easily based on an interactive method. The following operation procedure is the basic procedure. The functions vary depending on certain softwares.

1. Set the mode switch of the joystick remote to the Blue position.

2. Press  to display the top menu.

- When the **TOP MENU** button is pressed again while the top menu is displayed during playback, the played position returns to the position where the button was pressed for the first time and playback restarts from there.

3. Select the scene to be played by tilting the joystick. (The scene may sometimes be selected using the numeric buttons.)

4. Press  to play the DVD from the selected title.

- To display multiple menus sequentially, repeat steps 3 and 4 above. If the menus are provided in a hierarchical structure, this operation allows you to move to the menus in the lower hierarchy level.
- When the mode switch of the joystick remote is set to the Blue position and the **MENU** button is pressed, the menu is displayed. The operation is the same as that of the top menu.

Menu playback of P.B.C.-compatible VCD

When a P.B.C. (PlayBack Control) capable VCD is played with P.B.C. on, the menu is displayed. Perform operation according to the procedure indicated by the menu. (For details on the operation method and control buttons, refer to the manual provided with the played software.)

Hierarchical structure of VCD menus

When a P.B.C.-compatible VCD containing menus is played and an item is selected in the displayed menu, a menu with more detailed items may sometimes be displayed. Such a structure in which multiple menus are distributed in different levels and interconnected is referred to as the hierarchical structure. In this structure, the target scene can be reached by repeatedly selecting items in multiple menus.

Example of hierarchical structure

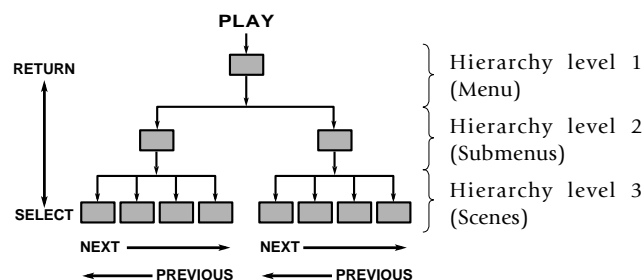

To advance in the hierarchy: When an item is selected in the menu using the **ENTER (Select)** button or numeric buttons, you can advance to the menu at the level immediately below the current level. When the selected item is a [scene], the scene will be played back.

To return in the hierarchy: You can return to the level immediately above the current level every time you press the **RETURN** button.

- When there are multiple menus (scenes) in a hierarchy level, they can be switched over by pressing the **◀◀ (Previous)** button or **▶▶ (Next)** button.

Main control buttons used in VCD playback, and examples of indications

Indication on software jacket	Control button on the player
▶ (Select)	ENTER button
⏪ (Return)	RETURN button
◀◀ (Previous)	◀◀ button
▶▶ (Next)	▶▶ button

- The indication on the jacket is variable depending on the software.

Switching P.B.C. On and Off

1. Set the mode switch of the joystick remote to the Blue position.
2. When there is a VCD in the played position of the tray and the player is in stop mode, press  to switch P.B.C. on or off.

P.B.C. on: The TV screen shows "**P.B.C. On**" and the P.B.C.-compatible VCD is played according to P.B.C. The "**P.B.C.**" indicator in the display lights up.



P.B.C. off: The TV screen shows "P.B.C. Off" and the P.B.C.-compatible VCD is played in normal playback without P.B.C.

The "P.B.C." indicator in the display turns off.

Skipping indexes in DVD AUDIO

DVD AUDIO tracks contain the recording of indexes. The following operation makes it possible to skip the currently played track index and restart playback from the next index.

1. Set the mode switch of the joystick remote to the Orange position.



2. Press  or  during playback. The same number of indexes as the number of times the button is pressed can be skipped.

- Indexes in the direction corresponding to the pressed button are skipped and the destination index is played back from the beginning.
- The display shows the index number together with the group and track numbers.

Switching still pictures of DVD AUDIO

When a DVD AUDIO (AOTT: Audio Only Title) disc containing the recording of still pictures is played, the still pictures can be displayed. (The operation may be restricted with certain discs.)

1. Set the mode switch of the joystick remote to the Purple position.

2. To switch the still pictures, press  or  during playback.

- Press the **RETURN** button to switch to the home still picture.

Switching the sequential play mode

The player is capable of sequential playback using the 5-disc carousel disc changer. If a DVD and/or VCD is mixed in the discs to be played sequentially, the sequential playback may stall in the middle while the menu remains displayed. In such a case, switch the sequential play mode of the player.

Set the sequential play mode of the player to "SEQ.2" using the joystick remote as described below. The DVD VIDEO playback will be skipped in order not to interrupt the sequential playback.

When playing a VCD with menu playback or playing a DVD VIDEO, set the sequential play mode of the player to "SEQ.1".

1. Set the player to normal play mode.  39
 - If the player is in the program or random play mode, the sequential play mode cannot be switched.

2. Set the mode switch of the joystick remote to the Purple position.

3. Each press of  switches the sequential play mode of the player alternately.

[Sequential play mode 1 ("SEQ.1" lit)]

All discs can be played including DVD VIDEO discs.

When there is a P.B.C.-compatible VCD or a DVD on the tray, sequential playback may sometimes be interrupted and the menu displayed. In this case, perform menu playback.  24

[Sequential play mode 2 ("SEQ.2" lit)]

Playback of DVD VIDEO discs is skipped in order not to interrupt sequential playback. (The display shows "SKIP DVD VIDEO" to indicate this.)

With a DVD AUDIO disc containing the recording of menu, menu playback is not available.

With a P.B.C.-compatible VCD, playback is performed by switching P.B.C. automatically to off.

- When the sequential play mode is changed, "SEQ.1" or "SEQ.2" is displayed on the TV screen and the "SEQ.1" or "SEQ.2" indicator light in the display to indicate the current sequential play mode.

Switching the time display

The information in the time display can be switched over. (The information can also be switched by the OSD operation. → )

This operation is not available in stop mode, during menu playback of DVD or with a DVD for which time display is disabled.

If P.B.C. is set to On with a VCD, set P.B.C. to Off. → 

1. Set the mode switch of the joystick remote to the Purple position.
2. Press  during playback to display the "MAIN" OSD. Each further press of the button changes the time display icons as shown below.



"**Single Time**": Elapsed play time of a track or chapter.



"**Single Remain Time**": Remaining time in a track or chapter.



"**Total Time**": Elapsed play time of a disc, group or title.



"**Total Remain Time**": Remaining time in a disc, group or title.

- The time display on the player's display is also switched accordingly. When "**Total Time**" or "**Total Remain Time**" is selected, the "**TOTAL**" indicator in the display lights up.
- In the program or random play mode, only "**Single Time**" and "**Single Remain Time**" can be switched over.
- With a MP3 disc, only the "Single Time" information is displayed.

Repeat playback

Repeat playback allows you to play the desired audio or video repeatedly. (Repeat playback is also available with the OSD operation. → )

This function may be unavailable with certain discs.

1. Set the mode switch of the joystick remote to the Purple position.

2. Press  during playback to display the "MAIN" OSD. Each further press of the button switches the repeat icons as shown.

- Repeat playback is canceled when it is stopped, except when "**All**" is selected.
- When the player is set to the repeat play mode, the "**REPEAT**" indicator in the display lights up. The character information display also shows the repeat mode information for a few seconds.
- When the player is in stop mode, only "**All**" or "**OFF**" can be selected.
- This operation is not available with a DVD with which the elapsed play time information is not displayed.

[During playback of DVD AUDIO]



: Repeat playback of the track being played.



: Repeat playback of the group being played.



: Repeat playback of the disc being played.



: Repeat playback of all discs in the tray.



: Repeat playback Off.

- "**Disc**" is displayed only when "**SEQ.2**" indicator is lit.

[During playback of DVD VIDEO]



: Repeat playback of the chapter being played.



: Repeat playback of the title being played.



: Repeat playback of all discs in the tray.



: Repeat playback Off.

[During playback of CD or VCD]



: Repeat playback of the track being played.



: Repeat playback of the disc being played.





: Repeat playback of all discs in the tray.





: Repeat playback Off.

[During playback of MP3 disc]

 : Repeat playback of the file being played.

 : Repeat playback of the folder being played.

 : Repeat playback of the disc being played.

 : Repeat playback of all discs in the tray.

 : Repeat playback Off.

[In the program mode] →  39

 : Repeat playback of programmed contents.

 : Repeat playback Off.

[In the random mode] →  40

 : Repeat playback according to the current random play mode.



 : Repeat playback Off.

A-B repeat playback

A-B repeat playback allows you to play a specified section repeatedly. (A-B repeat playback is also available with the OSD operation. →  34)

A-B repeat playback may sometimes be unavailable during playback of certain DVD.

1. Set the mode switch of the joystick remote to the Purple position.

2. Press  during playback to display the "MAIN" OSD. Repeat icon  is displayed and the current disc position is stored in memory as point A where the repeat playback is to be started.

- The "REPEAT" and "A ►" indicators in the display light up.

3. When point B where you want to stop repeat playback comes, press  again. Repeat icon  is displayed and repeat playback of the section between points A and B starts.

- The "REPEAT" and "A ► B" indicators light in the display.
- To cancel repeat playback and return to normal playback, press the **A-B REPEAT** button during A-B repeat playback. The "REPEAT" and "A ► B" indicators turn off and normal playback starts.
- This operation is not available with a DVD with which the elapsed play time information is not displayed.
- A-B Repeat playback can be used only within a same title. (DVD Video)
- A-B Repeat playback can be used only within a same track. (DVD Audio)

- This operation is not available with a MP3 disc.
- This operation is unavailable in the all-random and program modes.

Pure Audio function

It blocks the video signal to prevent interference between the video and audio signals so pure audio can be reproduced by switching the Pure Audio function On. When the video signal is blocked, the TV screen shows no picture during audio playback.

Press  on the player main unit to switch the Pure Audio function on/off.

- When you are operating the joystick remote, set the mode switch to the Blue position then press the **P.AUDIO** button.
- When the Pure Audio function is activated, the **PURE AUDIO MODE** button on the player main unit lights up. Pressing the button again switches the Pure Audio function off and turns the indicator off.
- When an operation for displaying the on-screen message (the display of the performed operation contents on the TV screen) or OSD is performed, the video signal is output temporarily.
- With some DVD and VCD discs, the menu may be displayed.

Switching the audio language

When a VCD or a DVD containing the recording of audio in multiple languages is played, the language used in the voice can be switched over. (The audio language can also be switched by the OSD operation. → [35](#))

1. Set the mode switch of the joystick remote to the Purple position.

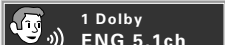
2. Press  during playback to display the "SOUND" OSD. Each further press of the button switches the displayed  (Audio icon).

- With a DVD AUDIO disc, an audio language number can be selected from up to 2 numbers.
- With a DVD VIDEO disc, an audio language number can be selected from up to 8 numbers.
- With VCD, "STEREO", "L", "R" or "L+R" can be selected.
- The default audio language set by the user is selected when the power is turned on or the disc is changed. If the default language is not contained in the disc, the priority language defined for the disc will be played back.
- The above operation is not available in stop mode. It is also unavailable with ordinary music CD(CD-R/RW)s.

Using Headphones

Connect stereo headphones (with a standard stereo phone plug) into the **PHONES** jack and adjust the volume level with the **PHONES LEVEL** knob. The player incorporates the headphone Virtual Surround facility allowing the use of surround audio through headphones. → [35](#)

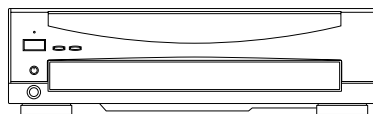

Chapter 4: OSD Operation

The operations described in this chapter allows the user to perform operations and settings by referring to the OSD (On-Screen Display). As the OSD operation uses only the specific buttons on the joystick remote, the user can enjoy the functions of the player even before memorizing the functions of all buttons. This chapter is composed of the following sections.

Basic OSD Operation →  30

"MAIN" OSD Operation →  31

"SOUND" OSD Operation →  35

"VISUAL" OSD Operation →  36

- If the on-screen message or OSD is displayed outside the TV screen when using a widescreen TV or similar monitoring device, set the "**OSD Position**" setting to "**Cinema**".
- The OSD cannot be displayed when DVD is played by menu playback. It may also be unavailable with certain discs.
- The "**SOUND**" OSD and "**VISUAL**" OSD can be displayed only in a play mode.

Basic OSD Operation

Various operations can be performed by selecting the OSD icons on the TV screen using the joystick.

1. Press  to display OSD.

"MAIN" OSD :

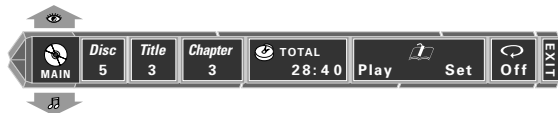

Only the "MAIN" OSD can be displayed when the button is pressed in stop mode. (The up and down arrows shown in the above figure are not displayed.)

When the button is pressed in a play mode, the OSD can be changed by tilting the joystick up or down.

"SOUND" OSD :



"VISUAL" OSD :



2. Select an OSD icon by tilting the joystick to the left or right, then press  to display the pull-down menu.

- Tilt the joystick to move the cursor. But the cursor cannot be moved to the icons of currently unavailable functions.

- The OSD includes icons with a variety of functions. The displayed icons are variable depending on the player status and played disc.
- When the cursor is located on the left or right end, if you attempt to move the cursor toward the outside, the cursor will move to the opposite end.
- To clear the OSD display, move the cursor to the **EXIT** icon and press the **ENTER** button. (The same effect can also be obtained by pressing the **ON SCREEN** button.)

3. From the displayed pull-down menu, select the desired item by tilting the joystick up or down or by setting the mode switch to the Orange position and inputting the desired item number using  to

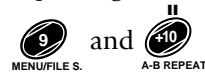

Example of pull-down menu display:

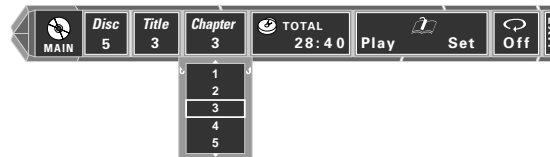





Example of menu display when a number is input:



When a group, title, chapter, track, folder, or file number is input using numeric buttons, the pull-down menu display changes and the input number blinks in it. (The figure on the right of the input number shows the number of chapters in the disc.)

If you commit a mistake in the numeric button input, press the **C** button and restart the input from the beginning.

- When  and  are displayed on the top and bottom of the pull-down menu, the menu has more pages above or below the current page. When the cursor is located on the bottom edge, tilting the joystick downward makes it possible to advance to the next page. (When the cursor is located on the top edge, tilting the cursor upward makes it possible to return to the previous page.)
 - "" and "" on the left and right edges of pull-down menu indicates that tilting the joystick toward the left or right makes it possible to clear the pull-down menu and move the cursor to the originally pressed icon. (The same effect is also available by pressing the **RETURN** button.)
4. Press  to enter the selection in memory.
 - The OSD icon display varies depending on the content of change.

"MAIN" OSD Operation

This section describes the display contents and controllable items of the "MAIN" OSD. (Note that certain items may not be controllable depending on the played disc and player status.)

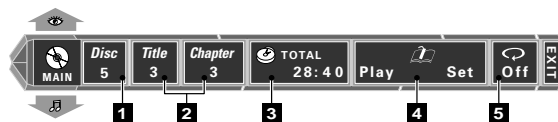

- 1 Disc icon:** Shows the disc number. Select to change the disc. → [31](#)
- 2 Group icon:** Shows the group number in DVD AUDIO disc.
Track icon: Shows the track number in DVD AUDIO, VCD or CD disc.
Folder icon: Shows the folder number in MP3 disc.
Title icon: Shows the title number in DVD VIDEO disc.
Chapter icon: Shows the chapter number in DVD VIDEO disc.
File icon: Shows the file number in MP3 disc.
 Select an icon to change its content. → [31](#)
- 3 Time display icon:** Shows the disc time. Select to perform time search or change the time display. → [32](#)
- 4 Memory Play/Memory Set icon:** Select to register or recall memory. → [33](#)
- 5 Repeat icon:** Shows the repeat mode. Select to use repeat play mode. → [33](#)

Selecting the disc to be played

Use the following procedure to select a new disc to be played using OSD. (The disc can also be selected directly by pressing the **DISC SKIP** button or one of the **DISC 1** to **5** buttons. → [22](#))

1. Press to display the "MAIN" OSD.
2. Move the cursor to the (Disc icon) by tilting the joystick to the left or right, then press .
 - This operation is not available in the all random and program mode.
3. Select the disc number by tilting the joystick up or down, then press to start playback.

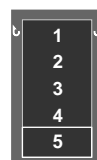

The cursor is displayed on the currently selected disc number.

Selecting a group, title, chapter, track, folder or file

Use the following procedure to select a new group, title, chapter or track to be played using OSD. (They can also be selected directly by pressing the numeric buttons or a buttons. → [22](#))

When performing this operation with a P.B.C.-compatible VCD, set P.B.C. to off. → [24](#)

1. Press during playback to display the "MAIN" OSD.

2. Move the cursor to the "**Group**", "**Title**", "**Chapter**", "**Track**", "**Folder**", or "**File**" icon by tilting the joystick to the left or right, then press .

DVD AUDIO: Select or

DVD VIDEO: Select or

CD, VCD : Select

MP3 disc: Select or

3. Select the number by tilting the joystick up or down, then press to start playback.



During playback, the cursor is located on the current group, title, chapter, track, folder or file number. (In this figure, the last number can be displayed by tilting the joystick upward.)

The number can also be selected by setting the mode switch of the joystick remote to the Orange position and composing the number with numeric buttons.

- Only the title or group icon can be selected in stop mode of DVD.

Time display switching and time search

Use the following procedure to switch the type of information shown by the time display shown in the OSD or player display. Time search is also available for specifying the position to start playback by inputting the time information. (The time display information type can also be changed using the **TIME DISP.** button. → 26)

Time search is not available in stop mode, during menu playback of a DVD or with a DVD VIDEO which does not provide the time display.

When performing this operation with a P.B.C.-compatible VCD, set P.B.C. to off. → 24

1. Press during playback to display the "MAIN" OSD.

2. Move the cursor to (Time Display icon) by tilting the joystick to the left or right, then press .

3. Select the type of time display information by tilting the joystick up or down, then press . If time search is required, move the cursor to the time display icon to select the type of time display information, then perform the operations in steps 4 and 5.



"-- : -- : --" : The time search target time can be input. ("-- : -- : --" is displayed with a CD or VCD.)

"**Single Time**": Elapsed play time of track, chapter, or file.

"**Single Remain Time**": Remaining play time of track, chapter or file.

"**Total Time**": Elapsed play time of disc, group or title.

"**Total Remain Time**": Remaining play time of disc, group or title.

- Time search is not available in the program and random modes. The time display can be switched between "**Single Time**" and "**Single Remain Time**".
- The time display icon in the OSD and the time display in the player display varies according to the change.
- When "**Total Time**" or "**Total Remain Time**" is selected, the "**TOTAL**" indicator in the display light up.

4. Set the mode switch of the joystick remote to the Orange position.

5. Input the time to start playback using to , then press .

Input examples:

1 hr. 05 min. 00 sec. (with a DVD):



65 min. 00 sec. (with a CD or VCD):



1 min. 28 sec.:

- If you commit a mistake in the numeric button input, press the **C** button and restart the input from the beginning.
- This operation is not available with a MP3 disc.

Memory playback





When you register a scene you like in memory, you can start playback from that scene any time you want. Up to 10 scenes can be registered in memory.

Memory registration and deletion are not available during menu playback of DVD or with a DVD VIDEO for which time display is disabled.

When performing this operation with a P.B.C.-compatible VCD, set P.B.C. to off. → 

This function may be unavailable with certain discs.

Registering a scene in memory

1. Press  during playback to display the "MAIN" OSD.
2. Move the cursor to  (Memory Set icon) by tilting the joystick to the left or right, then press .
3. Select the memory number to be used in registration by tilting the joystick up or down, then press  when the scene to be registered comes.





Disc	Tl/Grp/Trk	Time
1	4 1	0 : 0 8 : 2 8
2	- -	- : - : - -
3	- -	- : - : - -
4	- -	- : - : - -

The memory numbers in which scenes have already been registered show the disc number, title, group or track number and the time. Memory numbers 5 to 10 are displayed on the next display page.

- The displayed time value is the accumulated count since second 0 of the first track in the same group.
- Up to 10 scenes can be registered in memory.
- When a number in which a scene has already been registered is selected, the scene will overwrite the existing memory.

- To delete a scene from memory, set the mode switch of the joystick remote to the Orange position, select the memory number and press the **C** button.
- The memory of the disc at the disc replacement position of the tray is cleared when the power is turned off or standby or the tray is opened.
- This operation is not available with a MP3 disc.





Recalling memory

1. Press  to display the "MAIN" OSD.
2. Move the cursor to  (Memory Play icon) and press .
3. Select the memory number of the scene to be recalled by tilting the joystick up or down, then press .

Repeat playback

Desired video and audio can be played repeatedly. However, with some DVDs and VCDs, the partitions in the recording are not related with the track number assignment. As a result, repeat playback may not be available with such software. (The same effect can also be obtained directly by pressing the **REPEAT** button. → )

This function may be unavailable with certain discs.

1. Press  during playback to display the "MAIN" OSD.
2. Move the cursor to  (Repeat icon) by tilting the joystick to the left or right, then press .
3. Select the repeat mode by tilting the joystick up or down, then press .
 - Repeat playback is canceled when it is stopped, except when "All" is selected.
 - When the repeat mode is changed, the repeat icon varies according to the change. When the player is set to a repeat play mode, the "REPEAT" indicator in the display lights up and the character information display also shows the repeat mode information for a few seconds.
 - When the player is in stop mode, only "All" or "OFF" can be selected.
 - This operation is not available with a DVD with which the elapsed play time information is not displayed.

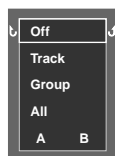
[During playback of DVD AUDIO]

"**Off**": Repeat playback off.

"**Track**": Repeat playback of the track being played.

"**Group**": Repeat playback of the group being played.

- "**Disc**" is displayed only when "**SEQ.2**" indicator is lit.

"**All**": Repeat playback of all discs in the tray.

"**A**": A-B repeat playback.

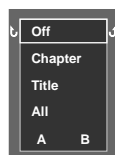
[During playback of DVD VIDEO]

"**Off**": Repeat playback off.

"**Chapter**": Repeat playback of the chapter being played.

"**Title**": Repeat playback of the title being played.

"**All**": Repeat playback of all discs in the tray.

"**A**": A-B repeat playback.

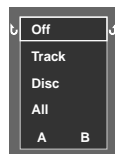
[During playback of CD or VCD]

"**Off**": Repeat playback off.

"**Track**": Repeat playback of the track being played.

"**Disc**": Repeat playback of the disc being played.

"**All**": Repeat playback of all discs in the tray.

"**A**": A-B repeat playback.

[During playback of MP3 disc]

"**Off**": Repeat playback off.

"**File**": Repeat playback of the file being played.

"**Folder**": Repeat playback of the folder being played.

"**Disc**": Repeat playback of the disc being played.

"**All**": Repeat playback of all discs in the tray.

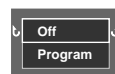
[In the program mode] → 39

"**Off**": Repeat playback off.

"**Program**": Repeat playback of programmed contents.

[In the random mode] → 40 → 41

"**Off**": Repeat playback Off.

"**Random**": Repeat playback according to the current random play mode.

A-B repeat playback

A-B repeat playback allows you to play a specified section repeatedly. (A-B repeat playback is also available by pressing the **A-B REPEAT** button. → 27)

A-B Repeat playback may sometimes be unavailable during playback of certain DVD.

1. Perform the repeat playback procedure steps 1. and

2. → 27

2. Select "**A**" by tilting the joystick up or down, then press . The current disc position is stored in memory as point A where the repeat playback is to be started and the cursor is moved to "**B**".

- The Repeat icon changes to "**A**" and the "**REPEAT**" and "**A ▶**" indicators in the display light up.

3. When point B where you want to stop repeat playback comes, press again. Repeat playback of the section between points A and B starts.

- The Repeat icon changes to "**A B**" and the "**REPEAT**" and "**A ▶ B**" indicators light in the display.

- To cancel repeat playback, select "**Off**".

- This operation is not available with a DVD with which the elapsed play time information is not displayed.

- A-B Repeat playback can be used only within a same title. (DVD Video)

- A-B Repeat playback can be used only within a same track. (DVD Audio)

- This operation is not available with a MP3 disc.

- This operation is not available in the all random and program mode.

"SOUND" OSD Operation

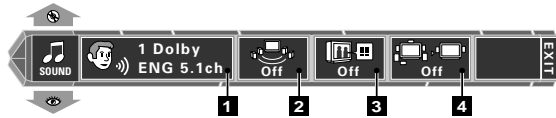

This section describes the items which can be controlled with the "SOUND" OSD. (Some items may be uncontrollable depending on the played disc and player status.)



- 1 Audio icon:** Shows the audio signal, audio language and number of audio channels. Select to switch the audio language. → [35](#)
- 2 Virtual Surround icon:** Shows the level of the Virtual Surround effect. Select to adjust the level of Virtual Surround or switch it off. → [35](#)
- 3 Cinema voice icon:** Shows the on/off status of Cinema Voice. Select to switch Cinema Voice on or off. → [35](#)
- 4 Down Mix icon:** Shows the on/off status of Down mix. Select to switch Down mix on or off. → [36](#)

Switching the audio language

When a VCD or a DVD containing the recording of audio in multiple languages is played, the language used in the voice can be switched over. (The audio language can also be switched directly by pressing the **AUDIO** button. → [28](#))





1. Press  during DVD playback and select the "SOUND" OSD by tilting the joystick up or down.
2. Move the cursor to  (Audio icon) by tilting the joystick to the left or right, then press .

3. Select the desired audio language number by tilting the joystick up or down, then press .

- With a DVD AUDIO disc, an audio language number can be selected from up to 2 numbers.
- With a DVD VIDEO disc, an audio language number can be selected from up to 8 numbers.
- With VCD, "STEREO", "L", "R" or "L+R" can be selected.
- The default audio language set by the user is selected when the power is turned on or the disc is changed. If the default language is not contained in the disc, the priority language defined for the disc will be played back.

Virtual Surround function

When playing a DVD recorded with Dolby Digital Surround audio, powerful sound can be reproduced even when you use headphones or only two speakers.

1. Press  during DVD playback, and select the "SOUND" OSD by tilting the joystick up or down.
2. Move the cursor to  (Virtual Surround icon) by tilting the joystick to the left or right, then press .
 - The icon can be selected only when the played software is recorded in Dolby Digital audio (with 2 or more channels).
3. Select the level of Virtual Surround effect by tilting the joystick up or down, then press .

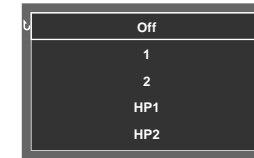





The effect is increased when the selected level is higher. Select "Off" to switch the effect Off. To select the level of the Virtual Surround effect through headphones, select "HP1" or "HP2".

- When a DVD recorded with Dolby Digital audio (with 2 or more channels) is played, the "DOLBY DIGITAL" indicator on the player main unit lights up.

Cinema Voice function





This function to be used when words are hard to be distinguished during playback of DVD recorded with Dolby Digital Surround, Dolby Digital, DTS, or DVD Audio LPCM. To use this function, it is required that the disc being played provides the center channel audio.

- When the digital output terminal is used, the "Digital Audio" setting should be set to "PCM" or "Off". → [54](#)
1. Press  during playback of DVD, then select the "SOUND" OSD by tilting the joystick up or down.
 2. Move the cursor to  (Cinema Voice icon) by tilting the joystick to the left or right, then press .
 - The icon can be selected only when the played software is recorded in Dolby Digital audio (with center channel).
 3. Select on or off by tilting the joystick up or down, then press .

Down Mix function

This function is available with a DVD containing the recording of multi-channel audio.

This function converts the multi-channel audio into 2-channel audio and outputs the converted signals.

1. Press  during playback of DVD, then select the "SOUND" OSD by tilting the joystick up or down.
2. Move the cursor to  (Down Mix icon) by tilting the joystick to the left or right, then press .
3. Select "on" or "off" by tilting the joystick up or down, then press .

"VISUAL" OSD Operation



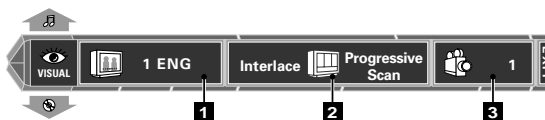

This section describes the items which can be controlled with the "VISUAL" OSD. (Some items may be uncontrollable depending on the played disc and player status.)



- 1 **Subtitle icon:** Shows the language used in subtitles. Select to change the subtitle language (→ [36](#)). During playback of a DVD-AUDIO disc containing the recording of still pictures (ASV ; Audio Still Video), the Sub-title icon shows the still image display information (display timing, image display sequence, etc.).
- 2 **Picture quality icon:** Shows the current picture quality. Select to adjust the picture quality. → [36](#)
- 3 **Angle icon:** Shows the angle number. Select to change the viewing angle. → [37](#)

Switching the subtitle language

When a DVD contains recording of subtitles in multiple languages, the desired subtitle language can be selected.

1. Press  during playback of DVD, and select the "VISUAL" OSD by tilting the joystick up or down.
2. Move the cursor to  (Subtitle icon) by tilting the joystick to the left or right, then press .
3. Select the desired subtitle language number by tilting the joystick up or down, then press .

- The desired subtitle language number can be selected from up to 32 numbers.
- No subtitle is displayed when "Off" is selected. When the desired language is not included in the options, the language is not recorded in the disc.
- The default subtitle language set by the user is selected when the power is turned on or the disc is changed. If the default language is not contained in the disc, the priority language defined for the disc will be played.

Adjusting the picture quality



Use the following procedure to adjust the picture quality. (If the desired picture quality cannot be obtained by the following operation, adjust it on the TV.)

The setting items vary depending on the position of the **COMPONENT VIDEO OUTPUT** switch on the rear of the player.

When "Interlace" is set → [36](#)

When "Progressive" is set → [37](#)

When "Interlace" is set

1. Press  during playback, then display the "VISUAL" OSD by tilting the joystick up or down.
2. Move the cursor to  (Picture quality adjustment icon) by tilting the joystick to the left or right, then press .

When "Progressive" is set

1. Press 

Chapter 5: Applied Operations

This chapter gives descriptions on the special playback operation, character display of TEXT DISC (CD-TEXT or DVD TEXT) and headphones operation.

This chapter is composed of the following sections.

Switching the Play Modes -  39

Program Playback -  39

Disc Random Playback -  40

All Random Playback -  41

TEXT DISC Operation -  41

MP3 disc Operation -  42

Switching the "DVD VIDEO Mode" -  43

Bonus Group -  43

Switching the Play Modes

The play modes of the player include the program mode, disc random mode and all random mode in addition to the track mode for normal playback.

However, with some DVDs and VCDs, the partitions in the recording are not related with the track number assignment. As a result, repeat playback may not be available with such software.



1. Set the mode switch of the joystick remote to the Orange position.
2. While the player is in stop mode, each press of

7. Select **Play** in the screen using the joystick, then press



 to start program playback.

- When the mode switch of the joystick remote is set to the Blue position and **▶▶** is pressed, the current track is skipped and the next track in the program will be played.
- Even when a disc is changed during programming, the program playback plays the disc and track numbers as registered with the previous disc. In this case, the programming should be restarted from the beginning.

Clearing the program

1. Perform operations in steps 1 and 2 of the procedure in "**Registering and playing the program**". → 
2. Move the cursor to **Last Clear** or **All Clear** in the screen, then press .
 - Every time "**Last Clear**" is selected, the last track in the program list is cleared. (The program can also be cleared by pressing the **C** button.)
 - When "**All Clear**" is selected, all tracks in the entire program list are cleared.

Stopping program playback

Perform operations in steps 1 and 2 of the procedure in "**Registering and playing the program**", then press  repeatedly until the player enters normal play mode (track mode). → 

- The "**PGM**" indicator turns off

Checking the program

Set the mode switch of the joystick remote to the Purple position and press  during program playback.

- The program list is displayed on the TV screen. When a program number is selected by tilting the joystick up or down and the **ENTER** button is pressed, program playback starts from the selected program number. The contents of the program numbers are also shown on the player display. (A program number can also be selected by pressing the **CHECK** button to move the cursor in the program list.)
- When 17 or more tracks are programmed, the program list is displayed in more than one page. In this case, when the cursor is located on the bottom edge, tilting the joystick downward makes it possible to advance to the next page. (When the cursor is located on the top edge, tilting the cursor upward makes it possible to return to the previous page.)

Disc Random Playback

Tracks in a desired disc can be played back in a random order. (Disc random playback is not available with DVD VIDEO, MP3 disc.)

1. Set the mode switch of the joystick remote to the Orange position.

2. While the player is in stop mode, press  repeatedly until the player enters the disc random mode.



- When the player enters the disc random mode, the screen as shown in the figure appears and the "**RANDOM**" indicator in the display lights to indicate that the player is in the disc random mode.
3. Select the disc by tilting the joystick to the left or right, then press  to start disc random playback.
 - Disc random playback can also be started by pressing the **▶ PLAY** button.

Stopping disc random playback

Switching the character information

When a TEXT DISC is played, the displayed character information can be switched over.

1. Set the mode switch of the joystick remote to the Purple position.
2. Each press of  displays the character information by scrolling then switches it.

Order of information in stop mode:

① Disc Title → ② Disc Artist → ③ Maximum track number and total time display.

With DVD TEXT

① Disc Title → ② Disc Artist → ③ "STOP"

(If the button operation is stopped while information ② is displayed, information ① is displayed again.)

Order of information in play mode:

① Track Title → ② Track Artist → ③ Disc Title, Group Title → ④ Title Artist, Group Artist → ⑤ Disc Title → ⑥ Disc Artist → ⑦ Track No. being played, time information. (If the button operation is stopped while information ②, ③ or ⑥ is displayed, information ① is displayed again.)



With DVD VIDEO TEXT

① Chapter Title → ② Chapter Artist → ③ Title Title → ④ Title Artist → ⑤ Disc Title → ⑥ Disc Artist



- When the disc contains a part without character information, the display shows "----".
- This operation is not available when the FL Mode is set to "FL OFF" by the **DISPLAY** button. → 

Displaying all character information

When a TEXT DISC is played, all character information recorded in the disc can be displayed at once.

1. Set the player in normal play mode. → 
2. Set the mode switch of the joystick remote to the Purple position.
3. Press  to display the character information items in the order shown below. Pressing the button while an information item is displayed advances to the next item.

① Title → ② Artist → ③ Songwriter → ④ Composer → ⑤ Arranger → ⑥ Message → ⑦ ID INFO. (record company, date of release, etc.) → ⑧ Genre INFO. → ⑨ ALL INFO. END (end of information display)

- When the mode switch of the joystick remote is set to the Blue position, pressing the  or  button skips the information of the previous or next track.
- Information items ① to ⑥ are displayed in order of disc, group or track. (The group information is not displayed with CD TEXT.)
- Information items ③ to ⑤ are not displayed with DVD VIDEO TEXT.
- When information item ⑨ has been displayed, the player returns to the original status. The character information display is canceled when any other button is pressed during display.
- If the played disc is not a TEXT DISC, the display shows "NO TEXT DISC" for 5 seconds to indicate that this operation is not possible. An information item which is not recorded is displayed as "-----".
- This operation is not available when the FL Mode is set to "FL OFF" by the **DISPLAY** button. → 

MP3 disc Operation

Switching the character information

When a MP3 disc is played, the displayed character information can be switched over.

1. Set the mode switch of the joystick remote to the Purple position.
2. Each press of  displays the character information by scrolling then switches it.

Order of information in play mode:

① File Title → ② Folder Title → ③ Disc Title → ④ File Number

- The "All character information" function is not available with a MP3 disc.

Searching a desired folder/file by its title

MP3 files can be searched based on the title of the file or the folder containing the file.

1. Set the mode switch of the joystick remote to the Blue position.

- The maximum number of folders or files that can be searched is 999. Folders or files exceeding this number cannot be searched.

2. Press the  button.

- If file search is required, press the  button instead.

3. Select the desired folder or file by tilting the joystick up or down, then press .

4. Press the .

- In folder search, playback begins with the file with the minimum file number in the searched folder.
- In file search, playback begins with the searched file.

Switching the "DVD VIDEO Mode"

When playing a disc in which DVD VIDEO and DVD AUDIO are mixed, this setting makes it possible to select whether the DVD VIDEO part or DVD AUDIO part is to be played. To reproduce only the DVD VIDEO part, set this item to "On".

At the factory, the player has been set to "Off" with which the DVD AUDIO part is played back.



Setting items

"↩" : Select to return to the previous screen.

"On" : Select to play only the DVD VIDEO part in a DVD VIDEO/DVD AUDIO mixed disc.

"Off" : Select to play only the DVD AUDIO part in a DVD VIDEO/DVD AUDIO mixed disc.

Operation procedure

1. Set the mode switch of the joystick remote to the Purple position.
2. While the player is in stop mode, press  to display the "MAIN" menu of "SET UP MENU".
3. Press  to open the setup screen.
4. In the setup screen, select "DVD VIDEO Mode" by tilting the joystick up or down and press .

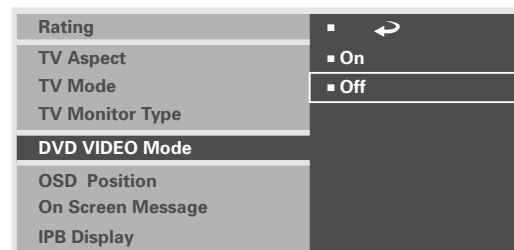

5. Select "On" or "Off" by tilting the joystick up or down, then press  to enter the selection in memory.

- This setting is reset to default "Off" when the disc is changed or the power is set to off or standby.

Bonus Group

In addition to ordinary groups, some DVD AUDIO discs provide information hidden in a special group as a user service. When this group is selected, the password input screen appears on the TV screen to inform the user of the presence of the bonus group in the disc. The bonus group can be played by inputting the password. (For the registration of password, consult the software producer.)



1. Set the mode switch of the joystick remote to the Orange position.

2. Input the password using  to , then press  to start playback of the bonus group.

Chapter 6: Various Setups

This chapter describes the setup operations of the player according to the connected components. Most of the operations described below can be performed using the provided standard remote control unit.

This chapter is composed of the following sections.

SET UP/MAIN

"Rating"	→ 47
"TV Aspect"	→ 49
"TV Mode"	→ 49
"TV Monitor Type"	→ 50
"DVD VIDEO Mode"	→ 51
"OSD Position"	→ 51
"On Screen Message"	→ 52
"IPB Display"	→ 53

SET UP/SOUND

"Digital Audio"	
"PCM Down Conversion"	→ 54
"Dolby"	→ 54
"DTS"	→ 55
"MPEG"	→ 56
"Speaker Setting"	→ 56
"Audio During Search"	→ 60
"Dynamic Range Control"	→ 60
"Audio Filter"	→ 61

SET UP/VISUAL

"Player Menu Language"	→ 62
"Disc Menu Language"	→ 62
"Audio Language"	→ 63
"Subtitle Language"	→ 64
"Still Mode"	→ 64
"FL Mode"	→ 65
"NTSC → PAL" (For Europe and U.K.)	→ 66
"SCART Output Select" (For Europe and U.K.)	→ 66
"Black Level Setup (Except for Europe and U.K.)	→ 67
Disc Language Code Table	→ 68

Control Buttons Used in Setups

SET UP button: Press to display the "SET UP MENU". (Set the mode switch to the Purple position before pressing this button.)

Joystick: Tilt the joystick in the 4 directions of up, down, left and right to move the cursor to the desired point.

ENTER button: After moving the cursor to the desired point, press the **ENTER** button to enter the point and display the next setup screen.

RETURN button: Press to return to the previous setup screen.

Numeric buttons, C button: Use these buttons to input a figure using numeric buttons or to clear an input with the **C** button. (Set the mode switch to Orange position before pressing any of these buttons.)

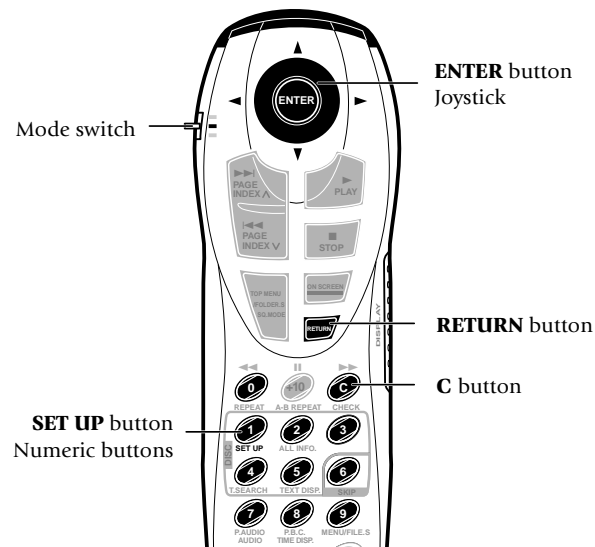

Basic Operations in Setup Screen

The "SET UP MENU" includes the "MAIN", "SOUND" and "VISUAL" menus. When a setup screen is displayed, select the desired item according to the purpose.

If the power is turned off while the setup screen remains displayed after setting changes, the changes will be invalid. Be sure to close the setup screen before turning power off.

1. Set the mode switch of the joystick remote to the Purple position.
2. Press  to open the "SET UP MENU" in which "MAIN" is displayed.

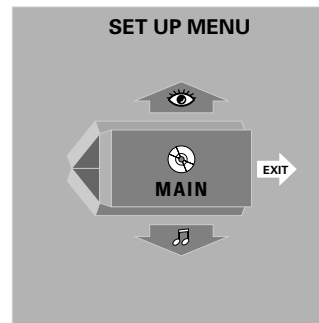

Tilt the joystick up or down to switch the displayed menu name to "SOUND" or "VISUAL".

- When you press the **RETURN** button or tilt the joystick in the direction of arrow "EXIT" while the "SET UP MENU" screen is displayed, the setup mode can be canceled.
3. Press  to open the setup screen.
 - While a setup screen is displayed, tilting the joystick toward "EXIT" allows the setup mode to be canceled and tilting it toward "MENU" returns to the "SET UP MENU".

4. Select the desired item by tilting the joystick in the required direction, then press  to open the setup change screen.

5. Select a setting by tilting the joystick in the required direction and press  to enter the change in memory.

- Press the **RETURN** button or tilt the joystick to the left to return to the setup screen.

For actual setup operations, see page 47 and after.

When "MAIN" is selected in "SET UP MENU":

The setups according to the connected TV, viewing restriction, DVD VIDEO mode, OSD position, on-screen messages and IPB display can be set.

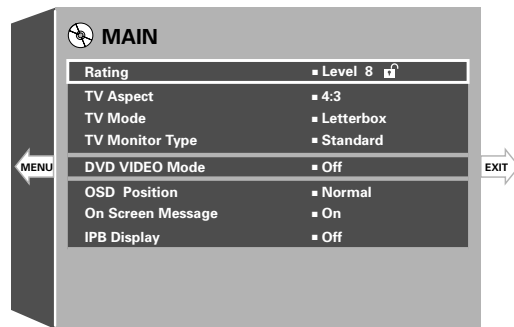
**"Rating" Setting** → 47

- Sets the viewing restriction of DVD VIDEO. (This functions only with DVD VIDEO discs compatible with viewing restriction.)

"TV Aspect" Setting → 49

- Sets the picture aspect ratio according to that of the connected TV.

"TV Mode" Setting → 49

- This setting is required when the aspect ratio of the connected TV is 4:3.

"TV Monitor Type" Setting → 50

- Set this item according to the format of the connected TV or video monitor.

"DVD VIDEO Mode" Setting → 51

- Sets the play mode of DVD discs.

"OSD Position" Setting → 51

- Sets the position of the OSD (On-Screen Display).

"On Screen Message" Setting → 52

- Switches the on-screen message on/off.

"IPB Display" Setting → 53

- Switches the IPB display on/off.

When "SOUND" is selected in "SET UP MENU":

"SOUND" is to be selected when you want to set the audio output method when system components are connected using the digital audio output connector of the player.

When the system is connected using the **6CH. OUTPUT** jacks of the player, also select "SOUND" to set the speakers, audio output during DVD or VCD search, dynamic range control function and audio filters.

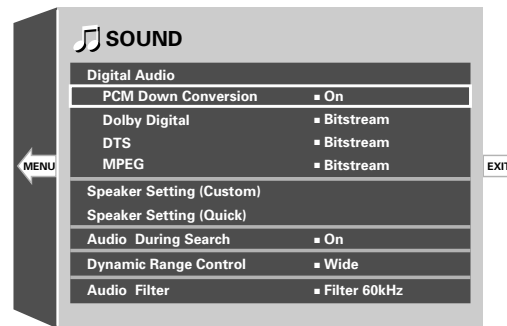
**"Digital Audio PCM Down Conversion" Setting** → 54

- Switches on/off the down-sampling conversion for the digital signal output with a high sampling rate.

"Digital Audio Dolby Digital" Setting → 54

- Sets the Dolby Digital output.

"Digital Audio DTS" Setting → 55

- Sets the DTS output.

"Digital Audio MPEG" Setting → 56

- Sets the MPEG output.

"Speaker Setting" → 56

- This setting is required when the **6CH. OUTPUT** jacks of the player is used in system connection.

"Audio During Search" Setting → 60

- Switches on/off the audio during search.

"Dynamic Range Control" Setting → 60

- Switches the dynamic range control function.

"Audio Filter" Setting → 61

- Sets the audio filters for protecting the connected speakers.

When "VISUAL" is selected in "SET UP MENU":

Select "**VISUAL**" when you want to change the language used to display the menu screens, language use in menus on the disc, audio language, subtitle language, etc.

Also select "**VISUAL**" to set the still mode, FL mode, video format conversion system or TV SCART connector output signals.

For Europe and U.K.

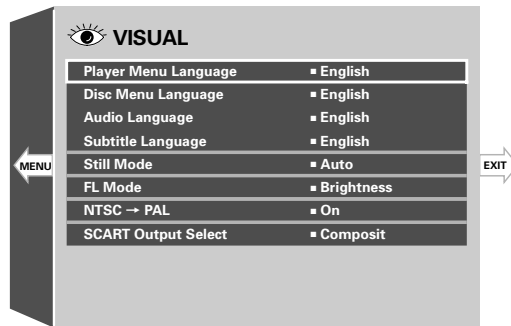

Except for Europe and U.K.

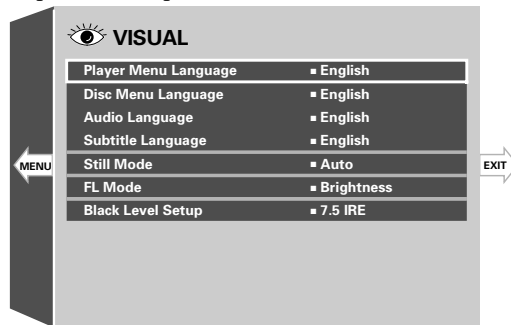

- The "**NTSC -> PAL**" and "**SCART Output Select**" settings are not displayed in certain countries and areas.

"Player Menu Language" Setting--⁶²

- Sets the language used to display the menu screens of the player.

"Disc Menu Language" Setting--⁶²

- Sets the language used to display the menu screens of the disc.

"Audio Language" Setting--⁶³

- Sets the language of the disc audio.

"Subtitle Language" Setting--⁶⁴

- Sets the language of the disc subtitles.

"Still Mode" Setting--⁶⁴

- Reduces blur in still images.

"FL Mode" Setting--⁶⁵

- Sets the brightness of the FL display. (on the player front panel.)

"NTSC -> PAL" Setting--⁶⁶

- Switches if the signal from an NTSC format disc is to be converted into PAL or not.

"SCART Output Select" Setting--⁶⁶

- Switches the output signals from the TV SCART connector of the player.

"Black Level Setup" Setting--⁶⁷

- This function makes the adjustment of the black level. Set to your preference and monitor's ability.

"MAIN" Setting

"Rating" Setting

This setting makes it possible to inhibit the playback of adult DVD videodiscs that you do not want the children to view. However, there are some discs which carries an X-rating indication on the jacket but do not contain recording of the viewing restriction label. With such discs, the viewing restriction of the player is invalid and playback cannot be inhibited.

The default setting is "**Level 8**" which means no restriction. When you change the restriction level for the first time, you will also be requested to register a password.

Setting items

"↶": Select to return to the previous screen.

"**8 No Limit**": Select to enable playback of any DVD discs whether their targets are adults, general public or children.



"**7**" to "**1**": When DVD software containing the recording of restriction level (an adult-oriented disc or a disc including violence), playback is restricted in accordance with the restriction level.

"**0 Lock All**": Select to inhibit any DVD. Use this setting for example when you want to inhibit playback of an adult-oriented DVD which does not contain the restriction information.

"**Change Password**": Select to change the viewing restriction password which has been registered before. (This item cannot be selected unless a password has already been registered.)

"Temporary Unlocked": Select to disable temporarily the viewing restriction which has been set previously. (This item cannot be selected unless a password has been set previously.)

Operation procedure

1. Set the mode switch of the joystick remote to the Purple position.
2. While the player is in stop mode, press  to display the "MAIN" menu of "SET UP MENU".
3. Press  to open the setup screen.
4. In the setup menu, select "Rating" by tilting the joystick up or down and press .

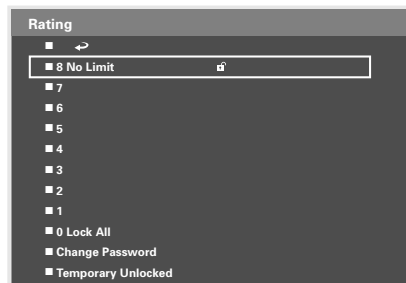

5. Select a viewing level by tilting the joystick up or down, then press  to display the password input screen.

- See "Input of Password".

Input of Password

When no password has been set previously:

- ① In step 5, the password input screen as shown below appears. Now, set the mode switch of the joystick remote to the Orange position, compose the password using the numeric buttons and press the **ENTER** button.

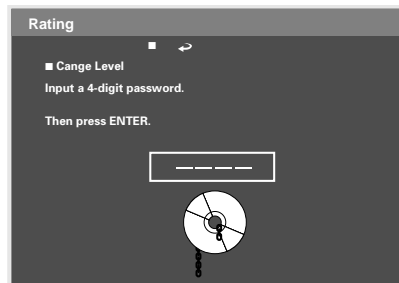

- When "↔" in the screen is selected and the **ENTER** button is pressed, the display returns to the setting screen. (This effect can also be achieved by pressing the **RETURN** button or tilting the joystick toward the left.)

- ② The password input screen changes to the confirmation screen, and the input password is shown on the TV screen.

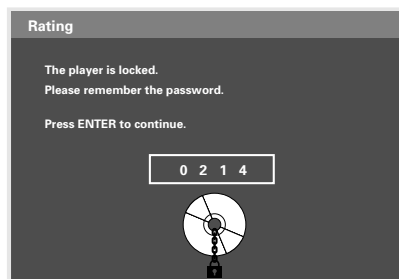

- ③ Note the password in a memo and retain it in a safe place before pressing the **ENTER** button. The password is required when setting the viewing restriction.

When a password has already been set:

In step 5, the password input screen as shown below appears. Now set the mode switch of the joystick remote to the Orange position, input the password using the numeric buttons and press the **ENTER** button.

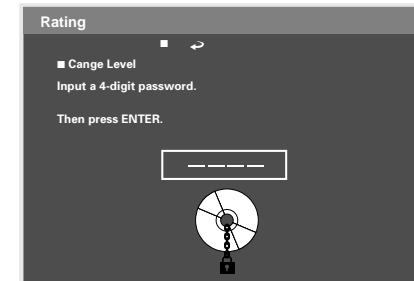

- When "↔" in the screen is selected and the **ENTER** button is pressed, the display returns to the setting screen. (This effect can also be achieved by pressing the **RETURN** button or tilting the joystick toward the left.)

If you select "**Change Password**", the screen for input of the new password will open. Input the new password using the numeric buttons and press the **ENTER** button. When the password confirmation screen appears, note the password in a memo and retain it in a safe place then pressing the **ENTER** button.

"TV Mode" Setting

When the connected TV has a 4:3 aspect ratio while the played software is recorded in widescreen video, the mode of TV screen display can be selected.

At the factory, the player has been set to "**Letterbox**".

Setting items

"↩" : Select to return to the previous screen.

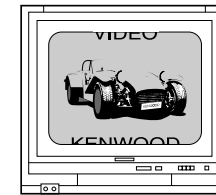

"**Pan & Scan**" : Select to play widescreen software with pan & scan specification on a pan & scan screen (screen with the left and/or right edges cut off). When widescreen software without pan & scan specification is played with this setting, it will be reproduced in the Letterbox screen mode.



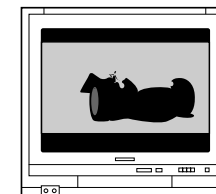

"**Letterbox**" : Widescreen software without pan & scan specification is reproduced in the Letterbox screen (screen with black bands on the top and bottom).

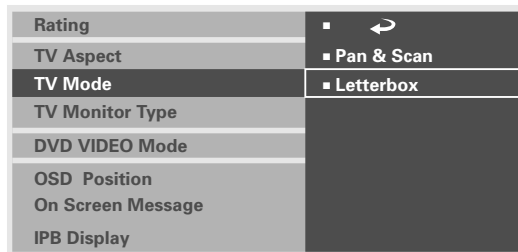

Operation procedure

1. Set the mode switch of the joystick remote to the Purple position.
2. While the player is in stop mode, press  to display the "MAIN" menu of "SET UP MENU".
3. Press  to open the setup screen.
4. In the setup menu, select "TV Mode" by tilting the joystick up or down and press .



5. Select a TV screen mode by tilting the joystick up or down, then press  to enter the selection in memory.

"TV Monitor Type" Setting

This setting adjusts the picture quality according to the type of the connected TV. If you use a means of display other than ordinary CRT TV, such as a video monitor or projector, you can adjust this setting according to your taste.

At the factory, the player has been set to "Standard" for using a CRT-based TV.

Setting items

"": Select to return to the previous screen.

"Standard": Select when connecting a CRT-based TV. Usually select this item.



"CRT Projector": Select when connecting a 3-tube front projector.

"LCD Projector": Select when connecting a LCD front projector.

"Projection TV": Select when connecting a projection TV.

"PDP": Select when connecting a plasma display panel.

Operation procedure

1. Set the mode switch of the joystick remote to the Purple position.
2. While the player is in stop mode, press  to display the "MAIN" menu of "SET UP MENU".
3. Press  to open the setup screen.
4. In the setup menu, select "TV Monitor Type" by tilting the joystick up or down and press .

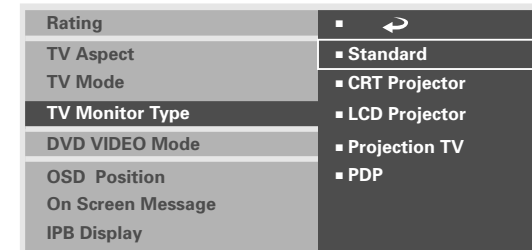

5. Select a monitor type by tilting the joystick up or down, and press  to enter the selection in memory.

"DVD VIDEO Mode" Setting

When playing a disc in which DVD VIDEO and DVD AUDIO are mixed, this setting makes it possible to select whether the DVD VIDEO part or DVD AUDIO part is to be played. To reproduce only the DVD VIDEO part, set this item to **"On"**.

At the factory, the player has been set to **"Off"** with which the DVD AUDIO part is played back.



Setting items

"↶" : Select to return to the previous screen.

"On" : Select to play only the DVD VIDEO part in a DVD VIDEO/DVD AUDIO mixed disc.

"Off" : Select to play only the DVD AUDIO part in a DVD VIDEO/DVD AUDIO mixed disc.

Operation procedure

1. Set the mode switch of the joystick remote to the Purple position.
2. While the player is in stop mode, press  to display the **"MAIN"** menu of **"SET UP MENU"**.
3. Press  to open the setup screen.
4. In the setup menu, select **"DVD VIDEO Mode"** by tilting the joystick up or down and press .

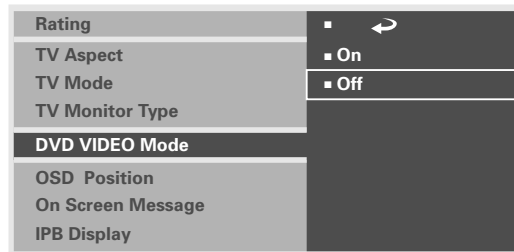

5. Select **"On"** or **"Off"** by tilting the joystick up or down, then press  to enter the selection in memory.
 - This setting is reset to default **"Off"** when the disc is changed or the power is set to off or standby.

"OSD Position" Setting

When the connected TV is a widescreen TV, the OSD (On-Screen Display) or on-screen messages may be displayed incorrectly or overflow outside the screen depending on the TV screen mode setting. The OSD position switching makes it possible to display the OSD and on-screen messages normally.

At the factory, the player has been set to **"Normal"**.



Setting items

"↶" : Select to return to the previous screen.

"Normal" : Select to display the OSD and messages on the top of the TV screen. Usually select this setting.

"Cinema" : Select to display the OSD and messages on the lower part of the TV screen. Select this setting when the OSD or messages are deviated outside the TV screen.

Operation procedure

1. Set the mode switch of the joystick remote to the Purple position.
2. While the player is in stop mode, press  to display the **"MAIN"** menu of **"SET UP MENU"**.
3. Press  to open the setup screen.

4. In the setup menu, select "**OSD Position**" by tilting the joystick up or down and press .

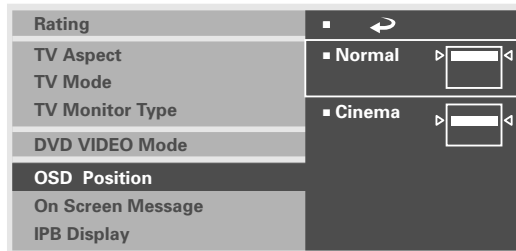

5. Select the OSD position by tilting the joystick up or down, then press  to enter the selection in memory.

"On Screen Message" Setting

This setting makes it possible to enable or display of on-screen messages which notifies the user of various information.

At the factory, the player has been set to "**On**" for displaying on-screen messages.



Setting items

"◀ ▶" : Select to return to the previous screen.

"**On**" : Select to display on-screen messages.

"**Off**" : Select to not to display on-screen messages.

Operation procedure

1. Set the mode switch of the joystick remote to the Purple position.
2. While the player is in stop mode, press  to display the "**MAIN**" menu of "**SET UP MENU**".
3. Press  to open the setup screen.
4. In the setup menu, select "**On Screen Message**" by tilting the joystick up or down and press .

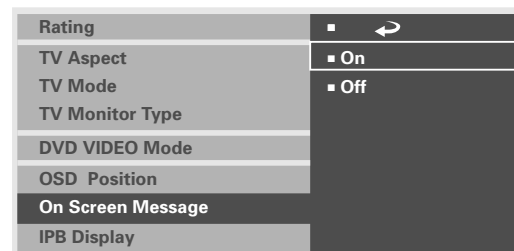

5. Select "**On**" or "**Off**" by tilting the joystick up or down, then press  to enter the selection in memory.

"IPB Display" Setting

With the MPEG2 which is one of the video display methods of DVD, each picture is divided into the following three picture types before being coded in digital signal.

I-picture (in-frame coding): This is the standard video and can constitute a picture by itself. As the highest picture quality can be obtained, the still image of I-picture is most suitable for use when adjusting the picture quality.

P-picture (forward prediction coding): Picture calculated based on past pictures (I-picture or P-picture).

B-picture (bidirectional prediction coding): Picture calculated by comparing the previous and next pictures (I-pictures or P-pictures). This picture type contains least amount of video information.



When **IPB Display** is set to "**On**", the I, P or B type of DVD still picture is displayed on the TV screen to help identify whether the picture is I-picture, P-picture or B-picture. This makes it possible to find the I-picture which is the standard video containing most amount of information.

At the factory, the player has been set to "**Off**" with which the IPB display is not shown.

Setting items

- "↩" : Select to return to the previous screen.
- "On" : Select to view the IPB display.
- "Off" : Select to not to view the IPB display.

Operation procedure

1. Set the mode switch of the joystick remote to the Purple position.
2. While the player is in stop mode, press  to display the "**MAIN**" menu of "**SET UP MENU**".
3. Press  to open the setup screen.
4. In the setup menu, select "**IPB Display**" by tilting the joystick up or down and press .

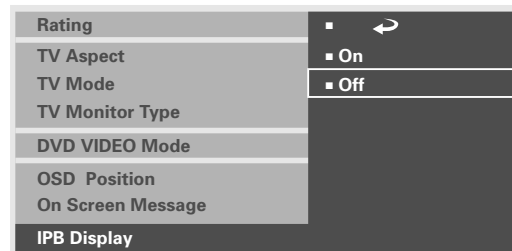

5. Select "**On**" or "**Off**" by tilting the joystick up or down, then press  to enter the selection in memory.

"SOUND" Setting

"Digital Audio PCM Down Conversion" Setting (DVD VIDEO disc only)

The player can output digital signal with maximum sampling rate of 96 kHz from the digital audio output connector. When a DVD disc recorded in high sampling rate PCM is played, this setting makes it possible to select whether the signal is converted into 48 kHz signal or 44.1 kHz/16-bit signal.

At the factory, the player has been set to "On" for AV amplifiers incompatible with high sampling rate digital signal connection. If the connected AV amplifier is compatible with 96 kHz digital input, change the setting to "Off".

Setting items

"↩" : Select to return to the previous screen.



"On" : Select to down-convert the signal to 44.1 kHz/16-bit PCM signal. Select this setting when the connected AV amplifier is incompatible with 96 kHz digital input.

- The analog output signals are also converted accordingly.

"Off" : Select to skip down conversion. Select this setting when the connected AV amplifier is compatible with 96 kHz digital input. However, if the disc inhibits the 96 kHz digital output, the signal is down-converted even when this setting is selected.

- With DVD AUDIO discs, the signal is always output after down sampling conversion.

Operation procedure

1. Set the mode switch of the joystick remote to the Purple position.
2. While the player is in stop mode, press  and tilt the joystick up or down to display the "SOUND" menu of "SET UP MENU".
3. Press  to open the setup screen.
4. In the setup menu, select "Digital Audio PCM Down Conversion" by tilting the joystick up or down and press .

Digital Audio	■ ↩
PCM Down Conversion	■ On
Dolby Digital	■ Off
DTS	
MPEG	
Speaker Setting (Custom)	
Speaker Setting (Quick)	
Audio During Search	
Dynamic Range Control	
Audio Filter	

5. Select "On" or "Off" by tilting the joystick up or down, then press  to enter the selection in memory.

"Digital Audio Dolby Digital" Setting

When a DVD recorded in Dolby Digital is played, this setting makes it possible to select the audio signal from the digital output connector of the player.

At the factory, the player has been set to "Bitstream" to enable digital connection to an AV amplifier with built-in Dolby Digital decoder. For the nonexistent decoders, set the "Digital Audio" setting to "PCM".



Setting items

"↩" : Select to return to the previous screen.

"Bitstream" : The signal is output as a bitstream. Select when connecting a component containing Dolby Digital decoder.

"PCM" : The signal is converted onto 48 kHz (2CH.) PCM signal before being output. Select when connecting a component without Dolby Digital decoder.

Operation procedure

1. Set the mode switch of the joystick remote to the Purple position.
2. While the player is in stop mode, press  and tilt the joystick up or down to display the "SOUND" menu of "SET UP MENU".
3. Press  to open the setup menu.
4. In the setup menu, select "Digital Audio Dolby Digital" by tilting the joystick up or down and press .

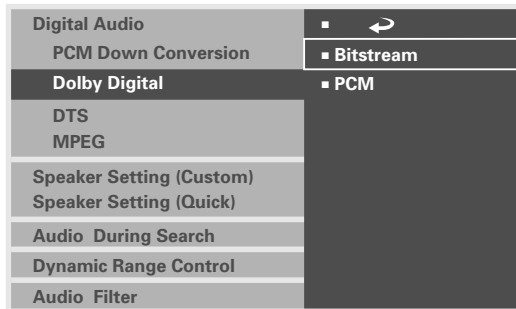

5. Select the audio output by tilting the joystick up or down, and press  to enter the selection in memory.

"Digital Audio DTS" Setting

When a DVD or DTS-CD recorded in DTS is played, this setting makes it possible to select the audio signal output from the digital output connector.

At the factory, the player has been set to "Bitstream" to enable digital connection to an AV amplifier with built-in DTS decoder. For the nonexistent decoders, set the "Digital Audio" setting to "PCM".



Setting items

"◀ ▶" : Select to return to the previous screen.

"Bitstream" : The signal is output as a bitstream. Select when connecting a component containing DTS decoder.

"PCM" : The signal is converted onto 48 kHz (2CH.) PCM signal before being output. Select when connecting a component without DTS decoder.

Operation procedure

1. Set the mode switch of the joystick remote to the Purple position.
2. While the player is in stop mode, press  and tilt the joystick up or down to display the "SOUND" menu of "SET UP MENU".
3. Press  to open the setup screen.
4. In the setup menu, select "Digital Audio DTS" by tilting the joystick up or down and press .

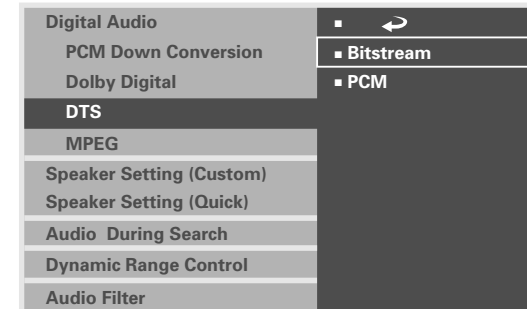

5. Select the audio output by tilting the joystick up or down, and press  to enter the selection in memory.

"Digital Audio MPEG" Setting

When a DVD recorded in MPEG Audio is played, this setting makes it possible to select the audio signal output from the digital output connector.

At the factory, the player has been set to "**Bitstream**" to enable digital connection to an AV amplifier with built-in MPEG decoder. For the nonexistent decoders, set the "**Digital Audio**" setting to "**PCM**".



Setting items

"↶": Select to return to the previous screen.

"**Bitstream**" : The signal is output as a bitstream. Select when connecting a component containing MPEG decoder.

"**PCM**" : The signal is converted onto 48 kHz (2CH) PCM signal before being output. Select when connecting a component without MPEG decoder.

Operation procedure

1. Set the mode switch of the joystick remote to the Purple position.
2. While the player is in stop mode, press  and tilt the joystick up or down to display the "**SOUND**" menu of "**SET UP MENU**".
3. Press  to open the setup screen.
4. In the setup menu, select "**Digital Audio MPEG**" by tilting the joystick up or down and press .

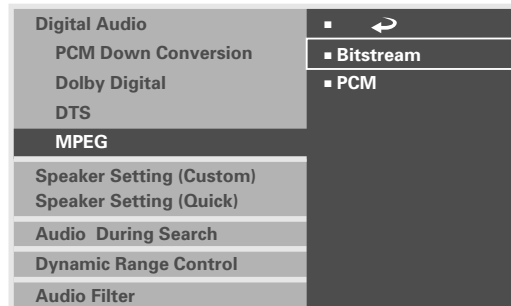

5. Select the audio output by tilting the joystick up or down, and press  to enter the selection in memory.

"Speaker Setting"

When an associated system component is connected to the **6CH. OUTPUT** jacks of the player, this setting is required on the player.





At the factory, the player has been set to the standard setting with which the speakers can reproduce the 6-channel signals as soon as the connections are made. This setting can be changed according to each listening environment. When you want to change this setting, be sure to perform it in the listening area in your own listening environment.

- For the "**Speaker Setting**" when an AV amplifier is connected digitally to the player, refer to the instruction manual of the AV amplifier.

"Speaker Setting (Quick)"

Three kinds of speakers can be set, including the "Center Speaker", "Surround Speakers" and "SubWoofers".

Operation procedure

1. Set the mode switch of the joystick remote to the Purple position.
2. While the player is in stop mode, press  and tilt the joystick up or down to display the "**SOUND**" menu of "**SET UP MENU**".
3. Press  to open the setup screen.
4. In the setup menu, select "**Speaker Setting (Quick)**" by tilting the joystick up or down and press .
5. Place the cursor on the speaker name you want to set to "Use" or "Do not use", then press the  button.

6. Each press of the  button turns on and off the corresponding speaker icon in the graphic room at the lower half of screen alternately. When the selected kind of speaker is to be used, the corresponding speaker icon should be displayed.

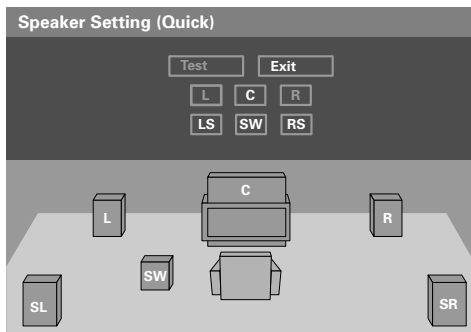

7. To set the use of other kinds of speakers, repeat step 5 for each of them.
8. After completing the setting, place the cursor on "Exit" and press .

"Speaker Setting (Custom)"

Setting items

Front speakers (L, R)

Size: "Large"

Level: "0 dB"

Center speaker (C)

Size: "Large"

Use of center speaker: Used

Level: "0 dB"

Delay time: "0 ms"

Surround speakers (SL, SR)

Size: "Large"

Use of surround speakers: Used

Level: "0 dB"





Delay time: "0 ms"

Subwoofer

Use of subwoofer: Used

Level: "0 dB"

Operation procedure

1. Set the mode switch of the joystick remote to the Purple position.
2. While the player is in stop mode, press  and tilt the joystick up or down to display the "SOUND" menu of "SET UP MENU".
3. Press  to open the setup screen.
4. In the setup menu, select "Speaker Setting (Custom)" by tilting the joystick up or down and press .
5. Set each speaker by tilting the joystick up/down and to the left/right. Select the item to be set and press .

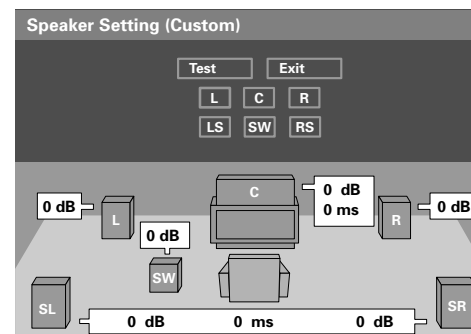

To set the front speakers: Select and adjust "L" or "R". The other, non-selected front speaker will automatically set to the same setting as the selected speaker.

To set the center speaker: Select "C".

To set the surround speakers: Select and adjust "SL" and "SR" separately.

To set the subwoofer: Select "SW".

To output the test tone: Select "Test"

To exit from the screen: Select "Exit"

6. Select the desired speaker setting by tilting the joystick up/down and to the left/right.

If "↔" is selected, the screen in step 5 appears again without entering the performed changes in the speaker setting in memory.

[Front Speakers setting]

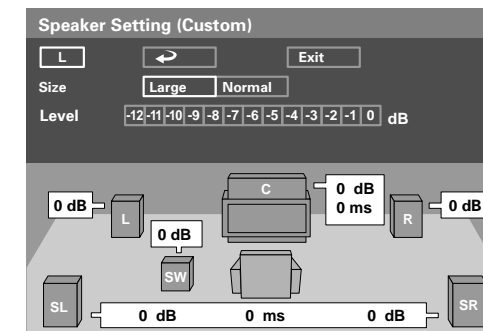

Size: Select "Normal" when the connected speaker is incapable of reproducing audio below 100 Hz.

Select "Large" when the connected speaker can reproduce audio below 100 Hz.

Level: Set the volume level.(0 ~ -12 dB)

After completing the speaker setting, select "Exit" to enter the setting and return to the screen in step 5.

Delay Time Setting

When playing a DVD recorded with Dolby Digital audio, the distances from the listening position to the center and surround speakers should ideally be identical to those of all other speakers except for the subwoofer. The delay time setting makes it possible to compensate for the difference in distances of actual speakers by delaying the audio output from the center speaker and surround speakers so that the sounds from all speakers reach the listening position at the same timing. (The delay time adjustment is available only with Dolby Digital.)

Before starting the speaker setting, see the following figure and measure distance A of the center speaker ($A = D_f - D_c$) and distance B for the surround speakers ($B = D_f - D_s$). The standard delay time settings can be identified based on these values and the following tables.

Ideal center speaker position

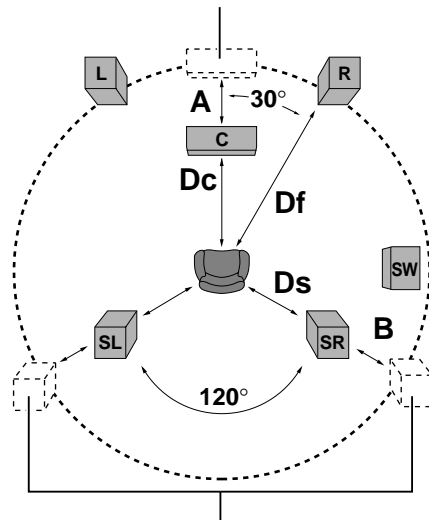

Ideal surround speaker positions

- All speakers should be laid out within a circle as shown in the figure.

Delay time of center speaker

Distance A ($A = D_f - D_c$)	Setting Value
Approx. 50 cm	"1.3" ms
Approx. 100 cm	"2.6" ms
Approx. 150 cm	"3.9" ms
Approx. 200 cm	"5.3" ms

- If distance D_f is equal to or shorter than D_c , set to "0".

Delay time of surround speakers

Distance B ($B = D_f - D_s$)	Setting Value
Approx. 200 cm	"5.3" ms
Approx. 400 cm	"10.6" ms
Approx. 600 cm	"15.9" ms

- If distance D_f is equal to or shorter than D_s , set to "0".

[Center speaker setting]

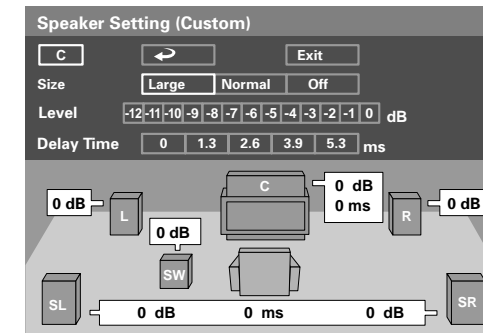

Size: Select "Normal" when the connected speaker is incapable of reproducing audio below 100 Hz. Select "Large" when the connected speaker can reproduce audio below 100 Hz.

Use of center speaker: Select "Off" if the center speaker is not used.

Level: Set the volume level. (0 ~ -12 dB)

Delay Time: Set the delay time. For the setting value, see "Delay Time Setting".

After completing the speaker setting, select "Exit" to enter the setting and return to the screen in step 5.

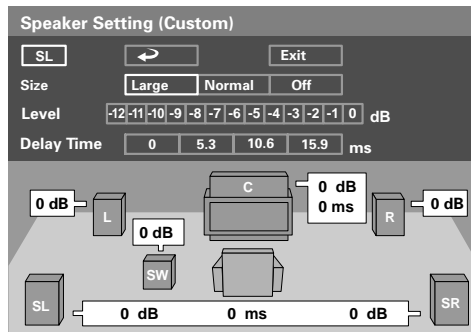
[Surround speakers setting]

Size: Select "**Normal**" when the connected speaker is incapable of reproducing audio below 100 Hz. Select "**Large**" when the connected speaker can reproduce audio below 100 Hz.

Use of surround speaker: Select "**Off**" if the surround speaker is not used.

Level: Set the volume level. (0 ~ -12 dB)

Delay Time: Set the delay time. For the setting value, see "**Delay Time Setting**".

After completing the speaker setting, select "**Exit**" to enter the setting and return to the screen in step 5.

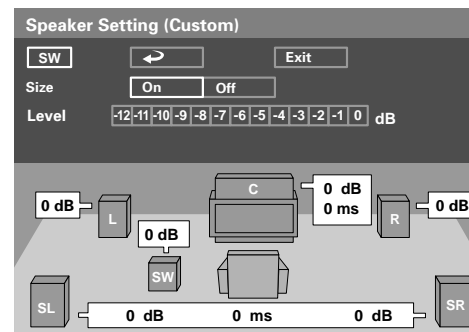
[Subwoofer setting]

Use of subwoofer: Select "**Off**" if the subwoofer is not used.

Level: Set the volume level.

After completing the speaker setting, select "**Exit**" to enter the setting and return to the screen in step 5.

7. After completing the speaker settings, select "**Test**" by tilting the joystick up/down or to the left/right and press **ENTER**. The cursor will automatically move across the speakers in sequence from "**L**" and the test tone is output from each speaker indicated by the cursor.

Press **ENTER** again to display the speaker setting screen for the speaker being indicated by the cursor.

- The cursor skips the subwoofer and the speakers set to "**Off**" and test tone is not output from them.
- After adjusting the level of each speaker channel by tilting the joystick to the left or right, press the **ENTER** button, then select "**Exit**" and press the **ENTER** button to restart the test tone output. Repeat the volume level adjustment until the volumes of all speakers are identical.
- When the joystick is tilted in any direction during the test tone output, the test tone output stops. (The same effect can also be obtained by pressing the **RETURN** button)

8. After completing the speaker setting, select "**Exit**" and press **ENTER** to enter the setting in memory.

- As the test tone is not output from the subwoofer, its volume level should be adjusted after listening to the actual sound.

"Audio During Search" Setting

During DVD or VCD search at the first speed step, this setting makes it possible to select whether the reproduced audio is output or not.

At the factory, the player has been set to "On" for outputting the reproduced audio during search.



Setting items

"↩" : Select to return to the previous screen.

"On" : Select to output audio during search.

"Off" : Select to mute audio during search.

Operation procedure

1. Set the mode switch of the joystick remote to the Purple position.
2. While the player is in stop mode, press  and tilt the joystick up or down to display the "SOUND" menu of "SET UP MENU".
3. Press  to open the setup screen.
4. In the setup menu, select "Audio During Search" by tilting the joystick up or down and press .

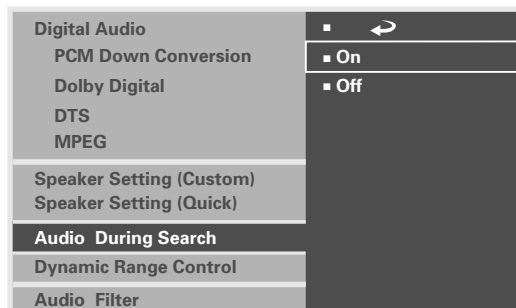

5. Select "On" or "Off" by tilting the joystick up or down, then press  to enter the selection in memory.

"Dynamic Range Control" Setting

When playing a DVD recorded with Dolby Digital Surround, set the dynamic range control according to the software being played. For instance, when the words are hard to be listened to due to effects sound in a movie, this setting makes it possible to adjust the volume level of only the low-level sound and can reduce repetition of complicated volume level adjustments.

At the factory, the player has been set to "Normal" with which the audio levels recorded in discs are reproduced as they are.

Setting items



"↩" : Select to return to the previous screen.

"Wide" : Select to reproduced the audio at the level recorded in the disc.

"Normal" : Select to reduce the difference between the maximum and minimum volume levels.

"Midnight" : Select to further reduce the difference between the maximum and minimum volume levels. This setting is suitable for low-level listening in late at night, etc.

Operation procedure

1. Set the mode switch of the joystick remote to the Purple position.
2. While the player is in stop mode, press  and tilt the joystick up or down to display the "SOUND" menu of "SET UP MENU".
3. Press  to open the setup screen.
4. In the setup menu, select "Dynamic Range Control" by tilting the joystick up or down and press .

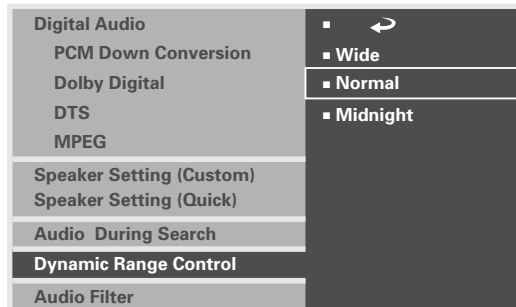

5. Select the level by tilting the joystick up or down, then press  to enter the selection in memory.

"Audio Filter" Setting

DVD AUDIO is recorded with a maximum sampling rate of 192 kHz and theoretically capable of reproducing up to 96 kHz. As a result, the speakers used may be damaged if they are not compatible with high frequencies. When an ordinary speaker system is connected, set the "Audio Filter" setting to "Filter 60 kHz" to protect the speakers. When the speaker in use are compatible with high frequencies, set this setting to "Filter 110 kHz". (For details, refer to the instruction manuals provided with your speakers.)

At the factory, the player has been set to "Filter 60 kHz" to protect the speakers from damage.



Setting items

"↩" : Select to return to the previous screen.

"Filter 60 kHz" : Select when the speakers in use are not suitable for reproduction of high frequencies.

"Filter 110 kHz" : Select when the speakers in use are suitable for reproduction of high frequencies.

Operation procedure

1. Set the mode switch of the joystick remote to the Purple position.
2. While the player is in stop mode, press  and tilt the joystick up or down to display the "SOUND" menu of "SET UP MENU".
3. Press  to open the setup screen.
4. In the setup menu, select "Audio Filter" by tilting the joystick up or down and press .

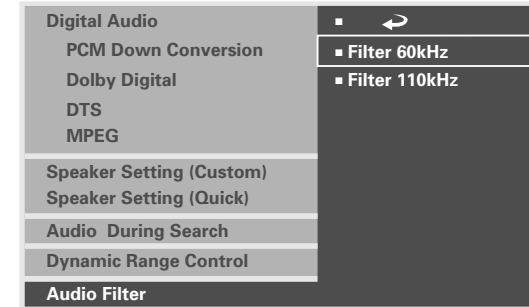

5. Select "Filter 60 kHz" or "Filter 110 kHz" by tilting the joystick up or down, then press  to enter the selection in memory.

"VISUAL" Setting

"Player Menu Language" Setting



This setting makes it possible to select the language used to display the menus of the player.

At the factory, the language used in displaying the menus of the player has been set to "**English**".

Setting items

- "↩" : Select to return to the previous screen.
- "**English**" : Select to display menus in English.
- "**French**" : Select to display menus in French.
- "**Spanish**" : Select to display menus in Spanish.
- "**German**" : Select to display menus in German.
- "**Italian**" : Select to display menus in Italian.
- "**Japanese**" : Select to display menus in Japanese.
- "**Chinese**" : Select to display menus in Chinese.
- "**Taiwanese**" : Select to display menus in traditional Chinese letters.

Operation procedure

1. Set the mode switch of the joystick remote to the Purple position.
2. While the player is in stop mode, press  and tilt the joystick up or down to display the "**VISUAL**" menu of "**SET UP MENU**".
3. Press  to open the setup screen.
4. In the setup menu, select "**Player Menu Language**" by tilting the joystick up or down and press .

For Europe and U.K.

Player Menu Language	↩
Disc Menu Language	English
Audio Language	French
Subtitle Language	Spanish
Still Mode	German
FL Mode	Italian
NTSC → PAL	Japanese
SCART Output Select	Chinese
	Taiwanese

Except for Europe and U.K.

Player Menu Language	↩
Disc Menu Language	English
Audio Language	French
Subtitle Language	Spanish
Still Mode	German
FL Mode	Italian
Black Level Setup	Japanese
	Chinese
	Taiwanese

5. Select the language by tilting the joystick up or down, then press  to enter the selection in memory.

"Disc Menu Language" Setting



This setting makes it possible to select the language used to display the menus recorded in discs. (If the selected language is not used in a specific disc, the language specified as the priority language for the disc will be used.)

At the factory, the language used in displaying the menus of the disc has been set to "**English**".

Setting items

- "↩" : Select to return to the previous screen.
- "**English**" : Select to display menus in English.
- "**French**" : Select to display menus in French.
- "**Spanish**" : Select to display menus in Spanish.
- "**German**" : Select to display menus in German.
- "**Italian**" : Select to display menus in Italian.
- "**Chinese**" : Select to display menus in Chinese.
- "**Other** ____" : Select to specify the language using a code No. listed in the "**Disc Language Code Table**". - 68
- The languages displayed with this setting item are variable depending on country and area.

Operation procedure

1. Set the mode switch of the joystick remote to the Purple position.
2. While the player is in stop mode, press  and tilt the joystick up or down to display the "**VISUAL**" menu of "**SET UP MENU**".
3. Press  to open the setup screen.

4. In the setup menu, select "**Disc Menu Language**" by tilting the joystick up or down and press . For Europe and U.K.

Player Menu Language	▀ ◀
Disc Menu Language	▀ English
Audio Language	▀ French
Subtitle Language	▀ Spanish
Still Mode	▀ German
FL Mode	▀ Italian
NTSC → PAL	▀ Other _ _ _ _
SCART Output Select	

Except for Europe and U.K.

Player Menu Language	▀ ◀
Disc Menu Language	▀ English
Audio Language	▀ French
Subtitle Language	▀ Spanish
Still Mode	▀ German
FL Mode	▀ Italian
Black Level Setup	▀ Other _ _ _ _

5. Select the language by tilting the joystick up or down, then press  to enter the selection in memory.
- When "**Other _ _ _ _**" is selected, set the mode switch of the joystick remote to the Orange position, input the desired code No. using the numeric keys and press the **ENTER** button.
 - If you make a mistake when pressing numeric keys, press the **C** button and restart the code No. input from the beginning.

"Audio Language" Setting

This setting makes it possible to select the language used to reproduce the audio recorded in the disc in the desired language. (If the selected language is not used in a specific disc, the language specified as the priority language for the disc will be used.)

At the factory, the audio language has been set to "**English**".

Setting items

"◀" : Select to return to the previous screen.

"**Original**" : Select to play audio in the language specified as the priority language by the disc.

"**English**" : Select to play menus in English.

"**French**" : Select to play menus in French.

"**Spanish**" : Select to play menus in Spanish.

"**German**" : Select to play menus in German.



"**Italian**" : Select to play menus in Italian.

"**Chinese**" : Select to play menus in Chinese.

"**Other _ _ _ _**" : Select to specify the language using a code No. listed in the "**Disc Language Code Table**". 

- The languages displayed with this setting item are variable depending on country and area.

Operation procedure

1. Set the mode switch of the joystick remote to the Purple position.
2. While the player is in stop mode, press  and tilt the joystick up or down to display the "**VISUAL**" menu of "**SET UP MENU**".
3. Press  to open the setup screen.

4. In the setup menu, select "**Audio Language**" by tilting the joystick up or down and press . For Europe and U.K.

Player Menu Language	▀ ◀
Disc Menu Language	▀ Original
Audio Language	▀ English
Subtitle Language	▀ French
Still Mode	▀ Spanish
FL Mode	▀ German
NTSC → PAL	▀ Italian
SCART Output Select	▀ Other _ _ _ _

Except for Europe and U.K.

Player Menu Language	▀ ◀
Disc Menu Language	▀ Original
Audio Language	▀ English
Subtitle Language	▀ French
Still Mode	▀ Spanish
FL Mode	▀ German
Black Level Setup	▀ Italian
	▀ Other _ _ _ _

5. Select the desired audio language by tilting the joystick up or down, then press  to enter the selection in memory.
- When "**Other _ _ _ _**" is selected, set the mode switch of the joystick remote to the Purple position, input the desired code No. using the numeric keys and press the **ENTER** button.
 - If you make a mistake when pressing numeric keys, press the **C** button and restart the code No. input from the beginning.

"Subtitle Language" Setting

This setting makes it possible to select the language used to display the subtitles recorded in discs. (When the disc does not contain the recording of the selected subtitle language, the default subtitle language defined for the disc will be used.)

At the factory, the language used in displaying the subtitles has been set to "**English**".

Setting items

"**↔**" : Select to return to the previous screen.

"**Auto**" : The subtitle language is selected automatically according to the "**Audio language**" setting.

Case in which subtitles are not displayed: When the voices are reproduced in the language selected with "**Audio language**", the subtitles are not displayed.

Case in which subtitles are displayed: When the voices cannot be reproduced in the language selected with "**Audio language**", subtitles are displayed in the language selected with "**Audio language**".

"**English**" : Select to display menus in English.

"**French**" : Select to display menus in French.

"**Spanish**" : Select to display menus in Spanish.

"**German**" : Select to display menus in German.

"**Italian**" : Select to display menus in Italian.

"**Chinese**" : Select to display menus in Chinese.



"**Other _ _ _ _**" : Select to specify the language using a code No. listed in the "**Disc Language Code Table**".

- The languages displayed with this setting item are variable depending on country and area.

Operation procedure

1. Set the mode switch of the joystick remote to the Purple position.
2. While the player is in stop mode, press  and tilt

the joystick up or down to display the "**VISUAL**" menu of "**SET UP MENU**".

3. Press  to open the setup screen.
4. In the setup menu, select "**Subtitle Language**" by tilting the joystick up or down and press .

For Europe and U.K.

Player Menu Language	▪ 
Disc Menu Language	▪ Auto
Audio Language	▪ English
Subtitle Language	▪ French
Still Mode	▪ Spanish
FL Mode	▪ German
NTSC → PAL	▪ Italian
SCART Output Select	▪ Other _ _ _ _

Except for Europe and U.K.

Player Menu Language	▪ 
Disc Menu Language	▪ Auto
Audio Language	▪ English
Subtitle Language	▪ French
Still Mode	▪ Spanish
FL Mode	▪ German
Black Level Setup	▪ Italian
	▪ Other _ _ _ _

5. Select the desired subtitle language by tilting the joystick up or down, then press  to enter the selection in memory.
 - When "**Other _ _ _ _**" is selected, set the mode switch of the joystick remote to the Orange position, input the desired code No. using the numeric keys and press the **ENTER** button.
 - If you make a mistake when pressing numeric keys, press the **C** button and restart the code No. input from the beginning.

"Still Mode" Setting

This setting makes it possible to reduce blur in still pictures automatically. In addition, it also allows you to select the frame still or field still picture.

At the factory, the player has been set to "**Auto**", with which frame still and field still pictures are switched automatically.

Setting items



"**↔**" : Select to return to the previous screen.

"**Auto**" : Frame still and field still pictures are switched automatically. Usually select this setting.

"**Frame**" : Select to display still pictures in a higher picture quality. (As the field and still pictures are displayed alternately, the picture may blur accordingly.)

"**Field**" : Select to display still pictures without blur. (As the video information is halved compared to the frame pictures, the picture quality deteriorates accordingly.)

Operation procedure

1. Set the mode switch of the joystick remote to the Purple position.
 2. While the player is in stop mode, press  and tilt the joystick up or down to display the "VISUAL" menu of "SET UP MENU".
 3. Press  to open the setup screen.
 4. In the setup menu, select "Still Mode" by tilting the joystick up or down and press .
- For Europe and U.K.

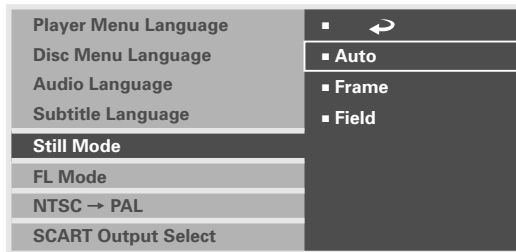

Except for Europe and U.K.



5. Select the desired still mode by tilting the joystick up or down, then press  to enter the selection in memory.

"FL Mode" Setting

This setting makes it possible to select the brightness of the player's display panel.

At the factory, the player has been set to "Brightness", with which the display is permanently displayed in high brightness.

Setting items



"↔" : Select to return to the previous screen.

"**Brightness**" : The display is permanently in high brightness.

"**Dimmer**" : The display is permanently displayed in low brightness.

"**Auto Off**" : The display is automatically turned off with DVD or VCD. (The display is shown when DVD AUDIO without video is played.) At this time, the "Disc 1 to 5" indicators light in low brightness and other indicators are off.

Operation procedure

1. Set the mode switch of the joystick remote to the Purple position.
2. While the player is in stop mode, press  and tilt the joystick up or down to display the "VISUAL" menu of "SET UP MENU".
3. Press  to open the setup screen.
4. In the setup menu, select "FL Mode" by tilting the joystick up or down and press .

For Europe and U.K.

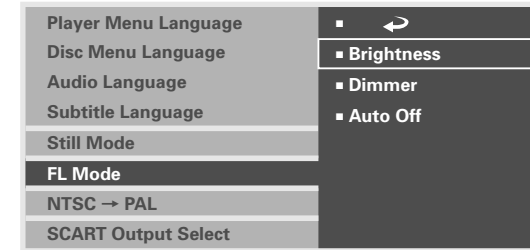

Except for Europe and U.K.

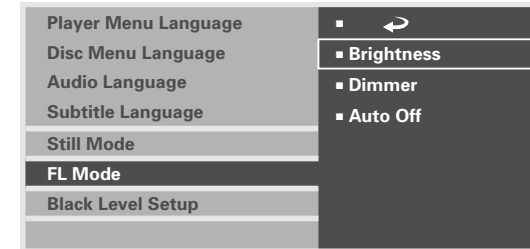

5. Select the FL mode by tilting the joystick up or down, then press  to enter the selection in memory.



"NTSC → PAL" Setting (For Europe and U.K.)

This setting makes it possible to play an NTSC-format disc by converting signal into PAL format. Select "**On**" when it is required to convert NTSC-format discs into PAL signals.

Setting items

- "↩" : Select to return to the previous screen.
- "**On**" : Select to enable conversion from NTSC to PAL.
- "**Off**" : Select to disable conversion from NTSC to PAL.

Operation procedure

1. Set the mode switch of the joystick remote to the Purple position.
2. While the player is in stop mode, press  and tilt the joystick up or down to display the "**VISUAL**" menu of "**SET UP MENU**".
3. Press  to open the setup screen.
4. In the setup menu, select "**NTSC → PAL**" by tilting the joystick up or down and press .

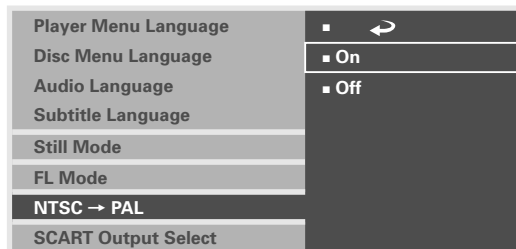

5. Select "**On**" or "**Off**" by tilting the joystick up or down, then press  to enter the selection in memory.

"SCART Output Select" Setting (For Europe and U.K.)

This setting makes it possible to select the output signals from the **TV SCART** connector of the player. (The **VCR SCART** connector always outputs composite video signals so its output signals cannot be selected.)



When the "**RGB**" output signals are selected with this setting, the **COMPONENT VIDEO OUTPUT** jacks of the player do not output any video signal.

At the factory, the **TV SCART** connector output signals of the player has been set to "**Composite**".

Setting items

- "↩" : Select to return to the previous screen.
- "**Composite**" : Select to output composite video signal.
- "**S Video**" : Select to output S Video signals.
- "**RGB**" : Select to output RGB signals.

Operation procedure

1. Set the mode switch of the joystick remote to the Purple position.
2. While the player is in stop mode, press  and tilt the joystick up or down to display the "VISUAL" menu of "SET UP MENU".
3. Press  to open the setup screen.
4. In the setup menu, select "SCART Output Select" by tilting the joystick up or down and press .

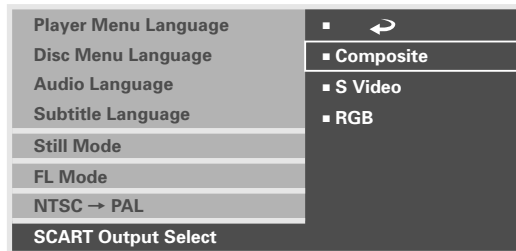

5. Select the desired output signals by tilting the joystick up or down, then press  to enter the selection in memory.



"Black Level Setup" Setting (Except for Europe and U.K.)

This function makes the adjustment of the black level. Set to your preference and monitor's ability.

Setting items

- "↔" : Select to return to the previous screen.
- "7.5 IRE" : Standard black level.
- "0 IRE" : Expanded black level.
- As for this function, only interlace output is effective.

Operation procedure

1. Set the mode switch of the joystick remote to the Purple position.
2. While the player is in stop mode, press  and tilt the joystick up or down to display the "VISUAL" menu of "SET UP MENU".
3. Press  to open the setup screen.
4. In the setup menu, select "Black Level Setup" by tilting the joystick up or down and press .

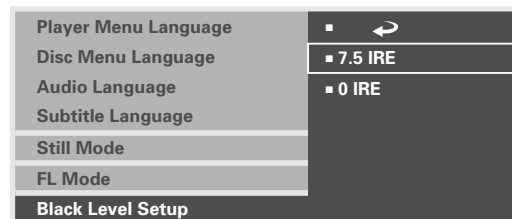

5. In the setup menu, select "7.5 IRE" or "0 IRE" by tilting the joystick up or down and press .

Disc Language Code Table

Cord No. : Language
6565 : Afar
6566 : Abkhazian
6570 : Afrikaans
6577 : Amharic
6582 : Arabic
6583 : Assamese
6588 : Aymara
6590 : Azerbaijani
6665 : Bashkir
6669 : Byelorussian
6671 : Bulgarian
6672 : Bihari
6678 : Bengali; Bangla
6679 : Tibetan
6682 : Breton
6765 : Catalan
6779 : Corsican
6783 : Czech
6789 : Welsh
6865 : Danish
6869 : German
6890 : Bhutani
6976 : Greek
6978 : English
6979 : Esperanto
6983 : Spanish
6984 : Estonian
6985 : Basque
7065 : Persian
7073 : Finnish
7074 : Fiji
7079 : Faroese
7082 : French

Cord No. : Language
7089 : Frisian
7165 : Irish
7168 : Scots Gaelic
7176 : Galician
7178 : Guarani
7185 : Gujarati
7265 : Hausa
7273 : Hindi
7282 : Croatian
7285 : Hungarian
7289 : Armenian
7365 : Interlingua
7378 : Indonesian
7383 : Icelandic
7384 : Italian
7387 : Hebrew
7465 : Japanese
7473 : Yiddish
7487 : Javanese
7565 : Geogian
7575 : Kazakh
7576 : Greenlandic
7577 : Cambodian
7578 : Kannada
7579 : Korean
7583 : Kashmiri
7585 : Kurdish
7589 : Kirghiz
7665 : Latin
7678 : Lingala
7679 : Laothian
7684 : Lithuanian
7686 : Latvian; Lettish

Cord No. : Language
7771 : Malagasy
7773 : Maori
7775 : Macedonian
7776 : Malayalam
7778 : Mongolian
7779 : Moldavian
7782 : Marathi
7783 : Malay
7784 : Maltese
7789 : Burmese
7865 : Nauru
7869 : Nepali
7876 : Dutch
7879 : Nowegian
7982 : Oriya
8065 : Punjabi
8076 : Polish
8083 : Pashto; Pushto
8084 : Portuguese
8185 : Quechua
8277 : Rhaeto-Romance
8279 : Romanian
8285 : Russian
8365 : Sanskrit
8368 : Sindhi
8372 : Serbo-Croatian
8373 : Singhalese
8375 : Slovak
8376 : Slovenian
8377 : Samoan
8378 : Shona
8379 : Somali
8381 : Albanian

Cord No. : Language
8382 : Serbian
8385 : Sundanese
8386 : Swedish
8387 : Swahili
8465 : Tamil
8469 : Telugu
8471 : Tajik
8472 : Thai
8473 : Tigrinya
8475 : Turkmen
8476 : Tagalog
8479 : Tonga
8482 : Turkish
8484 : Tatar
8487 : Twi
8575 : Ukrainian
8582 : Urdu
8590 : Uzbek
8673 : Vietnamese
8679 : Volapük
8779 : Wolof
8872 : Xhosa
8979 : Yoruda
9072 : Chinese
9085 : Zulu

Chapter 7: Other Information

To Be Noted →  70

Symptoms and Treatment →  72

Glossary →  74

Specifications →  76

To Be Noted

Maintenance of the unit

When the front panel or case becomes dirty, wipe with a soft, dry cloth. Do not use thinner, benzine, alcohol, etc. for these agents may cause discoloration.

In regard to contact cleaner

Do not use contact cleaners because it could cause a malfunction. Be specially careful not to use contact cleaners containing oil, for they may deform the plastic component.

Never play a cracked or warped disc

During playback, the disc rotates at high speed in the player. Therefore, to avoid danger, never use a cracked or deformed disc or a disc repaired with tape or adhesive agent. Please do not use discs which are not round because they may cause malfunction.

Disc accessories

The disc accessories (stabilizer, protection sheet, protection ring, etc.) which are marketed for improving the sound quality or protecting discs as well as the disc cleaner should not be used with this system because they may cause malfunction. Disc handling precautions

Handling : Hold the disc so that you do not touch the playing surface.

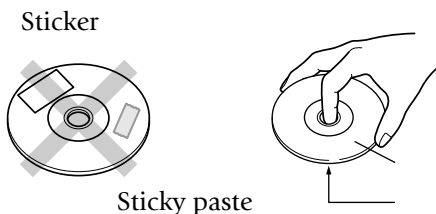

Do not attach paper or tape to either the playing side or the label side of the discs.

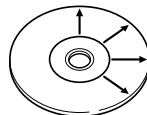

Cleaning : If there fingerprint marks or foreign matter found on the disc, lightly wipe the disc with a soft cotton cloth (or similar) from the center of the disc outwards in a radial manner.



Storage : When a disc is not to be played for a long period of time, remove it from the player and store it in its case.

Malfunction of Microcomputer

In case the microcomputer malfunctions, making operations impossible or showing wrong messages on the display even if you connected everything properly. When the microcomputer malfunctions, perform the following procedure to reset the microcomputer and return it to the normal condition.

1. While holding  on the player main unit, press  .
2. The display on the main unit shows blinking "INIT"(initializing), then shows "INIT OK!" (Initialization OK) to indicate that the microcomputer is reset.
3. Press  on the main unit to turn it off, then press it again to turn it on.
 - The resetting clears the setups stored in the microcomputer and returns it to the factory-set initial condition. After resetting, you should perform the various setups of the player again from the beginning.

Transport or moving precautions

When transporting or moving the player, first remove the disc and observe the following procedure.

1. Turn the player power on.
2. If any disc is left in the player, eject all of the discs left in it.
3. Wait for a few seconds, until the display shows "NO DISC".
4. Turn the player power off by pressing  .

Caution on condensation

Condensation (of dew) may occur inside the unit when there is a great difference in temperature between this unit and the outside.

This unit may not function properly if condensation occurs. In this case, leave the unit for a few hours and restart the operation after the condensation has dried up.

Be specially cautious against condensation in the following circumstances:

When this unit is carried from one place to another across a large difference in temperature, when the humidity in the room where this unit is installed increases, etc.

Apparatus Claims of U.S. Patent Nos. 4,631,603, 4,577,216, 4,819,098, and 4,907,093 licensed for limited viewing uses only.

This product incorporates copyright protection technology that is protected by method claims of certain U.S. patents and other intellectual property rights owned by Macrovision Corporation and other rights owners. Use of this copyright protection technology must be authorized by Macrovision Corporation, and is intended for home and other limited viewing uses only unless otherwise authorized by Macrovision Corporation. Reverse engineering or disassembly is prohibited.

Consumers should note that not all high definition television sets are fully compatible with this product and may cause artifacts to be displayed in the picture. In case of 525 progressive scan picture problems, it is recommended that the user switch the connection to the "STANDARD DEFINITION" output. If there are questions regarding our TV set compatibility with this model 525p DVD player, please contact our customer service center.



Manufactured under license from Dolby Laboratories. "DOLBY" and the double-D symbol are trademarks of Dolby Laboratories.



Manufactured under license from Digital Theater Systems, Inc. US Pat. No. 5,451,942, 5,956,674, 5,974,380, 5,978,762 and other worldwide patents issued and pending. "DTS" and "DTS Digital Surround" are registered trademarks of Digital Theater Systems, Inc. © 1996, 2000 Digital Theater Systems, Inc. All rights reserved.



As an ENERGY STAR® Partner, Kenwood Corporation has determined that this product meets the ENERGY STAR® guidelines for energy efficiency. This product can save energy. Saving energy reduces air pollution and lowers utility bills.

CAUTION (For the U.S.A.)

Use of controls or adjustments or performance of procedures other than those specified herein may result in hazardous radiation exposure.

In compliance with Federal Regulations, the following are reproductions of labels on, or inside the product relating to laser product safety.

**KENWOOD CORPORATION
2967-3, ISHIKAWA-CHO,
HACHIOJI-SHI,
TOKYO, JAPAN**

**KENWOOD CORP. CERTIFIES THIS
EQUIPMENT CONFORMS TO DHHS
REGULATIONS NO. 21 CFR
1040.10, CHAPTER 1, SUBCHAPTER J.**

Location: Back Panel

FCC WARNING (For the U.S.A.)

This equipment may generate or use radio frequency energy. Changes or modifications to this equipment may cause harmful interference unless the modifications are expressly approved in the instruction manual. The user could lose the authority to operate this equipment if an unauthorized change or modification is made.

NOTE :

This equipment has been tested and found to comply with the limits for a Class B digital device, pursuant to Part 15 of the FCC Rules. These limits are designed to provide reasonable protection against harmful interference in a residential installation. This equipment may cause harmful interference to radio communications, if it is not installed and used in accordance with the instructions. However, there is no guarantee that interference will not occur in a particular installation. If this equipment does cause harmful interference to radio or television reception, which can be determined by turning the equipment off and on, the user is encouraged to try to correct the interference by one or more of the following measures:

- Reorient or relocate the receiving antenna.
- Increase the separation between the equipment and receiver.
- Connect the equipment into an outlet on a circuit different from that to which the receiver is connected.
- Consult the dealer or an experienced radio / TV technician for help.

Symptoms and Treatment

Playback starts but the video is not output.

- The Pure Audio function is set to on. → 27
- The input selection of the TV and/or AV amplifier is incorrect or these devices are not turned on.
- Connection cords are connected improperly. → 10 → 12

Playback starts but the audio is not output.

- The "Speaker Setting" is incorrect. → 56
- The input selection of the TV and/or AV amplifier is incorrect or these devices are not turned on.
- The volume of the TV and/or AV amplifier is not adjusted properly.
- Audio output cords are connected improperly. → 10 → 12

The picture is disturbed during forward search or reverse search.

- The picture disturbance during forward search or reverse is normal. This is not a malfunction.

The picture is not neat or the video or audio quality is poor.

- Connection cords are connected improperly. → 10 → 12
- A device generating noise is installed near the signal path.
- The disc is dirty or damaged. To prevent this, remove dirt and handle discs carefully so as not to damage them. → 70
- There may be condensation of dew on the optical lenses. In this case, leave the player with power ON for a few hours to dry up the condensation, then retry operation. → 70

It takes long time before playback starts.

- The disc type should be detected and motor rotation stabilized before starting playback. This is normal and not a malfunction.

A warning is displayed on the TV screen and playback is not possible.

- The reproduced video may be disturbed or audio may be skipped when the disc surface is stained with fingerprints or dirt. Clean the disc surface by wiping it in the radial directions using a soft cloth. → 70
- If the disc is placed obliquely or on another disc, place the disc correctly. → 21
- Playback may be unavailable due to viewing restriction or region code problem. → 6 → 47

The top and bottom edges of the picture are cut off.

- The video format of the played disc does not match that of the connected TV. → 7

VCD cannot be played with menu playback.

- Menu playback is not available when P.B.C. is Off or the sequential play mode of the player is set to "SEQ.2". → 25
- Menu playback is possible only with P.B.C.-compatible VCDs. → 24

DVD VIDEO cannot be played.

- DVD VIDEO cannot be played when the sequential mode of the player is set to "SEQ.2". Switch it to "SEQ.1". → 25

Subtitles are not displayed.

- Subtitles are not displayed when the played DVD does not contain the recording of subtitles.
- The subtitle language is set to "Off". → 36 → 64

Audio (or subtitle) language cannot be changed.

- The language cannot be switched when the played DVD does not contain the recording of multiple audio (or subtitle) languages. → 36 → 63 → 64

Viewing angle cannot be changed.

- The viewing angle cannot be switched when the played DVD does not contain the recording of multiple angles. The viewing angle can neither be switched in part where no angle is recorded. → 37

The viewing restriction (Rating) cannot be changed.

- If you have lost the password, initialize the default setting by the user to the factory setting as described below.
While holding the ■ button on the main unit, press the **POWER** button. When the display shows "INIT OK!", switch the power on again. → 70

The selected audio or subtitle languages is not played.

- If the played DVD does not contain the default language set by the user, the priority language specified for the disc will be selected. → 63 → 64



The TV screen does not show any message when a button is pressed.

- If "On Screen Message" is set to "Off", switch it "On". → 52

The messages in the menus are not displayed in the selected language.

- If the played DVD does not contain the recording of the default language set by the user, the priority language specified for the disc will be selected. → 63

Remote control with the joystick remote is impossible.

- The batteries are exhausted.
- The controller position is too apart from the remote sensor, the control angle is deviated or there is an obstacle between the remote and remote sensor. → 
- The mode switch is not set to the proper position.
→  to → 

An inhibition icon is displayed and no operation is accepted.

- The operations of certain DVDs and VCDs are restricted by the intention of the software producers. Such discs should be operated in accordance with the software. Operations may also be restricted depending on the player status.

DVD playback cannot be stopped by pressing the STOP button.

- With certain DVDs, the inhibition icon is displayed and playback cannot be stopped even when the ■ button is pressed. In this case, press the **DISC SKIP** button to select another disc then press the ■ button to stop playback.
If there is only one disc in the tray, open the tray, place another disc, close the tray, press the **DISC SKIP** button to select the second disc, then press the ■ button to stop playback.

Glossary

DVD (Digital Versatile Disc): DVD VIDEO is a disc featuring high video/audio quality, made possible by large recording capacity of video and audio signals of movie software, etc. and by digital signal processing. DVD AUDIO has been desired to provide even higher audio quality than DVD VIDEO by using high-bit, high sampling rate processing.

VIDEO CD (VCD): This is a CD containing moving picture. By compressing video data to about 1/120 and audio data to about 1/6, a 12 cm disc with the same size as ordinary music CD can store moving pictures and audio for up to about 74 minutes.

The VCD includes the P.B.C.-incompatible discs with only the playback capability (Version 1.1) and P.B.C.-compatible discs with the menu playback and special playback capabilities (Version 2.0)

MPEG (Moving Picture Expert Group) (DVD, VCD): A digital video and audio compression and decompression system which is standardized as an international standard.

Decoder: A device for restoring standard audio signal from audio data recorded based on coding into DVD data, etc. This processing is referred to as decoding.

Downmixing: Conversion of multichannel audio signals of DVD or DTS-CD into 2-channel stereo signals.

Sampling rate: Sampling refers to converting an analog signal into digital signal by slicing the analog signal into fine parts at a certain time interval and digitizing every sliced part. The sampling rate is the count of slicing per second. The original sound can be reproduced more faithfully when the sampling rate is higher.

Quantization bit: The quantization bit count refers to the number used in digitizing the sliced parts obtained by slicing the analog signal as described above. The quantization bit count is the number of bits used in digitization per second. The original sound can be reproduced more faithfully when the quantization bit count is larger.

Linear PCM (Pulse Code Modulation): Audio signal format without using compression. In the DVD which has a very large disc capacity, the linear PCM signal using high sampling rate can be recorded.

Packed PCM : The packed PCM(P.PCM) signal is obtained by compressing the linear PCM signal featuring large data amount and high sampling rate. With this compression, the signal before compression can be restored perfectly.

Bitstream (DVD): This is the generic name given for the flow of data based on a standard such as Dolby Digital, DTS, MPEG, etc.

Dolby Digital: A digital audio compression technology developed by Dolby Laboratories, Inc. It is compatible with 6-channel surround audio as well as 2-channel stereo, and capable of recording a large amount of audio data efficiently in a disc.

DTS : Digital surround system developed by Digital Theater Systems, Inc.

Title/Title No. (DVD VIDEO): The title is the largest unit of video or audio recorded in DVD VIDEO. Usually, a title corresponding to a movie product with video software or an album (or a piece of music) with music software. The numbers assigned to the titles are referred to as title numbers.

Chapter/Chapter No. (DVD VIDEO): The chapter is a partition of video or audio that is smaller than the title. A title is composed of multiple chapters. The numbers assigned to the chapters are referred to as chapter numbers.

Group/Group No. (DVD AUDIO): The group is the largest unit of the contents in DVD AUDIO. Usually, a group corresponds to an album. The numbers assigned to the groups are referred to as group numbers.

Track/Track No. (DVD AUDIO, VCD, CD): The track is a partition of audio (such as a piece of music or music chapter) in a disc. These partitions are numbered and the numbers are referred to as track numbers. While a track usually corresponds to a piece of music with DVD AUDIO or ordinary music CD, the partitions of contents and track numbers are not always corresponding with VCD. As a result, while all of the playback operations including track skipping and programming of ordinary music CD are based on the track number information, such operations may sometimes be unavailable with VCD.

AVTT (Audio Video Title): Part of DVD AUDIO that contains moving pictures. The audio language, subtitle language and viewing angles in this part can be switched by the user.

AOTT (Audio Only Title): Part of DVD AUDIO that contains audio and still pictures. The audio language and still pictures in this part can be switched by the user.

Subtitle language (DVD): Some DVDs contain the recording of multiple subtitle languages. This player allows the user to select desired one of the recorded subtitle languages during playback of such a DVD.

Angle (DVD): Some DVDs contain the recording of multiple viewing angles. This player allows the user to select desired one of the recorded angles during playback of such a DVD.

Audio language (DVD): Some DVDs contain the recording of multiple audio languages. This player allows the user to select desired one of the recorded audio languages during playback of such a DVD.

Aspect ratio: The ratio between the horizontal and vertical sizes of picture displayed on a TV screen. The aspect ratio of ordinary TV is 4:3, and that of widescreen TV is 16:9.

Pan & scan (DVD): Method of displaying a horizontally-long picture recorded in 16:9 aspect ratio on a 4:3 TV screen by trimming part of picture.

In general, the trimming positions for pan & scan are determined uniformly by the reproducing device. However, the pan & scan of DVD allows the software producer to specify the trimming positions to be used in playback.

Letterbox (DVD): Method of displaying a horizontally-long picture recorded in 16:9 aspect ratio on a 4:3 TV screen by attaching bands at the top and bottom of the screen and displaying the horizontally-long picture at the center of screen.

Frame (DVD, VCD): Each frame of a moving picture, that is displayed 30 times a second with NTSC and 25 times a second with PAL. These TV formats reproduce moving pictures by displaying still pictures sequentially.

Field (DVD, VCD): Part of a frame obtained by dividing the video data of each frame by two. Each frame of ordinary TV is constituted by displaying the fields alternately.

Frame still/Field still (DVD, VCD): Types of still pictures obtained by temporarily stopping a moving picture. The frame still picture may produce blur in the picture because it displays two specific fields alternately, but the picture quality is higher. The field still picture has lower picture quality because it uses half the picture information of frame still, but is not accompanied with picture blur.

IPB display (DVD): With the MPEG2 which is one of the video display methods of DVD, each picture is divided into the following three picture types before being coded in digital signal.

I-picture (Intra coded): This is the standard video and can constitute a picture by itself. As the highest picture quality can be obtained, the still image of I-picture is most suitable for use when adjusting the picture quality.

P-picture (Predictive coded): Picture calculated based on past pictures (I-picture or P-picture).

B-picture (Bidirectionally predictive coded): Picture calculated by comparing the previous and next pictures (I-pictures or P-pictures). This picture type contains least amount of video information.

P.B.C. (PlayBack Control) (VCD): VIDEO CDs carrying messages such as "Playback Control Capable" can be played interactively by selecting the desired play position or information in hierarchical structures while watching the menus displayed on the TV screen.

OSD (On-Screen Display): OSD is a method of interactive operations using the menus and icons displayed on the TV screen.

On-Screen Message: Message displayed on the TV screen when an operation is performed.

Downconversion: Conversion of PCM signal with high sampling rate such as 96 kHz and 192 kHz into a signal with a sampling rate of 48 kHz or 44.1 kHz.

Dynamic range: Difference between the minimum reproducible audio signal and maximum reproducible audio signal.

Specifications

Format section

Format DVD audio ver. 1.2 / DVD video ver.1.1
Laser Semiconductor laser

Audio section

Frequency response
Sampling frequency: 44.1kHz (CD only) 4 Hz~20 kHz
Sampling frequency: 48 kHz 4 Hz~22 kHz
Sampling frequency: 96 kHz 4 Hz~44 kHz
Sampling frequency: 192 kHz (DVD AUDIO only)
..... 4 Hz~88 kHz
Signal to noise ratio More than 120 dB
Dynamic range More than 100 dB
Total harmonic distortion Less than 0.003 % (1kHz)
Channel separation More than 95 dB (1kHz)
Analog output level/impedance
MIX LINE OUTPUT 2 V/ 510 Ω
6 CH. OUTPUT 2 V / 510 Ω
Digital output level/impedance
COAXIAL 0.5 Vp-p/ 75 Ω
OPTICAL (Wave length 660 nm) -21 dBm ~ -15 dBm
Headphone output 30 mW/ 32 Ω load (Phones level MAX)

Video Section

Video output format PAL/PAL60*/NTSC*
(*NTSC disc play only)
Composite video output level 1 Vp-p (75 Ω)
S-video output level
(Y-signal) 1 Vp-p (75 Ω)
(C-signal) 0.286 Vp-p (75 Ω)
Component video output level
[For Europe and U.K.]
(Y-signal) 1 Vp-p (75 Ω)
(Cb-signal) 0.7 Vp-p (75 Ω)
(Cr-signal) 0.7 Vp-p (75 Ω)
Component video output level
(Interlace/"Black Level Setup"=7.5 IRE)
[Except for Europe and U.K.]
(Y-signal) 1 Vp-p (75 Ω)
(Cb-signal) 0.68 Vp-p (75 Ω)
(Cr-signal) 0.68 Vp-p (75 Ω)
RGB output level (SCART) 0.7 Vp-p (75 Ω)
Video signal to noise ratio 65 dB
Horizontal resolution 500 lines

Laser Section (DVD)

Wavelength 643 ~ 683 nm
Laser power class class 2 (IEC)

General Section

Power consumption 40 W
Dimensions W : 440 mm (17-5/16")
H : 127 mm (5")
D : 410 mm (16-1/8")
Weight (net) 6.8 kg (15 lb)

KENWOOD follows a policy of continuous advancements in development. For this reason specifications may be changed without notice.

Sufficient performance may not be exhibited at extremely cold locations (Where water freezes).

KENWOOD

For your records

Record the serial number, found on the back of the unit, in the spaces designated on the warranty card, and in the space provided below. Refer to the model and serial numbers whenever you call upon your dealer for information or service on this product.

Model _____ Serial Number _____

Free Manuals Download Website

<http://myh66.com>

<http://usermanuals.us>

<http://www.somanuals.com>

<http://www.4manuals.cc>

<http://www.manual-lib.com>

<http://www.404manual.com>

<http://www.luxmanual.com>

<http://aubethermostatmanual.com>

Golf course search by state

<http://golfingnear.com>

Email search by domain

<http://emailbydomain.com>

Auto manuals search

<http://auto.somanuals.com>

TV manuals search

<http://tv.somanuals.com>