

KENWOOD

DVD/VCD/CD PLAYER

DV-603

DVF-3060

DVF-3060K

INSTRUCTION MANUAL

KENWOOD CORPORATION

This instruction manual is for some models. Model availability and features (functions) may differ depending on the country and sales area.



Before applying power

 **Caution : Read this page carefully to ensure safe operation.**

Units are designed for operation as follows.

U.S.A. and Canada AC 120V only

Other countries AC 110 – 240 V

For the United Kingdom

Factory fitted moulded mains plug

1. The mains plug contains a fuse. For replacement, use only a 13-Amp ASTA-approved (BS1362) fuse.
2. The fuse cover must be refitted when replacing the fuse in the moulded plug.
3. Do not cut off the mains plug from this equipment. If the plug fitted is not suitable for the power points in your home or the cable is too short to reach a power point, then obtain an appropriate safety approved extension lead or adapter, or consult your dealer.

If nonetheless the mains plug is cut off, remove the fuse and dispose of the plug immediately, to avoid a possible shock hazard by inadvertent connection to the mains supply.

IMPORTANT :

The wires in the mains lead are coloured in accordance with the following code:

Blue : Neutral





Brown : Live

Do not connect those leads to the earth terminal of a three-pin plug.

Safety precautions

 **Caution : Read this page carefully to ensure safe operation.**

WARNING : TO PREVENT FIRE OR ELECTRIC SHOCK, DO NOT EXPOSE THIS APPLIANCE TO RAIN OR MOISTURE.

	CAUTION <small>RISK OF ELECTRIC SHOCK DO NOT OPEN</small>		CAUTION: TO REDUCE THE RISK OF ELECTRIC SHOCK, DO NOT REMOVE COVER (OR BACK). NO USER-SERVICEABLE PARTS INSIDE. REFER SERVICING TO QUALIFIED SERVICE PERSONNEL.
	THE LIGHTNING FLASH WITH ARROWHEAD SYMBOL, WITHIN AN EQUILATERAL TRIANGLE, IS INTENDED TO ALERT THE USER TO THE PRESENCE OF UNINSULATED "DANGEROUS VOLTAGE" WITHIN THE PRODUCT'S ENCLOSURE THAT MAY BE OF SUFFICIENT MAGNITUDE TO CONSTITUTE A RISK OF ELECTRIC SHOCK TO PERSONS.		
	THE EXCLAMATION POINT WITHIN AN EQUILATERAL TRIANGLE IS INTENDED TO ALERT THE USER TO THE PRESENCE OF IMPORTANT OPERATING AND MAINTENANCE (SERVICING) INSTRUCTIONS IN THE LITERATURE ACCOMPANYING THE APPLIANCE.		

The marking of products using lasers (For countries other than U.S.A., U.S.-Military and Canada)



The marking this product has been classified as Class 1. It means that there is no danger of hazardous radiation outside the product.

Location: Back panel

Unpacking

Unpack the unit carefully and make sure that all the accessories are present.

If any accessories are missing, or if the unit is damaged or fails to operate, notify your dealer immediately. If the unit was shipped to you directly, notify your shipper immediately. Kenwood recommends that you retain the original carton and packing materials in case you need to move or ship the unit in the future.

Keep this manual handy for future reference.

Accessories

Please confirm that the following accessories are present.

Audio video cord (Red, White, Yellow) ... (1)

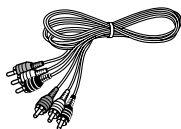

Remote control unit ... (1)

DV-603/DVF-3060

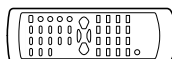

DVF-3060K



Batteries ... (2)

DV-603/DVF-3060 (R6/AA)



DVF-3060K (R03/AAA)

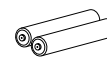

Coaxial cable ... (1)



*AC plug adaptor ... (1)

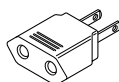

* Use to adapt the plug on the power cord to the shape of the wall outlet. (Accessory only for regions where use is necessary.)

For the U.S.A.

CAUTION:

Use of controls or adjustments or performance of procedures other than those specified herein may result in hazardous radiation exposure.

In compliance with Federal Regulations, the following are reproductions of labels on, or inside the product relating to laser product safety.

KENWOOD CORPORATION
2967-3, ISHIKAWA-CHO,
HACHIOJI-SHI,
TOKYO, JAPAN

KENWOOD CORP. CERTIFIES THIS EQUIPMENT
CONFORMS TO DHHS REGULATIONS NO. 21 CFR
1040.10, CHAPTER 1, SUBCHAPTER J.

Location: Back Panel

CAUTION- LASER RADIATION WHEN OPEN.
DO NOT STARE INTO BEAM.

Location: Laser Pick-up Unit Cover inside this product

For the U.S.A.

FCC WARNING

This equipment may generate or use radio frequency energy. Changes or modifications to this equipment may cause harmful interference unless the modifications are expressly approved in the instruction manual. The user could lose the authority to operate this equipment if an unauthorized change or modification is made.

NOTE:

This equipment has been tested and found to comply with the limits for a Class B digital device, pursuant to Part 15 of the FCC Rules. These limits are designed to provide reasonable protection against harmful interference in a residential installation. This equipment may cause harmful interference to radio communications, if it is not installed and used in accordance with the instructions. However, there is no guarantee that interference will not occur in a particular installation. If this equipment does cause harmful interference to radio or television reception, which can be determined by turning the equipment off and on, the user is encouraged to try to correct the interference by one or more of the following measures:

- Reorient or relocate the receiving antenna.
- Increase the separation between the equipment and receiver.
- Connect the equipment into an outlet on a circuit different from that to which the receiver is connected.
- Consult the dealer or an experienced radio / TV technician for help.

Please read all of the safety and operating instructions before operating this appliance. Adhere to all warnings on the appliance and in the instruction manual. Follow all the safety and operating instructions. These safety and operating instructions should be retained for future reference.

1. Power sources – The appliance should be connected to a power supply only of the type described in the instruction manual or as marked on the appliance. If you are not sure of the type of power supply to your home, consult your appliance dealer or local power company. For appliances intended to operate from battery power, or other sources, refer to the instruction manual.

2. Power-cord protection – Power-supply cords should be routed so that they are not likely to be walked on or pinched by items placed upon or against them, pay particular attention to cords at plugs, convenience receptacles, and the point where they exit from the appliance.

Never pull or stretch the cord.

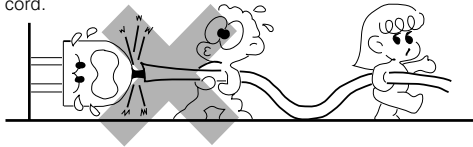

3. CAUTION – Polarization – This appliance may be equipped with a polarized alternating-current line plug (a plug having one blade wider than the other). This plug will fit into the power outlet only one way. This is a safety feature. If you are unable to insert the plug fully into the outlet, try reversing the plug. If the plug should still fail to fit, contact your electrician to replace your obsolete outlet. Do not defeat the safety purpose of the polarized plug.

4. Ventilation – Slots and openings in the cabinet are provided for ventilation and to ensure reliable operation of the appliance and to protect it from overheating, and these openings must not be blocked or covered. The appliance should be situated so that its location or position does not interfere with its proper ventilation.

To maintain good ventilation, do not put records or a tablecloth on the appliance. Place the appliance at least 10 cm away from the walls.

Do not use the appliance on a bed, sofa, rug or similar surface that may block the ventilation openings. This appliance should not be placed in a built-in installation such as a bookcase or rack unless proper ventilation is provided or the manufacturer's instructions have been adhered to.

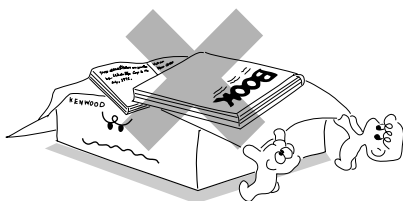

5. Water and moisture – The appliance shall not be exposed to dripping and splashing—for example, near a bathtub, washbowl, kitchen sink, laundry tub, in a wet basement, or near a swimming pool, etc. Do not place an object containing liquid, such as a flower vase, on the appliance.

6. Temperature – The appliance may not function properly if used at extremely low, or freezing temperatures. The ideal ambient temperature is above +5°C (41°F).

7. Heat – The appliance should be situated away from heat sources such as radiators, heat registers, stoves, or other appliances (including amplifiers) that produce heat. Do not place a flaming object, such as a candle or lantern, on or near the appliance.

8. Electric shock – Care should be taken so that objects do not fall and liquid is not spilled into the enclosure through openings. If a metal objects, such as a hair pin or a needle, comes into contact with the inside of this appliance, a dangerous electric shock may result. For families with children, never permit children to put anything, especially metal, inside this appliance.

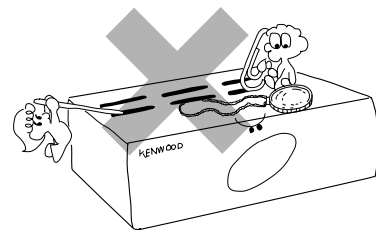

9. Enclosure removal – Never remove the enclosure. If the internal parts are touched accidentally, a serious electric shock might occur.

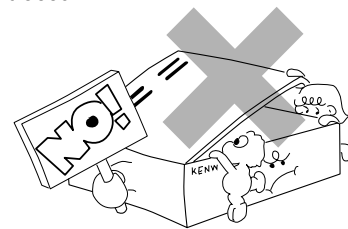

10. Magnetic fields – Keep the appliance away from sources of magnetic fields such as TV sets, speaker systems, radios, motorized toys or magnetized objects.

11. Cleaning – Unplug this appliance from the wall outlet before cleaning. Do not use volatile solvents such as alcohol, paint thinner, gasoline, or benzene, etc. to clean the cabinet. Use a clean dry cloth.

12. Accessories – Do not place this appliance on an unstable cart, stand, tripod, bracket, or table. The appliance may fall, causing serious injury to a child or adult, and serious damage to the appliance. Use only with a cart, stand, tripod, bracket, or table recommended by the manufacturer, or sold with the appliance. Any mounting of the appliance should follow the manufacturer's instructions, and should use a mounting accessory recommended by the manufacturer. An appliance and cart combination should be moved with care. Quick stops, excessive force, and uneven surfaces may cause the appliance and cart combination to overturn.



13. Lightning – For added protection for this appliance during a lightning storm, or when it is left unattended and unused for long periods of time, unplug it from the wall outlet and disconnect the antenna or cable system. This will prevent damage to the appliance due to lightning and power-line surges.

14. Abnormal smell – If an abnormal smell or smoke is detected, immediately turn the power OFF and unplug the appliance from the wall outlet. Contact your dealer or nearest service center.

POWER OFF!

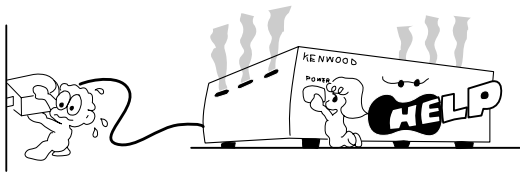

15. Damage requiring service – The appliance should be serviced by qualified service personnel when:

- A.** The power-supply cord or the plug has been damaged.
- B.** Objects have fallen, or liquid has been spilled into the appliance.
- C.** The appliance has been exposed to rain or water.
- D.** The appliance does not appear to operate normally by following the instruction manual. Adjust only those controls that are covered by the instruction manual as an improper adjustment of other controls may result in damage and will often require extensive work by a qualified technician to restore the appliance to its normal operation.
- E.** The appliance has been dropped, or the enclosure damaged.
- F.** The appliance exhibits a marked change in performance.

16. Servicing – The user should not attempt to service the appliance beyond that described in the instruction manual. All other servicing should be referred to qualified service personnel.

17. Outdoor antenna grounding– If an outside antenna is connected to the appliance, be sure the antenna system is grounded so as to provide some protection against voltage surges and built up static charges. Article 810 of the National Electrical Code ANSI/NFPA 70, provides information with respect to proper grounding of the mast and supporting structure, grounding of the lead-in wire to an antenna discharge unit, size of grounding conductors, location of antenna discharge unit, connection to grounding electrodes, and requirements for the grounding electrode. See Figure.

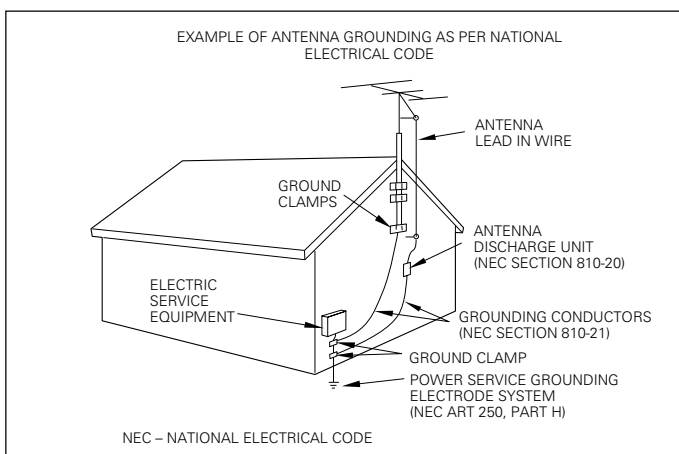

18. Power lines – An outside antenna system should not be located in the vicinity of overhead power lines or other electric light or power circuits, or where it can fall into such power lines or circuits. When installing an outside antenna system, extreme care should be taken to keep from touching such power lines or circuits as contact with them might be fatal.

19. AC outlets – Do not connect other audio equipment with a power consumption larger than that specified to the AC outlet on the rear panel. Never connect other electrical appliances, such as an iron or toaster, to it to prevent fire or electric shock.

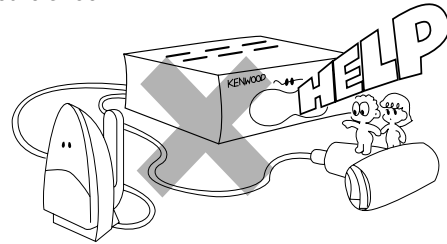

20. Overloading – Do not overload wall outlets, extension cords, or integral convenience receptacles as this can result in a risk of fire or electric shock.

21. Attachment – Do not use attachments not recommended by the appliance manufacturer as they may cause hazards.

22. Replacement parts–When replacement parts are required, be sure the service technician has used replacement parts specified by the manufacturer or have the same characteristics as the original parts. Unauthorized substitutions may result in fire, electric shock, or other hazards.

23. Safety check – Upon completion of any service or repairs to this appliance, ask the service technician to perform safety checks to determine that the appliance is in proper operating condition.

Notes:

1. Item 3 is not required except for grounded or polarized equipment.
2. Item 17 and 18 are not required except for units provided with antenna terminals.
3. Item 17 complies with UL in the U.S.A.

Special features

This document classifies the applications of each feature using the following marks.

- DVD** : Description of a feature that can be used with DVD.
- CD** : Description of a feature that can be used with CD.
- VCD** : Description of a feature that can be used with VCD.



DVD **Higher video quality than S-VHS video and LaserDisc**

DVD **Higher audio quality than music CD**

DVD **CD** **VCD** **Graphical user interface (GUI) compatibility**

DVD **Versatile DVD playback features**

DVD **CD** **DTS digital output compatibility**

Contents

Caution : Read the pages marked carefully to ensure safe operation.

Preparations

Introduction	2
Before applying power	2
Safety precautions	2
IMPORTANT SAFEGUARDS	4
Special features and Contents	6
Special features	6
Contents	6
Discs information	7
Types of playable discs	7
Unplayable discs	7
Icons on the DVD VIDEO discs	7
Region Codes	8
Region codes in the world	8
Video formats	9
Important items	10
Maintenance	10
Reference	10
System Connections	11
Connecting to a TV with video (composite) input terminal	11
Connecting to a TV with S-video input terminal	11
Connecting to a TV with SCART input terminal (For Europe and U.K.)	11
Connecting to a TV with Component input terminals (For other countries)	12
Connecting to an Audio component	12
Controls and indicators	13
Operation of remote control unit	14

Operations

Playback of disc	16
Basic play	16
Disc playback features	17
Using the On-screen banner display	19
Selecting a Title	20
Selecting a Chapter or Track	20
Select Audio Language	21
Select Subtitle Language	21
Select Camera angle	22
Using IntroScan function	22









Using Bookmarks	23
Repeat play	24
A-B Repeat play	24
Random play	25
Program play	26
Set Up functions	28
Set up menu	28
Select Audio Language	29
Select Subtitle Language	29
Select Menu Language	30
Select Rating	30
Password	31
TV aspect	33
Dynamic Range	34
Digital Audio Out	34
Linear PCM	35
Menu playback	36
Hierarchical structure of VCD menus	36
Playback without using the menu playback function (In case of a P.B.C.-compatible VCD) (To P.B.C. On or Off)	37
Selecting the Audio channel	37
Enjoying karaoke singing	38
Selecting the Audio channel	38
Controlling the key of the music (KEY CONTROL)	38
Adjust the ECHO level	39
HIT MASTER function	39
MP3 function	40
Guidance of MP3	40
Playing back MP3	41
Selecting MP3 files	42
MP3 Repeat play	43
MP3 Random play	43
MP3 program playback	44
DVD menu language code list	45

Knowledge

In case of difficulty	46
Specifications	48

Types of playable discs



The system using this unit does not only play music from CD but can also play the discs listed below to offer you high-quality entertainment of video of movies and live concerts.

Playable Disc		DVD VIDEO		CD (CD-R, CD-RW)		VCD
Logo mark on disc		 				
Disc size		 8cm	 12cm	 8cm	 12cm	 12cm
Played sides		One or both	One or both	One side only	One side only	One side only
Contents	Video + Audio	Approx. 41 min. (1 side, 1 layer) Approx. 75 min. (1 side, 2 layers) Approx. 82 min. (2 sides, 1 layer) Approx. 150 min. (2 sides, 2 layers)	Approx. 133 min. (1 side, 1 layer) Approx. 242 min. (1 side, 2 layers) Approx. 266 min. (2 sides, 1 layer) Approx. 484 min. (2 sides, 2 layers)	/		Max. 74 min.
	Audio	/		Max. 20 min., digital	Max. 74 min., digital	







MP3 media that can be played back with this equipment (CD-R, CD-RW) → 

Unplayable discs

This player cannot play back any of the following discs.

<p>DVD AUDIO discs DVD-ROM discs DVD-R/DVD-RAM/DVD-RW discs CD-ROM discs (Except MP3 disc [ISO 9660 level 1]) VSD discs</p> <ul style="list-style-type: none"> • A DVD VIDEO disc with a region code which does not match this unit or without a region code. For details, see "Region Codes". →  • When the video format of a disc differs from that of the TV in use, the disc cannot be played normally. For details, see "Video Formats". →  • This unit may also be incapable of playing certain CD-R/RW discs depending on their properties, recording conditions, etc. 	<p>S-VCD discs CDV discs (Only the audio part can be reproduced.) CD-G/CD-EG/CD-EXTRA discs (Only the audio can be reproduced.) Photo CD discs (Never attempt to play them.)</p>
--	---

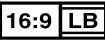
Icons on the DVD VIDEO discs

Icon	Description
	Indicates the region code where the disc can be played.
	Number of voice languages recorded with the audio function. The number in the icon indicates the number of voice languages. (Max. 8 languages)
	Number of subtitle languages recorded with the subtitle function. The number in the icon indicates the number of subtitle languages. (Max. 32 languages)
	Number of angles provided by the angle function. The number in the icon indicates the number of angles. (Max. 9 angles)
	Aspect ratios that can be selected. "LB" stands for Letter Box and "PS" for Pan/Scan. →  →  In the example on the left, the 16:9 video can be converted into letter box video.

Every player of this model has a certain region code assigned to it based on the country where the player is used. When the player is used to play back DVD VIDEO discs, it can only play the DVD VIDEO discs carrying the region codes matching the region code of the player.

The region code for this player is described on the rear panel of the player.

Region codes in the world

The DVD players are given a region code according to the country or area it is marketed, as shown in the following map.

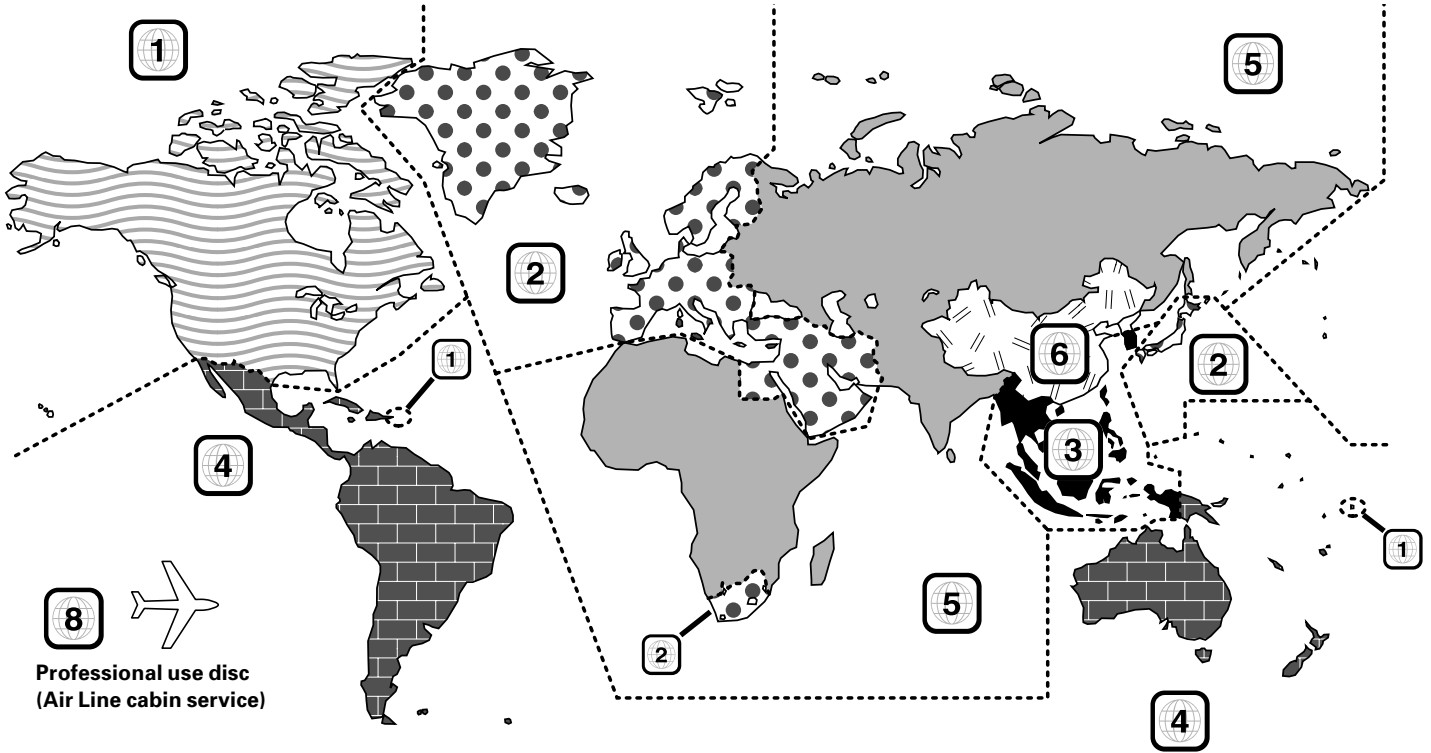

Region codes of the DVD VIDEO discs that can be played with this player

This player can play back a DVD VIDEO disc which carries the corresponding code to the region code of the player shown in the table above, a marking containing the region code of the player or the "ALL" marking shown below. Even when a DVD VIDEO disc does not carry any indication of the region code, it may sometimes be unable to be played on this player due to certain restrictions.



Restrictions due to difference between discs

Some DVD and VCD discs can be played only in certain playback modes according to the intentions of the software producers. As this player plays discs according to their intentions, some functions may not work as intended by you. Please be sure to read the instructions provided with each disc. When an inhibition icon is displayed on the TV screen connected to the player, it indicates that the disc being played is under the restriction as described above.

Inhibition icon



The TV picture display and disc signal systems can be divided roughly into two TV formats (NTSC and PAL).

They are variable depending on countries and areas.

TV formats of major countries

TV Format	Major Countries & Areas
NTSC	Japan, Taiwan, Korea, USA, Canada, Mexico, Philippines, Chile, etc.
PAL	China, U.K., Germany, Australia, New Zealand, Kuwait, Singapore, etc.

(For U.S.A. , Canada and U.S. Military)

This unit reproduces NTSC discs in NTSC format. (This unit can not play PAL discs.)

(For other countries)

This unit reproduces NTSC discs in NTSC format and PAL discs in PAL format.

- If the video formats of the disc and TV do not match, the disc cannot be reproduced correctly. It is therefore required to select the disc according to the TV set in use (country and area).

Checking the Video Format

Check the video format of the VCD and DVD discs to be played on the player as described below.

① Check if the video formats of the TV to be used and disc to be played match each other.

- For details, refer to the instructions provided with the TV and disc.

② When the TV is switchable between NTSC and PAL, set the TV format according to the disc format.

TV Format	Playable Disc Format
NTSC only	NTSC
PAL only	PAL
NTSC/PAL switchable	NTSC/PAL

- Correct video cannot be reproduced if the video formats of the TV and disc do not match.

When the video formats are different :

Try playing the disc. If the video formats of the disc and TV do not match, the played video may be black and white or become as shown below.

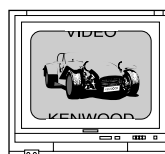

Top and bottom edges are not displayed.

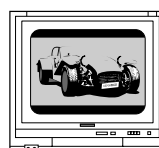

Top and bottom areas are dark.

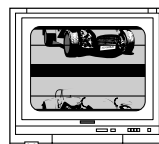

Picture turbulence due to sync unmatching.

Maintenance

Maintenance of the unit

When the front panel or case becomes dirty, wipe with a soft, dry cloth. Do not use thinner, benzine, alcohol, etc. for these agents may cause discoloration.

In regard to contact cleaner

Do not use contact cleaners because it could cause a malfunction. Be specially careful not to use contact cleaners containing oil, for they may deform the plastic component.

Reference

Disc handling precautions

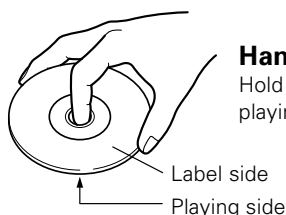

Handling

Hold the disc so that you do not touch the playing surface.

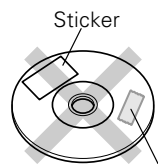

Do not attach paper or tape to either the playing side or the label side of the disc.

Sticky paste

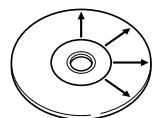

Cleaning

If there are fingerprint marks or foreign matter found on the disc, lightly wipe the disc with a soft cotton cloth (or similar) from the center of the disc outwards in a radial manner.

Storage

When a disc is not to be played for a long period of time, remove it from the player and store it in its case.

Never play a cracked or warped disc

During playback, the disc rotates at high speed in the player. Therefore, to avoid danger, never use a cracked or deformed disc or a disc repaired with tape or adhesive agent. Please do not use discs which are not round because they may cause malfunction.

Disc accessories

The disc accessories (stabilizer, protection sheet, protection ring, etc.) which are marketed for improving the sound quality or protecting discs as well as the disc cleaner should not be used with this system because they may cause malfunction.

Note related to transportation and movement

Before transporting or moving this unit, carry out the following operations.

1. Set the **POWER ON/OFF switch to the ON without loading a disc.**
2. **Wait a few seconds and verify that the display shown appears.**

NO DISC

3. Set the **POWER ON/OFF switch to OFF.**

Caution on condensation

Condensation (of dew) may occur inside the unit when there is a great difference in temperature between this unit and the outside. This unit may not function properly if condensation occurs. In this case, leave the unit for a few hours and restart the operation after the condensation has dried up.

Be specially cautious against condensation in the following circumstances:

When this unit is carried from one place to another across a large difference in temperature, when the humidity in the room where this unit is installed increases, etc.

Make connections as shown below.
When connecting the related system components, refer also to the instruction manuals of the related components.

Caution:
Do not plug in the power lead until all connections are completed.

Malfunction of microcomputer

If operation is not possible or erroneous display appears even though all connections have been made properly, reset the microcomputer referring to "In case of difficulty". → 46

Caution

Be sure to adhere to the following, or proper ventilation will be blocked causing damage or fire hazard.

- Do not place any objects impairing heat radiation onto the top of the unit.
- Leave some space around the unit (from the largest outside dimension including projection) equal to or greater than, shown below.

Top panel : 50 cm Side panel : 10 cm Back panel : 10 cm

Connecting to a TV with video (composite) input terminal

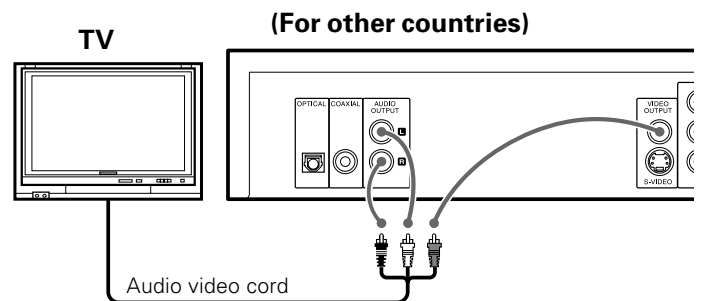
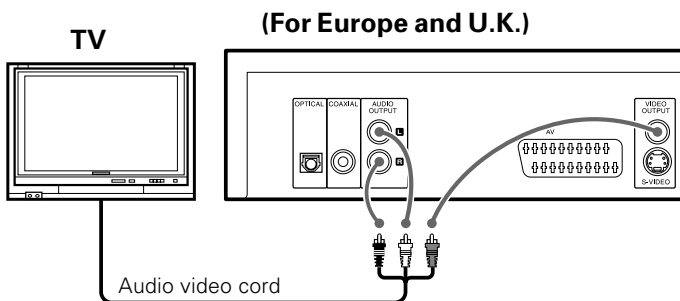

Connecting to a TV with S-video input terminal

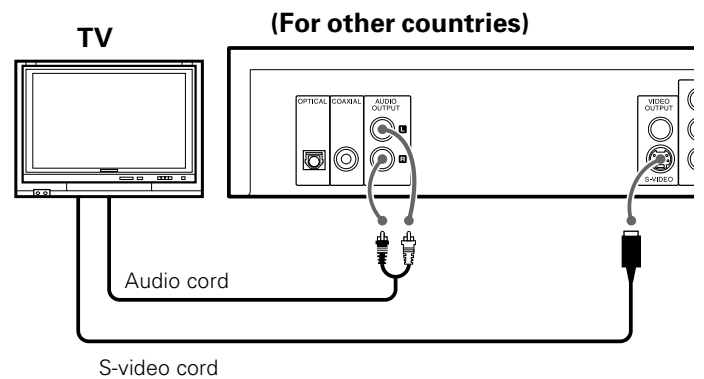
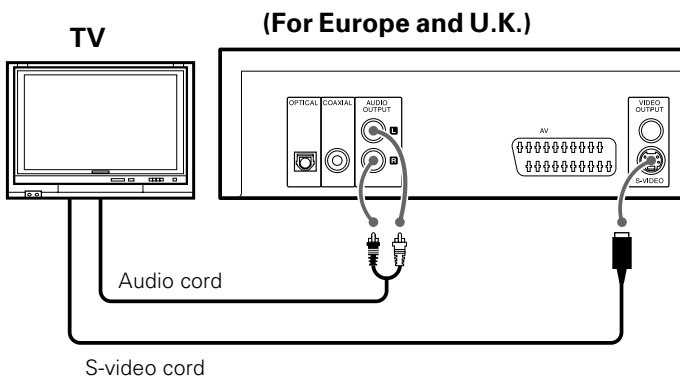

Connecting to a TV with SCART input terminal (For Europe and U.K.)

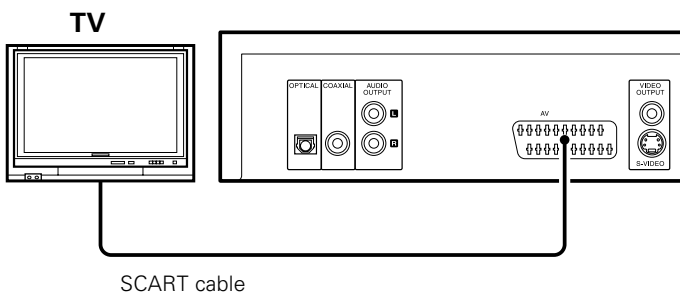

Connecting to a TV with Component input terminals (For other countries)

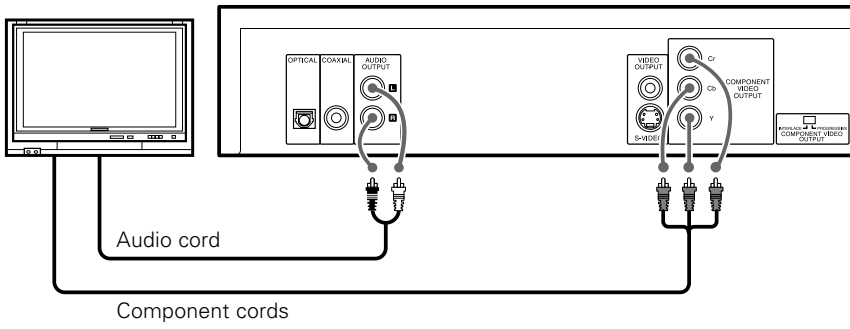

[For U.S.A. and Canada]
 Select the scanning method of the Component Video output using the COMPONENT VIDEO OUTPUT switch on the rear panel.

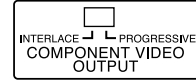

INTERLACE: Scanning method is fixed at interlaced scanning.
PROGRESSIVE: When progressive scanning is unavailable with certain discs, the scanning method is switched automatically to interlaced scanning. When the scanning method is changed, the scanning status will be displayed for a few seconds.

Connecting to an Audio component

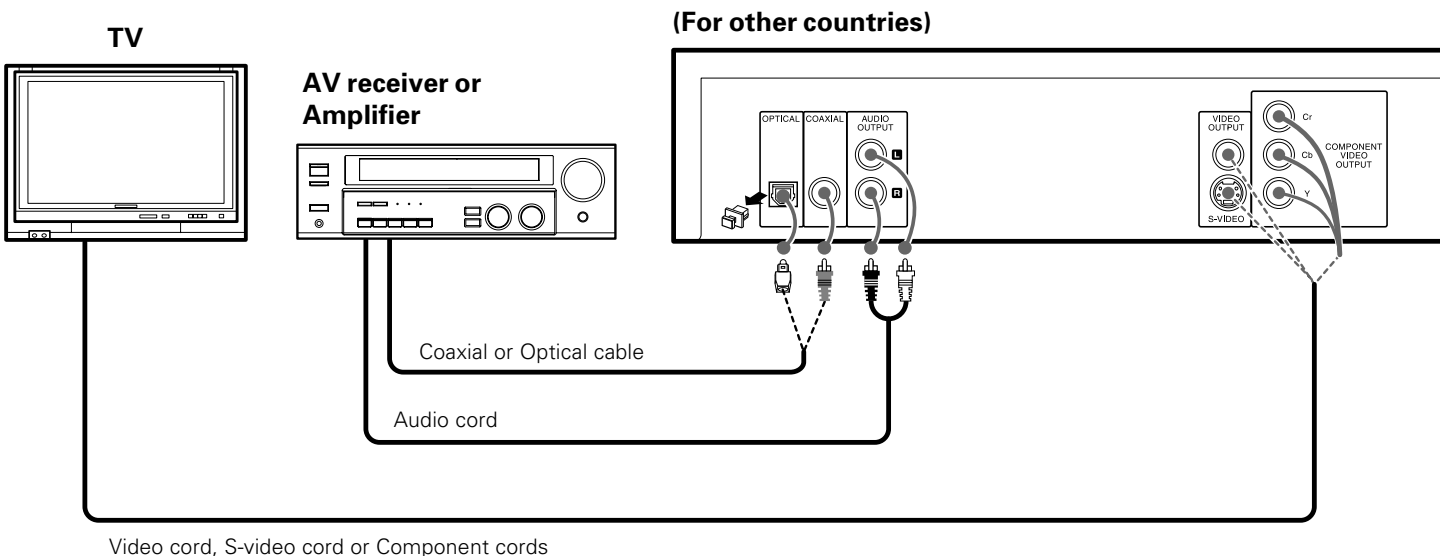
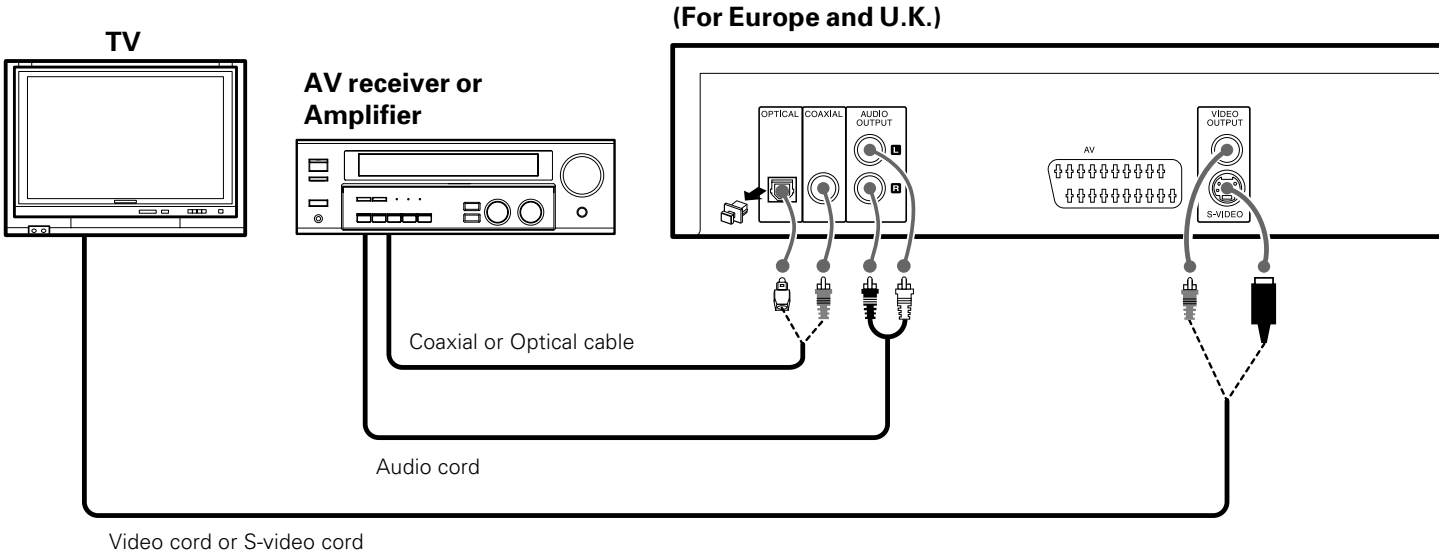

1. In case an associated system component is connected, also read the instruction manual of the component.
2. Insert the optical-fiber cable straight into the connector until it clicks.
3. Never bend or bundle the optical-fiber cable.

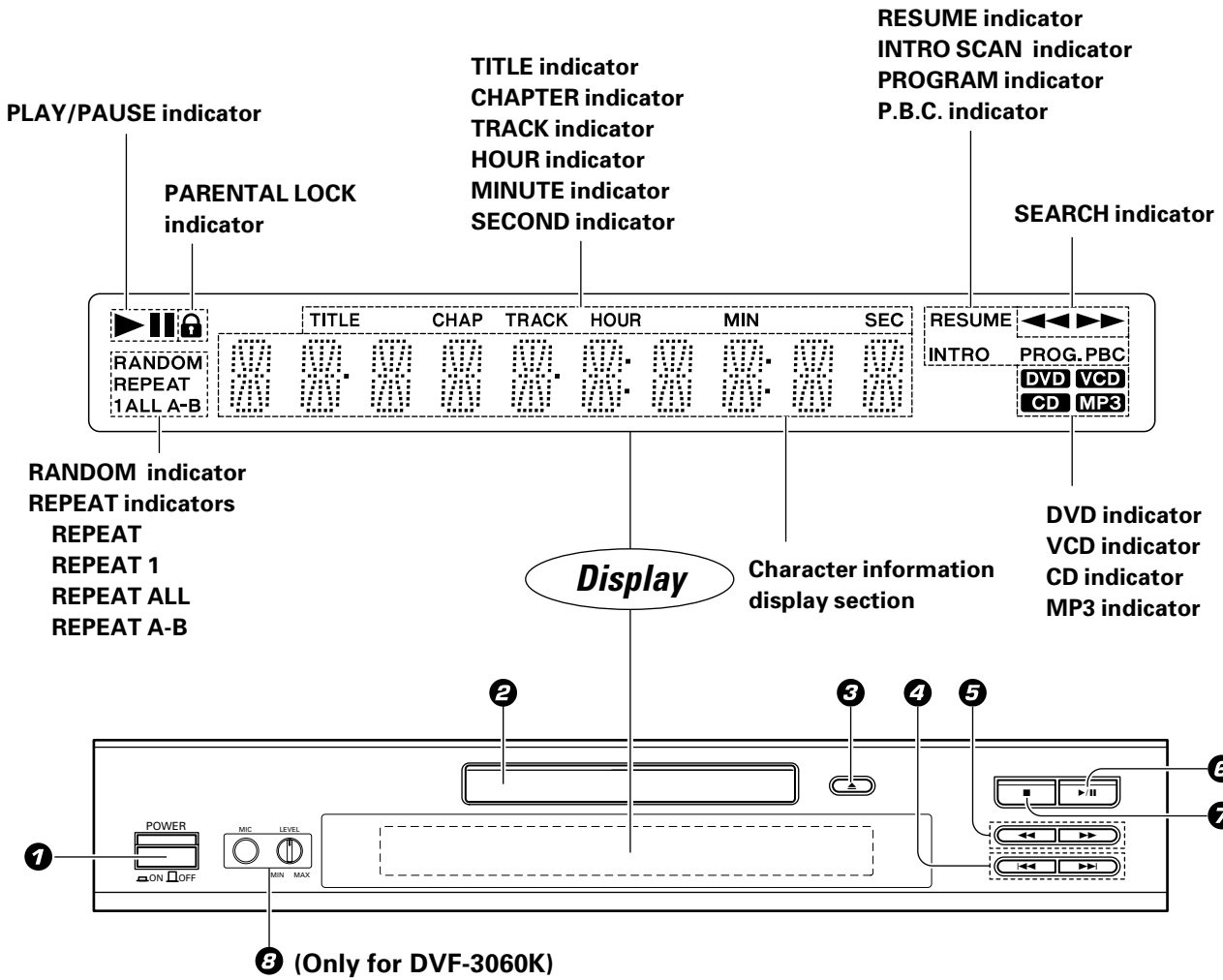

- | | | | |
|--|------|--|------|
| 1 POWER ON / OFF switch | → 16 | 6 ▶/ (Play/Pause) key | → 16 |
| 2 Disc tray | → 16 | 7 ■ (Stop) key | → 16 |
| 3 ▲ (Open/Close) key | → 16 | 8 MIC jack (Only for DVF-3060K) | → 38 |
| 4 ◀◀(PREV.), ▶▶(NEXT) (Skip) keys | → 17 | MIC LEVEL control knob | |
| 5 ◀◀, ▶▶ (Search) keys | → 17 | (Only for DVF-3060K) | → 38 |

DIMMER function

The display brightness of the main unit can be changed.

DV-603/DVF-3060

DIMMER



DVF-3060K

DIMMER



Switching as shown below is done each time the DIMMER key on the remote control is pressed.

- ① Dim
- ② Not lit
- ③ Bright

DV-603/DVF-3060

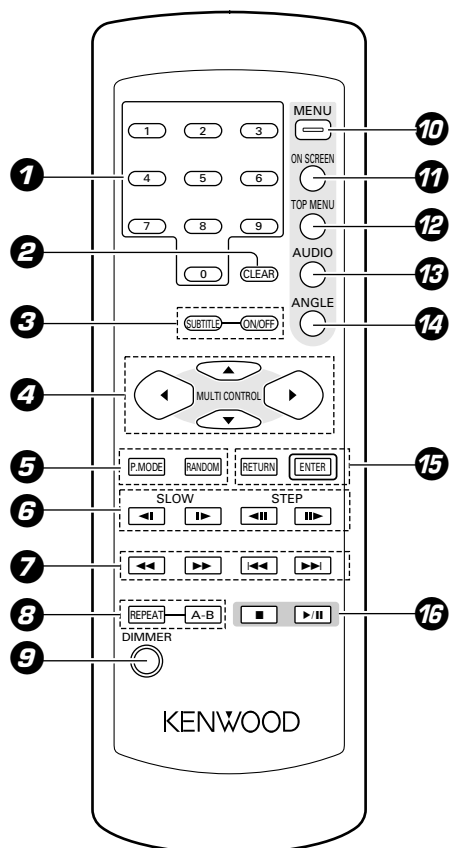

The keys on the remote control unit with the same names as on the main unit have the same function as the keys on the main unit.

- | | | | | | |
|--|---|--------|-----------------------|---|--------|
| ① Numeric keys | - | 20 | ⑨ DIMMER key | - | 13 |
| ② CLEAR key | - | 19 | ⑩ MENU key | - | 28 |
| ③ SUBTITLE key | - | 21 | ⑪ ON SCREEN key | - | 19 |
| ④ Cursor Up (▲), Down (▼), Left (◀) and Right (▶) keys | - | 19, 28 | ⑫ TOP MENU key | - | 16, 37 |
| ⑤ P.MODE key | - | 26 | ⑬ AUDIO key | - | 21, 37 |
| ⑥ SLOW (Back slow/ Forward slow) keys | - | 17 | ⑭ ANGLE key | - | 22 |
| ⑦ ◀◀ key/▶▶ key (Search key) | - | 17 | ⑮ RETURN key | - | 28 |
| ◀◀ (PREV.) key/▶▶ (NEXT) key (Skip key) | - | 17 | ENTER key | - | 19 |
| ⑧ REPEAT key | - | 24 | ■ (Stop) key | - | 16 |
| A-B Repeat key | - | 24 | ▶/ (Play/Pause) key | - | 16 |

Model : RC-D0307 (Infrared ray system)

Loading batteries

① Remove the cover.

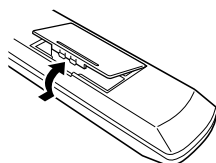

② Insert batteries.

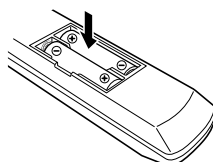

③ Close the cover.

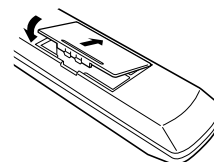

- Insert two R6/LR6 ("AA"-size) batteries following the polarity indications.

Operation

Insert the power plug into a power outlet, press the POWER ON / OFF switch of the main unit to ON, then press the desired remote control key.

- When pressing more than one remote control keys successively, press the keys securely by leaving an interval of 1 second or more between pressing of keys.

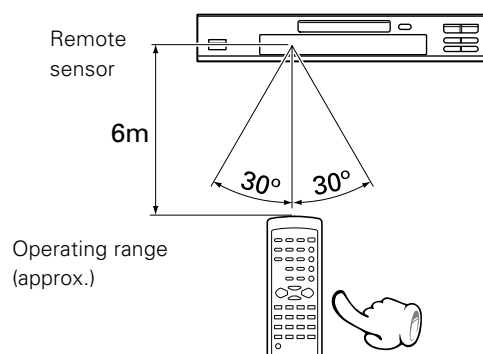

1. The provided batteries are intended for use in operation checking, and their service life may be short.
2. When the remote controllable distance becomes short, replace both of the batteries with new ones.
3. If direct sunlight or the light of a high-frequency fluorescent lamp (inverter type, etc.) is incident to the remote sensor, malfunction may occur. In such a case, change the installation position to avoid malfunction.

DVF-3060K

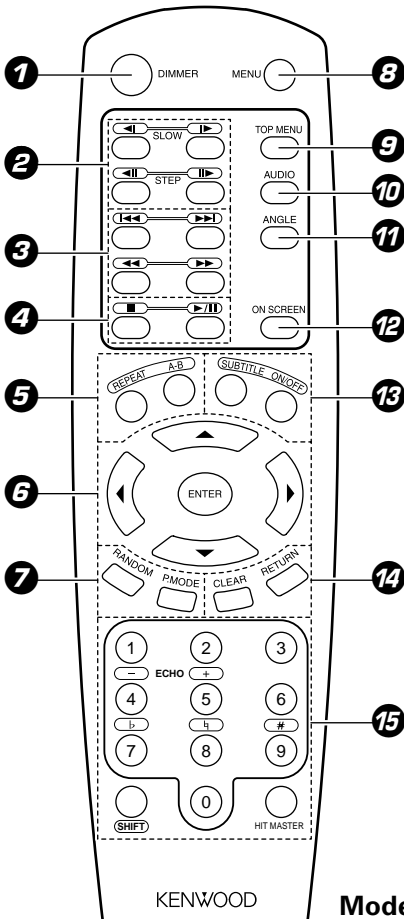

The keys on the remote control unit with the same names as on the main unit have the same function as the keys on the main unit.

- | | | | |
|--|------------|--------------------------------------|------------|
| ① DIMMER key | - 13 | ⑧ MENU key | - 28 |
| ② SLOW (Back slow/ Forward slow) keys | - 17 | ⑨ TOP MENU key | - 16, - 37 |
| ③ STEP (Back step/ Forward step) keys | - 17 | ⑩ AUDIO key | - 21, - 38 |
| ③ ◀◀ (PREV.) key/ ▶▶ (NEXT) key (Skip key) | - 17 | ⑪ ANGLE key | - 22 |
| ◀◀ key/▶▶ key (Search key) | - 17 | ⑫ ON SCREEN key | - 19 |
| ④ ■ (Stop) key | - 16 | ⑬ SUBTITLE key (SUBTITLE) ON/OFF key | - 21 |
| ▶/ (Play/Pause) key | - 16 | ⑭ RETURN key | - 28 |
| ⑤ REPEAT key | - 24 | ⑮ CLEAR key | - 19 |
| A-B Repeat key | - 24 | ⑮ Numeric keys | - 20 |
| ⑥ Cursor Up (▲), Down (▼), Left (◀) and Right (▶) keys | - 19, - 28 | ⑮ KARAOKE keys | - 39 |
| ENTER key | - 19 | ⑮ ECHO keys | - 39 |
| ⑦ RANDOM key | - 25 | ⑮ Key Control keys | - 38 |
| P.MODE key | - 26 | ⑮ HIT MASTER key | - 39 |
| | | ⑮ SHIFT key | - 38 |

Model : RC-D0311 (Infrared raysystem)

Loading batteries

① Remove the cover.

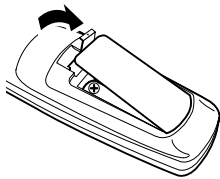

② Insert batteries.

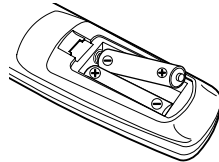

③ Close the cover.

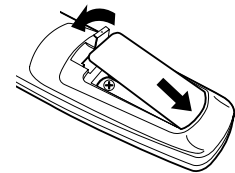

- Insert two R03 ("AAA"-size) batteries following the polarity indications.

Operation

Insert the power plug into a power outlet, press the POWER ON / OFF switch of the main unit to ON, then press the desired remote control key.

- When pressing more than one remote control keys successively, press the keys securely by leaving an interval of 1 second or more between pressing of keys.

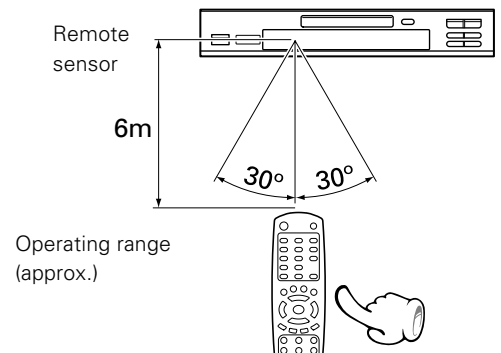

1. The provided batteries are intended for use in operation checking, and their service life may be short.
2. When the remote controllable distance becomes short, replace both of the batteries with new ones.
3. If direct sunlight or the light of a high-frequency fluorescent lamp (inverter type, etc.) is incident to the remote sensor, malfunction may occur. In such a case, change the installation position to avoid malfunction.

Basic play

Preparation

MAIN UNIT

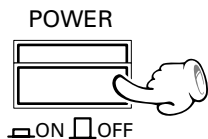

- Set the **POWER ON/OFF** switch to the ON () position.
- After the power is switched ON, there is a delay of about 3 seconds before the display is lit.

DV-603/DVF-3060

DVF-3060K

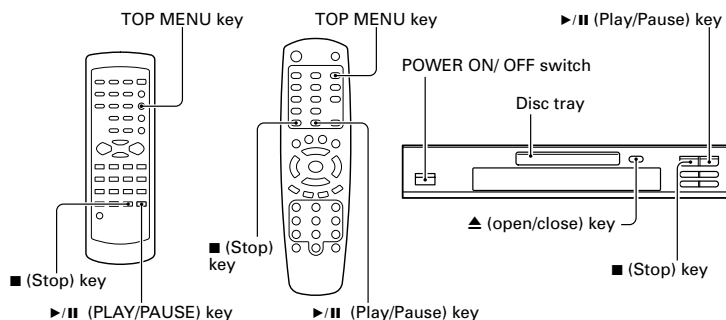

1 Load a disc.

MAIN UNIT

- 1 Open the tray.



- 2 Place a disc.

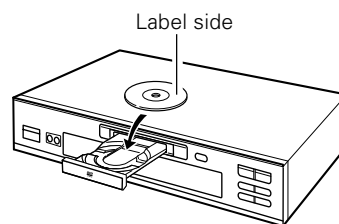

2 Start playback.

MAIN UNIT

REMOTE



DV-603/DVF-3060



DVF-3060K



- When the ►/|| key is pressed while a tray is open, the tray closes automatically, and then playback begins.

TITLE No. (DVD)

CHAPTER No. (DVD)

Time display



TRACK No. (CD/VCD)

- Each press pauses and plays the disc alternately.

When a menu screen is recorded on the disc, the menu screen will be displayed when the TOP MENU key or MENU key is pressed. At the menu screen, the menu can be selected by pressing the Cursor keys.

DV-603/DVF-3060

TOP MENU



DVF-3060K

TOP MENU



When a Disc Menu appears on the screen

In case of interactive DVDs, a Disc Menu appears on the screen. Then press **ENTER** to select specific menu you want to play by using Cursor keys.

To stop playback

MAIN UNIT

REMOTE

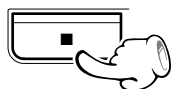

DV-603/DVF-3060



DVF-3060K

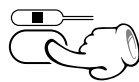

RESUME playback

When the ■ (Stop) key has been pressed once during playback to stop the playback, and then playback is started again, play will start from the point where the playback had been stopped. This is called the RESUME function. When the ■ (Stop) key is pressed again during stop, the RESUME function is cancelled.

RESUME is cancelled when 5 minutes have passed in RESUME status.

Disc playback features



- You won't hear the sound (audio) on the DVD when you're using the Skip, Search, Step or Slow motion features.
- Playback features are not available during the opening credits of a movie.

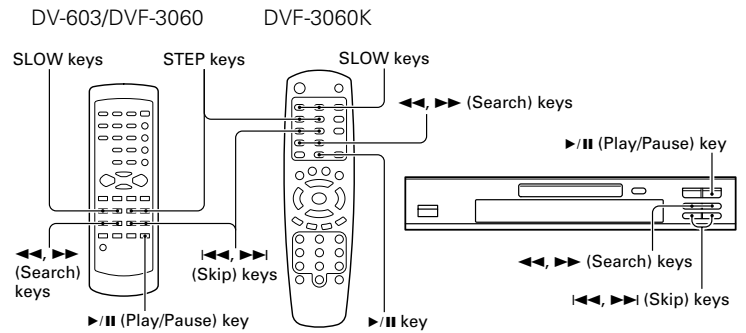

CD DVD VCD **Skipping chapters or tracks**

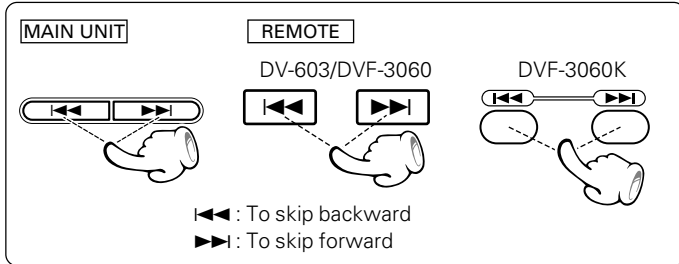

- The chapter (or track) in the direction of the key pressed is skipped, and the selected chapter (or track) will be played from the beginning.
- When the ◀◀ key is pressed once during playback, the chapter (or track) being played will be played from the beginning.

CD DVD VCD **Searching**

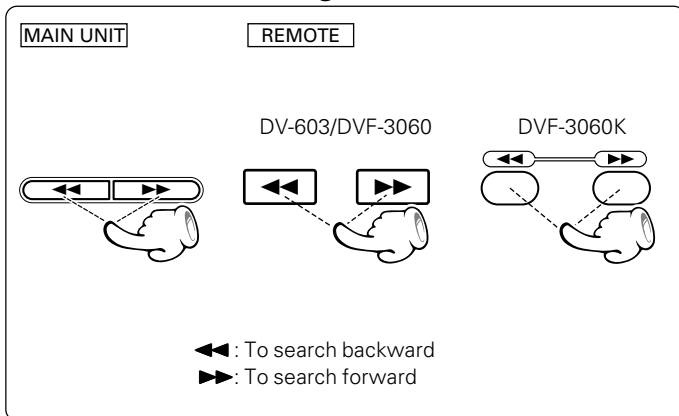

- During playback, press the ◀◀ or ▶▶ key.
- Each press switches the searching speed.

(At the time of DVD playback)

- ① X 2 (F.SEARCH 1)/(R.SEARCH 1)
- ② X 4 (F.SEARCH 2)/(R.SEARCH 2)
- ③ X 8 (F.SEARCH 3)/(R.SEARCH 3)
- ④ X 16 (F.SEARCH 4)/(R.SEARCH 4)

(At the time of CD/VCD playback)

- ① X 2 (F.SEARCH 1)/(R.SEARCH 1)*
- ② X 4 (F.SEARCH 2)/(R.SEARCH 2)
- ③ X 8 (F.SEARCH 3)/(R.SEARCH 3)

* No audio is output during the fast forward or fast reverse operation at the 2x speed (①) of DTS-CD.

- Press the ▶/|| key at any time to resume normal playback.

DVD VCD **STEP (freeze frame and frame advance)**

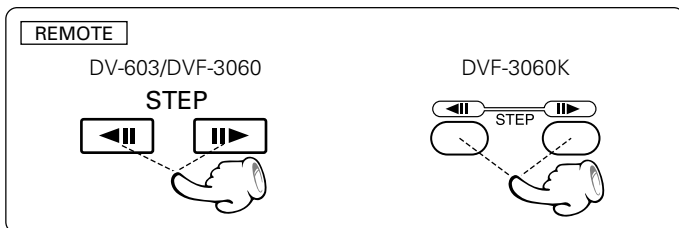

- During playback, press the **STEP** keys.
- Each time you press the keys, the picture advances one frame.
- At the time of VCD playback, backward STEP is not possible.
- Press the ▶/|| key to resume normal playback.

DVD VCD **Slow motion playback**

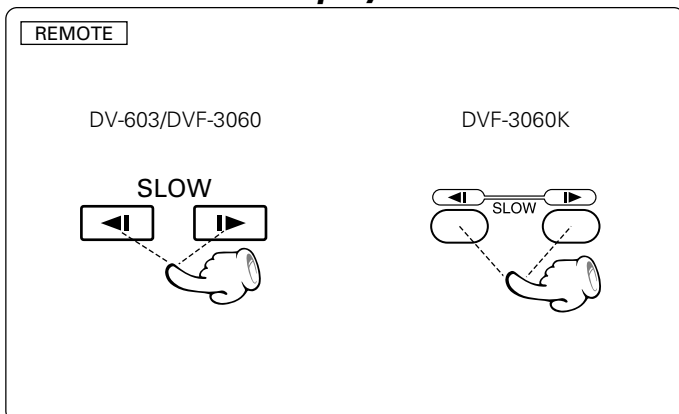

- During playback, press the **SLOW** keys.
- Each press switches the motion speed.

(At the time of DVD playback)

- ① F.SLOW 1/16 (R.SLOW 1/16)
- ② F.SLOW 1/8 (R.SLOW 1/8)
- ③ F.SLOW 1/4 (R.SLOW 1/4)
- ④ F.SLOW 1/2 (R.SLOW 1/2)

(At the time of VCD playback)

- ① F.SLOW 1/8 (R.SLOW is not possible)
- ② F.SLOW 1/4 (R.SLOW is not possible)
- ③ F.SLOW 1/2 (R.SLOW is not possible)

- Press the ▶/|| key to resume normal playback.

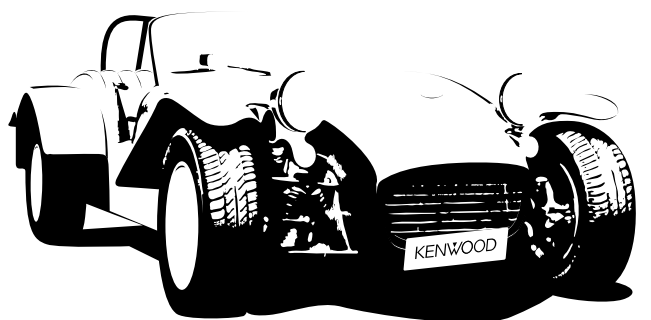

The on-screen Banner Display contains many playback features. To see the Banner Display, press ON SCREEN key on the remote while a disc is playing. Use the Cursor (◀/▶) keys on the remote to move through the different features in the Banner Display. Each feature is illustrated with an icon.

① During playback, press the ON SCREEN key on the remote.



② Press the Cursor left/right (◀/▶) keys to highlight a banner display icon.

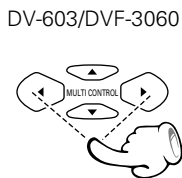

③ Press the ENTER key.



To display disappear from the screen

Press the ON SCREEN key or CLEAR key.



or

or



When playing a DVD

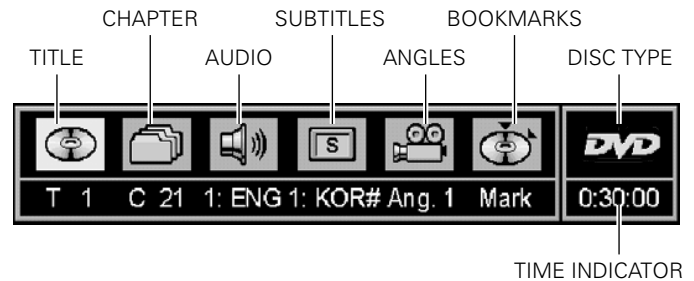

When playing a CD/VCD

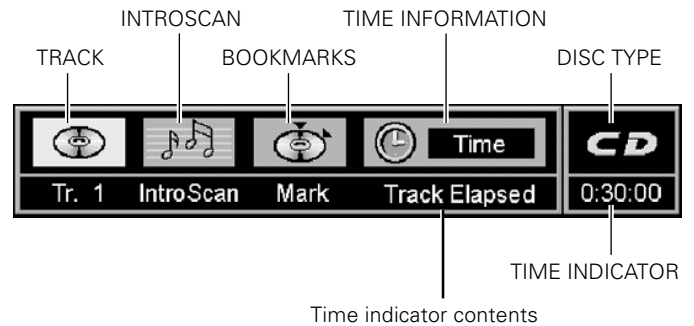

Switch the CD/VCD time indicator as follows.

- ① Select the time information with the cursor key.
- ② Each time the ENTER key is pressed, the time indicator changes as follows.
 - ① "Track Elapsed" : Elapsed time of the track being played
 - ② "Track Remain" : Remaining time of the track being played
 - ③ "Disc Elapsed" : Elapsed time of the disc being played
 - ④ "Disc Remain" : Remaining time of the disc being played



- You can only access the banner display when you're playing a disc.
- The banner display feature are only available if the disc was created with that particular feature (i.e., if you select the Subtitle icon, you won't be able to change the subtitle language unless the author of the disc created the disc with subtitles).
- The invalid symbol ⊗ appears on the screen when you press a key that doesn't have any function. If one of the icons is "grayed out," the banner display feature isn't available for the disc you're playing.

DVD Selecting a Title

Some discs contain more than one title. For example, there might be four movies on one disc (each movie might be considered a title).

- ① During playback, press the ON SCREEN key on the remote.

DV-603/DVF-3060

ON SCREEN



DVF-3060K

ON SCREEN



- ② Press the Cursor left/right (◀/▶) keys until the TITLE icon is highlighted.

DV-603/DVF-3060

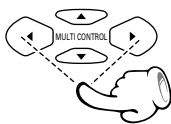

DVF-3060K

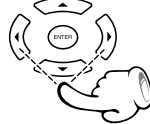

- ③ Press the ENTER key. ("T_" appears)

DV-603/DVF-3060



DVF-3060K



- ④ Use the numeric keys to enter the title number.

DV-603/DVF-3060

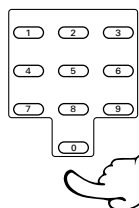

DVF-3060K

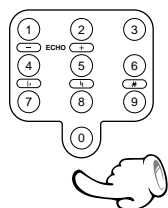

When you enter a one-digit Title number, you may have to press the ENTER key on the remote after pressing the numeric key (1~9) on the remote. Otherwise press 0 first and the other value. Then play starts. This varies depending on number of Title within the disc you're playing.



Some discs only have one title.

DVD CD VCD Selecting a Chapter or Track

Because DVD VIDEO discs use digital technology, a title can be divided into individual chapters (similar to tracks on a CD). You can skip a specific chapter by using the Chapter section in the Banner Display.

- ① During playback, press the ON SCREEN key on the remote.

DV-603/DVF-3060

ON SCREEN



DVF-3060K

ON SCREEN



- ② Press the Cursor left/right (◀/▶) keys until the CHAPTER or TRACK icon is highlighted.

DV-603/DVF-3060

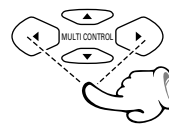

DVF-3060K

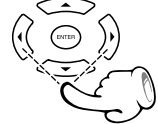

- ③ Press the ENTER key. ("C_" or "Tr_" appears)

DV-603/DVF-3060



DVF-3060K



- ④ Use the numeric keys to enter the chapter or track number.

DV-603/DVF-3060

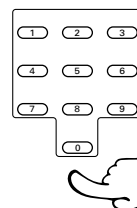

DVF-3060K

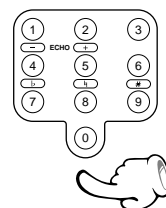

When you enter a one-digit chapter or track number, you may have to press the ENTER key on the remote after pressing the numeric key (1~9) on the remote. Otherwise press 0 first and the other value. Then play starts. This varies depending on number of chapter or track within the disc you're playing.



- The Chapter feature won't work if the disc isn't formatted with separate chapters.
- P.B.C. on mode of VCD, the Selecting a Track function may not work. → 37

Select Audio Language

If the disc was created with different language tracks, you can use the Banner Display to temporarily change the DVD player's Audio setting.

Using the on-screen banner display

- 1 During playback, press the ON SCREEN key on the remote.

DV-603/DVF-3060
ON SCREEN



DVF-3060K
ON SCREEN



- 2 Press the Cursor left/right (◀/▶) keys until the AUDIO icon is highlighted.

DV-603/DVF-3060

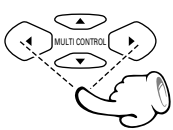

DVF-3060K

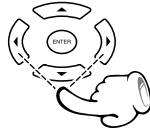

- 3 Press the ENTER key.

DV-603/DVF-3060



DVF-3060K



The audio menu appears

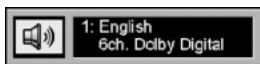

- 4 Select the audio language with press the ENTER key.

- The menu is switched off when no operation is performed for about 5 seconds.

Using the AUDIO key on the remote

- 1 During playback, press the AUDIO key on the remote.

DV-603/DVF-3060

AUDIO



DVF-3060K

AUDIO



- 2 Select the audio language with press the ENTER key or AUDIO key.

- The menu is switched off when no operation is performed for about 5 seconds.



1. The language feature only works if the disc was created with multiple audio tracks.
2. When you chose an audio language from the Banner Display, you only override the audio language setting in the DVD Player's main menu (in the Language Preferences menu within Setup menu) temporarily.

Select Subtitle Language

You can change the Subtitle language while you're watching a disc (but only if the disc was created with subtitles).

Using the on-screen banner display

- 1 During playback, press the ON SCREEN key on the remote.

DV-603/DVF-3060
ON SCREEN



DVF-3060K
ON SCREEN



- 2 Press the Cursor left/right (◀/▶) keys until the SUBTITLE icon is highlighted.

DV-603/DVF-3060

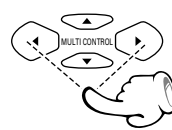

DVF-3060K

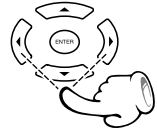

- 3 Press the ENTER key.

DV-603/DVF-3060



DVF-3060K



The subtitle menu appears

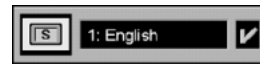

Displayed when
SUBTITLE is ON

- 4 Select the subtitle language with press the ENTER key.

- 5 Press the SUBTITLE ON/OFF key to subtitle ON or OFF.

- The menu is switched off when no operation is performed for about 5 seconds.

Using the SUBTITLE key on the remote

- 1 During playback, press the SUBTITLE key on the remote.

DV-603/DVF-3060

SUBTITLE



DVF-3060K

SUBTITLE



- 2 Select the subtitle language with press the ENTER key or SUBTITLE key.

- 3 When the SUBTITLE ON/OFF key is pressed, subtitles will be displayed. Switching between display of subtitles and no display of subtitles is done each time the key is pressed.

DV-603/DVF-3060

ON/OFF



DVF-3060K

ON/OFF



Displayed when
SUBTITLE is ON



1. The subtitle feature only works if the disc was created with multiple subtitle tracks.
2. The subtitle menu of the disc appears in some discs.

Select Camera angle

Some disc contains multiple angles particular scene or sequence. If the disc only has one angle, this feature won't work.

Using the on-screen banner display

- 1 During playback, press the ON SCREEN key on the remote.

DV-603/DVF-3060
ON SCREEN



DVF-3060K
ON SCREEN



- 2 Press the Cursor left/right (◀/▶) keys until the ANGLE icon is highlighted.

DV-603/DVF-3060

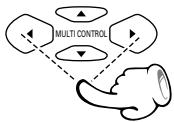

DVF-3060K



- 3 Press the ENTER key.

DV-603/DVF-3060



DVF-3060K



The ANGLE menu appears



- 4 Select the angle with press the ENTER key.

- The menu is switched off when no operation is performed for about 5 seconds.

Using the ANGLE key on the remote

- 1 During playback, press the ANGLE key on the remote.

DV-603/DVF-3060

ANGLE



DVF-3060K

ANGLE



- 2 Select the Camera angle with press the ENTER key or ANGLE key.

- The menu is switched off when no operation is performed for about 5 seconds.

Using IntroScan function

IntroScan plays the first few seconds of each track on the CD similar to the scan feature that's on many car radios.

Using the on-screen banner display

- 1 During playback, press the ON SCREEN key on the remote.

DV-603/DVF-3060
ON SCREEN



DVF-3060K
ON SCREEN



- 2 Press the Cursor left/right (◀/▶) keys until the IntroScan icon is highlighted.

DV-603/DVF-3060

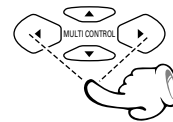

DVF-3060K



- 3 Press the ENTER key.

DV-603/DVF-3060



DVF-3060K



- The first 10 seconds of each track play.
- After Intro Scan goes through all of the tracks, it stops.
- If you want to stop IntroScan while it's in progress, just press **ENTER** key on the remote (the current track starts playing in its entirety).



P.B.C. on mode of VCD, the IntroScan function may not work. → 37

DVD CD VCD Using Bookmarks

The bookmark feature lets you mark a point on the disc that you can go to quickly. You can store up to 9 bookmarks.

Create the bookmark

- 1 During playback, press the ON SCREEN key on the remote.

DV-603/DVF-3060
ON SCREEN



DVF-3060K
ON SCREEN



- 2 Press the Cursor left/right (◀/▶) keys until the BOOKMARK icon is highlighted.

DV-603/DVF-3060

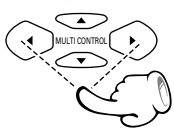

DVF-3060K

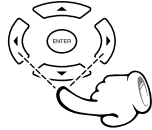

- 3 Press the ENTER key.

DV-603/DVF-3060



DVF-3060K



Return to the previous banner display

The bookmark menu appears



- 4 When you reach the scene you want to mark, press ENTER key.

DV-603/DVF-3060



DVF-3060K



The bookmark appears on under square



- Press the **ON SCREEN** key or **CLEAR** key to switch the menu off.

Clearing a bookmark

- The bookmark is cleared each time a disc is removed from the player or when the power is turned off.



- If all 9 bookmarks are in use, you can still mark new scenes, but the previous bookmarks will be erased.
- Depending on the disc, the Bookmark function may not work.
- P.B.C. on mode of VCD, the Bookmark function may not work. → 37

Recalling a bookmarked scene

- 1 During playback, press the ON SCREEN key on the remote.

DV-603/DVF-3060
ON SCREEN



DVF-3060K
ON SCREEN



- 2 Press the Cursor left/right (◀/▶) keys until the BOOKMARK icon is highlighted.

DV-603/DVF-3060

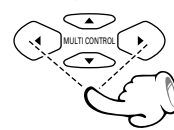

DVF-3060K

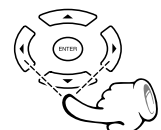

- 3 Press the ENTER key.

DV-603/DVF-3060



DVF-3060K



The bookmark appears on under square



- 4 Press the Cursor up (▲) key on the remote to go the parts of the Bookmark menu.

DV-603/DVF-3060



DVF-3060K



- 5 Use the Cursor left/right (◀/▶) keys on the remote to select the bookmarked scene you want to activate.

DV-603/DVF-3060

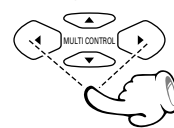

DVF-3060K

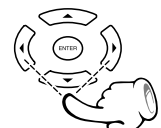

- 6 Press the ENTER key to active the bookmark.

DV-603/DVF-3060



DVF-3060K



- You can go to bookmarked scene by the numeric key (1~9) on the step 5.
- Press the **ON SCREEN** key or **CLEAR** key to switch the menu off.

DVD CD VCD Repeat play

Desired title or disc can be played back repeatedly.

- "Repeat Disc" : Repeat the disc that is playing.
- "Repeat Title" : Repeat the title that is playing.
- "Repeat Chapter" : Repeat the chapter that is playing.
- "Repeat Track" : Repeat the track that is playing.

During playback, press the REPEAT key on the remote.

DV-603/DVF-3060



DVF-3060K



The Repeat display appears



Each press the key switches the REPEAT mode

At the time of DVD playback

- ① "Repeat Disc" : Display lit "REPEAT ALL"
- ② "Repeat Title" : Display lit "REPEAT"
- ③ "Repeat Chapter" : Display lit "REPEAT 1"
- ④ "Repeat Off"

At the time of CD/VCD playback

- ① "Repeat Disc" : Display lit "REPEAT ALL"
- ② "Repeat Track" : Display lit "REPEAT 1"
- ③ "Repeat Off"

At the time of REPEAT mode
"REPEAT" is light.

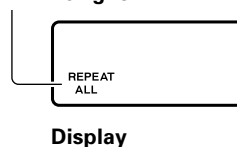

- To cancel repeat playback, press the REPEAT key and select "Repeat off".
- The menu is switched off when no operation is performed for about 5 seconds.

"MP3 Repeat play" → 43



P.B.C. on mode of VCD, the Repeat play function may not work. → 37

DVD CD VCD A-B Repeat play

The A-B repeat function lets you mark a segment to repeat between the beginning "A" and the end "B" of the segment you want to replay.

- ① Press the A-B key on the remote when you want to choose a scene (sound) as the beginning point.

DV-603/DVF-3060



DVF-3060K

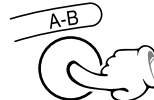

The Repeat A- display appears

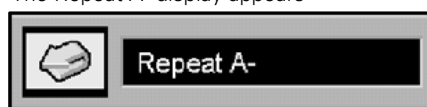

Lit

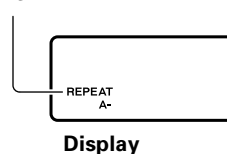

- ② Press the A-B key again to choose a scene (sound) as the end point.

DV-603/DVF-3060

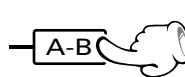

DVF-3060K

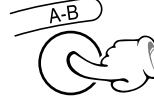

The Repeat A-B display appears

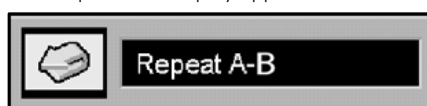

Lit

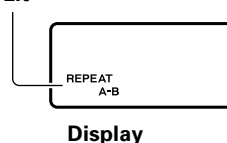

- To cancel A-B Repeat playback, press the A-B key and select "Repeat off".
- The menu is switched off when no operation is performed for about 5 seconds.



P.B.C. on mode of VCD, the A-B Repeat play function may not work. → 37

CD VCD *Random play*

The tracks of the disc are played in random order.

During playback or stop mode, press **RANDOM** key on the remote.

DV-603/DVF-3060



DVF-3060K



The Random Play display appears



Lit



Display

Each time you press **RANDOM** key on the remote, random play would be on and off.

- ① "Random Play"
- ② "Standard Play"

The Standard Play display appears when random is off



- The menu is switched off when no operation is performed for about 5 seconds.

"MP3 Random play" → 43



- When the **RANDOM** key is pressed during playback, the tracks of the disc being played will be selected in random order for playback.
- After all tracks of a disc have been played in random order, playback will stop. (Random mode will be cancelled.)
- When playing a DVD, the Random function may not work.
- P.B.C. on mode of VCD, the Random play function may not work. → 37

To repeat random play

During random playback, press the **REPEAT** key on the remote.

DV-603/DVF-3060



DVF-3060K



Each press the key switches the mode.

- ① Display lit "**REPEAT ALL**"
- ② Repeat canceled

You can listen to the desired tracks or chapters of the current disc in any desired order.

Program Edit

① During stop mode, press the P.MODE key on the remote.

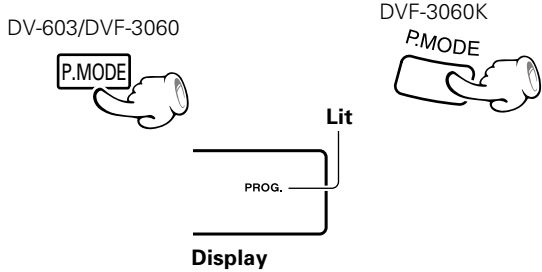

② Select specific title/chapter or track by Press Cursor up/down (▲/▼) keys or numeric keys (0-9).



③ Press the ENTER key.



④ Select "Add" icon on the screen to register selected value onto Playlist, then press the ENTER key.

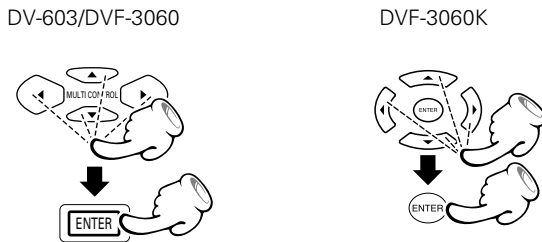

⑤ You can select maximum 32 values by repeating step ② - ④.

⑥ Press the ►/|| key to start playback.

Program edit display appears.

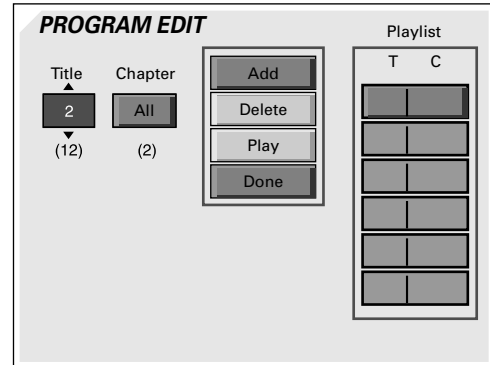

(An example of DVD program edit menu)

- : Selected icon
- : An icon which can be selected
- : An icon which presently can not be selected

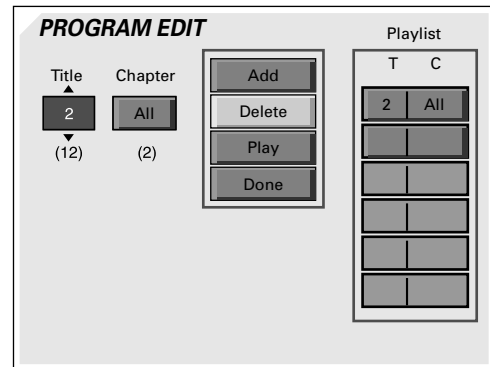

- "Add" icon : Add value onto "Playlist"
- "Delete" icon : Delete value from "Playlist"
- "Insert" icon : Insert value in "Playlist"
- "Play" icon : Play program play
- "Done" icon : Return to stop or resume mode

- When you don't add values onto "Playlist" and return to play mode, select "Done" icon and press ENTER key on the remote.
- While a disc is playing, press P.MODE key on the remote to start Program play
- To return to standard play, press the P.MODE key again.
- MP3 discs can not be programmed with this program mode. (MP3 program play → 44)

To repeat program play

During program playback, press the REPEAT key on the remote.



Each press the key switches the mode.

- ① Display lit "REPEAT ALL"
- ② Repeat canceled

Insert chapter or track

During stop mode, press the P.MODE key on the remote

- 1 Select specific title/chapter or track to insert by Press Cursor up/down (▲/▼) keys or numeric keys (0-9).

DV-603/DVF-3060



DVF-3060K

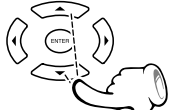

- 2 Move the cursor with the Cursor right (▶) key to the "Playlist" and select the column to be added with the Cursor up/down (▲/▼) keys. (The color of the column where the Cursor is located will change.)

DV-603/DVF-3060

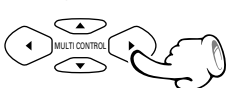

DVF-3060K

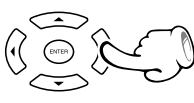

- 3 Press the Cursor left (◀) key, use the Cursor up/down (▲/▼) keys to move the Cursor to the "Insert" icon, and press the ENTER key.

DV-603/DVF-3060

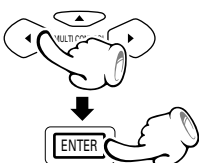

DVF-3060K

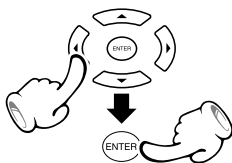

The new chapter or track will be inserted before (above) the selected column.

Program edit display appears.

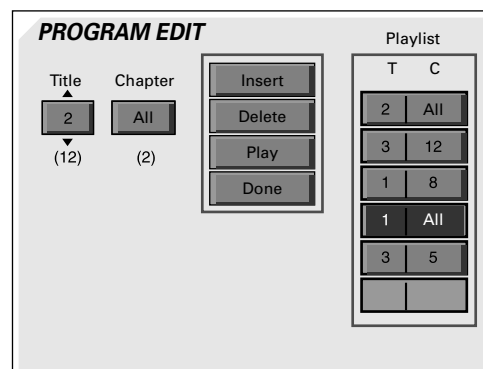

(An example of DVD program edit menu)

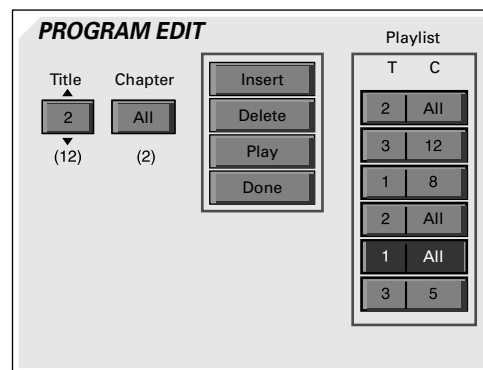

Delete Program

During stop mode, press the P.MODE key on the remote

- 1 Move the cursor with the Cursor right (▶) key to the "Playlist" and select the column to be deleted with the Cursor up/down (▲/▼) keys. (The color of the column where the Cursor is located will change.)

DV-603/DVF-3060

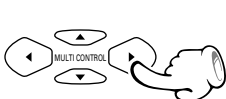

DVF-3060K

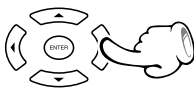

- 2 Press the Cursor left (◀) key, use the Cursor up/down (▲/▼) keys to move the Cursor to the "Delete" icon, and press the ENTER key. Or press the CLEAR key.

DV-603/DVF-3060

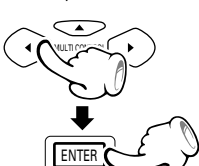

DVF-3060K

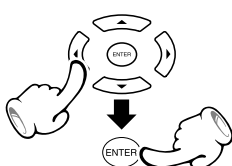

Selected value deletes

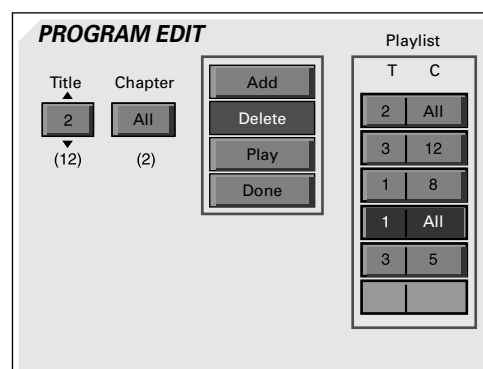

Release Program play

In following case, Program play would be released.

1. When you open and close tray.
2. When you turn power off and on.



P.B.C. on mode of VCD, the Program play function may not work. → 37

Set up menu

The initial setup of the player, which has been made at the factory, can be changed to the desired setup.

- ❶ During stop mode or resume mode, press MENU key on the remote.

DV-603/DVF-3060

MENU



DVF-3060K



Current setup menu display appears on the screen.

- ❷ Press Cursor up/down (▲/▼) keys on the remote to select the item, then press the ENTER key to access the sub features

DV-603/DVF-3060

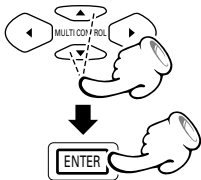

DVF-3060K

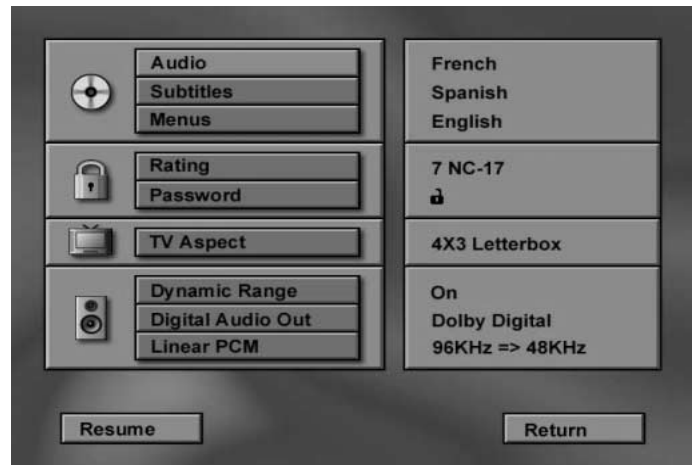
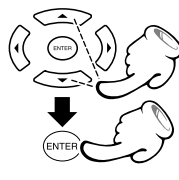

(Menu display example)

- Audio / Subtitle (Disc languages)** : This sets the language to be used when playing a disc. (If a disc does not contain the recording the selected language, it is played in the priority language set for each disc.)
- Menus** : This sets the initial setup of language as well as the language used in on-screen messages such as "PLAY".
- Rating** : This can restrict playback of adult-oriented DVD discs that you do not want to be seen by children. However, even when a DVD disc is marked "Adult-oriented" or so on the label, its viewing cannot be restricted unless the restriction level is recorded in the disc itself.
- Password** : The password for rating setting, change, cancellation, etc. is set.
- TV Aspect** : This sets the screen size (4:3 or 16:9 aspect ratio) according to the connected TV.
- 4 x 3 letterbox** : Choose this setting if you would prefer to see movies in their original aspect ratio. You will see the entire frame of the movie, but it will occupy a smaller portion of the screen. This setting may result in the movie appearing with black bars at the top and bottom of the screen.
 - 4 x 3 Pan Scan** : Choose this setting if you want the movie to fill the entire screen of your TV. You won't see part of the picture (particularly the right and left edge). Some disc produced in a wide screen format can't be cropped in this fashion, which means the black bars would appear at the top and the bottom of the screen.
 - 16 x 9 Widescreen** : Choose this setting if your DVD player is connected to a widescreen TV.
- Dynamic Range** : This is set to ON when the volume change should not become overly large, for example when listening late at night.
- Digital Audio Out** : This sets the type of audio output from the digital audio output jack.
- Linear PCM** : The player can output digital signal with maximum sampling rate of 96 kHz from the digital audio output connector. When a DVD disc recorded in high sampling rate PCM is played, this setting makes it possible to select whether the signal is converted into 48 kHz signal.

How to use the RETURN key

When the RETURN key is pressed, the display returns to the previous screen (STOP mode).

DV-603/DVF-3060



DVF-3060K



DVD Select Audio Language

- Press Cursor up/down (▲/▼) keys on the remote to select "Audio" on the set up menu display, then press the ENTER key.

DV-603/DVF-3060

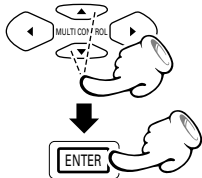

DVF-3060K

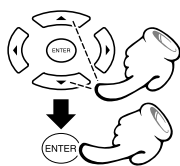

(Audio menu appears.)

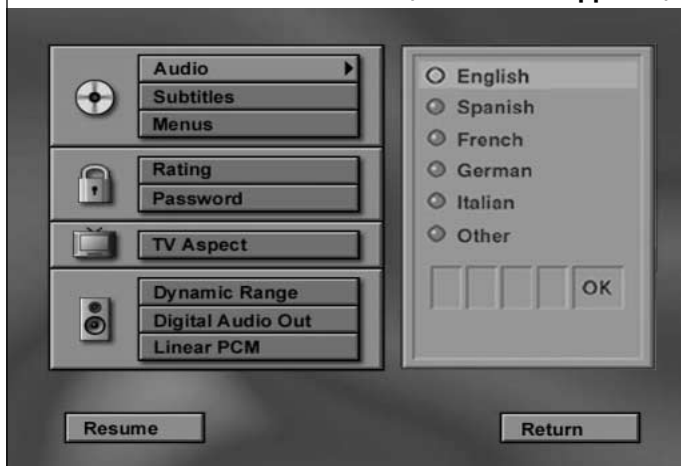

- Press Cursor up/down (▲/▼) keys on the remote to select specific Audio language, then press the ENTER key.

DV-603/DVF-3060

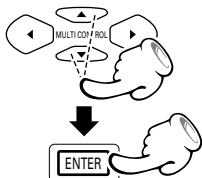

DVF-3060K

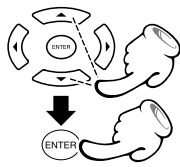

To select other language

- Select "Other" and press ENTER key



- Input code in the first digit by Press Cursor up/down (▲/▼) keys or numeric keys on the remote and repeat other 4 code with same way.

- Press the ENTER key on "OK" icon.
(DVD menu language code list - (45))

- Press ►/|| key to resume normal playback.

DVD Select Subtitle Language

- Press Cursor up/down (▲/▼) keys on the remote to select "Subtitles" on the set up menu display, then press the ENTER key.

DV-603/DVF-3060

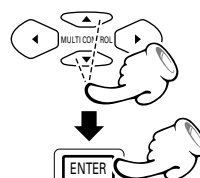

DVF-3060K

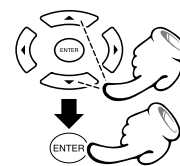

(Subtitle menu appears.)

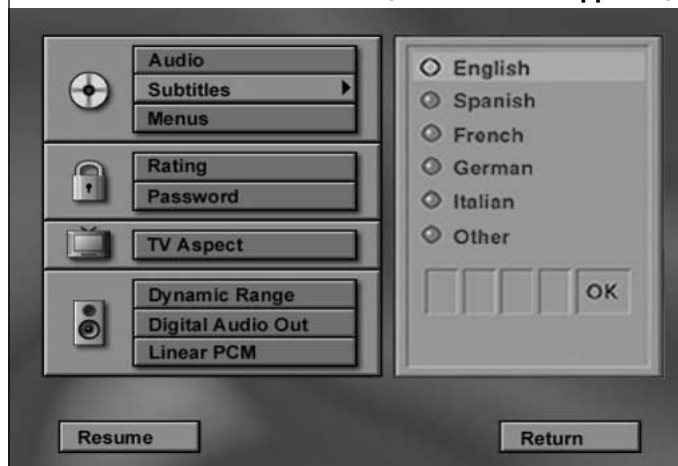

- Press Cursor up/down (▲/▼) keys on the remote to select specific Subtitle language, then press the ENTER key.

DV-603/DVF-3060

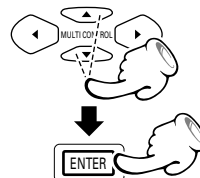

DVF-3060K

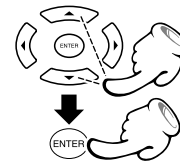

To select other language

- Select "Other" and press ENTER key



- Input code in the first digit by Press Cursor up/down (▲/▼) keys or numeric keys on the remote and repeat other 4 code with same way.

- Press the ENTER key on "OK" icon.
(DVD menu language code list - (45))

- Press ►/|| key to resume normal playback.

DVD Select Menu Language

- Press Cursor up/down (▲/▼) keys on the remote to select "Menus" on the set up menu display, then press the ENTER key.

DV-603/DVF-3060

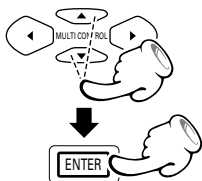

DVF-3060K

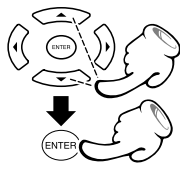

(Menus appears.)

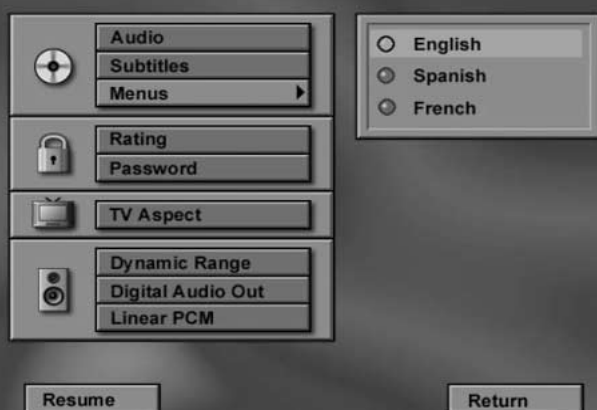

- Press Cursor up/down (▲/▼) keys on the remote to select specific Menu language, then press the ENTER key.

DV-603/DVF-3060

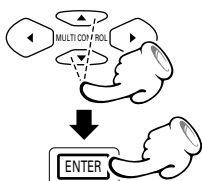

DVF-3060K

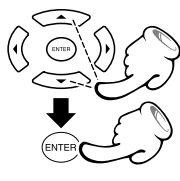

- Press ►/|| key to resume normal playback.

DVD Select Rating

This part of DVD rating lets you determine how your player will react discs that contain movies that are rated (in the U.S.A. the Motion Pictures Association of America rates movies as G, PG, PG-13, etc.).

- Press Cursor up/down (▲/▼) keys on the remote to select "Rating" on the set up menu display, then press the ENTER key.

DV-603/DVF-3060

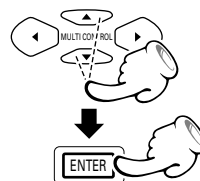

DVF-3060K

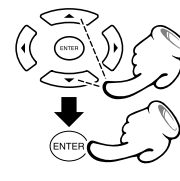

When a password already has been set, the screen for change of the entered password will be displayed. In that case, enter the password. → 31

(Rating aspect menu appears.)

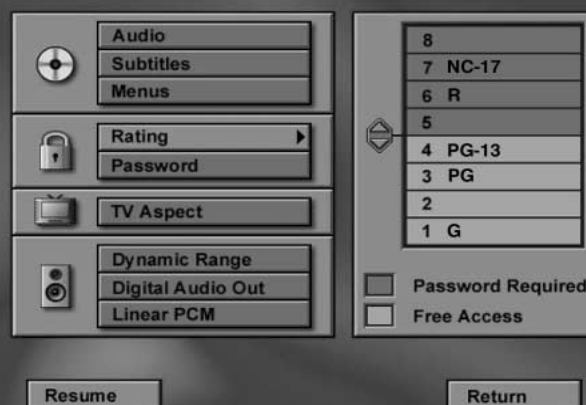

- Press Cursor up/down (▲/▼) keys on the remote to highlight rated titles, then press the ENTER key.

DV-603/DVF-3060

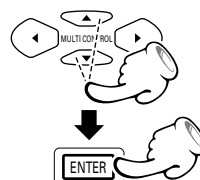

DVF-3060K

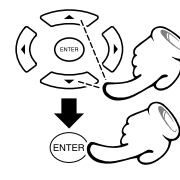

- Press ►/|| key to resume normal playback.

Parental lock level

- Level 8: All DVDs can be played back. (Factory preset)
- Level 7 to 2: DVDs for general audiences/children can be played back. (DVDs for adults are prohibited.)
- Level 1: DVDs for children can be played back. (DVDs for adults/general audiences are prohibited.)

DVD Password

Set password

- Press Cursor up/down (▲/▼) keys on the remote to select "Password" on the set up menu display, then press the ENTER key.

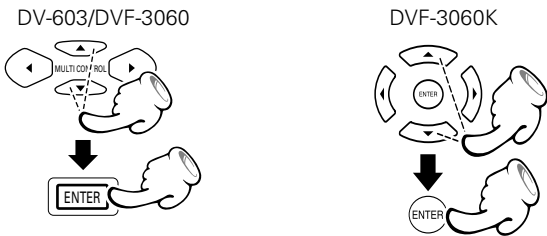

(Password menu appears.)

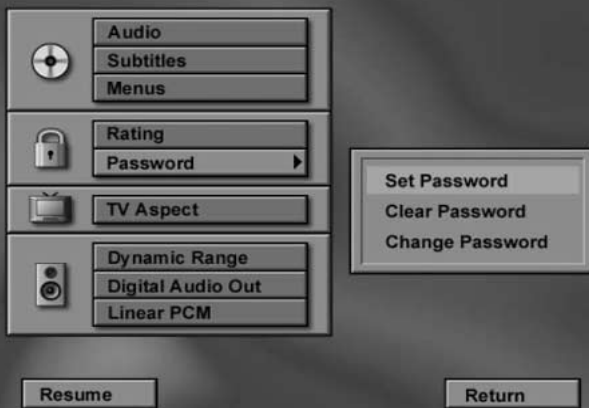

- After select "Set Password", press the ENTER key.

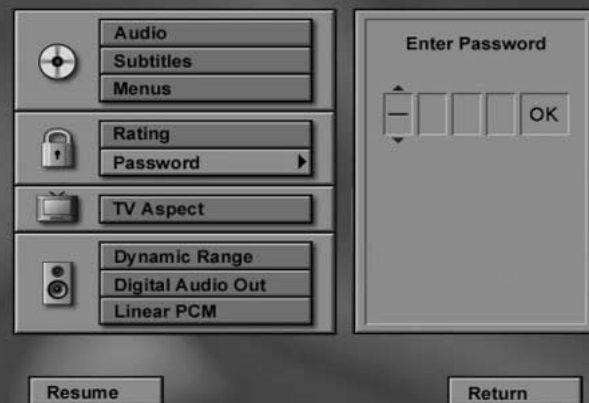

- Press Cursor up/down (▲/▼) keys or numeric keys on the remote to enter password.

- Press ENTER key to finish password input (Confirm Password display appears below Enter Password display).

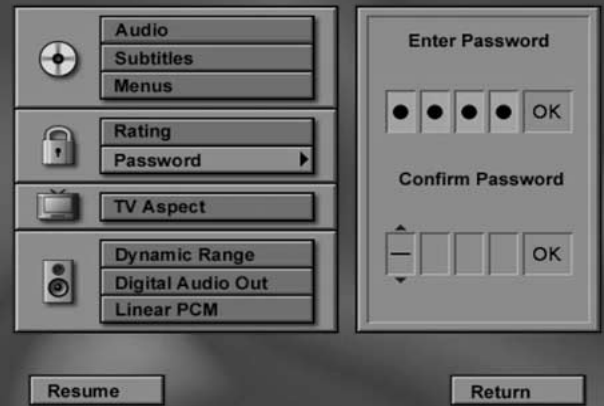

- Press Cursor up/down (▲/▼) keys or numeric keys on the remote to enter again password that you entered.

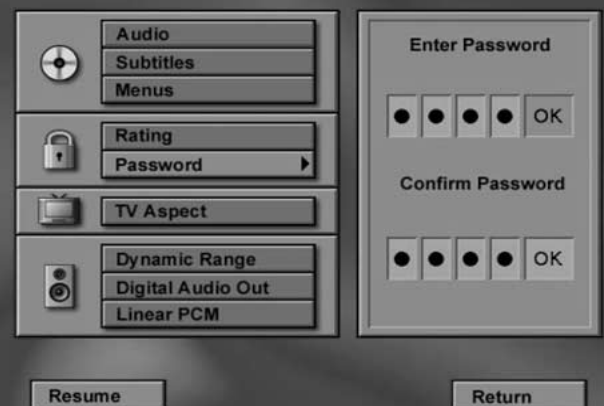

- Press the ENTER key on "OK" icon.



- Press ►/|| key to resume normal playback.

DVD Password (continued)

Change password

- Press Cursor up/down (▲/▼) keys on the remote to select "Password" on the set up menu display, then press the ENTER key.

DV-603/DVF-3060

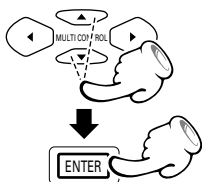

DVF-3060K

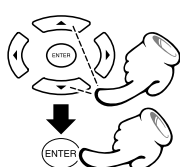

(Enter Password menu appears.)

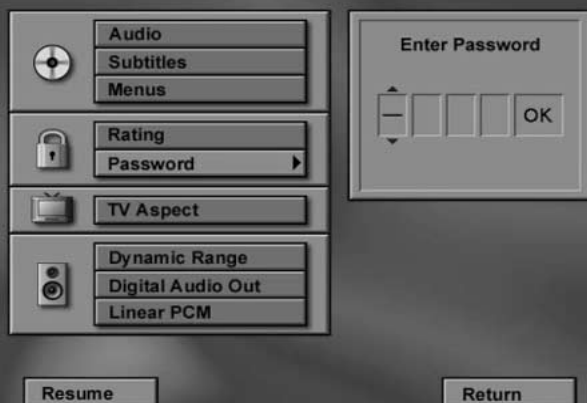

- Press Cursor up/down (▲/▼) keys or numeric keys on the remote to enter password.

DV-603/DVF-3060

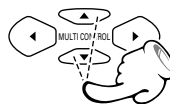

DVF-3060K



- Press ENTER key to finish password input (Confirm Password display appears below Enter Password display).

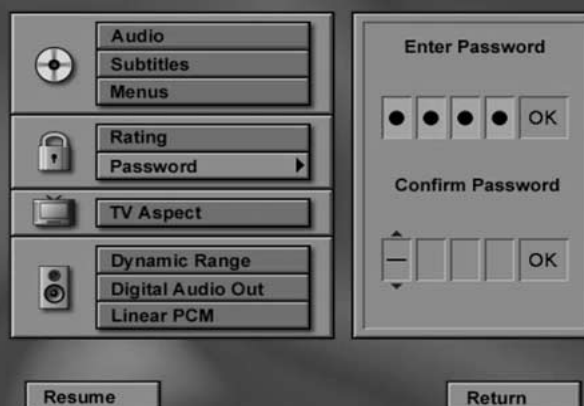

- Press Cursor up/down (▲/▼) keys or numeric keys on the remote to enter again password that you entered.

DV-603/DVF-3060

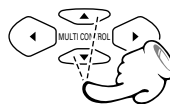

DVF-3060K

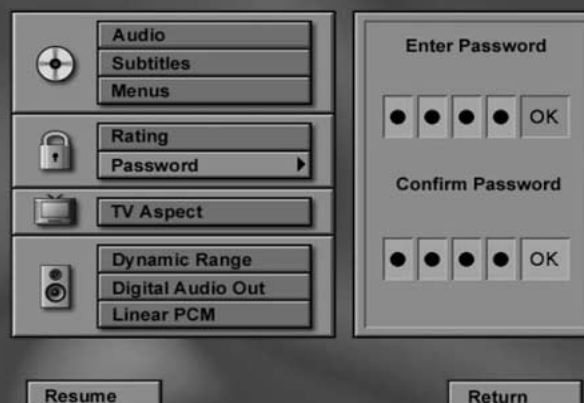

- Press the ENTER key on "OK" icon.

DV-603/DVF-3060



DVF-3060K



- Press ►/|| key to resume normal playback.

- Press Cursor up/down (▲/▼) keys or numeric keys on the remote to enter password. Press the ENTER key on "OK" icon.

DV-603/DVF-3060

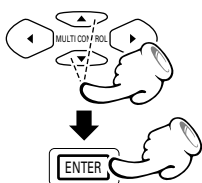

DVF-3060K

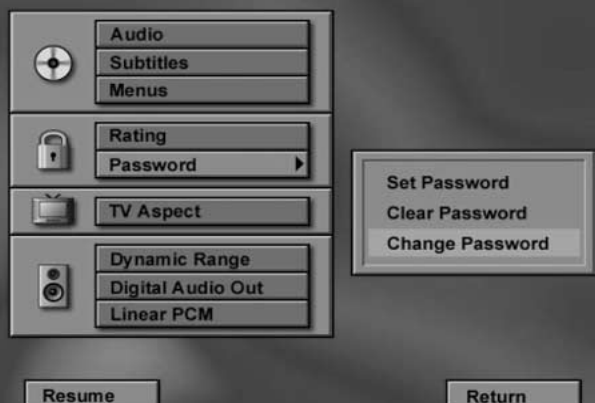
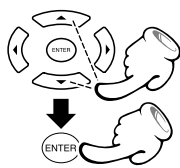

- Press Cursor up/down (▲/▼) keys to select "Change Password", then press ENTER key.

DVD Password (continued)

Clear password

- 1 Press Cursor up/down (▲/▼) keys on the remote to select "Password" on the set up menu display, then press the ENTER key.

DV-603/DVF-3060

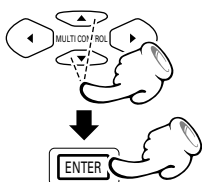

DVF-3060K

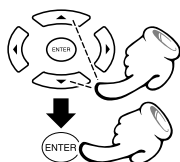

(Enter Password menu appears.)

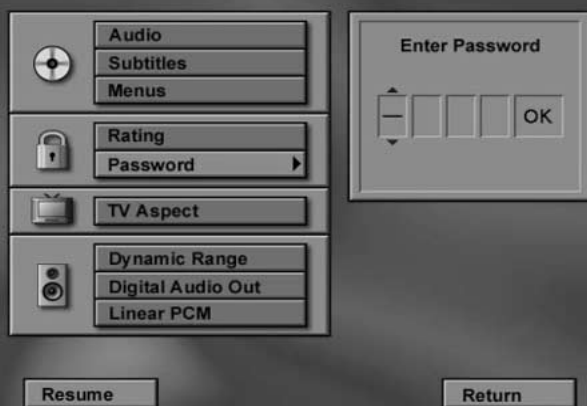

- 2 Press Cursor up/down (▲/▼) keys or numeric keys on the remote to enter password. Press the ENTER key on "OK" icon.

DV-603/DVF-3060

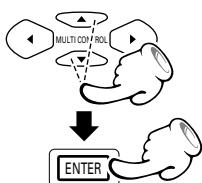

DVF-3060K

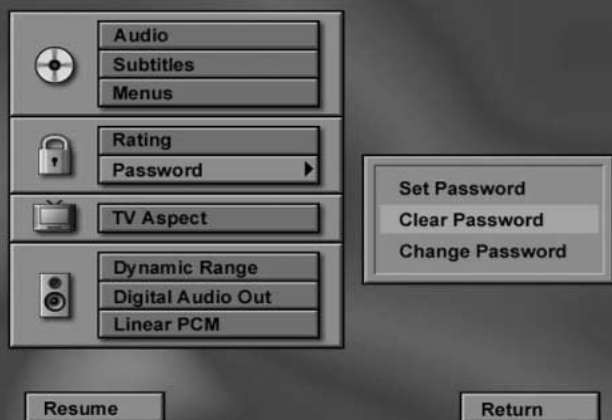
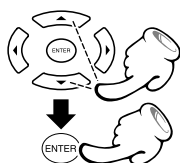

- 3 Press Cursor up/down (▲/▼) keys to select "Clear Password", then press ENTER key.

- Press ►/|| key to resume normal playback.

DVD TV aspect

- 1 Press Cursor up/down (▲/▼) keys on the remote to select "TV Aspect" on the set up menu display, then press the ENTER key.

DV-603/DVF-3060

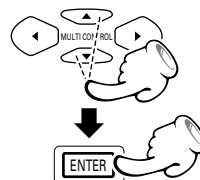

DVF-3060K

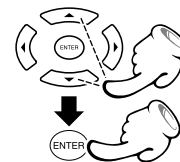

(TV Aspect menu appears.)

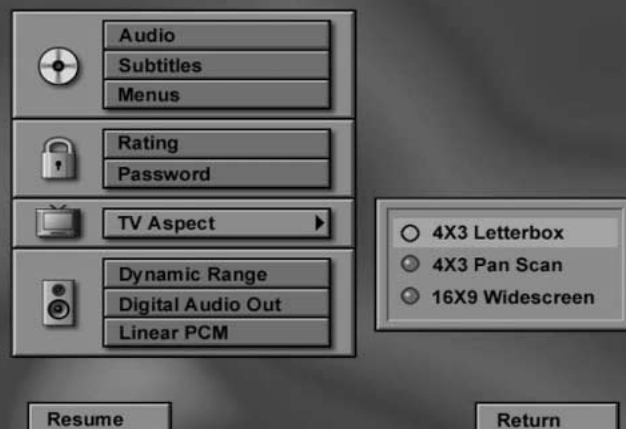

- 2 Press Cursor up/down (▲/▼) keys on the remote to select TV Aspect menu, then press the ENTER key.

DV-603/DVF-3060

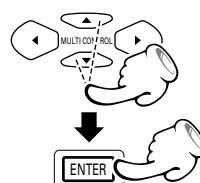

DVF-3060K

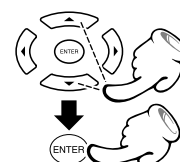

- Press ►/|| key to resume normal playback.

DVD Dynamic Range

- Press Cursor up/down (▲/▼) keys on the remote to select "Dynamic Range" on the set up menu display, then press the ENTER key.

DV-603/DVF-3060

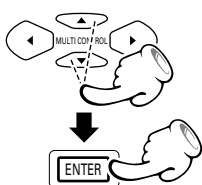

DVF-3060K

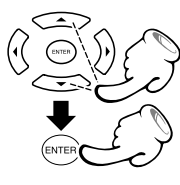

(Dynamic Range menu appears.)

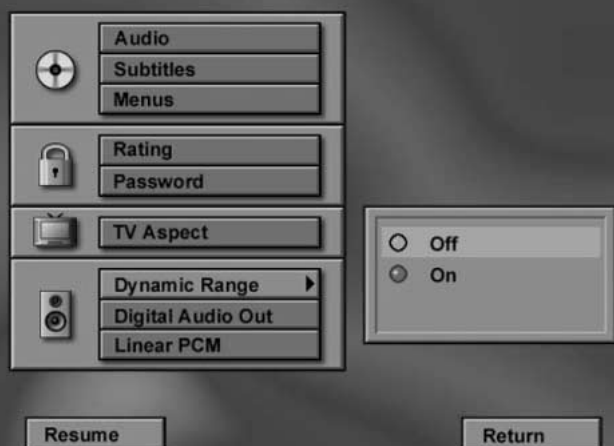

- Press Cursor up/down (▲/▼) keys on the remote to select Dynamic Range mode (on or off), then press the ENTER key.

DV-603/DVF-3060

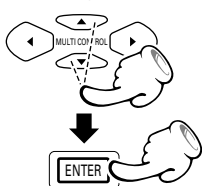

DVF-3060K

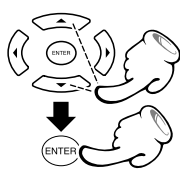

- Press ►/|| key to resume normal playback.

DTS disclaimer clause

When playing DTS-encoded (CDs, LDs, DVDs), excessive noise will be exhibited from the analog stereo outputs. To avoid possible damage to the audio system, the consumer should take proper precautions when the analog stereo outputs of the DVD player is connected to an amplification system. To enjoy DTS Digital Surround™ playback, an external 5.1 channel DTS Digital Surround™ decoder system must be connected to the digital output (S/P DIF, AES/EBU, or TosLink) of the DVD player.

DVD Digital Audio Out

PCM : Choose this setting for all connection scenarios, except the Dolby Digital or DTS receiver or decoder connection.

Dolby Digital : Choose this setting if you connected Dolby Digital receiver or decoder to your DVD player.

DTS : Choose this setting if you connected DTS receiver or decoder to your DVD player

Except for U.S.A. , Canada and U.S. Military

MPEG/DTS : Choose this setting if you connected DTS receiver, decoder or MPEG audio to your DVD player.

- Press Cursor up/down (▲/▼) keys on the remote to select "Digital Audio Out" on the set up menu display, then press the ENTER key.

DV-603/DVF-3060

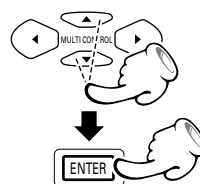

DVF-3060K

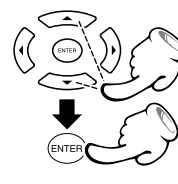

(Digital Audio Out display appears.)

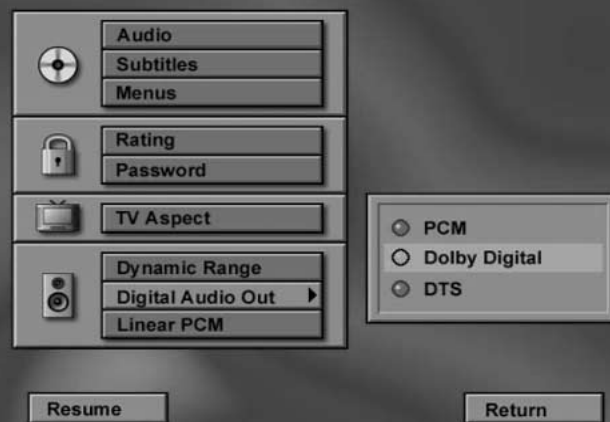

- Press Cursor up/down (▲/▼) keys on the remote to select specific Digital Audio Out mode, then press the ENTER key.

DV-603/DVF-3060

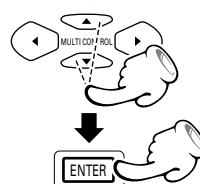

DVF-3060K

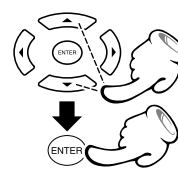

- Press ►/|| key to resume normal playback.



When the DTS of Digital Audio Out or the Dolby Digital setting and the format recorded on the disc are different from each other, audio may not be put out. Please switch according to the indication on the disc.

DVD Linear PCM

96kHz => 48kHz : Even in case of 96 kHz digital signal, DVD will deliver 48 kHz signal out.

96kHz => 96kHz : In case of 96 kHz digital signal, DVD will deliver 96 kHz signal out. In this case your receiver should control 96 kHz signal.

- 1 Press Cursor up/down (▲/▼) keys on the remote to select "Linear PCM" on the set up menu display, then press the ENTER key.

DV-603/DVF-3060

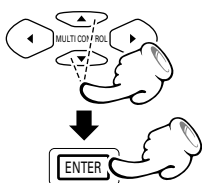

DVF-3060K

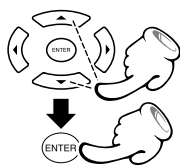

(Linear PCM display appears.)

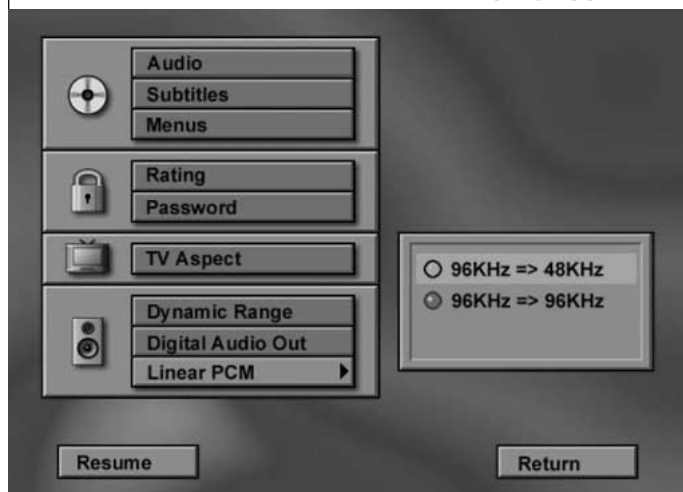

- 2 Press Cursor up/down (▲/▼) keys on the remote to select "96kHz => 48kHz" or "96kHz => 96kHz", then press the ENTER key.

DV-603/DVF-3060

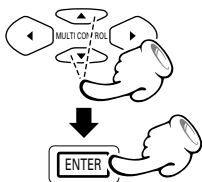

DVF-3060K

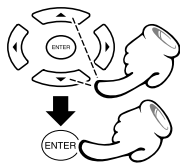

- Press ►/|| key to resume normal playback.

VCD Hierarchical structure of VCD menus

When an item is selected on the menu screen during playback of a P.B.C.-compatible VCD, another menu with more details items may be displayed. When a number of menus are connected in multiple layers in this way, it is said that the menus have a hierarchical structure. In this structure, the desired scene can be reached by repeating item selections on the menu screens.

Example for a hierarchical structure

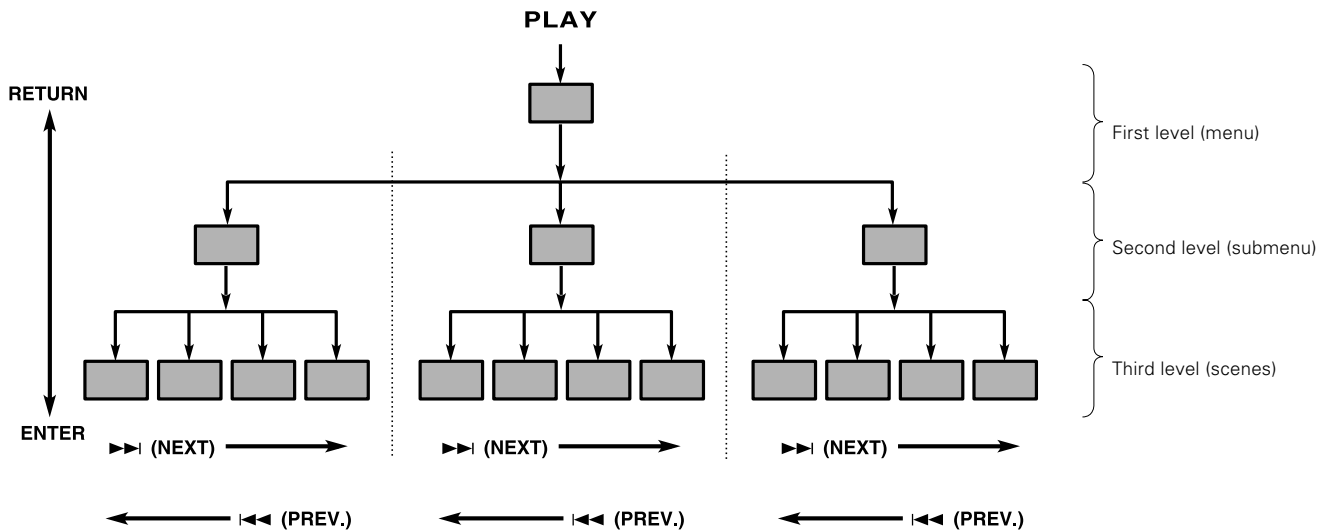

Advancing

When an item is selected on the menu screen with the ENTER (Select) key or the numeric keys, advance is made to the next lower menu level. When the advance destination is the "scene" to be played, the contents will be played.

- When several menus (scenes) can be selected in each level, screen switching is possible with the keys ►► (NEXT) and ◀◀ (PREV.).

Returning

Each time the RETURN key is pressed, return is made to the next higher menu.

Examples of operation keys and indications used during VCD playback

Soft jacket indication	►	◌●	◀◀	►►	► (Select)
KENWOOD operation key	►/	RETURN	◀◀	►►	ENTER

- Depending on the software, the jacket indication may differ from the above.

VCD Playback without using the menu playback function
(In case of a P.B.C.-compatible VCD) (To P.B.C. On or Off)

During VCD playback, press the **TOP MENU** key on the remote control unit.

DV-603/DVF-3060

DVF-3060K

TOP MENU



TOP MENU



- For the track numbers, refer to the disc jacket or other material.
- P.B.C. off mode : Without using menu playback function.

P.B.C. off mode

Goes off

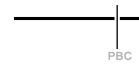

To return to menu playback

Press the **TOP MENU** key again.

P.B.C. on mode

Lit

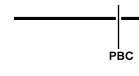

VCD Selecting the Audio channel

You can choose to play back only the right or the left channel of audio recorded on the disc, or you can select stereo playback. This function is used for purposes such as selecting the vocal track on a Karaoke disc.

During VCD playback, press **AUDIO** key on the remote.

DV-603/DVF-3060

DVF-3060K

AUDIO



AUDIO



Each press the key switches the mode.

- ① Stereo
- ② Left
- ③ Right

Preparation

1 Load a disc and Connect a microphone.

① Open the tray.



② Place a disc.

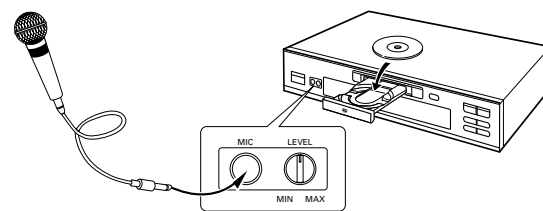

- Adjust volume level of the microphone.



- Karaoke mode operation is possible only when a microphone is connected.
- When this unit is connected with an amplifier or receiver with only the digital connection, the microphone audio cannot be output. Use the **AUDIO OUTPUT** jacks to output the microphone audio from this unit.

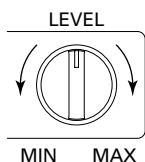

- When the ►/|| key is pressed while a tray is open, the tray closes automatically, and then playback begins.

VCD Selecting the Audio channel

You can choose to play back only the right or the left channel of audio recorded on the disc, or you can select stereo playback. This function is used for purposes such as selecting the vocal track on a Karaoke disc.

During VCD playback, press **AUDIO** key on the remote.



Each press key switches the mode.

- Stereo
- Left
- Right

DVD CD VCD Controlling the key of the music (KEY CONTROL)

This feature allows to transpose the key of the music according to the key of the singer's voice.

1 Press the Key Control key during playback to display the karaoke OSD on the TV screen.

Press within 5 seconds after pressing the **SHIFT** key.

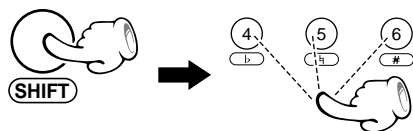

2 Press the cursor up/down (▲/▼) or Key Control keys to adjust the level of the key.

Press within 5 seconds after pressing the **SHIFT** key.

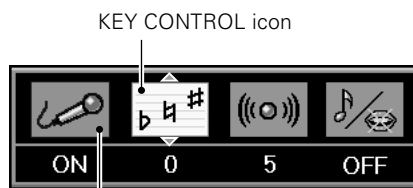
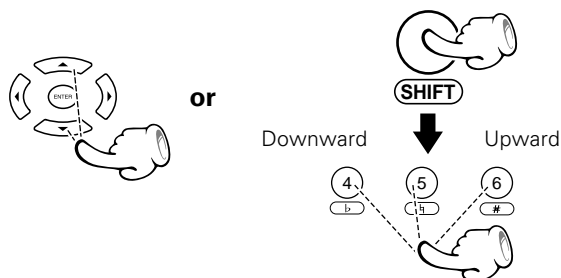

KARAOKE mode icon

- Press the next key within 5 seconds of pressing the **SHIFT** key.

- KEY CONTROL can be varied from -3 to +3.
- Press the Cursor left or right (◀▶) key while the OSD is displayed to select another icon.
- To turn off the OSD, press the **ON SCREEN** key or **CLEAR** key.
- To exit from the KARAOKE mode, select the KARAOKE mode icon while the OSD is displayed and press the **ENTER** key.

DVD CD VCD Adjust the ECHO level

1 Press the ECHO key during playback to display the karaoke OSD on the TV screen.

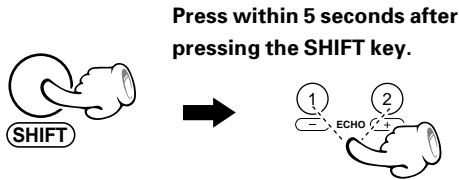

2 Press the cursor up/down (▲/▼) or Key Control keys to adjust the level of echo.

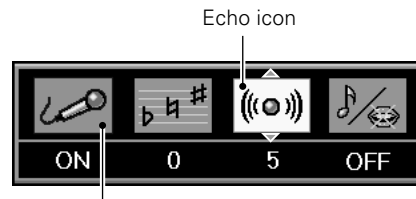
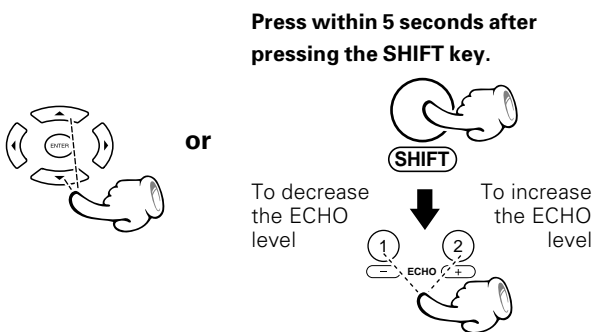

KARAOKE mode icon

- Press the next key within 5 seconds of pressing the **SHIFT** key.

- The echo effect can be varied from 0 to 9.
- Press the Cursor left or right (◀/▶) key while the OSD is displayed to select another icon.
- To turn off the OSD, press the **ON SCREEN** key or **CLEAR** key.
- To exit from the KARAOKE mode, select the KARAOKE mode icon while the OSD is displayed and press the **ENTER** key.



An echo effect can be applied to the microphone voice to make karaoke singing sound better.

DVD CD VCD HIT MASTER function

The sound level of the vocal part of the disc is suppressed, so that it can be used in the same way as a KARAOKE disc.

1 Press the HIT MASTER key during playback to display the karaoke OSD on the TV screen.



2 Press the ENTER or HIT MASTER key to switch it ON/OFF.

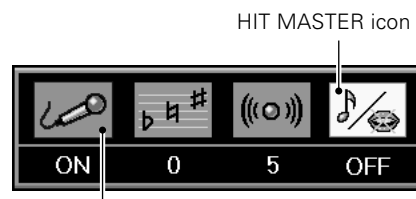
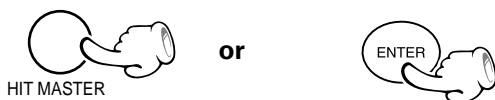

KARAOKE mode icon

Each press the key switches the mode.

- ① HIT MASTER ON
- ② HIT MASTER OFF

- Press the Cursor left or right (◀/▶) key while the OSD is displayed to select another icon.
- To turn off the OSD, press the **ON SCREEN** key or **CLEAR** key.
- To exit from the KARAOKE mode, select the KARAOKE mode icon while the OSD is displayed and press the **ENTER** key.



Depending on the disc, the suppression amount may be smaller.

Guidance of MP3

MP3 media that can be played back with this equipment

Usable media : CD-ROM, CD-R, CD-RW

Usable formats : ISO9660 level 1 (excluding expanded formats)

Files that can be played back : MP3 files

Creating media for playing back on this equipment

Compressing MP3

Please set up the transfer bit rate setting for the compression software when compressing MP3 files as follow.

MP3 Files : 128kbps recommended (32kbps-320kbps)

- This unit is compatible with 32 kHz, 44.1 kHz(recommended) and 48 kHz sampling frequencies.

Naming folders and files

Single-byte characters between A and Z, single-byte numerals between 0 and 9, and the single-byte underscore(_) can be displayed. ensure that the "MP3" (MP3 files) extension log is attached to all file names.

- **Never add the MP3 extension log to any files other than MP3 files. If the MP3 extension log is added to any files other than MP3 files, the equipment will assume that they can be played back, and this will produce loud noises in the speakers, resulting in damage of adverse effects.**

Confirming media and files

Check to ascertain that MP3 files can be played back correctly on the personal computer in use prior to saving them onto the media. Check to ensure that the saved file can be played back normally.

- It is not possible to confirm that files can be played back correctly while they are being saved onto the media.

When saving files onto media

Ensure that the session is closed or finalized when data has been written on media. There are cases where media on which the session has not be closed or finalized will not be played back correctly with this equipment.

- There are cases were the folder names and file names will not be displayed correctly depending on the software used to save them.
- Do not store files or folders other than MP3 on media to be played back with this equipment.
- It is recommended that ten or less sessions are stored when recording MP3 files onto a media.
- Some time may be required until the playback of multi-session discs starts.
- There are cases where playback is not possible when MP3 files (CD-ROM) and music CD infomation (CD-DA) are saved on the same media.

Example for a hierarchical structure

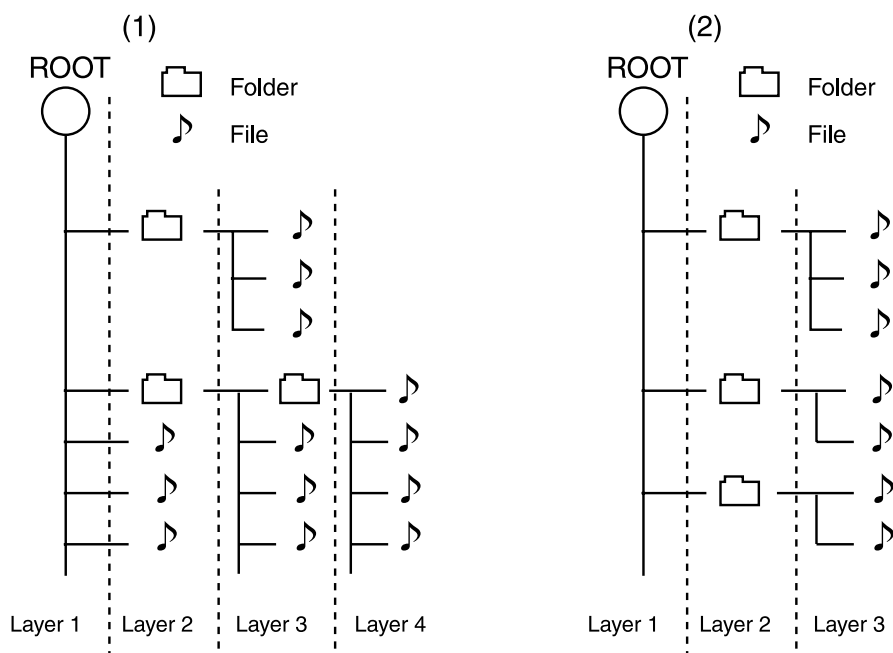

Playing back MP3

- It is not possible to play back folders and files (up to 223) that exceed the maximum limitations of the media.
- A certain amount of time is required for the player to confirm the media on which MP3 files have been recorded before playback will commence.
- The files will be played back in the sequence in which they were recorded (written).

Playback

Each press pauses and plays the disc alternately. (When you insert the MP3 media, playback will start automatically.)

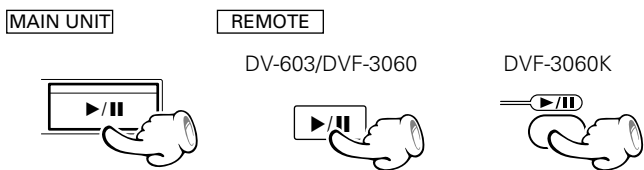

(When you insert MP3 media, the MP3 On-screen display appears.)



To stop playback

Press the ■ (STOP) key.

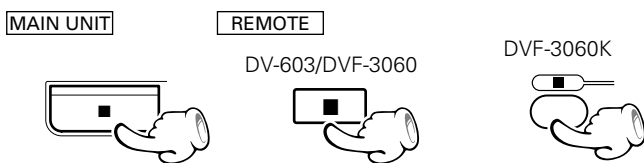

Skipping files

During playback, press the ◀◀ or ▶▶ key.

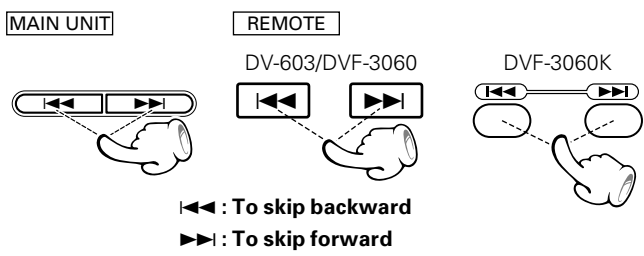

Note Fast forwarding and fast reversing is not possible with MP3 files.

MP3 On-screen display

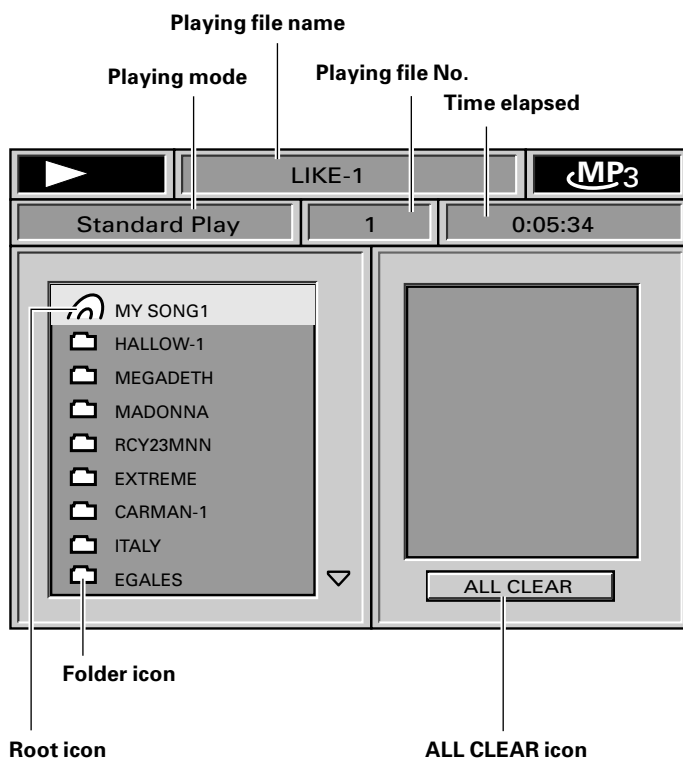

Folder names and file names are displayed up to 8 characters. When folder names and file names are recorded with more than 8 characters, the names will be displayed in abbreviated form.

Selecting MP3 files

- Press Cursor up/down (▲/▼) keys on the remote to select the folder, then press the ENTER key.

DV-603/DVF-3060

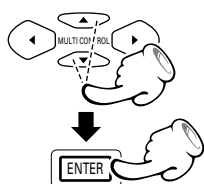

DVF-3060K

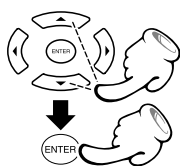

- Press Cursor up/down (▲/▼) keys on the remote to select the file, then press the ENTER key.

DV-603/DVF-3060

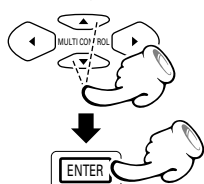

DVF-3060K

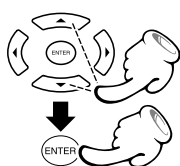

- Playback will start from selected file.

- The files and folders in the selected folder appear.



- Press ENTER key on RETURN folder icon to move to the upper layer.

Selects the files to be played back directly

- Press the Cursor right (▶) key on the remote to invert the file numbers.

DV-603/DVF-3060



DVF-3060K



- Press the numeric keys on the remote to enter the desired file number.

DV-603/DVF-3060

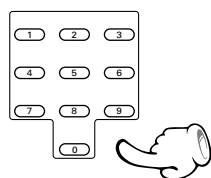

DVF-3060K

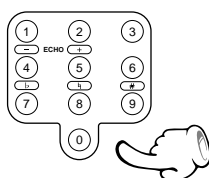

- If "___" is displayed after completion of the file number entry, press the ENTER key before "___" disappears.
- Playback will start from selected file.

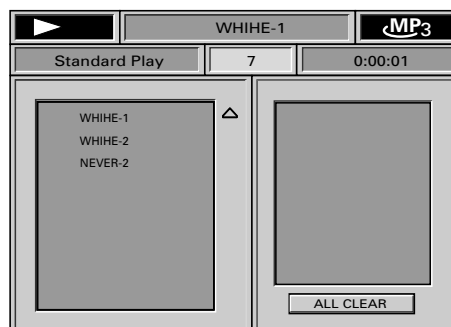

MP3 Repeat play

Desired folders or discs can be played back repeatedly.

- "Repeat 1 Disc" : Repeat the disc that is playing.
- "Repeat 1 Folder" : Repeat the folder that is playing.
- "Repeat Track" : Repeat the file that is playing.

During playback, press the REPEAT key on the remote.

DV-603/DVF-3060



DVF-3060K



- To cancel repeat playback, press the REPEAT key and select "Standard Play".



When the folder played by repeat play contains subfolders, the files in the subfolders cannot be played back.

Each press the key switches the REPEAT mode

- ① "Repeat 1 Disc" : Display lit "REPEAT ALL"
- ② "Repeat 1 Folder" : Display lit "REPEAT ALL"
- ③ "Repeat Track" : Display lit "REPEAT 1"
- ④ "Standard Play"

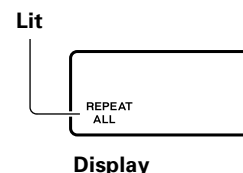
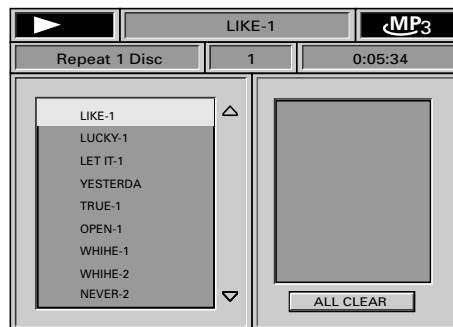

MP3 Random play

The files of the disc are played in random order.

During playback or stop mode, press RANDOM key on the remote.

DV-603/DVF-3060



DVF-3060K



- When the RANDOM key is pressed during playback, the tracks of the disc being played will be selected in random order for playback.
- After all tracks of a disc have been played in random order, playback will stop. (Random mode will be cancelled.)

Each time you press RANDOM key on the remote, random play would be on and off

- ① "Random Play"
- ② "Standard Play"

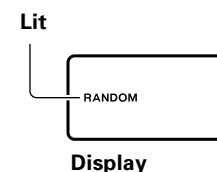
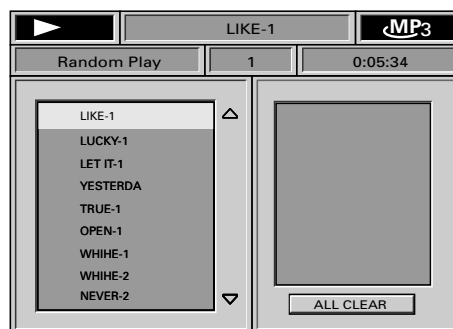

To repeat random play

During random playback, press the REPEAT key on the remote.

DV-603/DVF-3060



DVF-3060K



Each press the key switches the mode.

- ① Display lit "REPEAT ALL"
- ② Repeat canceled



It is not possible to perform random play by specifying a folder name.

MP3 program playback

You can listen to the desired files of the current MP3 disc in any desired order.

Program Edit

- 1 During stop mode, press the **P.MODE** key on the remote.

DV-603/DVF-3060



DVF-3060K



- 2 Press **Cursor up/down (▲/▼)** keys on the remote to select the file, then press the **ENTER** key.

DV-603/DVF-3060

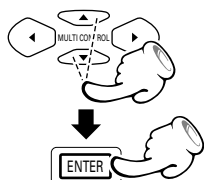

DVF-3060K

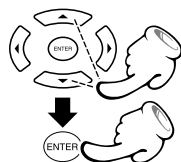

- The selected file goes to the program window.
- You can select a maximum of about 100 files by repeating step 2. However, note that the maximum number of programmable files depends on the number of files and folders in the MP3 disc and on the total number of characters used in the file and folder names.

- 3 Press **▶/||** key to start program playback.

- To return to standard play, press the **P.MODE** key again.
- If a file number is entered during editing or playing a MP3 program, the program mode will be canceled.

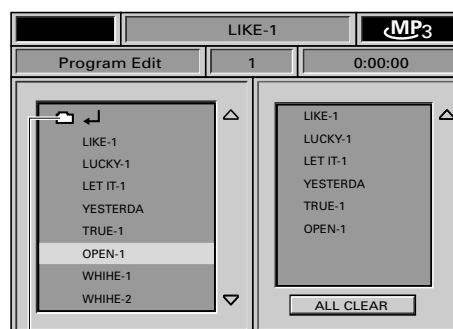
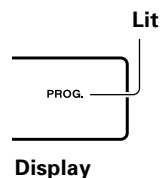

Press **ENTER** key on **RETURN** folder icon to move to the upper layer.



Program repeat play is not available with MP3 discs.

Delete Program

During stop mode, press **Cursor left/right (◀/▶)** keys on the remote to select the **"ALL CLEAR"** icon, then press the **ENTER** key.

DV-603/DVF-3060

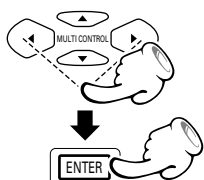

DVF-3060K

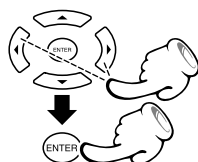

- The program deletes.
- You can delete file one by one by selecting in Program window and pressing **CLEAR** key on the remote.



Cord No.	Language
6565	Afar
6566	Abkhazian
6570	Afrikaans
6577	Amharic
6582	Arabic
6583	Assamese
6588	Aymara
6590	Azerbaijani
6665	Bashkir
6669	Byelorussian
6671	Bulgarian
6672	Bihari
6678	Bengali; Bangla
6679	Tibetan
6682	Breton
6765	Catalan
6779	Corsican
6783	Czech
6789	Welsh
6865	Danish
6869	German
6890	Bhutani
6976	Greek
6978	English
6979	Esperanto
6983	Spanish
6984	Estonian
6985	Basque
7065	Persian
7073	Finnish
7074	Fiji
7079	Faroese
7082	French
7089	Frisian
7165	Irish
7168	Scots Gaelic
7176	Galician
7178	Guarani
7185	Gujarati
7265	Hausa
7273	Hindi

Cord No.	Language
7282	Croatian
7285	Hungarian
7289	Armenian
7365	Interlingua
7378	Indonesian
7383	Icelandic
7384	Italian
7387	Hebrew
7465	Japanese
7473	Yiddish
7487	Javanese
7565	Geogian
7575	Kazakh
7576	Greenlandic
7577	Cambodian
7578	Kannada
7579	Korean
7583	Kashmiri
7585	Kurdish
7589	Kirghiz
7665	Latin
7678	Lingala
7679	Laothian
7684	Lithuanian
7686	Latvian; Lettish
7771	Malagasy
7773	Maori
7775	Macedonian
7776	Malayalam
7778	Mongolian
7779	Moldavian
7782	Marathi
7783	Malay
7784	Maltese
7789	Burmese
7865	Nauru
7869	Nepali
7876	Dutch
7879	Nowegian
7982	Oriya
8065	Punjabi

Cord No.	Language
8076	Polish
8083	Pashto; Pushto
8084	Portuguese
8185	Quechua
8277	Rhaeto-Romance
8279	Romanian
8285	Russian
8365	Sanskrit
8368	Sindhi
8372	Serbo-Croatian
8373	Singhalese
8375	Slovak
8376	Slovenian
8377	Samoan
8378	Shona
8379	Somali
8381	Albanian
8382	Serbian
8385	Sundanese
8386	Swedish
8387	Swahili
8465	Tamil
8469	Telugu
8471	Tajik
8472	Thai
8473	Tigrinya
8475	Turkmen
8476	Tagalog
8479	Tonga
8482	Turkish
8484	Tatar
8487	Twi
8575	Ukrainian
8582	Urdu
8590	Uzbek
8673	Vietnamese
8679	Volapük
8779	Wolof
8872	Xhosa
8979	Yoruda
9072	Chinese
9085	Zulu

What appears to be a malfunction may not always be serious. If your unit should not perform as expected, consult the table below to see if the problem can be corrected before seeking help from your dealer or service representative.

Operation to reset

The microprocessor may fall into malfunction (impossibility to operate erroneous display, etc.) when the power cord is unplugged while power is ON or due to an external factor. In this case, execute the following procedure to reset the microprocessor and return it to normal condition.

- Please note that resetting the microprocessor clears the contents stored in, it returns the microprocessor to the condition when it left the factory.

- In Power ON condition, keep the ■ (Stop) key and the ►► (Search) key pressed at the same time.
- When both keys are pressed, the region code of the unit, the software version, etc. will be displayed on the display. (When nothing is done, the display of this information continues.)
Example: 72. 14.02:05
- Press the **POWER ON/OFF** switch to go to Power OFF.
- When Power ON is performed with the **POWER ON/OFF** switch, the settings become the default factory settings.

DVD player unit

Symptom	Cause	Remedy
Playback does not start when the ►/ key is pressed.	<ul style="list-style-type: none"> There is no disc in the player. There are no signals recorded on the side of the disc being played. 	<ul style="list-style-type: none"> Load a disc and press the ►/ key. Turn the disc over and properly place it on the disc tray.
Playback starts but no image/sound is seen/heard.	<ul style="list-style-type: none"> The TV is not turned on. The connection cords are not properly connected. 	<ul style="list-style-type: none"> Turn on the TV. Properly reconnect the connection cords.
The picture is disrupted when the image is fast forwarded or fast reversed.	<ul style="list-style-type: none"> The picture is slightly disrupted during fast forward and fast reverse operations. 	<ul style="list-style-type: none"> This is not a malfunction.
No sound is heard.	<ul style="list-style-type: none"> The audio output cords are not properly connected. The volume control of the TV or amplifier is not adjusted properly. The player is in a special playback mode. 	<ul style="list-style-type: none"> Properly connect the audio cords. Set the sound volume to an appropriate level. Press the ►/ key to resume normal playback mode.
The picture does not look good or the picture/sound quality is poor.	<ul style="list-style-type: none"> A nearby device is generating noise. The disc is dirty. The disc is damaged. There is condensation on the optical lens. 	<ul style="list-style-type: none"> Separate this unit as far as possible from the device you think is generating the noise. Refer to the "Disc handling precautions" section and wipe dirt from the disc. → 10 Use a new disc. Refer to the "Caution on condensation" section and evaporate the condensation. → 10
It takes a while for the disc to start playing.	<ul style="list-style-type: none"> Time is required for the unit to detect the disc type and size and for the rotation of the motor to stabilize. This is not a malfunction. 	<ul style="list-style-type: none"> Approximately 10 to 20 seconds are required for a disc to start playing, although the time differs depending on the disc.
The tray opens automatically.	<ul style="list-style-type: none"> The disc is not placed horizontally. 	<ul style="list-style-type: none"> Properly place the disc on the tray.
The top and bottom of the screen cannot be seen.	<ul style="list-style-type: none"> The video format of the disc being played does not match that of the connected TV monitor. 	<ul style="list-style-type: none"> Refer to the "Video formats" section, and use a disc with the appropriate video format for your TV or a TV with the appropriate video format for the disc. → 9
The subtitle is not displayed.	<ul style="list-style-type: none"> The DVD disc being played does not contain the recording of subtitles. The subtitle mode is set to off. 	<ul style="list-style-type: none"> The subtitle cannot be displayed when the DVD disc being played does not contain the recording of subtitles. Press the SUBTITLE ON/OFF key to switch on the subtitle mode. → 21
The voice (or subtitle) language cannot be changed.	<ul style="list-style-type: none"> The DVD disc being played does not contain the recording of more than one audio (or subtitle) language. 	<ul style="list-style-type: none"> The voice (or subtitle) language cannot be changed when the DVD disc being played does not contain the recording of more than one voice (or subtitle) language.
The viewing angle cannot be changed.	<ul style="list-style-type: none"> The DVD disc being played does not contain the recording of more than one angle. You are attempting to switch the angle in a DVD section where more than one angle is not recorded. 	<ul style="list-style-type: none"> The viewing angle cannot be changed when the DVD disc being played does not contain the recording of more than one angle. More than one viewing angle may be recorded only in limited sections in a disc.

DVD player unit

Symptom	Cause	Remedy
Playback will not start even after a title is selected.	<ul style="list-style-type: none"> A viewing restriction (RATING) has been set for the disc. 	<ul style="list-style-type: none"> Check the viewing restriction level (RATING) setting.
The viewing restriction level (RATING) cannot be changed.	<ul style="list-style-type: none"> You have forgotten the viewing restriction (RATING) password. 	<ul style="list-style-type: none"> Set the initial setup to the factory setup with the following procedure. <ol style="list-style-type: none"> In POWER ON condition, keep the ■ (Stop) key and the ►► (Search) key pressed at the same time. When both keys are pressed, the region code of the unit, the software version, etc. will be displayed on the display. (When nothing is done, the display of this information continues.) Press the POWER ON/OFF switch to go to Power OFF. When Power ON is performed with the POWER ON/OFF switch, the settings become the default factory settings.
The voice or subtitle language selected in the initial setting is not played.	<ul style="list-style-type: none"> The DVD disc being played does not contain the recording of the selected voice or subtitle language. 	<ul style="list-style-type: none"> Use a DVD disc containing the recording of the selected voice or subtitle language.
No message appears on the TV screen after a key is pressed.	<ul style="list-style-type: none"> The function for displaying message on the TV screen (On-Screen Messages) is set to off. 	<ul style="list-style-type: none"> Set On-Screen Messages to on.
Menu screen messages are not shown in the desired language.	<ul style="list-style-type: none"> The menu language function (MENU) is not set. 	<ul style="list-style-type: none"> Set the disc menu language function (MENU) as required.
A VCD cannot be played using menus.	<ul style="list-style-type: none"> The VCD disc being played is not compatible with P.B.C. 	<ul style="list-style-type: none"> Menu playback is available only with VCD discs recorded with P.B.C.

Remote control unit

Symptom	Cause	Remedy
Remote control operation is not possible.	<ul style="list-style-type: none"> Batteries are exhausted. The remote control is too far away from the system, the controlling angle is deviated or there is an obstacle in between. 	<ul style="list-style-type: none"> Replace with new batteries. Operate the unit inside the remote controllable range.

Inhibition icon

Symptom	Cause	Remedy
 <p>The inhibition icon is displayed and remote control is not possible.</p>	<ul style="list-style-type: none"> Playback is restricted intentionally by the software producer. 	<ul style="list-style-type: none"> The operation is inhibited. Please try another operation.

Apparatus Claims of U.S. Patent Nos. 4,631,603, 4,577,216, 4,819,098 and 4,907,093 licensed for limited viewing uses only.

This product incorporates copyright protection technology that is protected by method claims of certain U.S. patents and other intellectual property rights owned by Macrovision Corporation and other rights owners. Use of this copyright protection technology must be authorized by Macrovision Corporation, and is intended for home and other limited viewing uses only unless otherwise authorized by Macrovision Corporation. Reverse engineering or disassembly is prohibited.

[For U.S.A. and Canada]

Consumers should note that not all high definition television sets are fully compatible with this product and may cause artifacts to be displayed in the picture. In case of 525 progressive scan picture problems, it is recommended that the user switch the connection to the "STANDARD DEFINITION" output. If there are questions regarding our TV set compatibility with this model 525p DVD player, please contact our customer service center.

Manufactured under license from Dolby Laboratories. "Dolby" and the double-D symbol are trademarks of Dolby Laboratories.

"DTS" and "DTS Digital Out" are trademarks of Digital Theater Systems, Inc.



[Type]	[General]
System DVD video player	Power consumption 16 W
Signal read system Semiconductor laser	Dimensions W : 440 mm (17-5/16") H : 75 mm (2-15/16") D : 282 mm (11-1/8")
[D/A Conversion Section]	Weight (net) 3.1 kg (6.8 lb)
D/A conversion 24 Bit	
Oversampling ... 8 fs (Sampling frequency; 44.1, 48 kHz) 4 fs (Sampling frequency; 96 kHz)	
[Audio section]	
Frequency response	
Sampling frequency ; 44.1 kHz 4 Hz ~ 20 kHz	
Sampling frequency ; 48 kHz 4 Hz ~ 22 kHz	
Sampling frequency ; 96 kHz 4 Hz ~ 42 kHz	
Signal to noise ratio More than 98 dB	
Dynamic range More than 95 dB	
Total harmonic distortion Less than 0.005 % (1 kHz)	
Channel separation More than 95 dB (1 kHz)	
Wow and flutter Below measurable limit	
Analog output level/impedance 2 V / 1 k Ω	
Digital output level/impedance	
COAXIAL 0.5 Vp-p / 75 Ω	
OPTICAL -21 dBm ~ -15 dBm (Wave length 660 nm)	
[Video Section]	
Video output format	
(For U.S.A., Canada and U.S. Military) NTSC	
(For other countries) NTSC/PAL	
Video compression	
DVD MPEG-2	
Composite video output level 1 Vp-p (75 Ω load, sync. negative)	
S-video output level	
(Y-signal) 1 Vp-p (75 Ω load, sync. negative)	
(C-signal)	
NTSC 0.286 Vp-p (75 Ω)	
PAL 0.300 Vp-p (75 Ω)	
Horizontal resolution More than 480 lines	
Video signal to noise ratio More than 60 dB	



KENWOOD follows a policy of continuous advancements in development. For this reason specifications may be changed without notice.

- Sufficient performance may not be exhibited at extremely cold locations (Where water freezes).

KENWOOD

For your records

Record the serial number, found on the back of the unit, in the spaces designated on the warranty card, and in the space provided below. Refer to the model and serial numbers whenever you call upon your dealer for information or service on this product.

Model _____ Serial Number _____

Free Manuals Download Website

<http://myh66.com>

<http://usermanuals.us>

<http://www.somanuals.com>

<http://www.4manuals.cc>

<http://www.manual-lib.com>

<http://www.404manual.com>

<http://www.luxmanual.com>

<http://aubethermostatmanual.com>

Golf course search by state

<http://golfingnear.com>

Email search by domain

<http://emailbydomain.com>

Auto manuals search

<http://auto.somanuals.com>

TV manuals search

<http://tv.somanuals.com>