

how to

connect and set up your

KRF-X9992D



DIGITAL AUDIO/VIDEO

Receiver

KENWOOD

Connection and Setup Guide

Connecting and Setting Up Your New Kenwood Audio-Video Receiver

Welcome to the Connection and Setup Guide for your new Kenwood Audio-Video Receiver.

The KRF-X9992D offers two kinds of 5.1-channel digital decoding:

- Dolby® Digital, for the hundreds of currently available Dolby Digital DVDs and LaserDiscs.
- MPEG, a well-established multichannel format in movie theaters, is available for home theater on LaserDisc and DVD.



- ii Manufactured under license from Dolby Laboratories. "Dolby", "Pro Logic", and the double-D symbol are trademarks of Dolby Laboratories. Confidential Unpublished Works. © 1992-1997 Dolby Laboratories. All rights reserved.

Use it to connect all your current audio and video components—the KRF-X9992D has a variety of connection jacks so you can customize your entertainment setup.

KRF-X9992D also provides THX Ultra feature to bring the movie theatre environment into the home.

It also includes Kenwood's remarkable PowerTouch LCD remote—a graphical user interface without having to use your TV!

Other advanced features include 5 S-Video inputs and an optical digital output for digital dubbing to MiniDisc.



©Lucasfilm Ltd. &™. All rights reserved. Used under authorization.

Lucasfilm, THX are registered trademarks of Lucasfilm Ltd.



"DTS" and "DTS Digital Surround" are trademarks of Digital Theater Systems, Inc.

Unpacking

Unpack your new receiver carefully and make sure that all the accessories are present:

PowerTouch Remote



Batteries

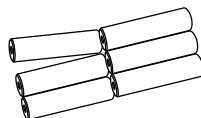

AM Loop Antenna



AM Antenna Base



FM Antenna



If any accessories are missing, or if the receiver is damaged or fails to operate, notify your dealer immediately. If your receiver was shipped to you directly, notify your shipper immediately. Kenwood recommends that you retain the original carton and packing materials in case you need to move or ship the receiver in the future.

Before Applying Power

Read this section carefully to ensure safe operation.

KRF-X9992D is designed for operation as follows.

U.K. and Europe..... AC 230 V only

Factory fitted moulded mains plug

1. The mains plug contains a fuse. For replacement, use only a 13-Amp ASTA-approved (BS1362) fuse.
2. The fuse cover must be refitted when replacing the fuse in the moulded plug.
3. Do not cut off the mains plug from this equipment. If the plug fitted is not suitable for the power points in your home or the cable is too short to reach a power point, then obtain an appropriate safety approved extension lead or adapter, or consult your dealer.

If nonetheless the mains plug is cut off, remove the fuse and dispose of the plug immediately, to avoid a possible shock hazard by inadvertent connection to the mains supply.

IMPORTANT : The wires in the mains lead are coloured in accordance with the following code:

Blue : Neutral

Brown : Live

Do not connect those leads to the earth terminal of a three-pin plug.

iii

Safety Precautions

Read this section carefully to ensure safe operation.

WARNING :

TO PREVENT FIRE OR ELECTRIC SHOCK, DO NOT EXPOSE THIS APPLIANCE TO RAIN OR MOISTURE.





	<p>CAUTION RISK OF ELECTRIC SHOCK DO NOT OPEN</p>		<p>CAUTION: TO REDUCE THE RISK OF ELECTRIC SHOCK, DO NOT REMOVE COVER (OR BACK). NO USER-SERVICEABLE PARTS INSIDE. REFER SERVICING TO QUALIFIED SERVICE PERSONNEL.</p>
	<p>THE LIGHTNING FLASH WITH ARROWHEAD SYMBOL, WITHIN AN EQUILATERAL TRIANGLE, IS INTENDED TO ALERT THE USER TO THE PRESENCE OF UNINSULATED "DANGEROUS VOLTAGE" WITHIN THE PRODUCT'S ENCLOSURE THAT MAY BE OF SUFFICIENT MAGNITUDE TO CONSTITUTE A RISK OF ELECTRIC SHOCK TO PERSONS.</p>		
	<p>THE EXCLAMATION POINT WITHIN AN EQUILATERAL TRIANGLE IS INTENDED TO ALERT THE USER TO THE PRESENCE OF IMPORTANT OPERATING AND MAINTENANCE (SERVICING) INSTRUCTIONS IN THE LITERATURE ACCOMPANYING THE APPLIANCE.</p>		

Table of Contents

Chapter One: Connecting Your Devices 1	To Connect a Kenwood 200-Disc CD Changer:	Connecting Your Laser Disc Player (without AC-3 RF Output) 26
Noting Your Devices 3	To Connect Any Other Primary CD Player or Changer:	To Connect a PCM Digital Output Laser Disc Player:
Connecting Your Speakers 4	To Connect a Secondary CD Player:	Connecting Your Turntable/Record Player 28
To Connect Front Speakers Only:	Connecting Your DVD Player 16	To Connect a Turntable/Record Player:
To Connect Front and Surround Sound Speakers:	To Connect a DVD Player:	Connecting a Camcorder or Additional VCR 29
What if I Have a Powered Subwoofer?	Connecting Your DVD Player Through a Surround Processor 18	To Connect a Camcorder or Additional VCR:
What if I Have an Amplifier?	To Connect a DVD Player Through a Surround Processor:	Can I Connect an Additional VCR Permanently?
Connecting Your TV 8	Connecting Your MD Recorder or Primary Tape Deck 20	What if I Have Several Kenwood Devices (System Control Chaining)? 30
To Connect a TV:	To Connect an MD Recorder:	An Example of SL16 Chained Connections:
What if I Want to Watch TV without Turning on the Receiver?	To Connect a Primary Tape Deck:	An Example of XS8 Chained Connections:
Connecting Your Cable TV or Satellite Tuner 10	To Connect a Secondary Tape Deck:	Connecting the Antennas 31
To Connect a Cable TV Tuner with a Composite (RCA) Video Output:	Connecting Your Secondary CD Player or Tape Deck 22	AM Loop Antenna
To Connect a Cable TV Tuner without a Composite (RCA) Video Output:	To Connect a Secondary CD Player:	FM Indoor Antenna
To Connect a Satellite Tuner:	To Connect a Secondary Tape Deck:	FM Outdoor Antenna
Connecting Your VCR(s) 12	Connecting Your Laser Disc Player (with AC-3 RF Output) 24	What if I Have Cable Radio?
To Connect a Primary VCR:	To Connect an AC-3 RF Output Laser Disc Player:	
To Connect a Secondary VCR:		
Connecting Your Primary CD Player 14		
What if I Have a Video CD-Compatible CD Player?		

Chapter Two: Setting Up PowerTouch... 32

Installing the Batteries 32

Calibrating the Touch Screen 33
Resetting PowerTouch

Navigating PowerTouch Interface 34

Setting Up Speakers 34
SP Selection
SP Distance
SP Level
Bass Peak Level

Identifying Devices For PowerTouch Control 37

- How Do I Identify Devices?
- How Do I Replace a Setup Code with a New One?
- How Do I Delete Setup Codes?
- What if my device does not work with any of the codes on the list?
- What if I Want PowerTouch to Control Additional Functions?

Storing Radio Stations in Memory (optional) 40

- Storing RDS Stations Automatically
- Storing Stations Manually

Chapter Three: Specifications 42

KRF-X9992D Specifications

Chapter One: Connecting Your Devices

Welcome to the Kenwood KRF-X9992D Connection and Setup Guide. This chapter guides you through connecting your home entertainment devices to your new Kenwood audio-video receiver.

Once all your devices are connected, you can set up the PowerTouch (see Chapter Two).

Refer to the following pages for details on connecting these devices:

Speakers	page 4
TV	page 8
VCR(s)	page 12
CD Player, Kenwood 200-Disc Changer	page 14
DVD Player	page 16
MD Recorder	page 20
Tape Deck(s)	page 20
Laser Disc Player	page 24
Turntable	page 28
Camcorder/Second VCR	page 29
Antennas	page 31



All necessary cables should be provided with your home entertainment device (not with your new receiver). If you do not have the correct cables, you may purchase these cables from any home entertainment store.

To make coaxial digital connections, be sure to use a high-quality digital audio cable, not a standard audio cable.

Do not plug in the receiver or any other device to AC power until all connections have been made. Once all devices have been connected, you may plug them in and provide power.

Important:

Your new receiver requires adequate ventilation to perform reliably. Be sure not to block the ventilation area on the top or back (or both sides) of the receiver with another device. These areas should be: at least top; 50cm, back; 10cm, and left and right side; 10cm

Do not install your receiver where direct sunlight or high frequency fluorescent lighting can shine directly into the remote sensor. This can cause your new receiver to malfunction.

Before You Begin

This manual covers the most common and standard connections to the receiver. Because of its versatility, you may decide to connect your devices differently.

Before making any video connections to the your receiver :

- You can use either S-Video or standard composite (RCA) video connections.
- If all of your video devices and TV have S-Video connectors, we suggest that you use them exclusively, since it will provide superior video performance.
- If only some of your video devices and TV have S-Video connectors, you can still use them for those devices and the TV. Use the composite connectors for your devices that don't have S-Video connectors. In this case you'll also have to connect the receiver's composite Video Monitor output to your TV for your non S-Video devices and switch between inputs on TV.
- If your TV doesn't have S-Video connectors, you can't use S-Video connections for any of your video devices. Use the composite connectors exclusively.
- If your TV does not have any video connections at all (it only has antenna connections), you must purchase an RF modulator that converts video signals into antenna signals to use it with the KRF-X9992D. You should be able to find an RF modulator at a store specializing in electronic parts.

The following diagram shows the entire back of the KRF-X9992D.

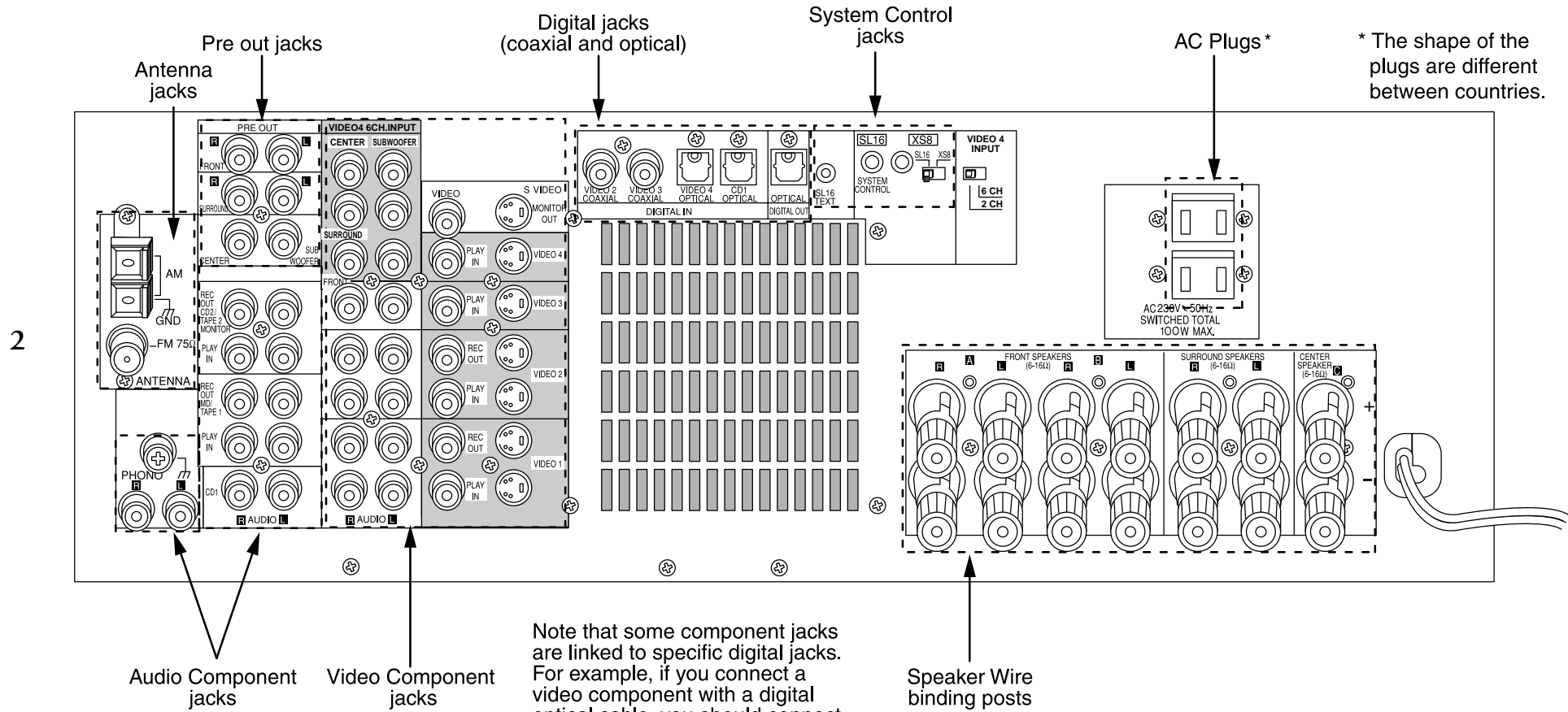

Noting Your Devices

Jack Set	Device	Manufacturer	Model #	Setup Code
Phono				_____
CD1				
MD/Tape1				
CD2/Tape2 Monitor				
Video (TV1 on PowerTouch)				
Video1				
Video2				
Video3				
Video4				

3

Use this table and the diagram on the preceding page to plan your connections before you make them, or use it to record your connections as you make them. If you will be connecting a DVD player or other device with a digital output, please refer to the following chart before choosing a video jack set:

If your digital cable is...	Choose this jack set...
optical	VIDEO4
coaxial	VIDEO2 or 3

You will need this information later, when you set up your PowerTouch (see "Identifying Devices For PowerTouch Control" on page 37). Recording this information now will save you additional trips behind your home entertainment cabinet. You will fill in the Setup Code column when you are setting up PowerTouch.

Connecting Your Speakers

4

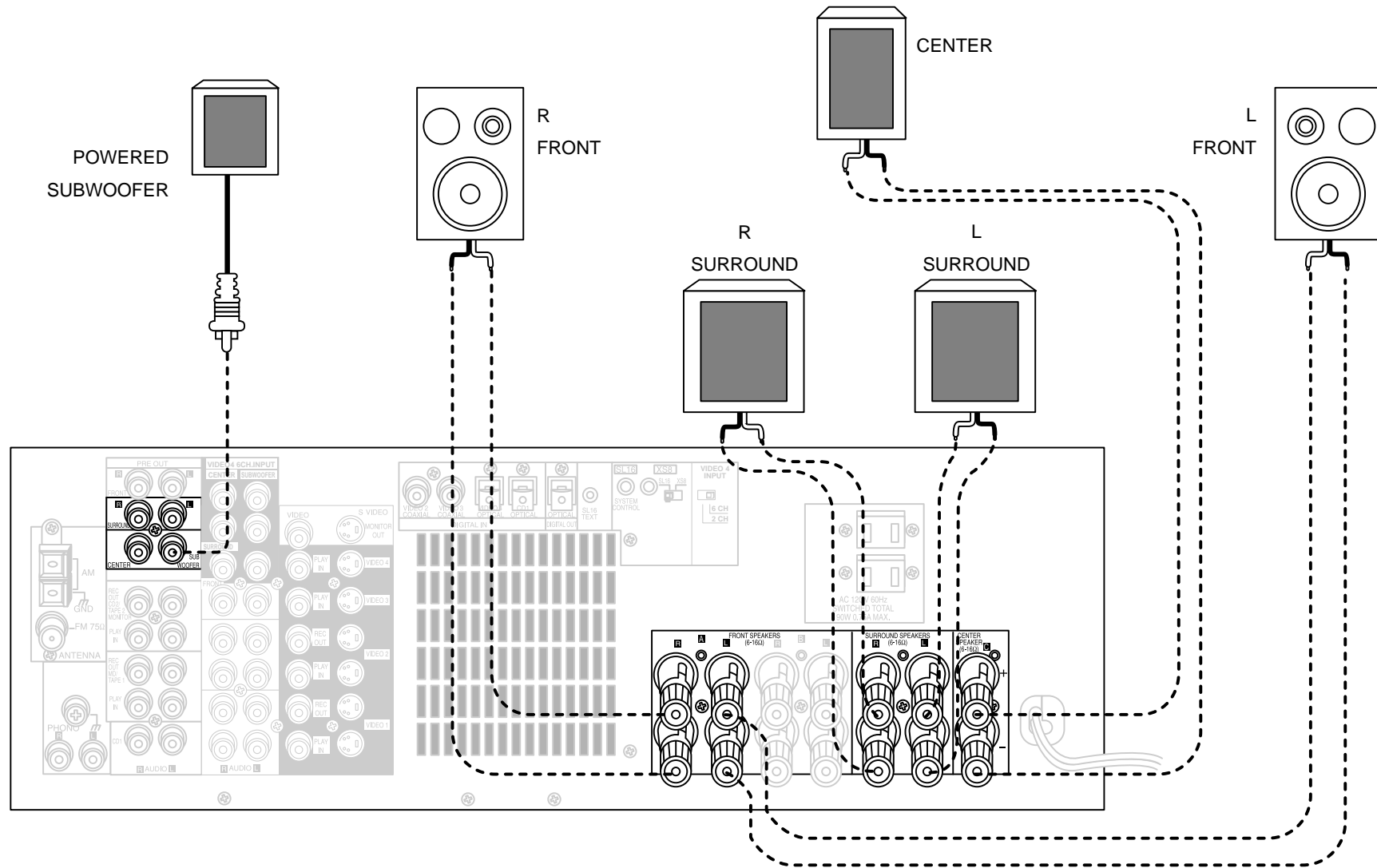

Do not plug in the receiver to AC power until all connections have been made.

To Connect Front Speakers Only:

If you only intend to listen to stereo sound (as opposed to surround sound), you may simply connect a single pair of speakers. To do so:

1. Loosen the speaker wire binding posts.
2. Insert the wire from the positive jack on the RIGHT FRONT speaker into the U-shaped slot in the base of the positive RIGHT FRONT post. Lay the wire to the right of the post; that way, when you tighten the binding post, it will naturally twist the wire into the best connection. Tighten the post. Repeat for the negative wire on the RIGHT FRONT speaker as shown to the right.
3. Repeat step 2 for the positive and negative wires on the LEFT FRONT speaker.

Connecting Your Speakers, continued

To Connect Front and Surround Sound Speakers:

To listen to the full surround sound that this receiver can put out, connect front speakers, center, left surround, and right surround speakers. To do so:

1. Loosen the speaker wire binding posts.
2. Follow the steps under "To Connect Front Speakers Only" on this page to connect the RIGHT and LEFT FRONT speakers.
3. Insert the wire from the positive jack on the CENTER speaker into the U-shaped slot in the base of the positive CENTER post, as shown to the right. Tighten the post. Repeat for the negative wire.
4. Insert the wire from the positive jack on the RIGHT SURROUND speaker into the U-shaped slot on the base of the positive RIGHT SURROUND post. Tighten the post. Repeat for the negative wire.
5. Repeat step 4 for the positive and negative wires on the LEFT SURROUND speaker.

What if I Have a Powered Subwoofer?

Simply connect the subwoofer's audio cable to the receiver's subwoofer PRE OUT jack as shown to the left.



Never short circuit the + and - speaker wires.

Do not switch the left and right speaker wires or swap the + and - wires on the binding posts.

The speakers must have a nominal impedance of between 6Ω and 16Ω.

Using Speaker Wire

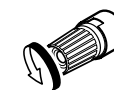

1. Loosen post



2. Insert wire



3. Tighten post

What if I Have an Amplifier?

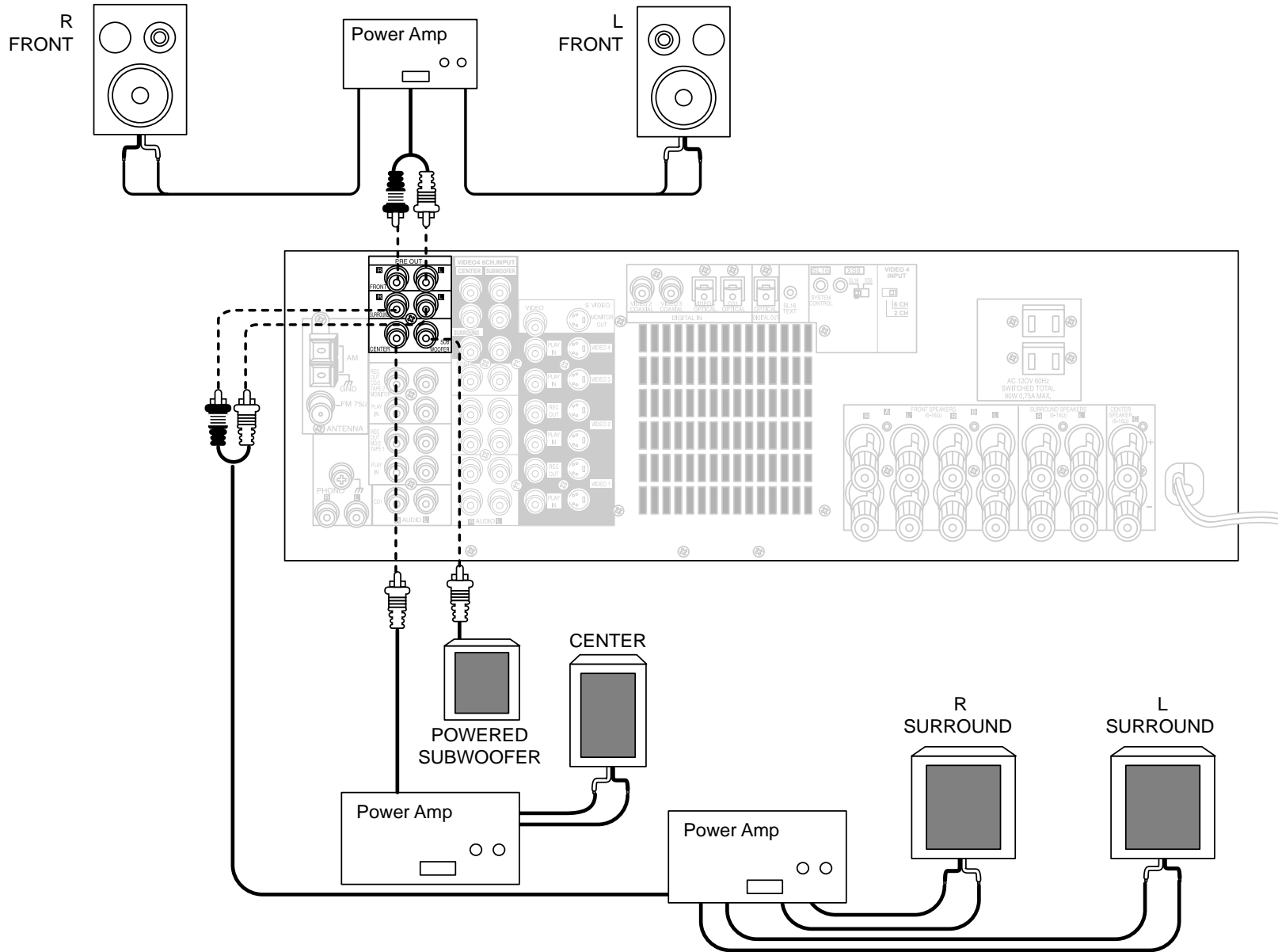

What if I Have an Amplifier?, continued

You can use supplemental power amplifiers for any of the channels instead of the receiver's built-in amplifiers.

Do not plug in the amplifiers or the receiver to AC power until all connections have been made.

To connect supplemental power amplifiers:

1. Using RCA audio cables (not supplied), connect the receiver's PRE OUT jacks to the amplifiers' input jacks as shown to the left.
2. Connect the speakers to the power amplifiers according to the amplifiers' instruction manuals.

Connecting Your TV

8

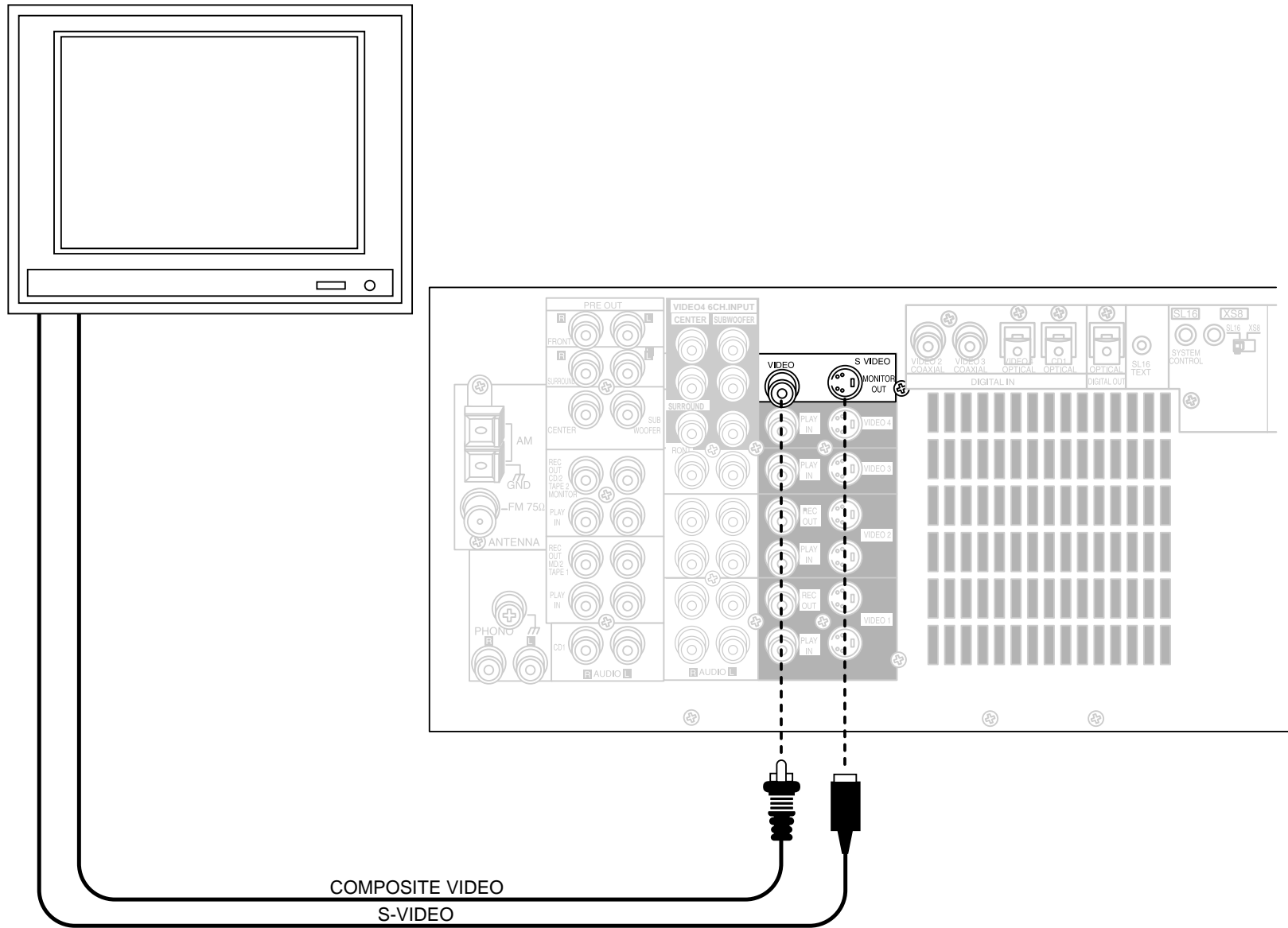



Do not plug in the receiver or devices to AC power until you have connected all your devices.

This section focuses on the connections from your TV to the KRF-X9992D. Please refer to your TV's instructions for more detail about its connection jacks and capabilities.

The instructions in this section show how to connect your TV as a monitor for the other video devices you connect (without using it as an audio/video source device itself). To use your TV as an audio/video source device, you must first connect it as described in this section, and also connect its audio/video output jacks as if they were cable TV tuner outputs, as described in "To Connect a Cable TV Tuner with a Composite (RCA) Video Output" on page 11.

Connecting Your TV, continued

To Connect a TV:

1. Review the information under "Before You Begin" on page 1. It contains important notes about the types of video connections you can make.
2. Connect a video cable from your TV's Video IN jack to the receiver's MONITOR OUT jack as shown to the left.
3. If your TV does not have any video input connections, you must purchase an RF modulator. The modulator will convert the video signal from the receiver to an RF signal that will work with the TV's antenna connections.

Connect the receiver to the TV according to the RF modulator's instruction manual.
4. Go to "Noting Your Devices" on page 3 and note which jack you used to connect your TV. In addition, note the brand name and model number of the TV.

If you previously connected your TV directly to your VCR, you must now connect it through your new receiver.

What if I Want to Watch TV without Turning on the Receiver?

The connection described here sets your TV up as a monitor you can use to view media played on your other video devices (such as a VCR or DVD player). You can still watch TV without having to use the receiver.

Connecting Your Cable TV or Satellite Tuner

Note that video device jacks are linked to specific digital jacks. For example, if you connect a satellite tuner with a digital coaxial cable, you should connect the analog cables to the VIDEO 2 video device jacks and the digital cable to the VIDEO2 digital COAXIAL jack.

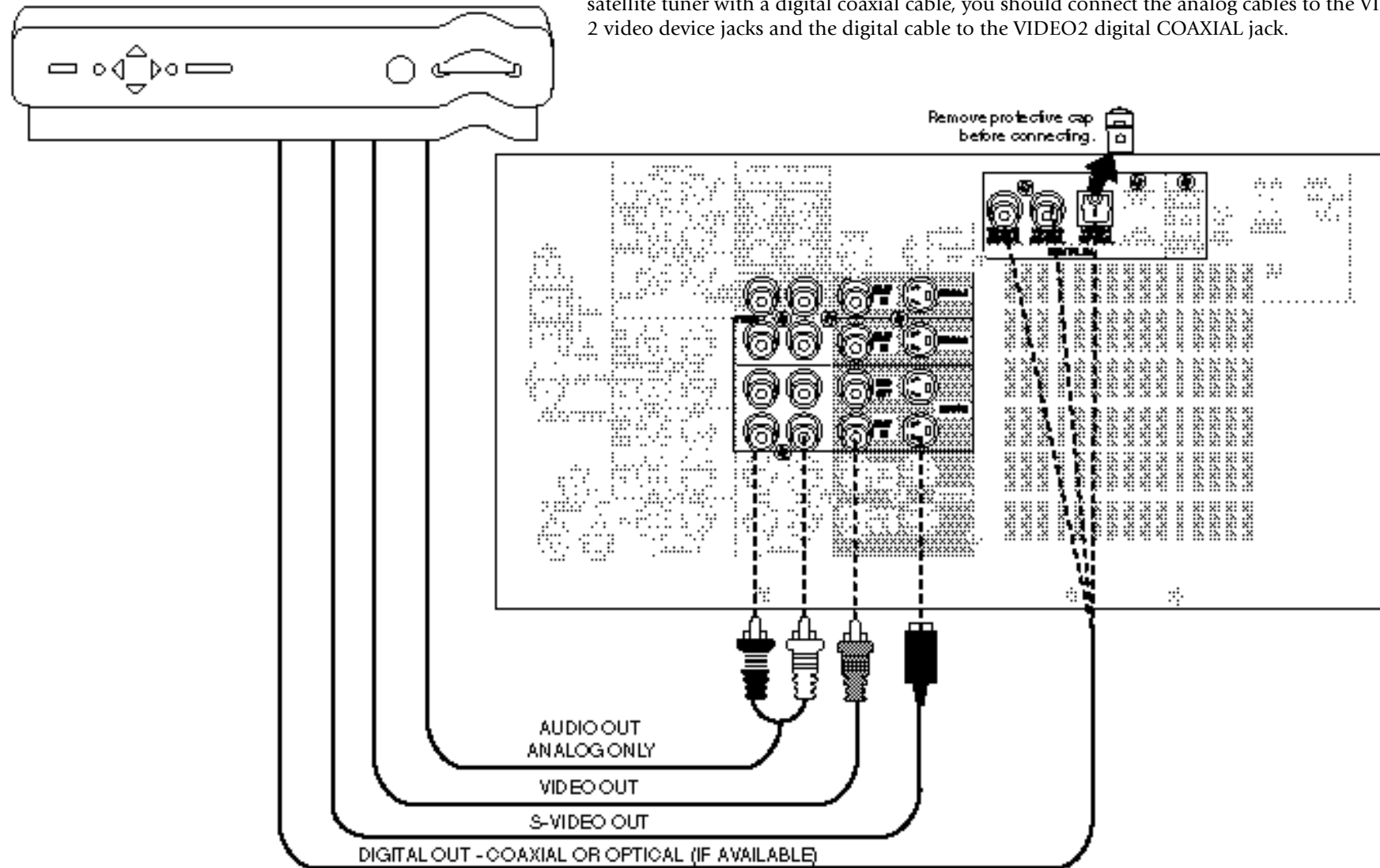

Connecting Your Cable TV or Satellite Tuner, continued



Do not plug in the receiver or devices to AC power until you have connected all your devices.

This section focuses on the connections from your cable or satellite tuner to the KRF-X9992D. Please refer to your tuner's instructions for more detail about its connection jacks and capabilities.

The instructions in this section show one of several possible variations on connecting your tuner. For further assistance on optional configurations, contact your cable or satellite provider.

To Connect a Cable TV Tuner with a Composite (RCA) Video Output:

1. Review the information under "Before You Begin" on page 1. It contains important notes about the types of video connections you can make.
2. Connect the audio and video cables from the cable tuner's Audio and Video Out jacks to the receiver's VIDEO 2, VIDEO 3, or VIDEO 4 PLAY IN jacks as shown to the left.
3. Go to "Noting Your Devices" on page 3 and note which jack you used to connect your tuner. In addition, note the brand name and model number of the tuner.

To Connect a Cable TV Tuner without a Composite (RCA) Video Output:

1. Review the information under "Before You Begin" on page 1. It contains important notes about the types of video connections you can make.
2. Connect the audio cables from the cable tuner's Audio Out jacks to the receiver's VIDEO 2, VIDEO 3, or VIDEO 4 PLAY IN jacks as shown to the left.
3. Leave the cable tuner's video out (RF jack) connected directly to your VCR or TV (wherever you already have it connected). See "How Do I Operate Devices?" on page 26 of the *Users' Guide* for details about using this setup.
4. Go to "Noting Your Devices" on page 3 and note which jack you used to connect your tuner. In addition, note the brand name and model number of the tuner.

To Connect a Satellite Tuner:

1. Review the information under "Before You Begin" on page 1. It contains important notes about the types of video connections you can make.
2. If your satellite receiver has a digital output, use the table below to select a jack set:

If your digital cable is...	Choose this jack set...
optical	VIDEO4
coaxial	VIDEO2 or 3

Note that the jack sets are linked, even though they are not adjacent. You **must** connect all of the cables from your satellite receiver to a linked jack set. For example, if you connect the analog cables to VIDEO2 and the digital optical cable to VIDEO4, your satellite receiver will not work correctly.

3. Connect the audio and video cables from the satellite tuner's Audio and Video Out jacks to the receiver's VIDEO 2, VIDEO 3, or VIDEO 4 PLAY IN jacks as shown to the left.
4. Go to "Noting Your Devices" on page 3 and note which jack you used to connect your tuner. In addition, note the brand name and model number of the tuner.

Connecting Your VCR(s)

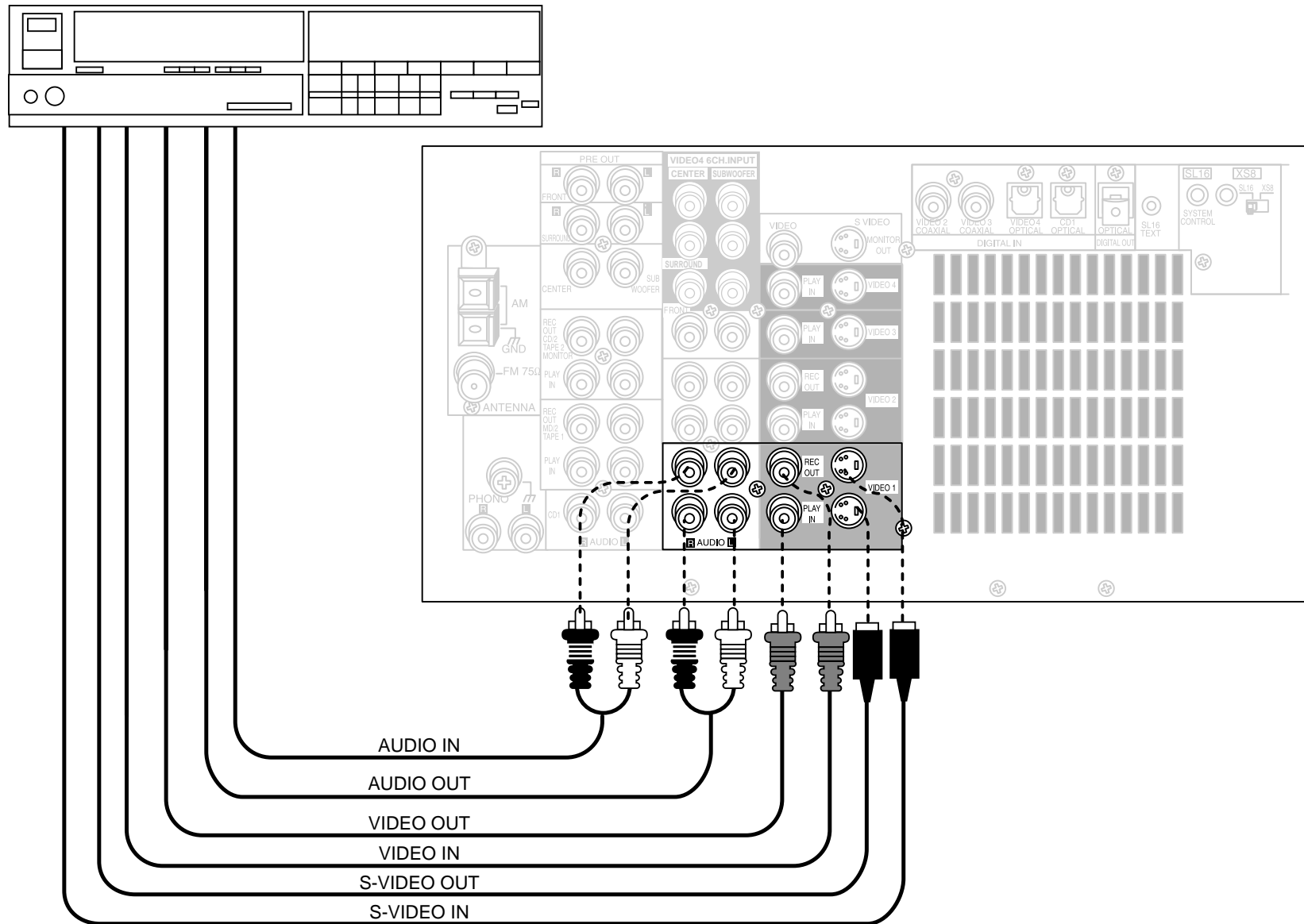



Do not plug in the receiver to AC power until you have connected all your devices.

This section focuses on the connections from your VCR to the KRF-X9992D. Please refer to your VCR's instructions for more detail about its connection jacks and capabilities.

The instructions in this section show one of several possible variations on connecting your VCR. For further assistance on optional configurations, contact the store where you purchased your receiver.

Connecting Your VCR(s), continued

To Connect a Primary VCR:

1. Review the information under "Before You Begin" on page 1. It contains important notes about the types of video connections you can make.
2. Connect the audio and video cables from the VCR's Audio and Video jacks to the receiver's VIDEO 1 REC OUT and PLAY IN jacks as shown to the left.
3. Be sure to connect the VCR Video IN cable to the jack labeled REC OUT and the VIDEO OUT cable to the jack labeled PLAY IN.
4. Go to "Noting Your Devices" on page 3 and note which jack you used to connect your VCR. In addition, note the brand name and model number of the VCR.

To Connect a Secondary VCR:

1. Review the information under "Before You Begin" on page 1. It contains important notes about the types of video connections you can make.
2. Connect the audio and video cables from the VCR's Audio and Video jacks to the receiver's VIDEO 2 REC OUT and PLAY IN jacks.
3. Be sure to connect the VCR Video IN cable to the jack labeled REC OUT and the VIDEO OUT cable to the jack labeled PLAY IN.
4. Go to "Noting Your Devices" on page 3 and note which jack you used to connect your VCR. In addition, note the brand name and model number of the VCR.

Connecting Your Primary CD Player

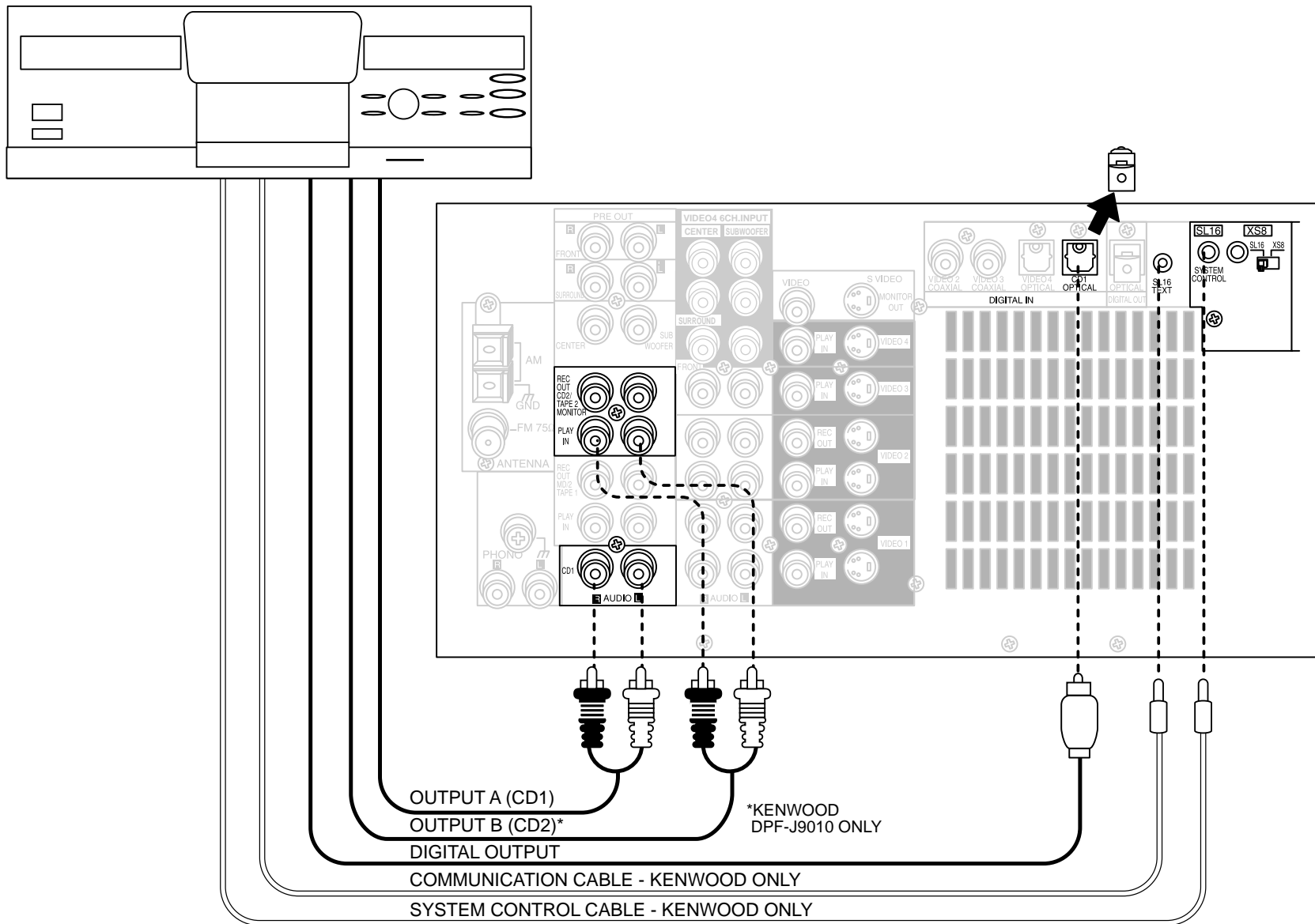

Connecting Your Primary CD Player, continued



Do not plug in the receiver to AC power until you have connected all your devices.

This section focuses on the connections from your 200-Disc CD Changer to the KRF-X9992D. Please refer to your changer's instructions for more detail about its connection jacks and capabilities.

Each set of instructions in this section shows one of several possible variations on connecting your CD player(s). For further assistance on optional configurations, contact the store where you purchased your CD player(s).

The illustration shows a Kenwood 200-Disc CD Changer. Your CD player may look different.

Kenwood DPF-J9010 contains two CD transports. You must connect it as though they were two CD players.

What if I Have a Video CD-Compatible CD Player?

Connect the audio and video cables from the CD player to any unused Video jack set.

Do not connect the system control cable in this instance.

To Connect a Kenwood 200-Disc CD Changer:

1. Connect the audio cables from the 200-Disc Changer to the receiver's CD1 jacks.
If you have a Kenwood DPF-J9010, connect Output A to the receiver's CD1 jacks and Output B to the receiver's CD2/Tape2 Monitor PLAY IN jacks as shown to the left.
2. Connect the optical digital cable from the changer to the receiver's CD1 OPTICAL jack as shown to the left.
3. Connect the system control cable from the changer to the SYSTEM CONTROL jack as shown to the left.

Be sure that the SL16/XS8 switch on both the changer and the receiver is set to SL16.

If you are connecting more than one Kenwood device with a system control cable, see "What if I Have Several Kenwood Devices (System Control Chaining)?" on page 30 for more information.

4. Connect the SL16 text cable (communication cable) from the changer to the receiver's SL16 TEXT jack as shown to the left.
5. Go to "Noting Your Devices" on page 3 and note which jacks you used to connect your CD changer. In addition, note the brand name and model number of the CD Changer.

To Connect Any Other Primary CD Player or Changer:

1. Connect the audio cables from the CD player's audio jacks to the receiver's CD1 jack set as shown to the left.
2. Connect the optical digital cable from the CD player's digital jack to the receiver's CD1 OPTICAL jack as shown to the left.
3. If you are connecting a Kenwood CD Player with system control, connect the system control cable from the CD player to the system control jack as shown to the left.

Be sure that the SL16/XS8 switch on both the player/changer and the receiver is set appropriately.

If you are connecting more than one Kenwood device with a system control cable, see "What if I Have Several Kenwood Devices (System Control Chaining)?" on page 30 for more information.

4. Go to "Noting Your Devices" on page 3 and note which jacks you used to connect your CD player/changer. In addition, note the brand name and model number of the CD player or changer.

To Connect a Secondary CD Player:

See "Connecting Your Secondary CD Player or Tape Deck" on page 22.

Connecting Your DVD Player

Note that video device jacks are linked to specific digital jacks. For example, if you connect a DVD player with a digital optical cable, you should connect the analog cables to the VIDEO 4 video device jacks and the digital cable to the VIDEO4 digital OPTICAL jack.

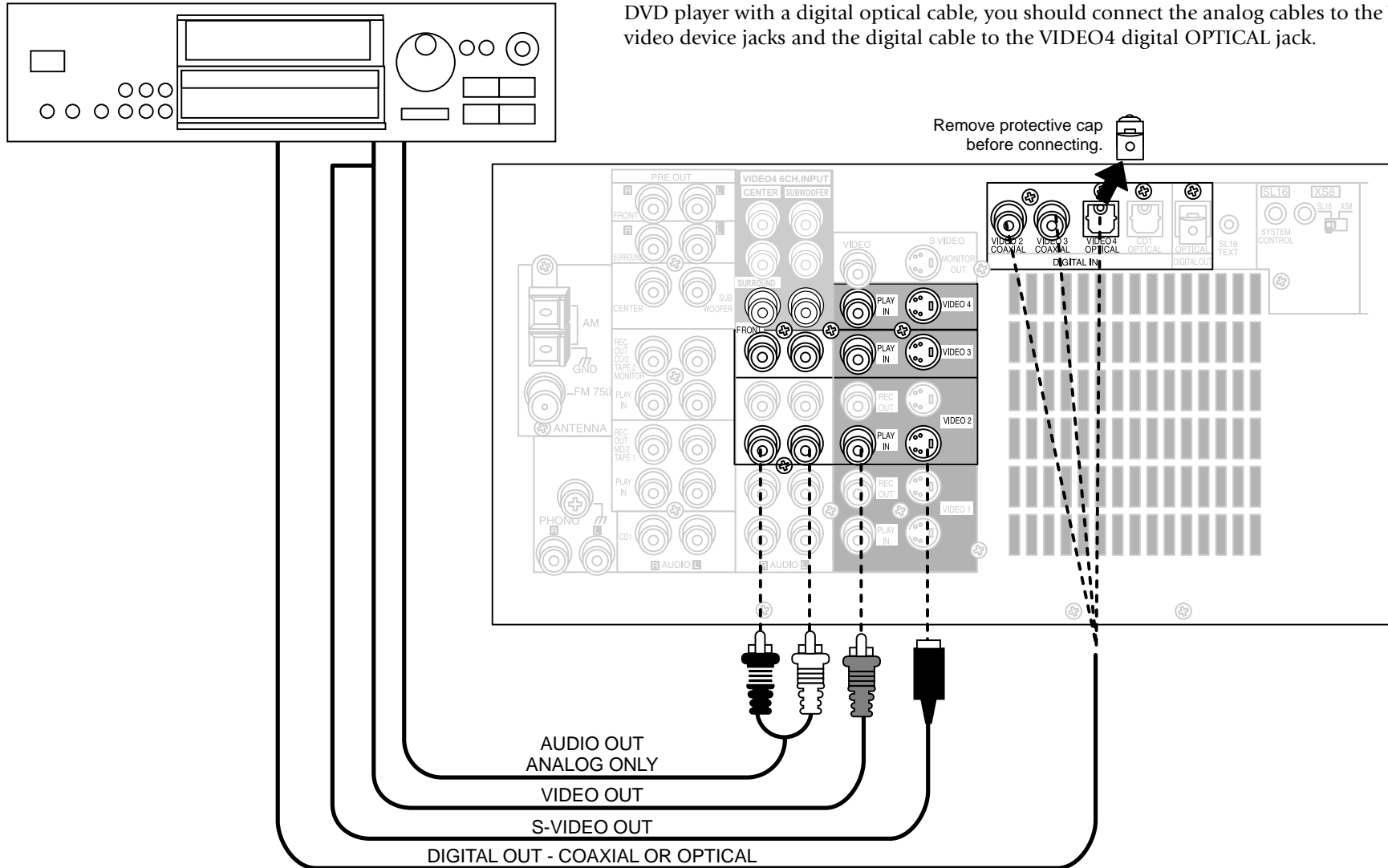

NOTES

Do not plug in the receiver to AC power until you have connected all your devices.

This section focuses on the connections from your DVD player to the KRF-X9992D. Please refer to your DVD player's instructions for more detail about its connection jacks and capabilities.

The instructions in this section show one of several possible variations on connecting your DVD player. For further assistance on optional configurations, contact the store where you purchased your receiver.

Connecting Your DVD Player, continued

To Connect a DVD Player:

1. Review the information under "Before You Begin" on page 1. It contains important notes about the types of video connections you can make.
2. Look at the digital cable that came with your DVD player. Use the table below to choose a jack set:

If your digital cable is...	Choose this jack set...
optical	VIDEO4
coaxial	VIDEO2 or 3

Note that the jack sets are linked, even though they are not adjacent. You **must** connect all of the cables from your DVD player to a linked jack set. For example, if you connect the analog cables to VIDEO2 and the digital optical cable to VIDEO4, your DVD player will not work correctly.

3. Connect the audio and video cables from the DVD's Audio and Video jacks to the receiver's PLAY IN jacks as shown to the left.
4. Connect the digital cable (either coaxial or optical) from the DVD's digital jack to the appropriate digital jack on the receiver as shown to the left.

The illustration shows two digital connections, one for coaxial connection and one for optical connection. Your DVD player supports one or the other of these connection methods—**do not** connect both.

If you use the optical digital cable, be sure to remove the protective cover from the optical jack before connecting.

5. Go to "Noting Your Devices" on page 3 and note which jacks you used to connect your DVD player. In addition, note the brand name and model number of the DVD player.

DTS disclaimer clause

DTS Digital Surround™ is a discrete 5.1 channel digital audio format available on CD, LD, and DVD software which consequently cannot be decoded and played back inside most CD, LD, or DVD players. For this reason, when DTS-encoded software is played back through the analog outputs of the CD, LD, or DVD player, excessive noise will be exhibited. To avoid possible damage to the audio system, proper precautions should be taken by the consumer if the analog outputs are connected directly to an amplification system. To enjoy DTS Digital Surround™ playback, an external 5.1 channel DTS Digital Surround™ decoder system must be connected to the digital output (S/PDIF, AES/EBU, or TosLink) of the CD, LD or DVD player.

Connecting Your DVD Player Through a Surround Processor

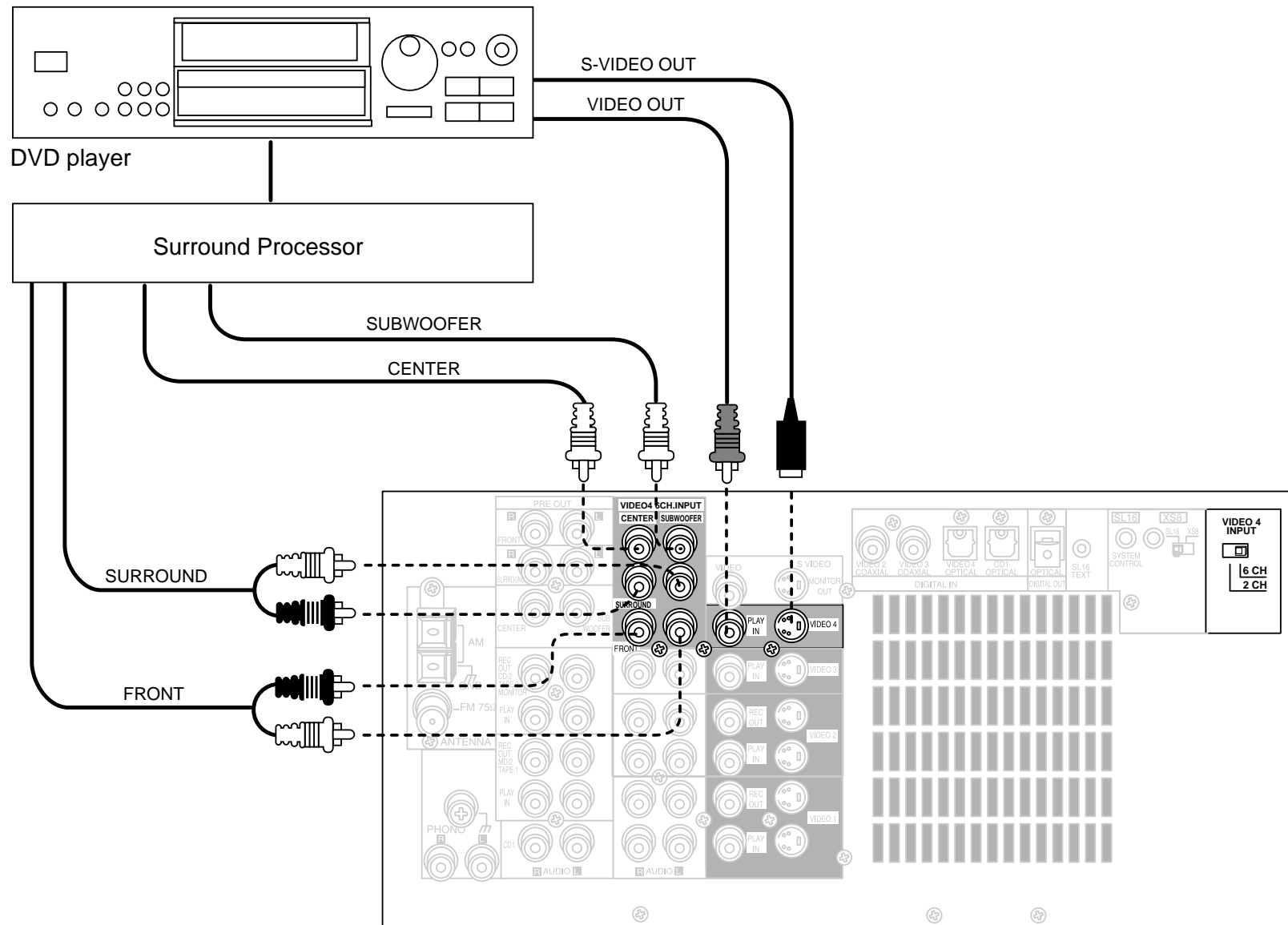

Connecting Your DVD Player Through a Surround Processor, continued



Do not plug in the receiver to AC power until you have connected all your devices.

You must purchase a multi-channel surround processor if you want to play DTS DVD discs with this receiver.

These instructions describe how to connect a DVD player through a multi-channel surround processor. If you do not plan to play any DTS DVD discs, you do not need to connect a surround processor. See "Connecting Your DVD Player" on page 17. Please refer to your DVD player's instructions for more detail about its connection jacks and capabilities.

The instructions in this section show one of several possible variations on connecting your DVD player. For further assistance on optional configurations, contact the store where you purchased your receiver.

To Connect a DVD Player through a surround processor:

1. Review the information under "Before You Begin" on page 1. It contains important notes about the types of video connections you can make.
2. Connect the digital cable from the DVD player's Digital OUT jack to the surround processor's Digital jack.
3. Connect the audio cables from the surround processor (FRONT, CENTER, SURROUND, SUBWOOFER) to the receiver's VIDEO 4 6CH. INPUT jacks as shown to the left.
4. For the video cable connection, you must use the VIDEO 4 jack set.
5. To activate the surround processor connections, you need to move VIDEO 4 INPUT switch to 6CH position before turning the system on.
6. Go to "Noting Your Devices" on page 3 and note which jacks you used to connect your DVD player. In addition, note the brand name and model number of the DVD player.

Connecting Your MD Recorder or Primary Tape Deck

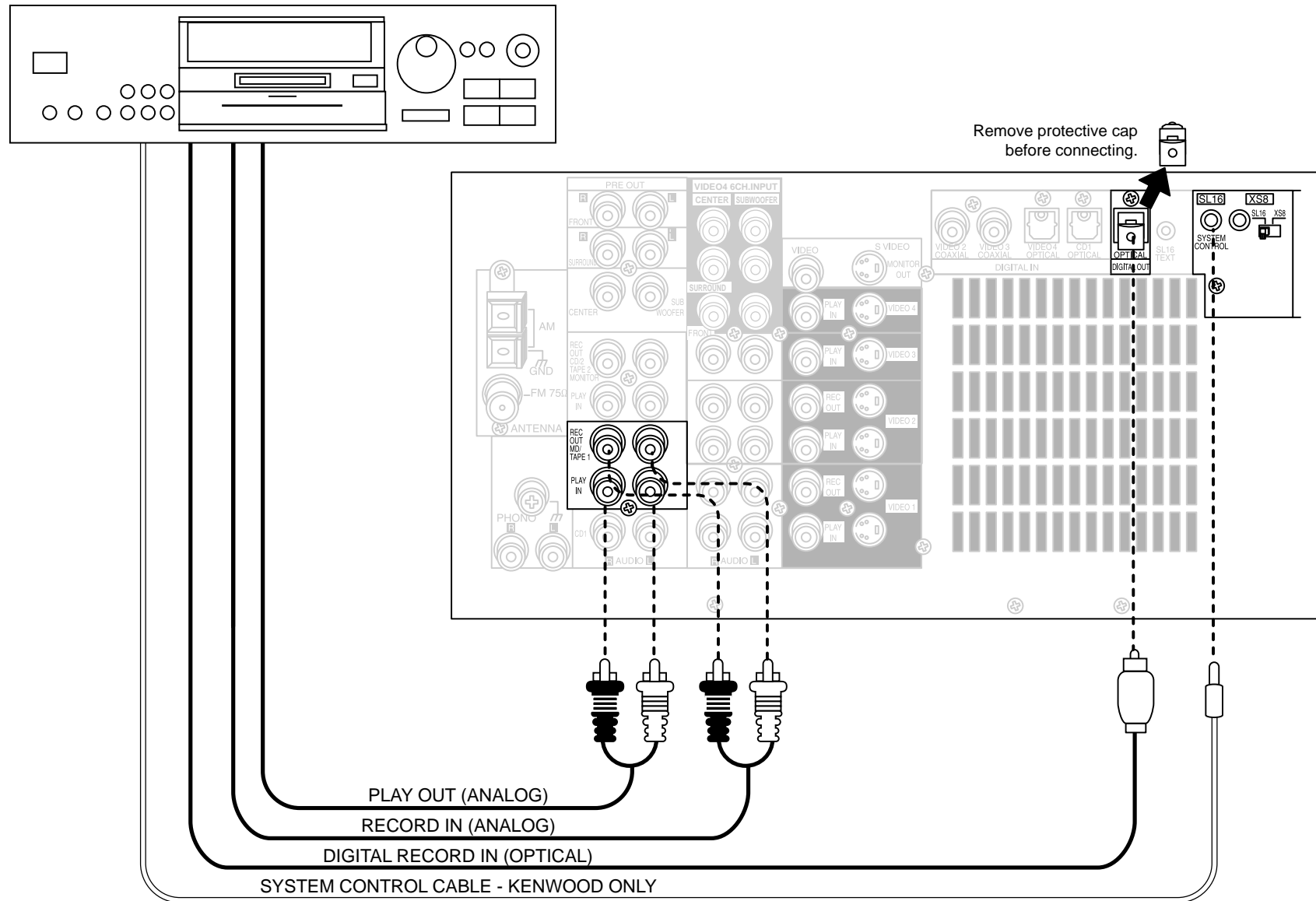

Connecting Your MD Recorder or Primary Tape Deck, continued



Do not plug in the receiver to AC power until you have connected all your devices.

This section focuses on the connections from your MD recorder or tape deck to the KRF-X9992D. Please refer to your MD recorder or tape deck's instructions for more detail about its connection jacks and capabilities.

Each set of instructions in this section shows one of several possible variations on connecting your MD recorder or tape deck. For further assistance on optional configurations, contact the store where you purchased your MD recorder or tape deck.

To Connect an MD Recorder:

1. Connect the audio cable from the MD recorder's Play OUT jacks to the receiver's MD/TAPE 1 PLAY IN jacks as shown to the left.
2. Connect the audio cable from the MD recorder's Rec IN jacks to the receiver's MD/TAPE 1 REC OUT jacks, as shown to the left.
3. Remove the cover from the receiver's OPTICAL DIGITAL OUT jack, then connect the optical digital cable from the MD recorder's REC IN jack to the receiver's OPTICAL DIGITAL OUT jack as shown to the left.

You only need to connect to the digital out jack if you will be recording from sources that are connected to a digital in jack, such as a CD or DVD player.

4. If you are connecting a Kenwood MD recorder, connect the system control cable from the MD recorder to the receiver. Be sure that the SL16/XS8 switch on the receiver is set to SL16. **(MD recorder only supports SL16 system control mode.)**

If you are connecting more than one Kenwood device with a system control cable, see "What if I Have Several Kenwood Devices (System Control Chaining)?" on page 30.

5. Go to "Noting Your Devices" on page 3 and note which jacks you used to connect your MD recorder. In addition, note the brand name and model number of the MD recorder.

To Connect a Primary Tape Deck:

1. Connect the audio cable from the tape deck's Play OUT jacks to the receiver's MD/TAPE 1 PLAY IN jacks as shown to the left.
2. Connect the audio cable from the tape deck's Rec IN jacks to the receiver's MD/TAPE 1 REC OUT jacks as shown to the left.
3. If you are connecting a Kenwood tape deck with system control, connect the system control cable from the tape deck to the receiver. Be sure that the SL16/XS8 switch on both the tape deck and the receiver is set appropriately.

If you are connecting more than one Kenwood device with a system control cable, see "What if I Have Several Kenwood Devices (System Control Chaining)?" on page 30 of the Connection and Setup Guide.

4. Go to "Noting Your Devices" on page 3 and note which jacks you used to connect your tape deck. In addition, note the brand name and model number of the tape deck.

To Connect a Secondary Tape Deck

See "Connecting Your Secondary CD Player or Tape Deck" on page 22.

Connecting Your Secondary CD Player or Tape Deck

22

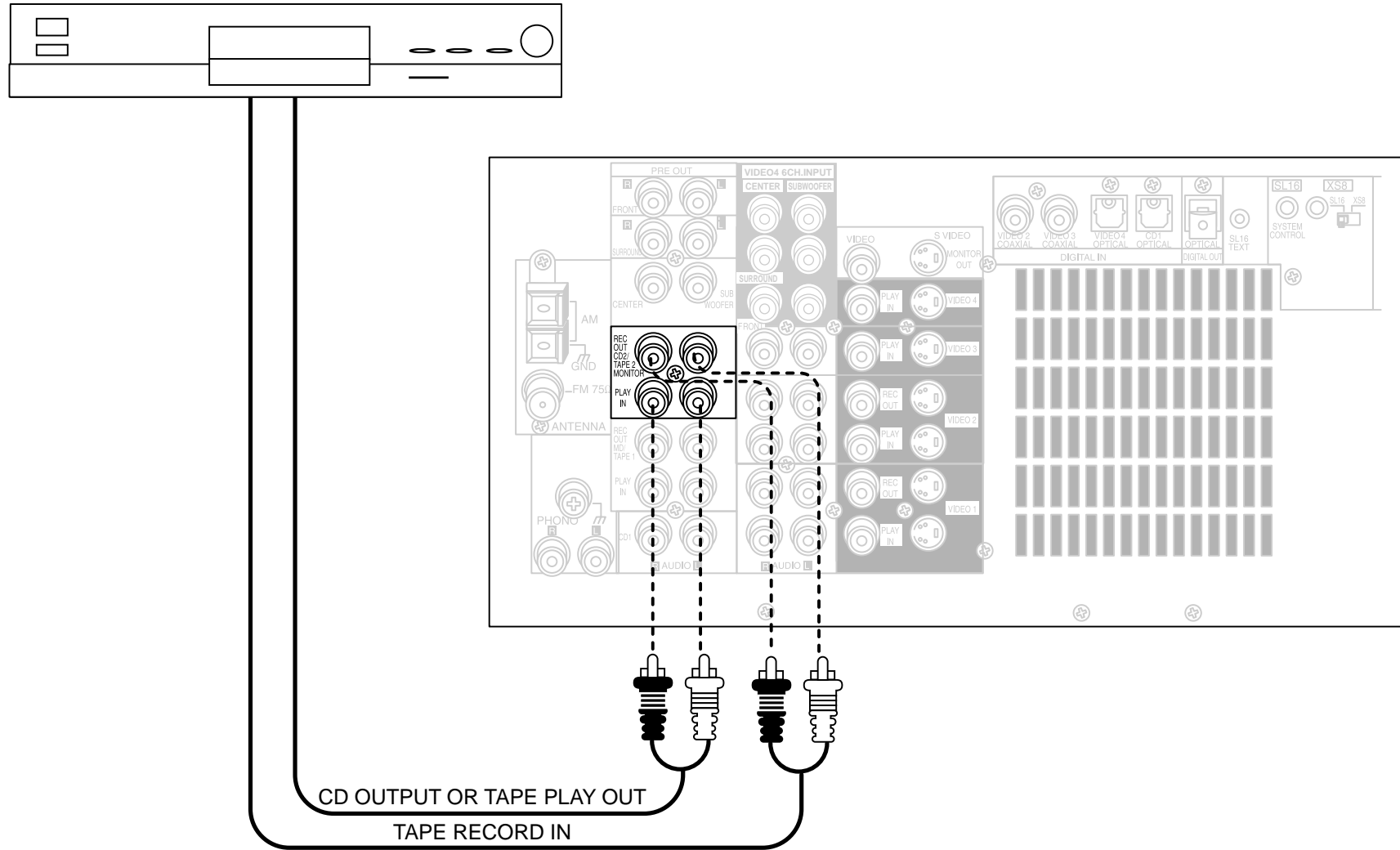

Connecting Your Secondary CD Player or Tape Deck, continued



Do not plug in the receiver to AC power until you have connected all your devices.

This section focuses on the connections from your CD player or tape deck to the KRF-X9992D. Please refer to your CD player or tape deck's instructions for more detail about its connection jacks and capabilities.

Each set of instructions in this section shows one of several possible variations on connecting your CD player or tape deck. For further assistance on optional configurations, contact the store where you purchased your CD player or tape deck.

Do not connect a system control cable from any unit connected via the CD2/TAPE2 MONITOR jacks.

To Connect a Secondary CD Player:

1. Connect the audio cables from the CD player's audio jacks to the receiver's CD2/TAPE 2 MONITOR PLAY IN jack set as shown to the left.

Do not connect the system control cable from the second CD player, even if it supports system control.

2. Go to "Noting Your Devices" on page 3 and note which jacks you used to connect your CD player. In addition, note the brand name and model number of the CD player.

If you connect a second tape deck, you cannot connect a second CD player.

To Connect a Secondary Tape Deck:

1. Connect the audio cable from the tape deck's Play OUT jacks to the receiver's CD2/TAPE 2 MONITOR PLAY IN jacks.
2. Connect the audio cable from the tape deck's Rec IN jacks to the receiver's CD2/TAPE 2 MONITOR REC OUT jacks.

Do not connect the system control cable from the second tape deck, even if it supports system control.

3. Go to "Noting Your Devices" on page 3 and note which jacks you used to connect your tape deck. In addition, note the brand name and model number of the tape deck.

If you connect a second CD player, you cannot connect a second tape deck.

Connecting Your Laser Disc Player (with AC-3 RF Output), continued



Do not plug in the receiver to AC power until you have connected all your devices.

You must purchase an RF Demodulator (DEM-9991D) if you plan to operate a player with a Dolby Digital (AC-3) RF Output with this receiver.

These instructions describe how to connect a laser disc player with an AC-3 RF Output. If your laser disc player does not have an AC-3 RF output, see "Connecting Your Laser Disc Player (without AC-3 RF Output)" on page 26. Please refer to your laser disc player's instructions for more detail about its connection jacks and capabilities.

The instructions in this section show one of several possible variations on connecting your laser disc player. For further assistance on optional configurations, contact the store where you purchased your receiver.

To Connect an AC-3 RF Output Laser Disc Player:

1. Review the information under "Before You Begin" on page 1. It contains important notes about the types of video connections you can make.
2. Connect the audio cables from the laser disc player's Audio OUT jacks to the receiver's AUDIO jacks (VIDEO2 or VIDEO3 PLAY IN) as shown to the left.
3. For the video cable connection, you *must* use the VIDEO2 or VIDEO3 jack set, as that is the set with a coaxial digital connection.
Do not connect the digital cable (coaxial or optical) yet; it must be connected via the demodulator as described in the following steps.
4. Connect the AC-3 RF coaxial cable from the laser disc player's AC-3 RF OUT jack to the demodulator's RF INPUT AC-3 RF jack as shown to the left.
5. Connect the digital cable (either coaxial or optical) from the laser disc player's digital jack to the appropriate DIGITAL INPUT jack on the demodulator as shown to the left. Set the switch on the front of the DEM-9991D to the type of connection you made.

6. Connect the coaxial digital cable from the demodulator's DIGITAL OUTPUT COAX. jack to the receiver's VIDEO2 or VIDEO3 COAXIAL jack.
7. Connect the demodulator's supplied 12V AC adapter to the DC IN jack on the demodulator. **Do not** plug the adapter into the wall until you have finished making all connections to the receiver.
8. Go to "Noting Your Devices" on page 3 and note which jacks you used to connect your laser disc player. In addition, note the brand name and model number of the laser disc player.

Connecting Your Laser Disc Player (without AC-3 RF Output)

Note that video device jacks are linked to specific digital jacks. For example, if you connect a laser disc player with a digital optical cable, you should connect the analog cables to the VIDEO 4 video device jacks and the digital cable to the VIDEO4 digital optical jack.

26

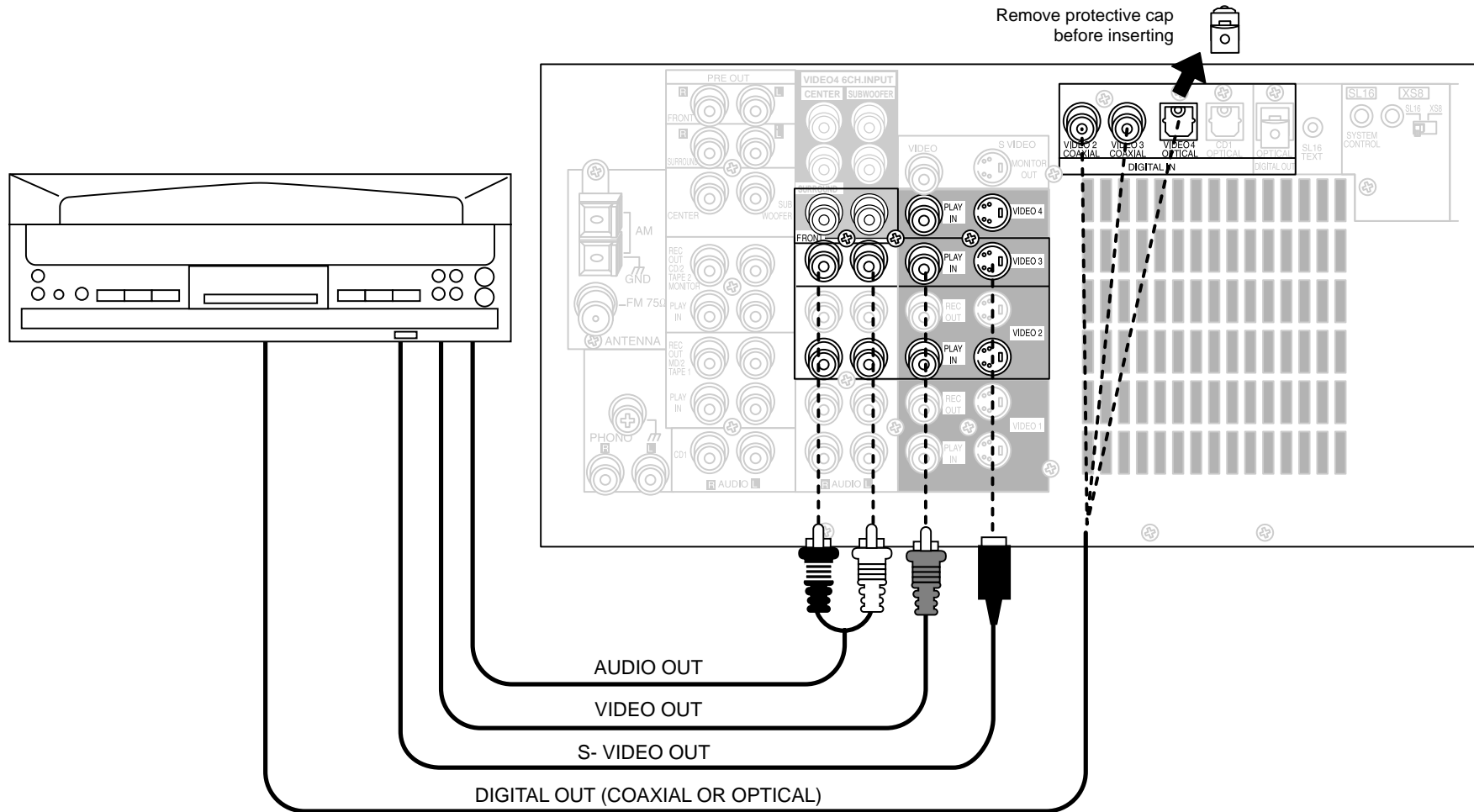

Connecting Your Laser Disc Player (without AC-3 RF Output), continued



Do not plug in the receiver to AC power until you have connected all your devices.

These instructions describe how to connect a laser disc player with a PCM Digital Output. If your player has a Dolby Digital (AC-3) RF Out, see "Connecting Your Laser Disc Player (with AC-3 RF Output)" on page 24. This configuration does not allow Dolby Digital laser discs to be played. Please refer to your laser disc player's instructions for more detail about its connection jacks and capabilities.

The instructions in this section show one of several possible variations on connecting your laser disc player. For further assistance on optional configurations, contact the store where you purchased your receiver.

To Connect a PCM Digital Output Laser Disc Player:

1. Review the information under "Before You Begin" on page 1. It contains important notes about the types of video connections you can make.
2. Look at the digital connection on your laser disc player. Use the table below to choose a jack set:

If your digital cable is...	Choose this jack set...
optical	VIDEO4
coaxial	VIDEO2 or 3

Note that the jack sets are linked, even though they are not adjacent. You **must** connect all of the cables from your laser disc player to a linked jack set. If you connect the analog cables to VIDEO2 and the digital optical cable to VIDEO4, your laser disc player will not work correctly.

3. Connect the audio cables from the laser disc player's Audio OUT jacks to the receiver's AUDIO jacks as shown to the left.

4. Connect the video cable from the laser disc player's Video OUT jack to the receiver's VIDEO PLAY IN jack as shown to the left.
5. Connect the digital cable (either coaxial or optical) from the laser disc player's digital jack to the appropriate digital jack on the receiver as shown to the left. Your laser disc player supports only one of the digital connection methods—**do not** connect both.

If you use the optical digital cable, be sure to remove the protective cover from the optical jack before connecting.

6. Go to "Noting Your Devices" on page 3 and note which jacks you used to connect your laser disc player. In addition, note the brand name and model number of the laser disc player.

Connecting Your Turntable/Record Player

28

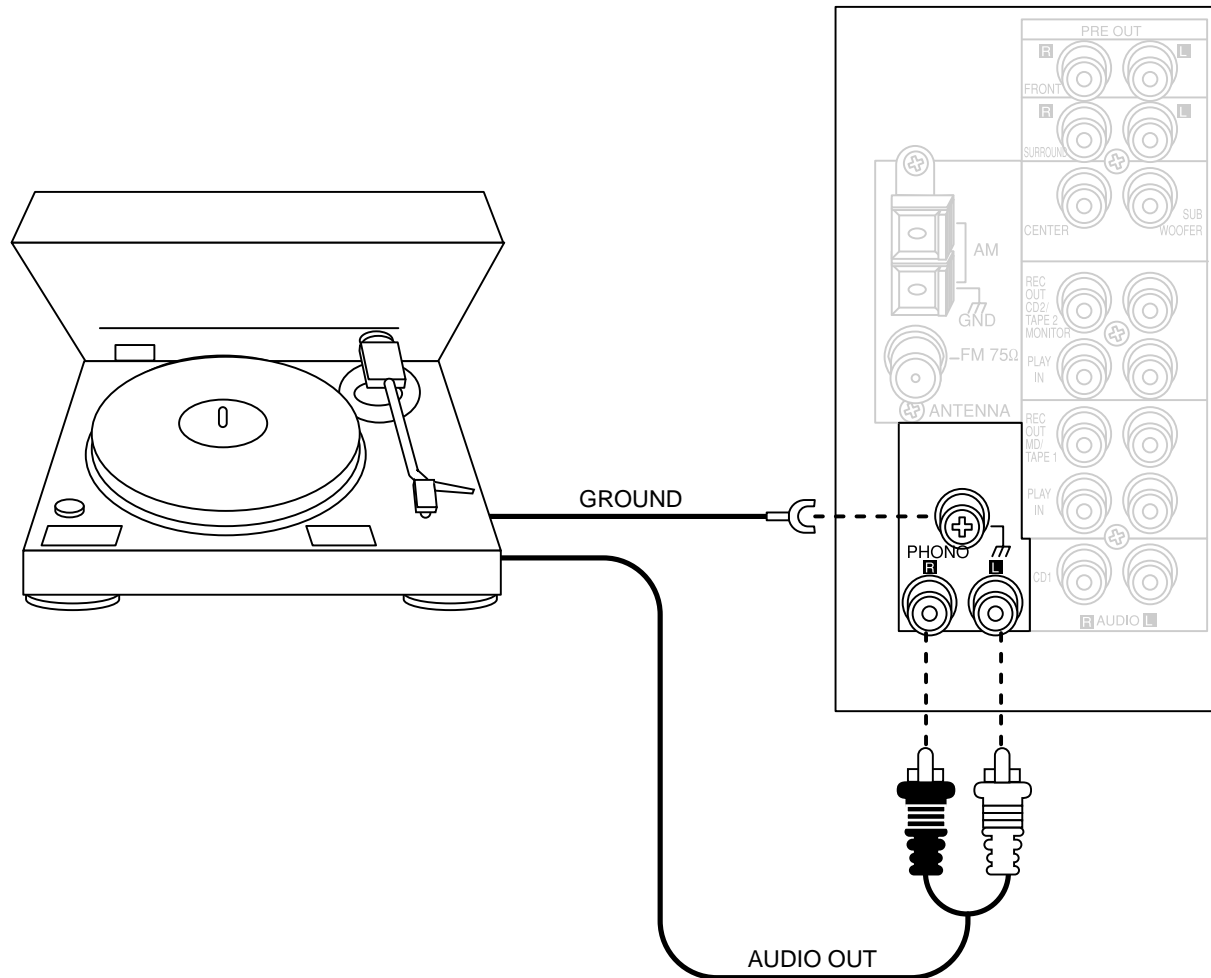

NOTES

Do not plug in the receiver to AC power until you have connected all your devices.

This section focuses on the connections from your turntable/record player to the KRF-X9992D. Please refer to your turntable/record player's instructions for more detail about its connection jacks and capabilities.

To Connect a Turntable/Record Player:

1. Connect the audio cables from the turntable audio output jacks to the receiver's PHONO R and L jacks.
2. If your turntable includes a ground cable, connect the ground cable to the receiver's PHONO ground jack.
3. Go to "Noting Your Devices" on page 3 and note which jacks you used to connect your turntable. In addition, note the brand name and model number of the turntable.

Connecting a Camcorder or Additional VCR

This section focuses on the connections from your camcorder or VCR to the front of the KRF-X9992D. Please refer to your camcorder or VCR's instructions for more detail about its connection jacks and capabilities.

These instructions describe how to connect a camcorder or VCR quickly and probably temporarily to the front of the receiver. If you want a less cluttered and more permanent connection, see "Can I Connect an Additional VCR Permanently?", below.

To Connect a Camcorder or Additional VCR:

Connect the audio and video cables from the camcorder or VCR's Audio and Video jacks to the receiver's front panel jacks as shown to the left.

29

Can I Connect an Additional VCR Permanently?

Yes. To do so, follow the instructions under "To Connect a Secondary VCR:" on page 13.

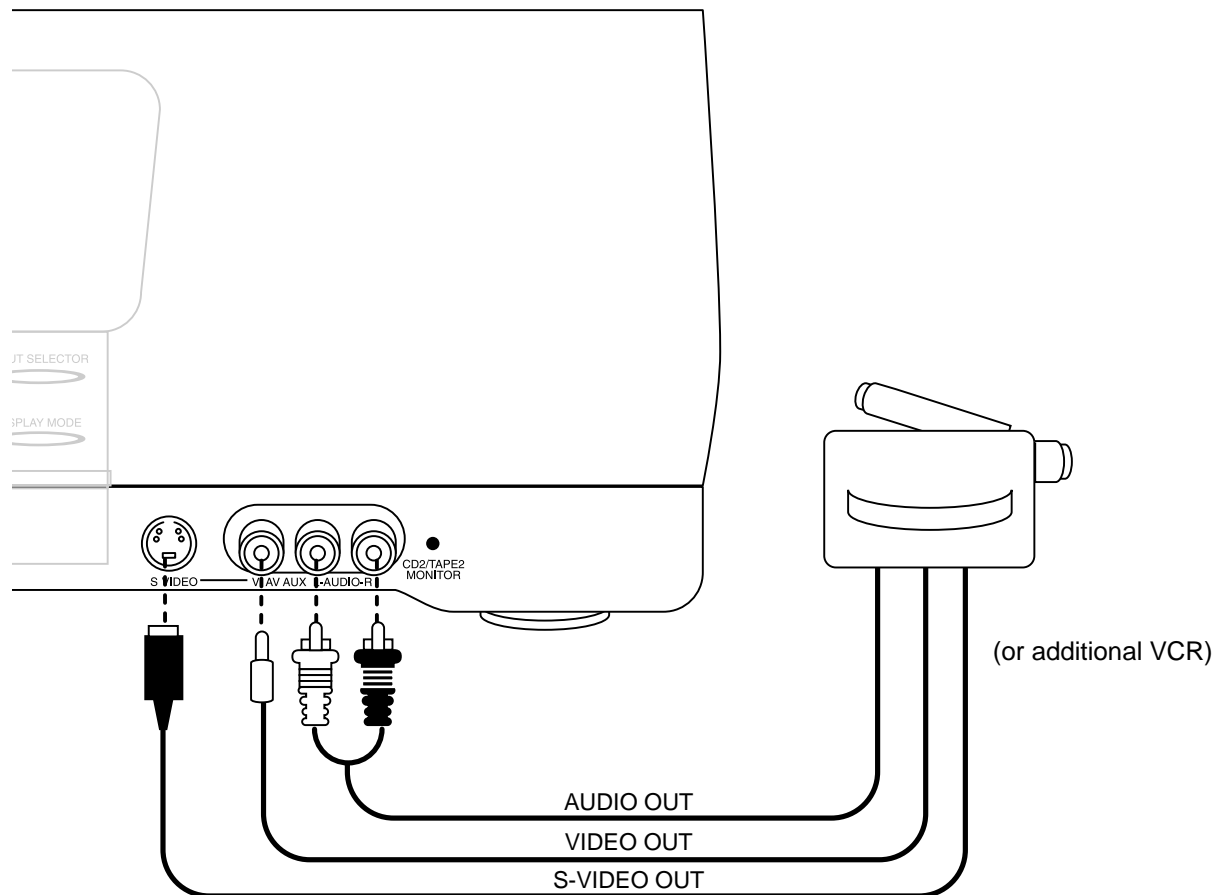

What if I Have Several Kenwood Devices (System Control Chaining)?

Kenwood provides convenient control of the entire system via two control modes:

- SL16, which allows you to connect SL16 devices only
- XS8, which allows you to connect XS, XS8, and XR devices

You cannot mix SL16 and XS8 settings. All devices connected via system control cables must use the same setting.

An Example of SL16 Chained Connections:

30

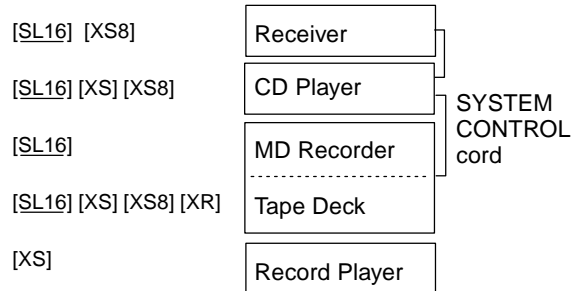

An Example of XS8 Chained Connections:

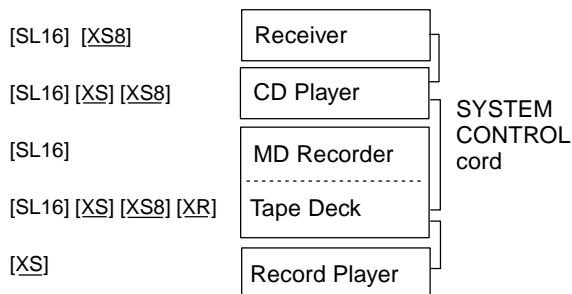

To switch between the two modes :

1. Slide the selector switch (shown below) from SL16 (the factory-set default) to XS8.
2. Turn the receiver's power switch off, and on again.

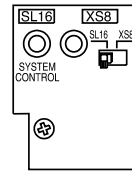

System Control connection allows you to:

- See the current status of the selected source device, such as *Play* or *Stop* (SL16 devices only).
- control connected devices via the remote
- switch the receiver's input automatically to a connected device when you start playback from that device
- synchronize recording a CD automatically when you start playback from the connected CD player



Make sure the units are connected to the correct jacks on the receiver—for example, no device connected to the CD2/TAPE 2 MONITOR jacks can use a system control cable.

Some CD players and cassette decks do not support the SL16 system control mode. Do not include these devices in a set of SL16 chained connections; where appropriate, use the XS8 mode instead.

Do not mix connections of the two modes: if a device does not support the mode you are using for chaining, do not connect that device.

Do not connect system control cables to any device not specified by Kenwood. Using system control functions with a device that does not support them can damage the device.

Make sure system control plugs are firmly seated in the appropriate jacks.

Connecting the Antennas

AM Loop Antenna

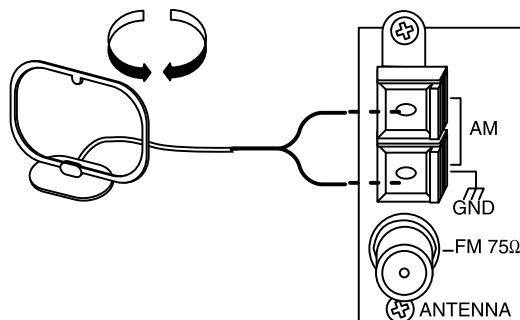

Your new receiver comes with an AM loop antenna for AM radio reception. To connect the AM antenna:

1. Insert the antenna loop into the base and position the loop.
2. Open the receiver's antenna terminal levers.
3. Insert the antenna's wires into the terminal as shown above.
4. Close the antenna terminal levers to lock the wires in place.
5. Adjust the antenna loop as necessary to improve reception.

NOTES

To prevent hum interference, keep the AM antenna wires away from speaker wires, AC power cords, the TV chassis, and the receiver.

FM Indoor Antenna

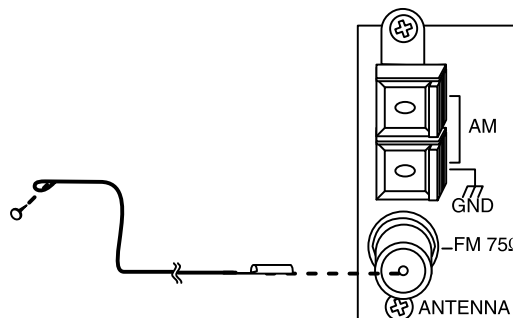

Your new receiver also comes with an FM indoor antenna for FM radio reception. To connect the FM antenna:

1. Attach the antenna sheath to the pole in the center of the receiver's FM antenna jack, as shown above. When you attach the sheath for the first time, you may need to exert quite a bit of pressure.
2. Adjust the antenna as necessary to improve reception.
3. Tack the looped end of the antenna in the location that provides the best reception.

FM Outdoor Antenna

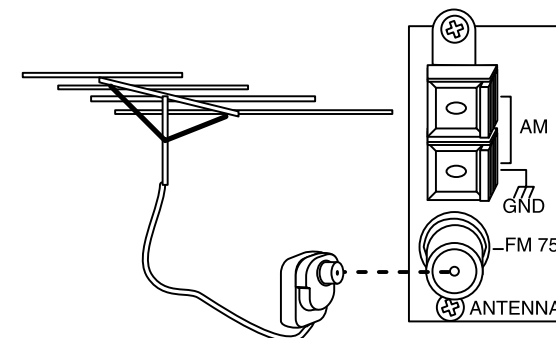

Kenwood recommends a permanently installed outdoor FM antenna for best FM reception. To connect an outdoor FM antenna:

1. Connect the antenna wire to a standard, commercially available antenna adapter as shown above.
2. Connect the adapter to the receiver's FM antenna jack.

What if I Have Cable Radio?

If you have cable radio, contact your cable provider for assistance with connecting to the KRF-X9992D.

Chapter Two: Setting Up PowerTouch

Your new PowerTouch controls your new receiver and can be set up to control most components attached to it. PowerTouch appears and functions a little differently from traditional remotes. It incorporates sophisticated engineering and design to allow you to simply touch the screen to press buttons and operate controls. You can touch the screen with your finger or with the stylus stored at the top of the PowerTouch.

Because it can control so many different devices, it presents a separate set of controls for each device on an LCD screen. Touch an icon on the screen to access further menus or controls for devices.

Only devices previously identified and connected to the receiver will appear as icons on the display screen. If you are "missing" an icon on your display screen, make sure you have identified the device to PowerTouch. This chapter describes identifying devices to PowerTouch.

This chapter contains the following sections:

Installing the Batteries	page 32
Calibrating the Touch Screen	page 33
Navigating PowerTouch Interface	page 34
Setting Up Speakers	page 34
Identifying Devices For PowerTouch Control	page 37
Storing Radio Stations in Memory	page 40

Installing the Batteries

32 Before you can set up any PowerTouch item, you need to install batteries.

- The batteries that came with your new PowerTouch are intended for you to use for an operation check—they may not last as long as ordinary batteries. We recommend replacing them with alkaline batteries for normal use.

To install the batteries:

1. Press down and back on the battery cover to remove it.

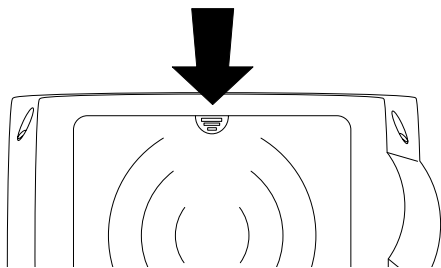

2. Insert six AA batteries as shown below:

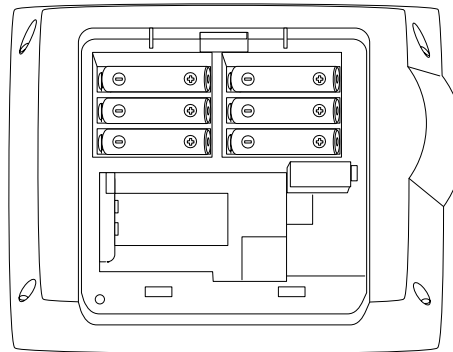

3. Close the cover.

If you use PowerTouch outside of its range (see "How is PowerTouch Powered?" on page 5 of the *Users' Guide*) PowerTouch's display may show incorrect information.

When your batteries begin to run low, PowerTouch displays a Low Battery message. Clear the message by touching check mark icon (☑) and replace all 6 batteries as described here.

Maximize the life of your batteries by turning the Backlight off if you are not trying to use PowerTouch in the dark. For more information on the Backlight, see the *Users' Guide*.

If you cannot see anything on the screen after replacing batteries, try to adjust the screen contrast. See 61 page of the *Users' Guide*.

NOTES

Under some circumstances (for example, if you plan to use multiple remotes), you can set PowerTouch up to communicate via a hardwired cable and be powered by a AC adapter/wall cube. If you choose this setup option, you should contact the store where you purchased your receiver.

After you install the batteries or reset PowerTouch, you need to calibrate the touch screen. The touch screen responds to pressure from the included stylus or your finger:

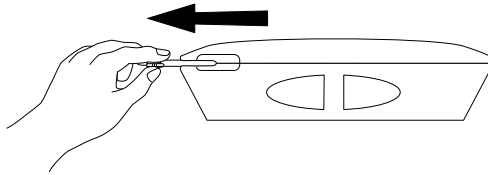

If you are replacing batteries and complete the battery replacement within 3 minutes, you do not need to calibrate the screen; calibration is stored in memory.

If the screen's performance begins to change, you can recalibrate it without resetting PowerTouch by pressing **Calib.** on the Setup Preference menu. For more information about accessing this menu, see "Identifying Devices For PowerTouch Control" on page 37.

Calibrating the Touch Screen

To calibrate the touch screen, use the stylus to touch the center of each of the calibration points displayed

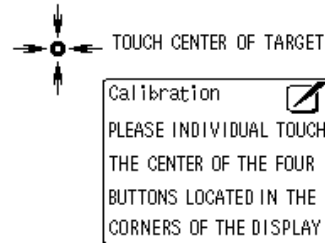

When you touch each calibration point, you should hear a beep and see the next point, indicating that area of the screen is now calibrated. If you do not hear a beep, touch the calibration point until you do.

The touch screen is sensitive to pressure, not to movement. Press firmly but gently on any touch screen element. The screen will not respond if you simply brush the stylus or your finger along the surface.

Resetting PowerTouch

If you want to reconfigure PowerTouch, you can reset it. You do not need to do this unless you experience a problem.

1. Open the cover.
2. Use the stylus to press the blue button at the bottom of the battery case:

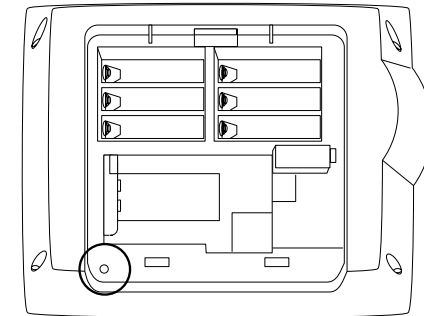

The items you set up in this chapter will remain in PowerTouch. If you want to make it to the factory-set default condition, please follow the instructions on page 78 of the *Users' Guide*.

PowerTouch presents a “map” of the menus you have available:

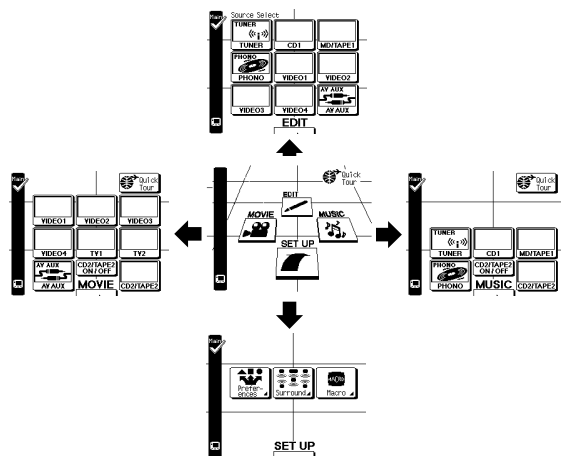

34

For convenience, PowerTouch zooms in on and displays only a portion of this map at a time. The boxes on the illustration above surround what you will see on the screen for each area of the map.

There are three ways to navigate this map:

- Use the stylus or your finger to touch a button on the Main menu. The touch screen will “fly” you over the map to that menu. Touch  to return to the Main menu.

Navigating PowerTouch Interface

- Push the joystick in the direction you want to go. The touch screen will “fly” you over the map to the menu. You can only use the joystick this way when you are at the Main menu. To return to the Main menu, always push the joystick “down” (toward the volume button).
- Use the stylus or your finger to touch a Quick Access button (the blue buttons on the left side of the screen). The touch screen will jump immediately to that menu. Touch  to return to the Main menu.

Quick Tour PowerTouch includes a Quick Tour to familiarize you with the options available and how to access them. You may want to run the Quick Tour before you begin setting up devices. To start the Quick Tour, use the stylus or your finger to touch .

For the rest of this chapter, you will be using the various settings on the Setup menu. The Setup menu includes the following settings and their subsettings:

- Preference, which contains the following:
 - IR (“Identifying Devices For PowerTouch Control” on page 37)
 This menu setting allows you to identify your connected devices to PowerTouch.

- Input (*KRF-X9992D Users’ Guide*)
- Surround (“Setting Up Speakers” on this page) These menu settings allow you to set up speakers and subwoofer, set the distance from your speakers to the listening area, determine speaker levels, and set the surround speaker type. The Next button on each screen takes you to the next group of settings (i.e., pressing Next at SP Selection takes you to SP Distance without having to go back to the menu).
- Macro (*KRF-X9992D Users’ Guide*) This menu setting allows you to create custom macros that perform several operations (such as turning a device on, changing the receiver’s input, and changing a TV station) with a single touch.

Setting Up Speakers

Before you can begin using the receiver to control your home entertainment system, you must set up PowerTouch to operate your speakers effectively. There are four areas of speaker setup:

- SP Selection
- SP Distance
- SP Level
- Bass Peak Level

You can set up your speakers in the order presented here (via the Next button) or individually, selecting each option from the Surround menu.

The receiver must be on, speakers must be connected, and Speaker A on the front panel must be turned on before you can set up speakers.

To begin setting up speakers:

1. Touch  on the Main menu to access the Setup menu.

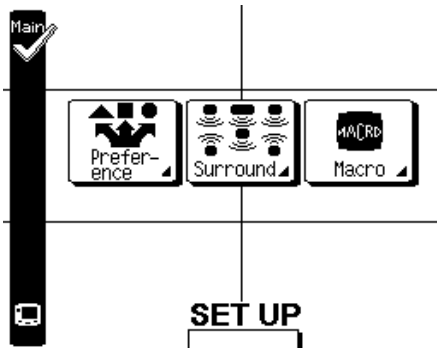

2. Touch  on the Setup settings.

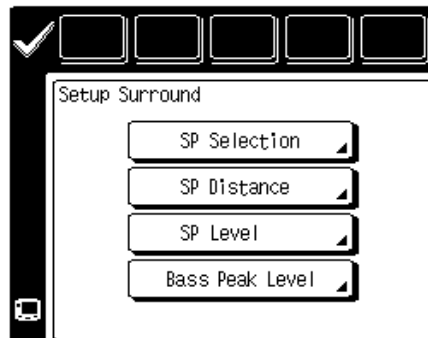

SP Selection

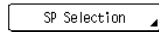

1. Touch  on the Setup Surround menu to open the Speaker Selection menu:
2. Kenwood provides two ways to set up your speakers:

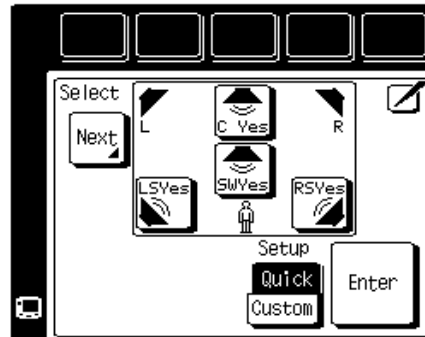
Quick Setup: Use this method for a simplified setup where you identify whether a speaker is present and let the receiver automatically determine the appropriate speaker settings.



- a. Aim PowerTouch at the receiver. If the speaker is present, touch the speaker button until "Yes" appears in the button. (SW=subwoofer, C=center, LS=left surround and RS=right surround):

If you selected Yes for the subwoofer, all of the bass below 80Hz is removed from other speakers in your system and is sent to the subwoofer in all listening modes. This improves your speakers' power handling and reduces overall distortion.

- b. Touch  to save your settings.
- c. Touch  to move to the next speaker setting or touch  to return to the Surround menu.

Custom setup: Use this method for a more customized setup where you determine more of the speaker settings, such as the bandwidth of the sound sent to each speaker. Custom setup configures the following: SW=subwoofer, L=left front, R=right front, C=Center, LS=left surround and RS=right surround.

- a. Touch  on the Speaker Selection menu:

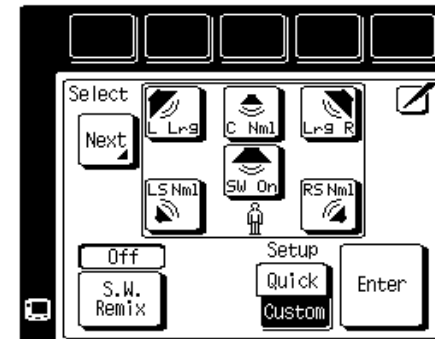

- b. Aim PowerTouch at the receiver and touch the speaker button until the correct setting appears (see below).

The left and right front buttons and the left and right surround buttons are linked; if you touch one, you change the settings for both.



- **Off** means you are not using the speaker. (Not available for front speakers). If no subwoofer is connected, all bass below 80Hz is sent to left and right front speakers.
- **On** means that you are using the speaker. (Only available for subwoofer).
- Select **Nml** (= Normal) if the speaker is not capable of producing clean, deep bass energy at output levels that match those produced by a typical powered subwoofer. All bass below 80Hz in that channel is removed from that speaker and is sent to the subwoofer in all listening modes. Most speakers should be considered **Nml**.
- Select **Lrg** (= Large) if the speaker is capable of producing clean, deep bass energy at output levels that match those produced by a typical powered subwoofer. All bass below

80Hz in that channel is left in that speaker in all listening modes. Full-range speakers capable of this level of bass performance are very uncommon, and are almost always too large to be used as center or surround speakers.

If you set your left and right front speakers to Lrg and have a subwoofer in the system, the subwoofer will only receive bass in Stereo mode and during Dolby Digital and MPEG programs. In Dolby Pro Logic, Dolby 3 Stereo, and DSP modes, the subwoofer will not receive any signal at all.

- c. If you set your left and right front speakers to Lrg and want to send bass to the subwoofer in all Listen modes, touch  until "On" appears above the button. In Dolby Pro Logic, Dolby 3 Stereo, and DSP modes SW Re-Mix mixes some of the bass from your left and right front speakers back into your subwoofer.

If you set your left and right front speakers to Nml, SW Re-Mix does not function.

- d. Touch  to save your settings.
- e. Touch  to move to the next speaker setting or touch  to return to the Surround menu.

36

NOTES

If your front speakers are set to **Nml**, you can only set your center and surround speakers to **Nml** (or **OFF**).

If you turn off the subwoofer, your front speakers are automatically set to Lrg. You may not set them to Nml.





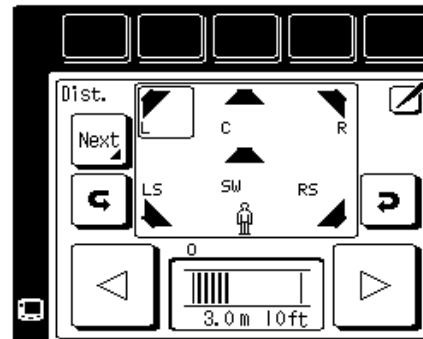

SP Distance

1. Measure the distance from each speaker to the seat you most often use and note it below:

Speaker	Distance (ft or m)
left front	
center	
right front	
left surround	
right surround	
subwoofer	

2. If you are not already there, touch  on the Setup Surround menu to open the Speaker Distance menu:





3. Touch  or  to set the distance for the left front speaker.
4. Touch  or  to select the next speaker.
5. Repeat steps 3 and 4 for each speaker.
6. Touch  to move to the next speaker setting or touch  to return to the Surround menu.





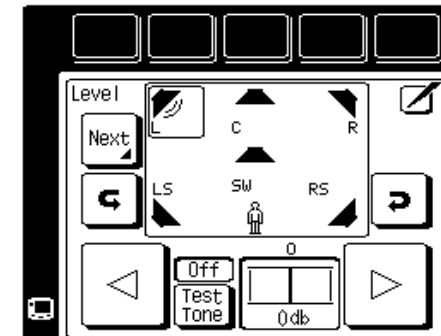

SP Level

In this step you will use your ears to balance the volume level of all the system's speakers *except the subwoofer* for your room and listening position. (To set the subwoofer level, see "Setting the Subwoofer Level" on page 37.) When all the speakers are set at the same volume level, your system will create a more realistic, spacious surround sound environment.

1. Eliminate as many external noise sources as possible.
2. Sit in the place where you and your guests are most likely to sit while watching movies or listening to music.
3. If you are not already there, touch  on the Setup Surround menu to open the Speaker Level menu:





4. Touch  until the Test Tone display reads "Manu".
5. The receiver's master volume will become 0 dB, and test noise will play from the left front speaker. Please note that the test tone is quite loud.

6. Touch  or  to select the next speaker.
7. Carefully listen to the volume level of the test noise. If the noise is a different volume than the noise from the left front speaker, use  or  to adjust the volume so that the volume matches the volume from the left front speaker. (Do not be concerned with the volume number readout on the Level display—this is for reference purposes only. Use your ears to determine if the two speakers are playing at the same volume).
8. Repeat steps 6 and 7 until all the system's speakers (except the subwoofer) play at the same volume.
9. To confirm the volume levels, touch  until the Test Tone display reads "Auto." The test noise will automatically cycle between all of the speakers. Fine-tune the channel levels as necessary.
10. When all the channels sound like they're the same volume, you've balanced your system.
11. To turn off the test noise, touch  until the Test Tone display reads "Off."

Setting the Subwoofer Level: Because of the way humans hear, the test noise the Speaker Level menu sends through the subwoofer will not sound as loud as it really is. (The Speaker Level menu subwoofer test noise is designed to

be used with a sound pressure level meter for balancing.) Because of this, you cannot use that test noise to properly calibrate the level of your subwoofer by ear. To set the subwoofer level, listen to familiar music or films that have strong bass content and adjust the subwoofer level until it sounds balanced with the rest of the speakers.

12. Touch  to move to the next speaker setting or touch  to return to the Surround menu.





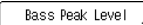

Bass Peak Level

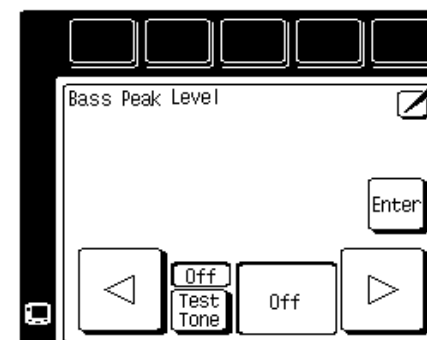
Because of the way humans hear, the test noise the Speaker Level menu sends through the subwoofer will not sound as loud as it really is. (This Speaker Level menu subwoofer test noise is designed to be used with a sound pressure level meter for balancing.) Because of this, you cannot use that test noise to properly calibrate the level of your subwoofer by ear. The PowerTouch contains a separate setup menu for the subwoofer.

To set the subwoofer level:

1. If you are not already there, touch  on the Setup Surround menu to open the Bass Peak Level menu.



2. Touch  until the Test Tone display reads "On".
3. Test noise will play from the subwoofer. Carefully listen to the volume level of the noise.
4. Use the left () or right () Level arrows to raise the volume until the sound will be almost distorted.
5. Touch  to save your settings.
6. Touch  to return to the Surround menu.
7. Touch  to return to the Setup menu. Touch it again to return to the Main menu. You are now finished setting up the speakers.

37

Identifying Devices For PowerTouch Control

Once your speakers are set up and configured, you must identify your component devices to PowerTouch. PowerTouch can be set up to control any device: if the device code is not already part of PowerTouch's extensive library, you can use the Learn feature to teach the device's commands to

PowerTouch. You can also use this Learn function to expand the control capabilities of existing codes. For more information, see "What if my device does not work with any of the codes on the list? What if I Want PowerTouch to Control Additional Functions?" on page 39.

How Do I Identify Devices?

1. Make sure you have installed batteries.
2. Touch  on the Main menu to access the Setup menu.

3. Touch  on the Setup menu to access the Preference menu.

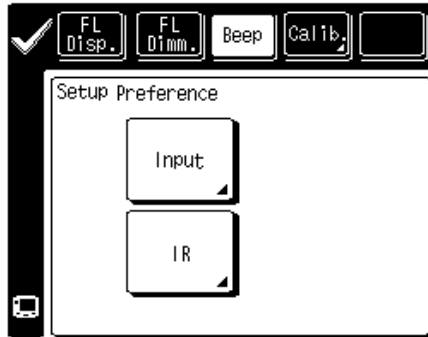

- 38 4. Touch  on the Preference menu to access the IR Setup menu.

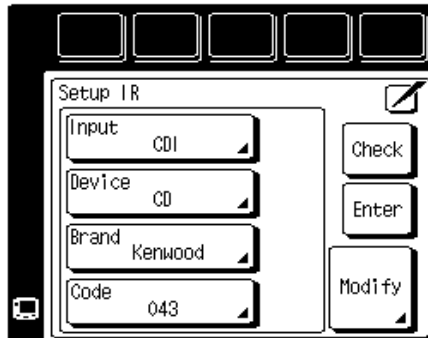

5. Refer to "Noting Your Devices" on page 3 where you noted which device was connected to which jack set.

6. Touch  to open the list of available jack sets:

- TV1 and TV2 (these allow PowerTouch to control your TV or cable tuner, even if isn't connected to one of the receiver's input jack sets).
- VIDEO1 through VIDEO4
- CD1
- MD/TAPE1
- CD2/TAPE2

Note that Phono and AV AUX (the additional camcorder/VCR jack set on the front of the receiver) do not need to be configured here.

Touch the jack name on the list.

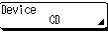
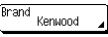
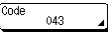
7. Touch  to select the type of device you have connected to the jack set.
8. Touch  to select the device's brand.
9. Touch . You can now choose from a list of all the codes available for the device. Touch the first code on the list.

- If the devices are connected with a system control cable, be sure to select the code preceded by "Sys-" or "System". This instructs PowerTouch to send all commands for the device to the receiver, which will control the device via the system control cable.
- If you have a Kenwood Dual-Play 200-Disc CD Changer, you will need to set both CD1 and CD2/ TAPE2 to the correct code for this device ("Sys- Mega").

10. Touch . This instructs PowerTouch to send a "power" test signal to the receiver. If your device turns on, the code you entered was correct. If it does not turn on, try the next code in the list. Continue until one of the codes works. If none of the codes work, see "What if my device does not work with any of the codes on the list?" on page 39.

If you enter the code preceded by "Sys-" or "System" on step 9, skip this step.

11. When you have a code that works, touch . Check off that device on your list.

Repeat steps 5 through 11 until you are finished identifying devices to PowerTouch. When you are done, turn to "How Do I Operate Devices?" on page 26 in the *Users' Guide* and note which icon corresponds to which connected device.

How Do I Replace a Setup Code with a New One?

If you purchase a new device to replace an existing device, you will need to identify the new device to PowerTouch. To do so:

1. Connect the device as described in the appropriate section of Chapter One in this guide.
2. Follow the steps under "How Do I Identify Devices?" on page 37. When you touch it will replace the other code.

How Do I Delete Setup Codes?

If you disconnect a device and do not plan to replace it, you may want to delete the setup code from PowerTouch. To do so:

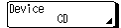
1. Follow the steps under "How Do I Identify Devices?" on page 37 to select a jack set.
2. Touch . Scroll to the device "Nothing" then touch it. That device is no longer controlled by PowerTouch.

What if my device does not work with any of the codes on the list?

What if I Want PowerTouch to Control Additional Functions?

PowerTouch contains sophisticated features that allow it to "learn" new commands from other IR remotes. If none of the codes for the device and brand you select work, use this feature to instruct PowerTouch how to operate the device.

You can also use this feature to modify commands for codes that do work or even to add extra functionality to those codes.

For example, let's say the basic control codes for your VCR are Power, Play, Rewind, Fast Forward,

Pause, Channel and Record. Let's also say that your VCR has an OSD (On Screen Display) menu that is not part of the default code set you chose. You can use your VCR's remote to teach PowerTouch to access that menu.

To teach PowerTouch new commands:

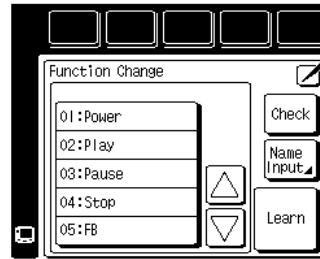

1. Follow the steps under "How Do I Identify Devices?" on page 37. Pick any code for the device brand; PowerTouch must have a code to learn device commands.

2. Touch  to open the Function Change menu:



3. Touch an empty button (1 to 8).

You will be able to access these new commands by touching **More** or the button you assign on any device control screen. (*Users' Guide*)

4. Touch  and use the "keyboard" and the stylus to enter a command name (e.g., CD: On). Touch  on the keyboard to save the name and touch .

5. Aim the device's remote at PowerTouch and press and hold the button *on the device's remote* that corresponds to the command you want PowerTouch to learn:



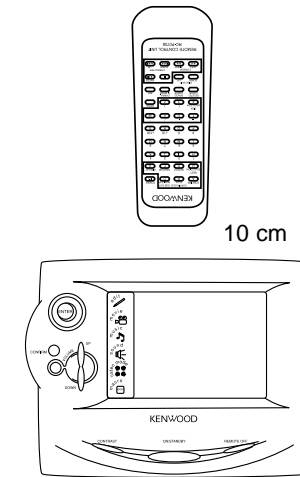

Audio-Video Receiver KRF-X9992D



This may take a few seconds; do not move PowerTouch or the device's remote until PowerTouch displays the Function Change menu again.

After a learning process is completed, always touch  to test the command or function that PowerTouch has learned. If the command or function does not work, perform the learning process again.

Be sure to use the device's original remote. PowerTouch will not learn commands from other universal remotes.

6. Repeat steps 3 through 5 until you have taught PowerTouch all the commands you want it to know. If you need more function lines, touch  or  to access more lines.
7. Touch  to return to the IR Setup menu.
8. Touch  to return to the Preference menu. Touch  to return to the Setup Menu, and again to return to the Main menu.

Storing Radio Stations in Memory (optional)

Your new PowerTouch provides two ways to store radio stations:

- RDS Automatic Memory, which searches for stations broadcasting an RDS signal and automatically stores them in the first available storage button.
- Manual Memory, which allows you to enter and store specific stations.

NOTES

There are 40 preset storage buttons available.

40

Search for and store RDS stations first, then set stations manually. The search function automatically assigns RDS stations to the first storage button, overwriting any stations already stored there.

You can overwrite RDS stations with manually stored stations.

Storing RDS Stations Automatically

1. Touch  on the Main menu to access the Music menu.

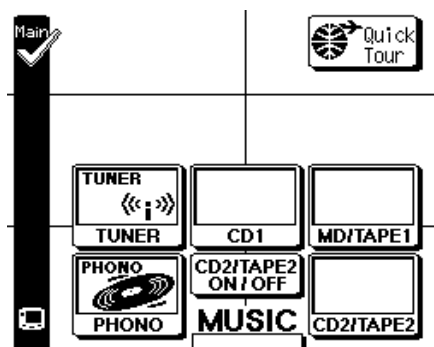

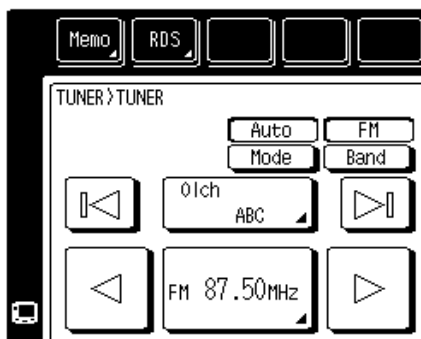

2. Touch  on the Music menu to access the Tuner controls.

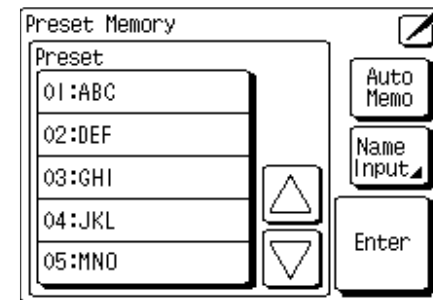

3. Touch  to choose FM.

4. Touch  at the top of the screen:



5. Touch . The receiver locates and stores any FM stations broadcasting an RDS signal. This process can take a few minutes to complete; please be patient. While the receiver is searching, the tuner indicator on the receiver's front panel blinks.

NOTES

RDS stations are stored in the order they are found, up to 40 stations. If the search finds fewer than 40 stations, the receiver may automatically store other FM stations in the open storage buttons.

If you are repeating the RDS search, any existing preset stations (whether automatically or manually stored) will be replaced by the results of the new search.

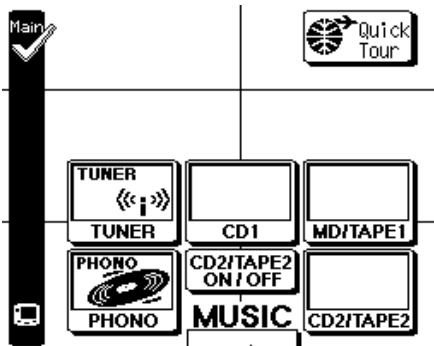

Storing Stations Manually

1. Touch  on the Main menu to access the Music menu.



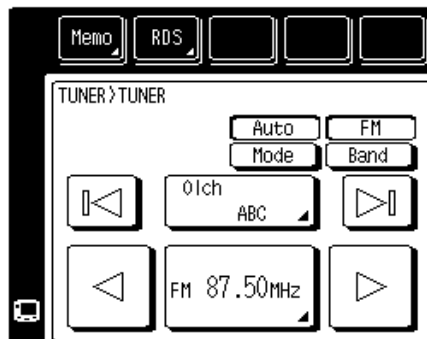



2. Touch  on the Music menu to access the Tuner controls.



3. Touch  to choose the receiving band.
4. Touch  to switch between Auto tuning and Manual tuning. Select Manual if you experience interference due to weak radio signals.

5. Choose the station you want to store using one of the following methods:

- Touch  or  until the station's broadcast frequency appears.
- Touch  and enter the broadcast frequency using the 10key pad. (e.g.; To select FM 108.0 MHz, enter 1, 0, 8, 0, 0, and )

6. Touch  at the top of the screen:

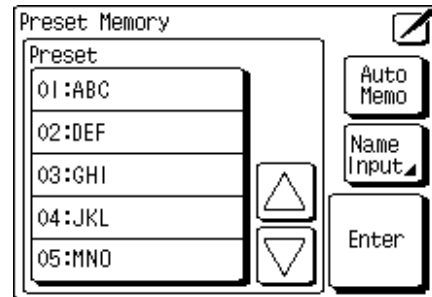





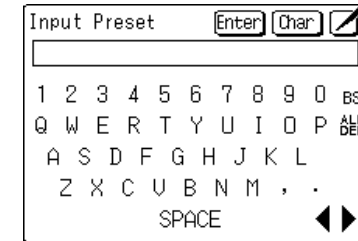

7. Touch a storage button. Use  or  to access more storage buttons.

If you choose a storage button that already has a station assigned, the new station will replace the previously-stored station.

8. (Optional) Touch  to enter a name for the station in the Preset Memory menu:



- Use the stylus to select characters from the keyboard.
 - Touch  to access to lowercase characters. Touch it again to access special characters (such as @, !, &, etc.). Touch it a third time to return to uppercase characters.
 - Touch  or  to move back and forth between the characters.
 - Touch  (backspace) to clear the last character you entered. Touch  to delete all the characters in the line.
 - Touch  to save your title.
9. Touch  to tune to the newly saved station and return to the Tuner controls.
 10. Repeat steps 3 through 9 for each station you want to store.

Chapter Three: Specifications

Read this page carefully to ensure safe operation.

KRF-X9992D Specifications

Audio Section

Rated Output Power during stereo operation
 63 Hz ~ 12.5 kHz, 0.7 % T.H.D. , 6 Ω (DIN/IEC)
 130W + 130 W

Effective Output Power during surround operation
Front
 1 kHz, 0.06 % T.H.D. at 6 Ω, one channel driven
 130 W + 130 W
Center
 1 kHz, 0.06 % T.H.D. at 6 Ω, one channel driven 130 W
Surround
 1 kHz, 0.06 % T.H.D. at 6 Ω, one channel driven
 130 W + 130 W

Total Harmonic Distortion 0.004 % (1 kHz, 65 W, 6 Ω)

Frequency Response (IHF'66)
 CD1 5 Hz ~ 80 kHz, +0.5 dB, -3 dB

Signal to Noise Ratio (IHF '66)
 Phono (MM) 76 dB
 CD1 96 dB

Input Sensitivity / Impedance
 Phono (MM) 2.5 mV / 47 kΩ
 CD1 200 mV / 47 kΩ
 6ch input 200 mV / 47 kΩ

Output Level / Impedance
 Tape Rec 200 mV / 220 Ω
 Pre Out (Front, Center, Surround, Subwoofer) 1 V / 500 Ω

Tone Control
 Bass ± 7 dB (at 100 Hz)
 Treble ± 7 dB (at 10 kHz)

Loudness Control
 Volume at -40 dB level +7 dB (100 Hz), +4 dB (10 kHz)

Digital Audio Section

Sampling Frequency 32 kHz, 44.1 kHz, 48 kHz
Input Level / Impedance / Wavelength
 Optical -15 dBm ~ -21 dBm, 660 nm ±30 nm
 Coaxial 0.5 Vp-p / 75 Ω

Output Level / Impedance / Wavelength
 Optical -15 dBm ~ -21 dBm, 660 nm ±30 nm

Video Section

Video Inputs / Outputs

Video (composite) 1 Vp-p / 75 Ω
 S Video (luminance signal) 1 Vp-p / 75 Ω
 (chrominance signal) 0.286 Vp-p / 75 Ω

FM Tuner Section

Tuning Frequency Range 87.5 MHz ~ 108 MHz

Usable Sensitivity (DIN)

Mono 1.2 μV (75 Ω) / 13.2 dBf (40 kHz dev., S/N 26 dB)
 Stereo 45 μV (75 Ω) / 44.2 dBf (46 kHz dev., S/N 46 dB)

Total Harmonic Distortion (DIN at 1 kHz)

Mono 0.2 % (65.2 dBf input)
 Stereo 0.8 % (65.2 dBf input)

Signal to Noise Ratio (DIN weighted, 1kHz)

Mono 65 dB (40 kHz dev., 65.2 dBf input)
 Stereo 60 dB (40 kHz dev., 65.2 dBf input)

Stereo Separation (DIN at 1 kHz) 36 dB

Selectivity (DIN, ±300 kHz) 64 dB

Frequency Response 30 Hz ~ 15 kHz, +0.5 dB, -3.0 dB

MW (AM) Tuner Section

Tuning Frequency Range 531 kHz ~ 1,602 kHz

Usable Sensitivity (30 % mod., S/N 20 dB)

..... 16 μV / (600 μV/m)

Signal to Noise Ratio (30 % mod. 1 mV input) 50 dB

General

Power consumption 600 W

AC outlet

Switched 2 (total 100 W max.)

Dimensions W: 440 mm (17-5/16")
 H : 162 mm (6-3/8")
 D : 391 mm (15-3/8")

Weight (Net) 15.2 kg (33.5 lb)

NOTE: Do not use contact cleaning agents because they could cause a malfunction. Be especially careful not to use contact cleaning agents containing oil, since they may deform the plastic components.



Kenwood follows a policy of continuous advancements in development. For this reason, specifications may be changed without notice.

Full performance may not be exhibited in extremely cold locations (below 0 deg. C).

Numerics

200-Disc CD Changer
 connecting 15
 connecting SL16 text cable 15
 identifying to PowerTouch 37
 SL16/XS8 switch 15

A

AM antenna
 connecting 31
 preventing hum interference 31
 amplifier
 connecting 6
 analog cables
 DVD player 17
 laser disc player 25, 27
 antennas, connecting 31
 audio cables
 200-Disc CD Changer 15
 cable TV 11
 camcorder 29
 DVD player 17
 laser disc player (AC-3 Output) 25
 laser disc player (no AC-3 Output) 27
 MD recorder 21
 primary tape deck 21
 satellite tuner 11
 second tape deck 23
 surround processor 19
 VCR 13, 29

B

batteries, installing in PowerTouch 32

C

cable radio, connecting (call provider) 31
 cable TV
 connecting 10, 11
 identifying to PowerTouch 37
 with RCA video output 11
 without RCA video output 11
 cables 1, 11
 camcorder, connecting 29
 CD player, connecting 14, 15
 center speaker, connecting 5
 clearing PowerTouch stored settings 33

coaxial cable
 DVD player 17
 laser disc player 25, 27
 communication cable, connecting 14
 connecting
 200-Disc CD Changer 15
 AM antenna 31
 amplifier 6
 antennas 31
 audio cable to MD recorder 21
 audio cables to VCR 13
 cable radio (call provider) 31
 camcorder 29
 CD player 14, 15
 DVD player 16, 17, 18, 19
 FM antenna 31
 laser disc player with AC-3 Output ... 24, 25
 MD recorder 20, 21
 other primary CD player 15
 primary tape deck 21
 second VCR 13, 29
 speakers 4
 surround processor 19
 system control cable to primary
 tape deck 21
 tape deck 20, 21
 turntable/record player 28
 turntable's ground cable to receiver 28
 TV 8
 VCR 12, 13, 29
 video cables to VCR 13
 video-CD compatible CD player 15
 connection warning
 analog cables, laser disc player 25
 DVD player 17
 laser disc player 25, 27
 second CD player 23
 second tape deck 23
 control modes
 mixing connections 30
 mixing settings 30
 switching between 30

D

deleting, PowerTouch setup codes 39
 devices
 identifying to PowerTouch 37
 digital cable
 CD player 15
 DVD player 17
 laser disc player (AC-3 Output) 25
 laser disc player (no AC-3 Output) 27
 digital connection warning 25
 Dolby Digital (AC-3) RF Out 25
 DVD player
 connecting 16, 17, 18, 19
 identifying to PowerTouch 37

F

FM antenna, connecting 31
 front speakers, connecting 5

G

ground cable, connecting turntable 28

H

hum interference 31

L

laser disc player
 identifying to PowerTouch 37
 RF Demodulator 25
 with AC-3 Output, connecting 25
 with PCM Digital Output, connecting 27
 without AC-3 Output, connecting 27
 without Dolby Digital Output,
 connecting 27
 left speakers
 front, connecting 5
 surround, connecting 5

M

MD recorder, connecting 20, 21

N

navigating PowerTouch interface 34

O

optical cable
 200-Disc CD Changer 15
 DVD player 17
 MD recorder 21

P

PCM Digital Output laser disc player,
 connecting 27
 powered subwoofer, connecting 4, 6
 PowerTouch
 bass peak level 37
 clearing stored settings and
 reconfiguring 33
 deleting setup code 39
 identifying devices 37
 installing batteries 32
 introductory information 32
 navigating the display screen 34
 replacing old setup code with new 39
 selecting main menu 34
 selecting speakers 35
 setup menu 34
 speaker distance, setting 36
 speaker level, setting 36
 storing radio stations 40

R

radio stations, storing in memory 40
 RDS stations, storing in PowerTouch 40
 record player/turntable, connecting 28
 right speakers
 front, connecting 5
 surround, connecting 5

S

S video cable
 cable TV 10
 DVD player 16, 18
 laser disc player 24, 26
 satellite tuner 10
 VCR 12
 satellite tuner
 connecting 10, 11
 identifying to PowerTouch 37

second tape deck
 connecting 23
 connecting audio cable 23
 connection warning 23
 identifying to PowerTouch 37

second VCR
 connecting 13, 29
 identifying to PowerTouch 37

setup codes
 deleting 39

setup menu, on PowerTouch 34

SL16
 200-Disc CD Changer 15
 chained connections 30
 system control mode 30
 XS8 switch, 200-Disc CD Changer 15

speakers
 connecting 4
 setting with PowerTouch 34

specifications 42

storing radio stations in memory 40

subwoofer
 connecting 4, 6

44 supplemental power amplifiers, connecting 7

surround sound
 connecting speakers 5

system control cables
 200-Disc CD Changer 15
 CD player 15
 connection warning 30
 MD recorder 21
 tape deck 21

system control chaining 30

T

tape deck
 connecting 20, 21
 identifying to PowerTouch 37

turntable/record player, connecting 28

TV
 connecting 9
 identifying to PowerTouch 37
 watching without using receiver 9

V

VCR
 connecting 12, 13
 identifying to PowerTouch 37

video cables
 another VCR 29
 cable TV 11
 camcorder 29
 DVD player 17, 19
 laser disc player (AC-3 Output) 25
 laser disc player (no AC-3 Output) 27
 satellite tuner 11
 TV 9
 VCR 13

video CD-compatible CD player, connecting . 15

X

XS8 chained connections, example of
 chained components 30

NOTES

KENWOOD

For your records

Record the serial number, found on the back of the unit, in the spaces designated on the warranty card, and the space provided below. Refer to the model and serial numbers whenever you call upon your dealer for information or service on this product.

Model _____ Serial Number _____

how to



operate and enjoy your

KRF-X9992D



**Digital Audio/Video
Receiver**

KENWOOD
Users' Guide

88D-4327-00 0-1  (T)  98 12

Using Your New Kenwood Audio-Video Receiver

Welcome to the Users' Guide for your new Kenwood Audio-Video Receiver.

The **KRF-X9992D** connects all your current audio and video components. It allows you to control them all with Kenwood's remarkable PowerTouch touch screen remote—a graphical user interface without having to use your TV!

NetFront™
Easy Communication Everywhere

NetFront® by Access Co., Ltd. is adopted for this product.
Copyright© 1996, 1997 Access Co., Ltd.
NetFront® is registered trademark of Access Co.,Ltd. in Japan.

Table of Contents

Chapter One: Moving Around	1
What's on the Front Panel of Your Kenwood Audio - Video Receiver?	2
What's on PowerTouch?	3
What's on PowerTouch's Screen?	4
How is PowerTouch Powered?	5
How Do I Use PowerTouch?	6
How Do I Move Around?	7
How Do I Enter Text?	7
Chapter Two: Using PowerTouch	9
How Do I Adjust the Sound?	10
Turning the Speakers On	10
Adjusting the Volume	10
Adjusting the Loudness (Stereo Mode Only)	11
Adjusting the Tone (Stereo Mode Only)	11
Adjusting Speaker Levels	13
Muting Sound	15
Midnight Theatre Function	15
What are Listen Modes?	16
Switching to Analog Input	21
Applying Digital Signal Processor (DSP) Effects	22
Applying THX technologies	24

What if I Want to Use Headphones?	25
How Do I Operate Devices?	26
Movie Devices	27
TV	28
VCR	31
DVD Player	33
Laser Disc Player	34
Camcorder or Additional VCR	35
Music Devices	36
Kenwood 200-Disc CD Changer	36
Displaying Disc and Track Titles	38
Single or Rotary CD Player	43
MD Recorder or Tape Deck	46
Turntable	49
Second CD Player or Tape Deck	49
Tuner	50
How Do I Record (Edit Mode)?	56
How Do I Adjust PowerTouch's Display?	60
How Do I See PowerTouch in the Dark?	60
How Do I See PowerTouch's Screen More Clearly?	61
How Do I Turn the Beeping On or Off?	61
Using PowerTouch to Dim or Brighten the Receiver's Front Panel	62
Changing the Front Panel Display Mode	62

How Do I Perform Several Actions at Once?	63
Creating Macros	64
Using Macros	68
Chapter Three: Troubleshooting	70
Sound	72
I don't hear any sound at all	72
I can't hear sound from one or more of the speakers, or the sound is abnormally low	72
I can't hear sound from my surround or center speakers ...	73
I can hear sound only from the center speaker when Dolby Pro Logic or Dolby 3 Stereo is selected	73
Sound from one (or more) of my devices is abnormally loud or soft	73
There wasn't any sound recorded on tapes made on my VCR or tape deck	75
The initial sound is intermittent or non-existent when I start to play from a Dolby Digital or DVD source	75
With a Dolby Digital program, the loud sounds aren't very loud and the quiet sounds aren't very quiet	75
I hear a hum when I select the PHONO input	76
Video	76
I can't see the program I'm playing on the TV There wasn't any video output to my VCR when I recorded	76
PowerTouch	76
I don't see icons for all my devices	76

When I select a device icon, I don't see any commands	76
My PowerTouch is slow to respond—sometimes I have to press buttons or select commands several times	77
My PowerTouch is not responding	77
My PowerTouch is beeping. What does that mean?	78
PowerTouch does not "learn" new commands or functions	78
I want to clear all the items in PowerTouch and make it to the factory-set default condition	78
Receiver/Tuner	79
My receiver won't turn on and the STANDBY indicator is flashing	79
The sound is distorted, and the CLIP indicator on the receiver's front panel flashes red continually, or stays red for more than 1 second at a time	80
I can't access any RDS (Radio Data System) functions	82
I can't receive a radio station	82
I'm getting a lot of static/interference	82
When I press a key to tune to a preset station, the receiver does not respond	83
Macro is not running as I programmed	83
When the listen mode is in "6ch Input", there are commands which the receiver does not accept.....	83

Chapter One: Moving Around

Welcome to the Kenwood KRF-X9992D *Users' Guide*. This chapter explains the buttons and functions you can find on the front of the receiver and on the PowerTouch. The chapter also includes an explanation of how to navigate the convenient graphical display on your new PowerTouch.

It includes the following sections:

What's on the Front Panel of Your Kenwood Audio - Video Receiver?	page 2
What's on PowerTouch?	page 3
How is PowerTouch Powered?	page 5
How Do I Use PowerTouch?	page 6

What's on the Front Panel of Your Kenwood Audio-Video

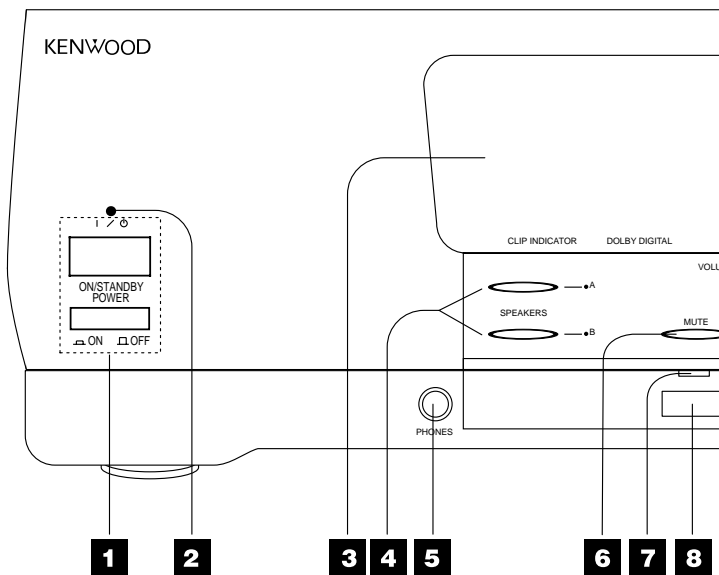

1. Power On/Standby button
2. Standby indicator light
3. Display panel
4. Speaker selector buttons (see page 10)
5. Headphone jack
6. Mute button (see page 15)
7. IR indicator
8. IR transmitters
9. Volume control knob
10. Display Mode button (see page 62)

Receiver?

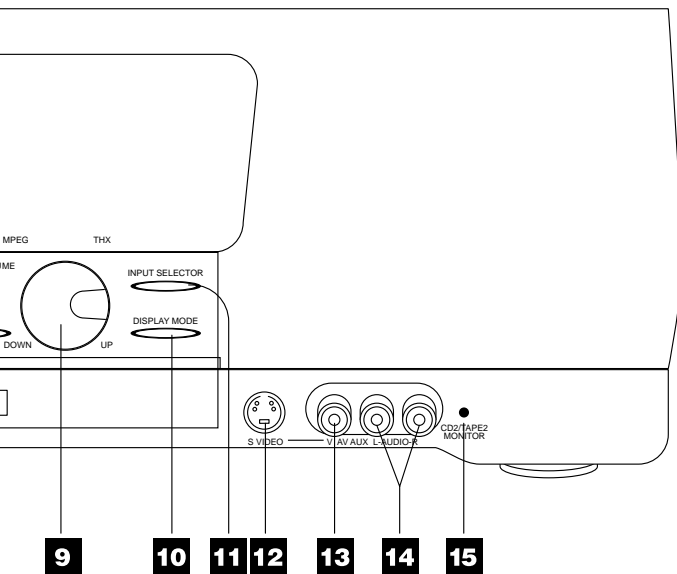

11. Input selector button
12. AV AUX S VIDEO jack
13. AV AUX composite video jack
14. AV AUX audio jacks
15. CD2/Tape 2 Monitor indicator light

Standby mode

While the standby indicator of the unit is lit, a small amount of current is flowing into the unit's internal circuitry to back up the memory. This condition is referred to as the standby mode of the unit. While the unit is in the standby mode, it can be turned ON from the remote control unit.

What's on PowerTouch?

What's on PowerTouch?

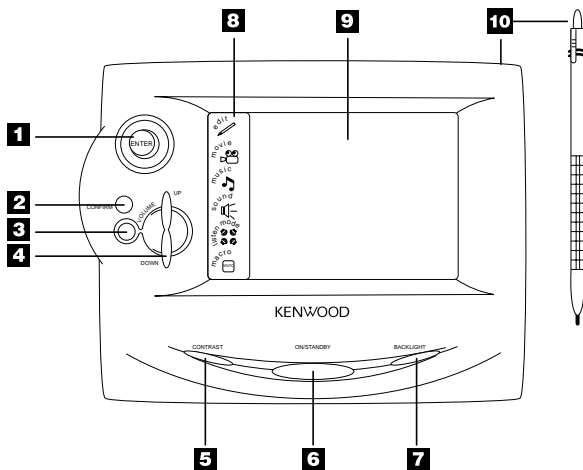

1. Joystick (see page 7)
2. Confirm button
3. Mute button (see page 15)
4. Volume up/down button (see page 10)
5. Contrast button
6. On/Standby button
7. Backlight button (see page 60)
8. Quick Access menu
9. Touch screen display
10. Stylus (stored on top edge)

What's on PowerTouch?

What's on PowerTouch's Screen?

PowerTouch's LCD display screen is divided into two sections: the Quick Access Menu and the Device Control/Menu Section. Use your finger or the stylus to touch the buttons in each area.

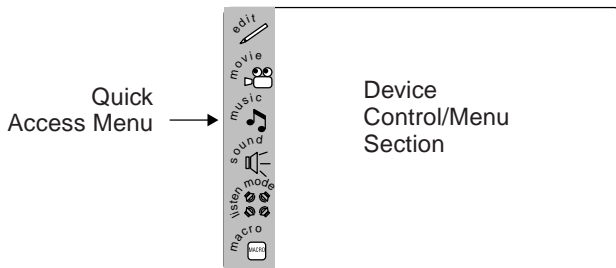

PowerTouch also includes a QuickTour, which you can use to familiarize yourself with operating devices using the touch screen.

Touch  to familiarize yourself with operating devices using the touch screen. QuickTour provides a short narration for each major area that will automatically clear and move to the next topic. When it is finished it returns you to the main menu.

The Quick Access Menu: The buttons in the Quick Access Menu are always available, regardless of what else is displayed on the touch screen. Touch these buttons for instant access to:

- editing features
- Movie device controls such as DVD players or VCRs
- Music device controls such as CD players or the radio tuner
- Sound controls, such as loudness or "Midnight" mode
- Listen modes such as stereo, Dolby Digital or MPEG
- user-defined Macro functions that let you perform a series of tasks with a single button touch. These macros are also available on each device's More screen.

How is PowerTouch Powered?

The Device Control/Menu Section: The device control section provides the same kinds of access as the Quick Access menu, but with more structure. Use the Main menu to navigate through the feature menus to exactly the feature or device you want to use.

Using these features, your Kenwood PowerTouch can store and display a large number of tasks, making it easier for you to access features. You get all the advantage of on-screen graphical display, without having to use a TV screen!

For more information on using these icons, see "How Do I Use PowerTouch?" on page 6.

How is PowerTouch Powered?

Your new PowerTouch uses 6 AA alkaline batteries and operates in the following range:

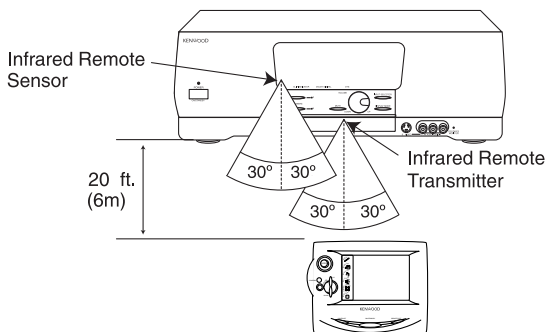

If you use PowerTouch outside of this range, PowerTouch's display may show incorrect information, or may not operate.

As you use PowerTouch, be aware of the following:

- When PowerTouch's operating range gets shorter or PowerTouch displays a low battery alarm, replace all 6 batteries:

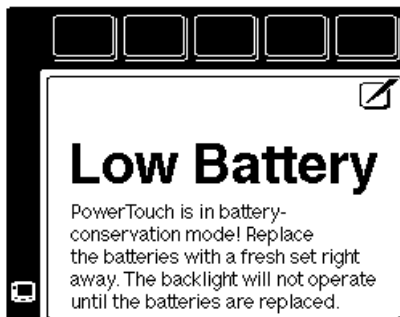

- Do not install the receiver where direct sunlight or high-frequency fluorescent lighting can shine directly into the infrared remote sensor. This can limit PowerTouch's operating range.

How Do I Use PowerTouch?

Use your new PowerTouch to control your new receiver and most devices attached to it. PowerTouch appears and functions a little differently from traditional remotes. Because it can control so many different devices, it displays a separate set of controls for each device on an LCD screen.

Only devices you have identified and connected to the receiver appear as buttons on the touch screen. If you are "missing" a device's icon on the movies or music screen, make sure you have identified the device to the PowerTouch. For more information on identifying devices to the PowerTouch, see "Chapter Two: Setting Up PowerTouch" in the *Connections and Setup Guide*.

How Do I Use PowerTouch?



Do not block the IR transmitter on the front panel of the receiver or on PowerTouch. Even a brief blockage while it is transmitting (such as someone walking by) can cause the communication and feedback to become erratic temporarily. If this happens, press CONFIRM  and PowerTouch will resume normal operation (you might need to reenter the interrupted command).

How Do I Move Around?

1. Press any button or touch the screen to active PowerTouch's display.
2. Use the stylus or your finger to touch the menu or control button you want to use.



If you are looking at the Main menu, you can use the joystick to move to a different menu. Push the joystick

- to the right to access Music/audio devices
- down to access Setup features
- to the left to access Movie/video devices
- up to access Editing features

How Do I Enter Text?







Many of the control menus allow you to assign your own names to list items (such as radio stations, CD titles, etc.).

To enter text for names:

1. Access the control screen with the item name you want to change. You have accessed the appropriate screen if  or  appears on the screen.

2. Touch  or  :



- Use the stylus to select characters from the keyboard.
- Touch  to access to lowercase characters. Touch it again to access special characters (such as @, !, &, etc.). Touch it a third time to return to uppercase characters.
- Touch  or  to move back and forth between the characters.
- Touch  to clear the last character you entered. Touch  to delete all the characters in the line.
- Touch  to save your title then touch  to return to the previous menu.

Chapter Two: Using PowerTouch

Your new receiver comes with the easiest—and most innovative—remote you've ever seen. Its palm-sized illuminated screen displays clear icons and menus. Use the fingertip joystick to highlight your selection, then just press the joystick to activate. Because PowerTouch maintains two-way communication with your receiver, it shows the result of your action right on its screen.

This chapter contains the following sections:

How Do I Adjust the Sound?	page 10
How Do I Operate Devices?	page 26
Movie Devices	page 27
Music Devices	page 36
How Do I Record (Edit Mode)?	page 56
How Do I Adjust PowerTouch's Display?	page 60
How Do I Perform Several Actions at Once?	page 63

How Do I Adjust the Sound?

You can control and adjust a variety of sound settings using the receiver's front panel or PowerTouch.

Turning the Speakers On

To turn the Front A speakers on, press SPEAKER A on the receiver's front panel. The red light indicates that the speakers are on.

To turn the Front B speakers on, press SPEAKER B on the receiver's front panel. The red light indicates that the speakers are on.

If you select SPEAKER B while listening to a surround mode, the sound will automatically revert to stereo. If you manually select a surround mode while SPEAKER B is on, SPEAKER B will automatically shut off.

If you use speakers connected to amplifiers via the PRE OUT jacks, choose Front A speakers.

Adjusting the Volume

Use one of the following methods to adjust the volume.

- Turn the volume knob on the front panel of the receiver.

- Press  in the appropriate direction on PowerTouch.





Adjusting the Loudness (Stereo Mode Only)

The Loudness control increases the bass and treble at low volume control settings. This adjusts to the way the human ear hears sound at quiet volumes, retaining music's fullness and sparkle.

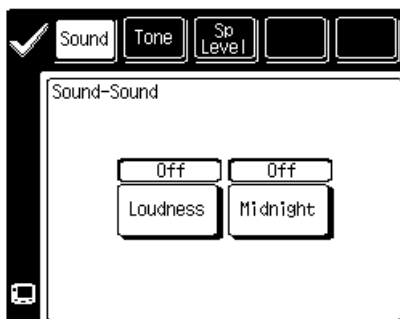
1. Touch  on the Quick Access menu to open the Sound menu:



2. Touch  to turn the loudness setting on or off.
3. Touch  to return to the previous menu or touch any Quick Access menu button to access that menu.

Adjusting the Tone (Stereo Mode Only)

Use the Sound menu to adjust the bass or treble tone of your front left and right speakers manually. In addition to setting bass and treble tone adjustment values, you can completely bypass the tone control circuitry for a purer sound.

How Do I Adjust the Sound?



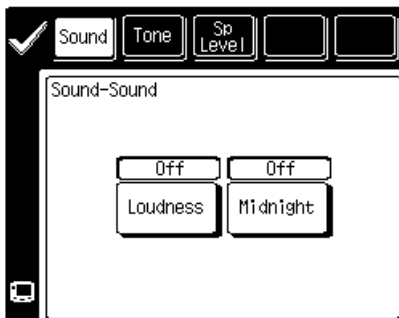

1. Touch  on the Quick Access menu to open the Sound menu:

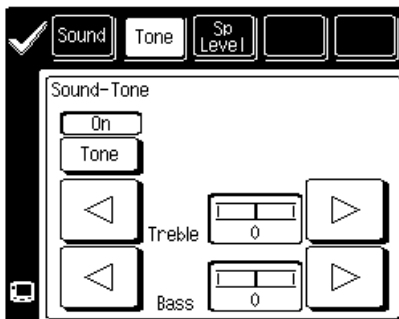

2. Touch  to open the Tone menu:



3. Touch  to turn the tone settings on or off.

4. Touch the left () or right arrow () next to a tone setting (treble or bass) to adjust it. A readout () between the arrows shows the current setting.
5. Touch  to return to the previous menu or touch any Quick Access menu button to access that menu.T

Adjusting Speaker Levels

You can use the Sound menu to temporarily adjust the speaker levels of your center speaker, surround speakers, and subwoofer. For example, if a particular movie has dialog that's hard to understand, you can temporarily increase the center channel volume just for that movie. For more information on adjusting speaker levels permanently, see Chapter Two: Setting Up PowerTouch in the *Connections and Setup Guide*.

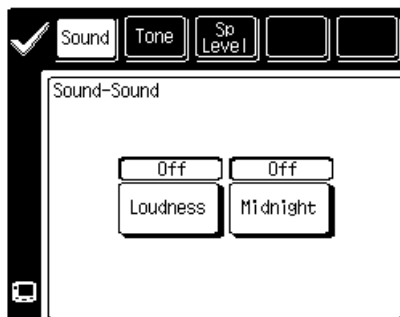

1. Touch  on the Quick Access menu to open the Sound menu:

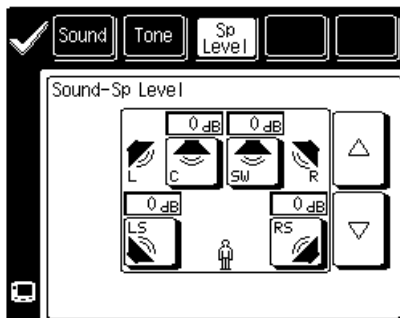

2. Touch  to open the SP Level menu:



Although icons for the front speakers appear here, notice that they do not have buttons. They're here for a visual reference; you cannot change their level.

3. Select a speaker by touching its button. You have selected a speaker when its button darkens.
4. Touch the up  or down arrow  to adjust the volume of the speaker you chose.
5. Touch  to return to the previous menu or touch any Quick Access menu button to access that menu.

These settings automatically return to the level you adjust on Chapter Two of *Connection and Setup Guide* whenever you select a different source device or turn the receiver's power off.

Muting Sound

Use one of the following methods to temporarily mute the sound:

- Press the Mute button on the receiver's front panel.
- Press  on PowerTouch.

A "Mute On" message appears on the LCD screen for 3 seconds, then disappears.

Use one of the following methods to cancel muting:

- Press either Mute button again.
- Adjust the volume control on either the receiver or PowerTouch.

A "Mute Off" message appears on the LCD screen for 3 seconds, then disappears.

Midnight Theatre Function



Any time you don't want to experience the loud and soft volume extremes of recorded sound (for example, late at night), use midnight theatre function to reduce volume extremes. This feature keeps loud, dramatic sound from being too loud (perhaps disturbing family members or neighbors) while ensuring that you can still hear whispered dialog or other soft sounds.

Midnight theatre function only works if you are listening to a Dolby Digital program that has been encoded with special compression data.

To balance volume extremes:

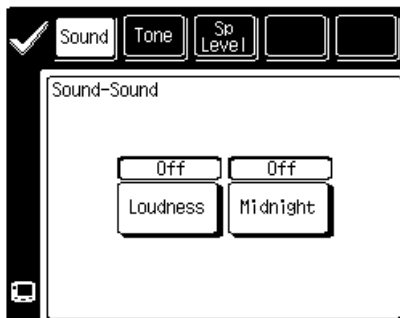
1. Touch  on the Quick Access menu to open the Sound menu:



2. Select  until the balancing sounds right to you:
 - OFF for normal balancing
 - 1 for quieter balancing
 - 2 for quietest balancing (the least difference between the loudest and quietest sound)
3. Touch  to return to the previous menu or touch any Quick Access menu button to access that menu.

What are Listen Modes?

You can experience true home-theater sound with your Kenwood Audio-Video Receiver. This receiver incorporates several listen modes to let you enjoy surround sound with a wide variety of program sources. Each produces multiple channels of surround-sound, but each does it differently.

How Do I Adjust the Sound?

- **Stereo:** Stereo listen mode provides standard stereo sound to the front left and right speakers.
- **Dolby 3 Stereo:** Use Dolby 3 Stereo for systems that do not have surround speakers. When in the Dolby 3 Stereo mode, surround information is redirected to the front left and right speakers. This mode is designed for use with Dolby Surround sources, but can also improve sound imaging and definition for programs that are not Dolby Surround encoded.
- **Dolby Pro Logic:** Dolby Pro Logic is a decoding process which provides theater-like surround sound from Dolby Surround encoded sources (such as videotape and LaserDisc software that are marked with the Dolby Surround logo). It offers excellent sound movement across the front of the room and a surround ambiance that seems to immerse you in a movie. Your receiver is equipped with a Dolby Pro Logic surround decoder to let you enjoy the wide variety of currently available Dolby Surround home video software.
- **DSP (Digital Signal Processing):** DSP allows you to create your own custom surround sound environments and use them with any source (except Dolby Digital and MPEG). You can select the ambience of an Arena, Jazz Club or Theater, and then modify the parameters to 'fine-tune' the environment to your taste. (See "Applying Digital Signal Processor (DSP) Effects" on page 22 for details about making DSP adjustments.)
- **Dolby Digital (AC-3):** Dolby Digital uses an encode/decode process based on its theatrical digital surround sound technology. The five main channels are full-frequency and independent, so sound can completely envelop you or soar anywhere in the room, just like at the movies.

Compared with Dolby Pro Logic, Dolby Digital has more clarity, greater surround envelopment, and more realistic sound movement between channels.

Although a full set of speakers (front left and right, center, surround left and right, and a subwoofer) is required for true Dolby Digital surround sound, this receiver lets you enjoy Dolby Digital program sources, even if you connect fewer speakers.

- **MPEG:** MPEG, which stands for "Moving Pictures Experts Group", is an international standard of digital video and audio compression and decompression in media. It is the most efficient encoding method for compressed multi-channel audio which provides the highest sound quality to deliver the best movie theater sound into the home.
- **THX:** Movie soundtracks are mixed in special movie theatres called dubbing stages and are designed to be played back in movie theatres with similar equipment and conditions. The soundtrack created for movie theatres is then transferred directly onto Laserdisc, VHS tape, DVD, etc., and is not changed for playback in a small home theatre environment.

THX engineers developed patented technologies to accurately translate the sound from the movie theatre environment into the home, correcting the tonal and spatial errors that occur. On the KRF-X9992D, when the THX mode is on, the THX technologies are automatically added after the decoded signal.

How Do I Adjust the Sound?

Your receiver can detect and switch between these formats automatically. To check the Surround Play status:

1. Touch  on the Quick Access menu to open the Listen Mode menu:

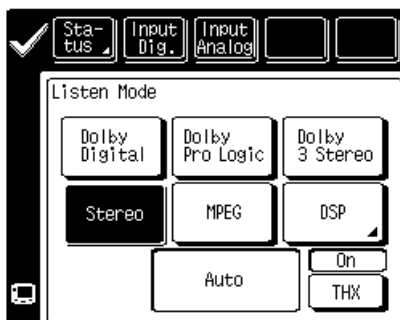

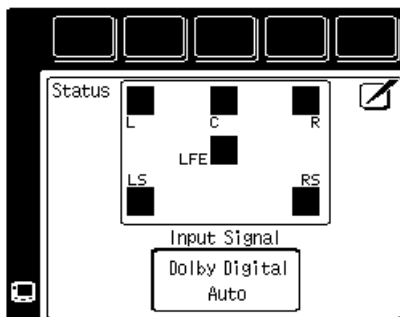

2. Touch . This displays the Input Sound Status screen, which shows the signal being displayed.



How Do I Adjust the Sound?

During Dolby Digital and MPEG playback, the program's encoded channel configuration is shown using the L, C, R, LS, RS, S and LFE icons.

3. Touch  to return to the Listen Mode menu.
4. Touch  to return to the previous menu or touch any Quick Access menu button to access that menu.

To set the listen mode manually:

1. Touch  on the Quick Access menu to open the Listen Mode menu:

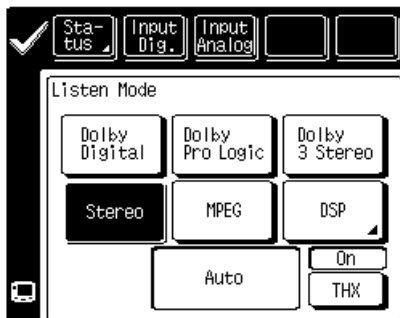

2. Touch  until "Manual" appears.
3. Select a listen mode.

NOTES

- The available surround modes may be restricted depending on the input signal. MPEG and Dolby Digital are only available if a MPEG or Dolby Digital signal is present at the digital input. For more information, see Chapter Three: Troubleshooting.

How Do I Adjust the Sound?

- If you turn off the receiver, select a different source device, or switch to the analog connections, the digital input mode is reset to “auto.”
- If the incoming signal is not Dolby Digital or MPEG, the listen mode reverts to the last listen mode you selected for that input.
- If the speakers are turned off (i.e., because you are listening on headphones), you cannot manually select Dolby Pro Logic or Dolby 3 Stereo.
- When you use “Digital Auto” mode with certain DVD and LD players, performing operations such as “Skip” or “Stop” may momentarily interrupt the output. This could switch the “Listen Mode” automatically to the surround mode intended for the input signal if you have manually selected a different listen mode.

Switching to Analog Input

To fully enjoy the sonic benefits of specially-encoded 2-channel DVD AUDIO discs played on a compatible DVD player, you must set the receiver’s input to Analog. To do so, select . “ANALOG” appears on the front panel of the receiver.

When you are finished listening to analog media, set the receiver’s input back to digital. To do so, select the  icon.

Applying Digital Signal Processor (DSP) Effects

The DSP mode creates the reverberation devices (elements of sound echoed in various spaces) which determine the feeling of presence. Since DSP uses digital processing, it can produce these effects without spoiling the sound quality of the original music or video source.

The DSP mode lets you add the atmosphere of an arena, jazz club or theater from any PCM or analog input source. These modes are particularly effective when used with stereo program sources like CD, television, and FM radio. You might enjoy trying the ARENA mode the next time you watch a sporting event or concert.

You can adjust the following elements to create a customized environment:

- The WALL TYPE parameter lets you adjust the brightness of the sonic environment according to your preference.
- The EFFECT level lets you adjust the amount of DSP “presence” in the sonic environment according to your preference.

To set a DSP effect:

1. Touch  on the Quick Access menu to open the Listen Mode menu:

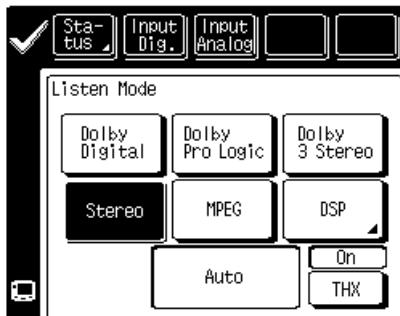

How Do I Adjust the Sound?

2. Touch  .

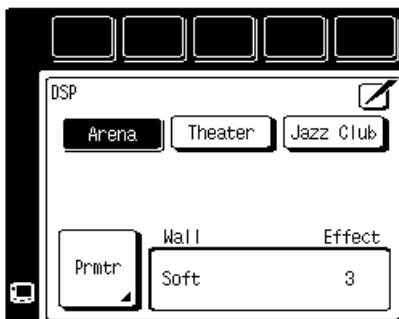

3. Touch a DSP mode icon button.

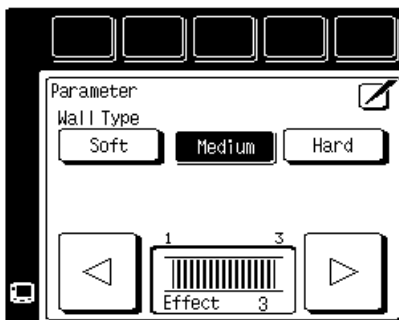

4. (Optional) Touch  (Parameter) to adjust the wall type and effect level to your taste.



5. Select the item to be adjusted:

- Wall Type changes the quality of the simulated walls.

How Do I Adjust the Sound?

- Effect Level adjusts the amount of DSP presence in the overall sound. Lower numbers decrease the amount of presence, higher numbers increase it.
6. Touch  to return to the DSP menu.
 7. Touch  to return to the Listen Mode menu.
 8. Touch  to return to the previous menu or touch any Quick Access menu button to access that menu.

Applying THX technologies

Movie soundtracks are mixed in special movie theatres called dubbing stages and are designed to be played back in movie theatres with similar equipment and conditions. The soundtrack created for movie theatres is then transferred directly onto Laserdisc, VHS tape, DVD, etc., and is not changed for playback in a small home theatre environment.

THX engineers developed patented technologies to accurately translate the sound from the movie theatre environment into the home, correcting the tonal and spatial errors that occur. On the KRF-X9992D, when the THX mode is on, the THX technologies are automatically added after the decoded signal.





Movies which have been encoded in Dolby Digital, MPEG, Dolby Pro Logic, Stereo and Mono can all benefit from activating the THX technologies. THX should be activated only when watching movies which were mixed for playback in large movie theatre environments. THX need not be activated for music, movies that were made especially for television or shows such as sports programming, talk shows, etc. This is because they were mixed in a small room environment.

How Do I Adjust the Sound?

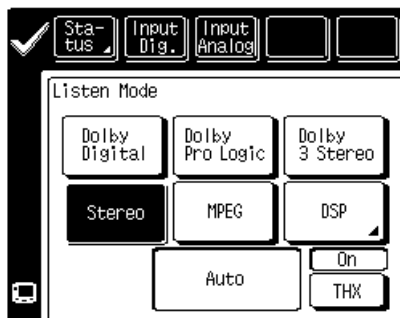
To set THX to on:

1. Touch  on the Quick Access menu to open the Listen Mode menu:



2. Touch  until "On" appears.
 -  : The receiver is in THX standby mode.
 -  : THX is activating. (THX will be activated automatically when in an effective surround mode.)
3. Touch  to return to the previous menu or touch any Quick Access menu button to access that menu.

What if I Want to Use Headphones?

Insert your headphone jack into the receiver jack. Adjust the sound as described earlier in this chapter.



If you want to listen to a Dolby Digital or MPEG program through headphones, switch the speaker selectors off.

How Do I Operate Devices?

Your PowerTouch makes it easy for you to control the different devices connected to your receiver. Its easy-to-use LCD screen provides a choice of command buttons similar to those found on the devices' own remotes. Use these buttons to control your home entertainment equipment by following these easy steps:







1. Choose the menu containing the device you want to use (Movie or Music).
2. Touch the icon button for the device you want to operate from PowerTouch's control screen.
3. Touch a button on the device's control screen.

The rest of this manual assumes that you have connected your home entertainment devices and identified those devices to PowerTouch. **If you have not done so, follow the instructions under "Identifying Devices For PowerTouch Control" on page 37 of the *Connections and Setup Guide* before reading any further in this manual.** If you do not, you will not see controls for any device except for the factory-defined devices, such as the tuner.

As you use PowerTouch, remember that this manual only gives instructions for operating PowerTouch with a particular device. It is not intended to explain how your devices work—for that information see the manuals that came with your devices.

Movie Devices

Use this menu to operate devices that provide video, such as DVD players, VCRs, etc. This menu controls the following (note which device you have connected to the jack in the space provided):

I should use this button	to control this device... (use this space to note your devices, The device icons will also appear in the button after you identify a device for it)
	
	
	
	
	
	

TV

To operate a standard TV:

1. Touch  on the main or Quick Access menu.
2. Touch the TV icon button to which you assigned the TV. This accesses the TV controls:

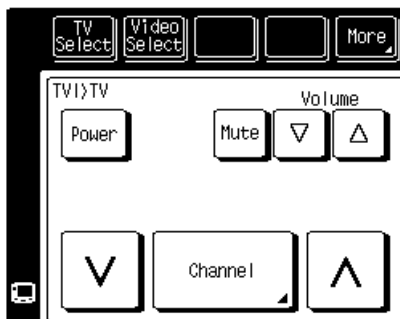

3. Use this screen as your TV remote. The available buttons may vary depending on the setup code you assigned to this icon.

Touch  to access any customized commands you have taught PowerTouch for this device and to access this device's macros. Touch the command or macro name to use it.

For more information on teaching commands to PowerTouch, see "What if my device does not work with any of the codes on the list? What if I Want PowerTouch to Control Additional Functions?" on page 39 of the *Connections and Setup Guide*. For more information on device macros, see "How Do I Perform Several Actions at Once?" on page 63 of this manual.

4. Touch  on Quick Access menu to return to the Movie menu.

To operate satellite TV:

1. Touch  on the main or Quick Access menu.
2. Press the Video icon button to which you assigned the satellite TV receiver. This accesses the satellite controls:

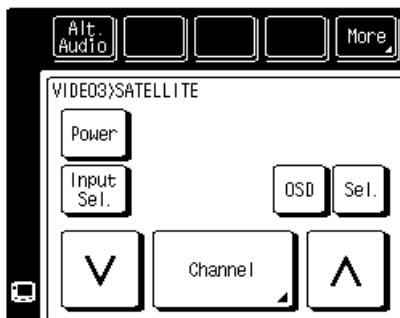

3. Use one of these screens as your satellite TV remote (depending on the service you receive). The available buttons may vary depending on the setup code you assigned to this icon.

Touch  to access any customized commands you have taught PowerTouch for this device and to access this device's macros. Touch the command or macro name to use it.

How Do I Operate Devices?

For more information on teaching commands to PowerTouch, see “What if my device does not work with any of the codes on the list? What if I Want PowerTouch to Control Additional Functions?” on page 39 of the *Connections and Setup Guide*. For more information on device macros, see “How Do I Perform Several Actions at Once?” on page 63 of this manual.

4. Touch  on Quick Access menu to return to the Movie menu.

To operate cable TV:

1. Touch  on the main or Quick Access menu.
2. Touch the TV or input icon button to which you assigned the cable TV tuner. This accesses the cable TV controls:

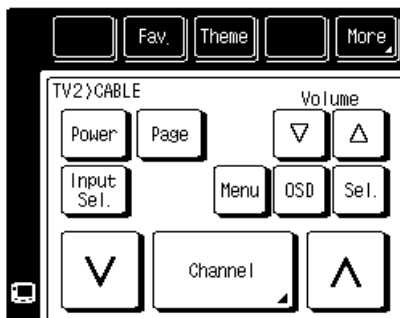

3. Use this screen as your cable TV remote. The available buttons may vary depending on the setup code you assigned to this icon.

Touch  to access any customized commands you have taught PowerTouch for this device and to access this device's macros. Touch the command or macro name to use it.

For more information on teaching commands to PowerTouch, see "What if my device does not work with any of the codes on the list? What if I Want PowerTouch to Control Additional Functions?" on page 39 of the *Connections and Setup Guide*. For more information on device macros, see "How Do I Perform Several Actions at Once?" on page 63 of this manual.

4. Touch  on Quick Access menu to return to the Movie menu.

VCR

To operate the VCR:

1. Touch  on the main or Quick Access menu.
2. Touch the Video icon to which you assigned the VCR. This accesses the VCR controls:

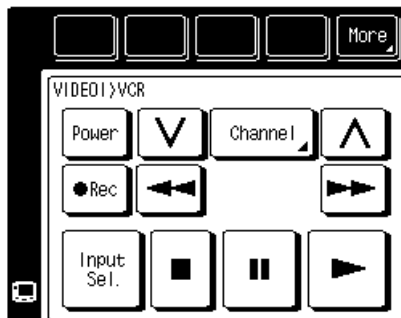

How Do I Operate Devices?

3. Use this screen as your VCR remote. The available buttons may vary depending on the setup code you assigned to this icon.

Touch  to access any customized commands you have taught PowerTouch for this device and to access this device's macros. Touch the command or macro name to use it.

For more information on teaching commands to PowerTouch, see "What if my device does not work with any of the codes on the list? What if I Want PowerTouch to Control Additional Functions?" on page 39 of the *Connections and Setup Guide*. For more information on device macros, see "How Do I Perform Several Actions at Once?" on page 63 of this manual.

4. Touch  on Quick Access menu to return to the Movie menu.

DVD Player

1. Touch  on the main or Quick Access menu.
2. Select the icon you assigned to your DVD player. This accesses the DVD controls:

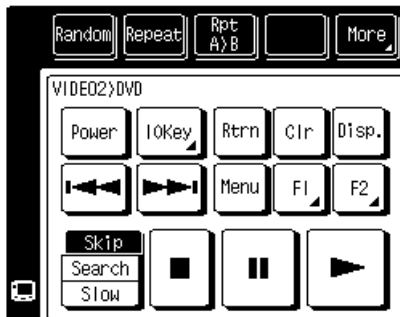

3. Use this screen as your DVD player remote. The available buttons may vary depending on the setup code you assigned to this icon.

Touch  to access any customized commands you have taught PowerTouch for this device and to access this device's macros. Touch the command or macro name to use it.

For more information on teaching commands to PowerTouch, see "What if my device does not work with any of the codes on the list? What if I Want PowerTouch to Control Additional Functions?" on page 39 of the *Connections and Setup Guide*. For more information on device macros, see "How Do I Perform Several Actions at Once?" on page 63 of this manual.

4. Touch  on Quick Access menu to return to the Movie menu.

How Do I Operate Devices?

If you are listening to a DVD AUDIO music disc in analog mode, you will need to switch the input from Digital Input to Analog Input. For more information on switching input, see “Switching to Analog Input” on page 21.

Laser Disc Player

To operate a laser disc player:

1. Touch  on the main or Quick Access menu.
2. Select the icon you assigned to the laser disc player. This accesses the laser disc controls:

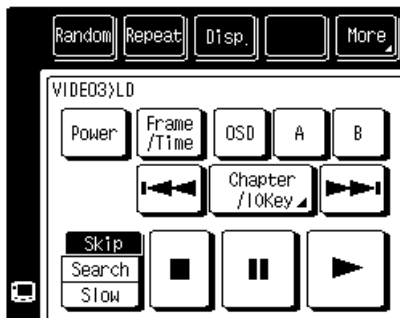

3. Use this screen as your laser disc player remote. The available buttons may vary depending on the setup code you assigned to this icon.

Touch  to access any customized commands you have taught PowerTouch for this device and to access this device's macros. Touch the command or macro name to use it.



How Do I Operate Devices?

For more information on teaching commands to PowerTouch, see “What if my device does not work with any of the codes on the list? What if I Want PowerTouch to Control Additional Functions?” on page 39 of the *Connections and Setup Guide*. For more information on device macros, see “How Do I Perform Several Actions at Once?” on page 63 of this manual.

4. Touch  on Quick Access menu to return to the Movie menu.

Camcorder or Additional VCR

To operate auxiliary video input (e.g., a camcorder or a VCR):

1. Touch  on the main or Quick Access menu.
2. Touch  to set the camcorder or VCR as the input source.
3. Play your camcorder or VCR as normal. Please note that you cannot control these components with PowerTouch; you must still operate them manually.

Music Devices

Use this menu to operate devices that provide audio only, such as CD players, the tuner, etc. This menu controls the following (note which device you have connected to the jack in the space provided):

I should use
this icon...



to control this device...
(use this space to note your devices)



Kenwood 200-Disc CD Changer

Kenwood 200-Disc CD Changers have many different features that make them ideal complements to your Kenwood receiver. Some changer models can store disc and track titles for all loaded discs, and then download this information to your receiver for display on PowerTouch's screen. You can easily activate all these features using just a few of PowerTouch's buttons.

To play CDs using PowerTouch:

1. Touch  on the main or Quick Access menu.
2. Touch . This accesses the CD controls:

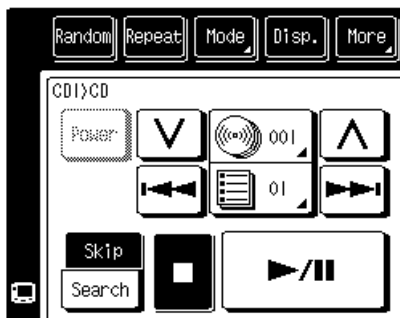

3. Use this screen as your CD remote.

Touch  to access any customized commands you have taught PowerTouch for this device and to access this device's macros. Touch the command or macro name to use it.

For more information on teaching commands to PowerTouch, see "What if my device does not work with any of the codes on the list? What if I Want PowerTouch to Control Additional Functions?" on page 39 of the *Connections and Setup Guide*. For more information on device macros, see "How Do I Perform Several Actions at Once?" on page 63 of this manual.

4. Touch  on Quick Access menu to return to the Music menu.



Displaying Disc and Track Titles

Kenwood 200-Disc CD Changers allow you to easily search for and select a particular CD or song by title from any disc you've loaded into the unit. PowerTouch can display these disc and track titles on its LCD display, allowing you to choose discs and songs by title in a few simple steps.



You have to assign disc and track titles to the discs in your CD player before you can transfer them to PowerTouch. See your CD player's instruction manual for more information about assigning disc and track titles.

To read the loaded disc titles and store them in PowerTouch:

1. Touch  on the main or Quick Access menu.
2. Touch  .
3. Touch  . This accesses the disc mode commands:

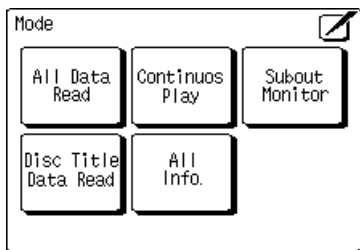



4. If you haven't already done so on the CD changer, touch



. This reads all of the disc and track title information into the CD changer's memory.

5. Set PowerTouch down so that its IR transmitter window is aiming at the receiver's IR transmitter window. Select . **Do not** move PowerTouch while it is reading data.

This process may take some time, depending on how many CDs you have loaded. When the IR light on the receiver goes out, the receiver is done sending the information to PowerTouch, and you may move PowerTouch again. PowerTouch's memory now contains the disc titles of every CD in the changer with title information.

6. Touch  to return to the CD controls.
7. Touch  on Quick Access menu to return to the Music menu.

To read the loaded track titles and store them in PowerTouch:

1. Make sure you have followed the previous instructions to read disc data.





2. Touch  on the main or Quick Access menu.

3. Touch .

4. If you haven't already done so on the CD changer, touch







. This reads all of the disc and track title information into the CD changer's memory. Touch  to return to the CD controls.

5. Select the disc you want to play and touch  to open the track controls.
6. Set PowerTouch down so that its IR transmitter window is aiming at the receiver's IR transmitter window. Touch . **Do not** move PowerTouch while it is reading data.
This process may take some time, depending on how many CDs you have loaded. You will see the track titles on the PowerTouch when it is finished reading data.
7. Touch  to return to the CD controls.
8. Touch  on Quick Access menu to return to the Music menu.



Entering Disc and Track Titles: You can also use PowerTouch to enter disc or track titles, if they are not already stored on the changer. The titles you add are stored in memory on both PowerTouch and the changer.

To enter disc or track titles:

1. Touch  on the main or Quick Access menu.
2. Touch .
3. Stop playing a CD. (if it is playing)
4. Touch  or . This accesses the appropriate control commands.

If you pressed , you will be entering track titles for the currently selected disc.

How Do I Operate Devices?



5. Touch the disc or track name you want to change. See "How Do I Enter Text" on page 7 for more information on changing names.
6. Press .
7. Repeat steps 5 and 6 for each title you want to store.
8. Touch  to return to the disc or track controls. Touch it again to return to the CD controls.
9. Touch  on Quick Access menu to return to the Music menu.

NOTES

If you rearrange or add new CDs to the changer, you will need to repeat both the disc and track read process. Otherwise, disc information is stored in PowerTouch permanently.







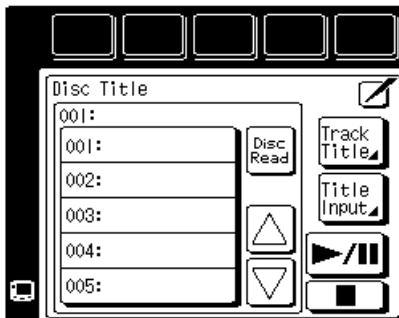

The track title information is not stored permanently in PowerTouch. Each time you select a CD to play you have to download its track title information.

To play discs and tracks by title:

1. Touch  on the main or Quick Access menu.
2. Touch .

3. Touch . This accesses the disc commands:





4. Titles of all discs in the changer are displayed in numerical order.
5. Use the up () or down arrow () to scroll through the discs numerically, then touch the disc title you want to play.
6. If you want to play the disc from the beginning, touch .
7. (Optional) Touch . The track titles for that disc are displayed in numerical order.
8. If you want to play the disc starting from a particular track, use the up () or down arrow () to scroll through the track titles, then touch the track title.
9. When you've highlighted the track you want to begin playing, touch .
10. Touch  to return to the CD controls.

11. Touch  on Quick Access menu to return to the Music menu.

Single or Rotary CD Player

To operate a single CD player:

1. Touch  on the main or Quick Access menu.
2. Touch . This accesses the CD controls:

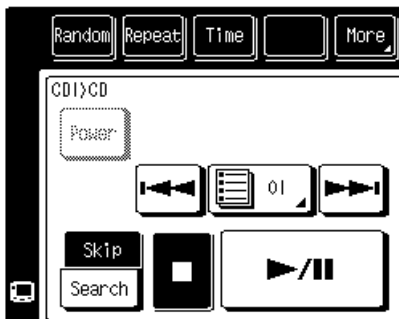

3. Use this screen as your CD player remote. The available buttons may vary depending on the setup code you assigned to this icon.



Touch  to access any customized commands you have taught PowerTouch for this device and to access this device's macros. Touch the command or macro name to use it.

How Do I Operate Devices?

For more information on teaching commands to PowerTouch, see “What if my device does not work with any of the codes on the list? What if I Want PowerTouch to Control Additional Functions?” on page 39 of the *Connections and Setup Guide*. For more information on device macros, see “How Do I Perform Several Actions at Once?” on page 63 of this manual.

4. Touch  on Quick Access menu to return to the Music menu.

To operate rotary CD players:

1. Touch  on the main or Quick Access menu.
2. Touch . This accesses the CD controls:

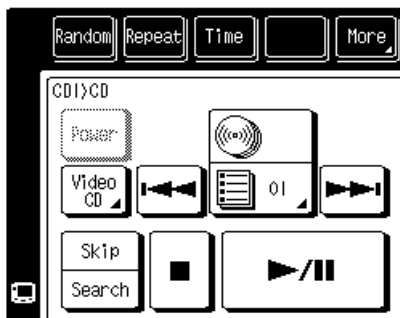



3. Use this screen as your CD player remote. The available buttons may vary depending on the setup code you assigned to this icon.

Touch  to access any customized commands you have taught PowerTouch for this device and to access this device's macros. Touch the command or macro name to use it.

For more information on teaching commands to PowerTouch, see "What if my device does not work with any of the codes on the list? What if I Want PowerTouch to Control Additional Functions?" on page 39 of the *Connections and Setup Guide*. For more information on device macros, see "How Do I Perform Several Actions at Once?" on page 63 of this manual.



4. Touch  on Quick Access menu to return to the Music menu.

To play Video CDs (if your CD player supports the Video CD format):

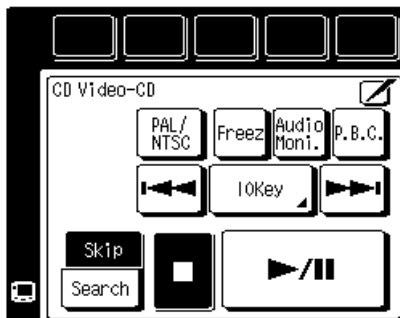
1. Touch  on the main or Quick Access menu.
2. Touch .
3. Touch the Video CD button. This accesses the Video CD controls:





How Do I Operate Devices?

- Use this screen as your Video CD player remote. The available buttons may vary depending on the setup code you assigned to this icon.
- Touch  to return to the CD controls.
- Touch  on Quick Access menu to return to the Music menu.

MD Recorder or Tape Deck

To operate an MD recorder:

- Touch  on the main or Quick Access menu.
- Touch . This accesses the MD recorder controls:

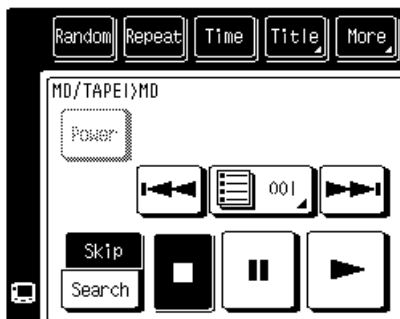

- Use this screen as your MD recorder remote. The available buttons may vary depending on the setup code you assigned to this icon.









Touch  to access any customized commands you have taught PowerTouch for this device and to access this device's macros. Touch the command or macro name to use it.

For more information on teaching commands to PowerTouch, see “What if my device does not work with any of the codes on the list? What if I Want PowerTouch to Control Additional Functions?” on page 39 of the *Connections and Setup Guide*. For more information on device macros, see “How Do I Perform Several Actions at Once?” on page 63 of this manual.

4. Touch  on Quick Access menu to return to the Music menu.



Entering Disc and Track Titles: If you have Kenwood DMF-7020 or DMF-9020, you can also use PowerTouch to enter disc or track titles.

To enter disc or track titles:

1. Touch  on the main or Quick Access menu.
2. Touch  .
3. Stop playing an MD. (if it is playing)
4. Touch  .
5. See “How Do I Enter Text” on page 7 and enter a title.
6. Press  .
7. While watching the MD recorder’s display, use  or  on the Mini Disc Title menu to select where you want to enter the title to (either disc title or track title). If you want to enter a track title, choose the track number you want to assign a name for.
8. Press  .
9. Press  to return to MD controls.

10. Touch  on Quick Access menu to return to the Music menu.

To operate a Tape Deck:

1. Touch  on the main or Quick Access menu.
2. Touch . This accesses the tape deck controls:

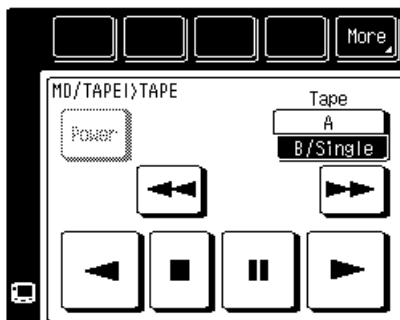

3. Use this screen as your tape deck remote. The available buttons may vary depending on the setup code you assigned to this icon.

Touch  to access any customized commands you have taught PowerTouch for this device and to access this device's macros. Touch the command or macro name to use it.



For more information on teaching commands to PowerTouch, see "What if my device does not work with any of the codes on the list? What if I Want PowerTouch to Control Additional Functions?" on page 39 of the *Connections and Setup Guide*. For more information on device macros, see "How Do I Perform Several Actions at Once?" on page 63 of this manual.

4. Touch  on Quick Access menu to return to the Music menu.

See your cassette deck instruction manual for more information.



Turntable

To operate a turntable/record player:

1. Touch  on the main or Quick Access menu.
2. Touch  to set the turntable as the speaker source. You will remain at the Music menu.
3. Play your records as normal. Please note that you cannot control the turntable with PowerTouch; you must still operate the turntable manually.

Second CD Player or Tape Deck

To operate a second CD player or tape deck:

1. Touch  on the main or Quick Access menu.
2. Touch . The commands appear for the device you connected to this jack set and identified to PowerTouch.
3. Use the available commands as your CD player or tape deck remote.



Touch  to access any customized commands you have taught PowerTouch for this device. Touch the command to use it.

For more information on teaching commands to PowerTouch, see "What if my device does not work with any of the codes on the list? What if I Want PowerTouch to Control Additional Functions?" on page 39 of the *Connections and Setup Guide*.

4. Touch  on Quick Access menu to return to the Music menu.

Tuner





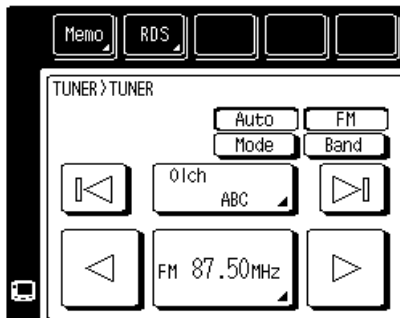





To tune in to a radio station:

1. Touch  on the main or Quick Access menu.
2. Touch . This accesses the tuner commands:



3. Tune in the station:
 - Touch  to change bands.

How Do I Operate Devices?

- Touch  to switch from Auto tuning to Manual tuning. Select Manual if you experience interference due to weak radio signals. (Stations are received in mono during manual tuning.)
 - Touch the left  or right arrow  to tune in a station.
 - Touch  and enter the broadcast frequency using the 10key pad. (e.g.; To select FM 108.0 MHz, enter 1, 0, 8, 0, 0, and )
 - Select the left  or right end arrow  to cycle through any stations stored in memory. For more information on storing stations in memory, see “Storing Radio Stations in Memory (optional)” on page 40 of the *Connections and Setup Guide*.
 - Touch  to open the stored stations list. Touch a storage button and touch  to tune that station.
4. Touch  on Quick Access menu to return to the Music menu.

RDS (Radio Data System): RDS (Radio Data System) is a system where radio stations transmit digital data for FM broadcasts along with the broadcast signal. Tuners and receivers designed for RDS reception can extract the data from the broadcast signal for use with various functions such as automatic display of the station name.

RDS Functions help you:

- Search for programs of a specific type using Program Type Identification Search (PTY search).



How Do I Operate Devices?

- View information about a station:
 - the station name
 - any text data transmitted by the station
- Automatically select stations providing RDS and FM broadcasting and store them in the preset memory (up to 40 stations can be preset). For more information about storing stations, see “Storing Radio Stations in Memory (optional)” on page 40 of the *Connections and Setup Guide*.



NOTES

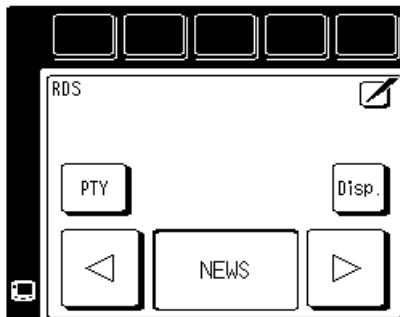

Before using RDS functions, be sure to perform “Storing RDS Stations Automatically” on page 40 of the *Connections and Setup Guide*.

To search for a specific type of music or radio program:

1. Touch  on the main or Quick Access menu.
2. Touch .
3. Touch  at the top of the screen. This accesses RDS commands:



4. Touch .
5. While  is highlighted, select the program type you want using one of the following methods:

- Select the left () or right arrow () to cycle through the program types until the type you want appears. The program types cycle in the order shown in the table below.

Program Type Name	Receiver Display
Pop Music	POP M
Rock Music	ROCK M
Easy Music	EASY M
Light Classical Music	LIGHT M
Serious Classical Music	CLASSICS
Other Music	OTHER M
Weather	WEATHER
Finance	FINANCE
Children's programmes	CHILDREN
Social affaires	SOCIAL
Religion	RELIGION
Phone in	PHONE IN

Program Type Name	Receiver Display
Travel	TRAVEL
Leisure	LEISURE
Jazz Music	JAZZ
Country Music	COUNTRY
National Music	NATION M
Oldies Music	OLDIES
Folk Music	FOLK M
Documentary	DUCUMENT
News	NEWS
Current Affairs	AFFAIRS
Information	INFO
Sports	SPORT
Education	EDUCATE
Drama	DRAMA
Cultures	CULTURE
Science	SCIENCE
Varied Speech	VARIED

6. Touch .

- If the tuner cannot find the program type you want, "NO PROGRAM" appears on the receiver display. The display returns to its original screen after several seconds.
- If the tuner locates a station playing the program type you want, reception begins. The display changes to show the station name.

To change to a different program type, repeat Steps 4 through 6 above.

To cancel the program search, touch  during the PTY search.

How Do I Record (Edit Mode)?

How Do I Record (Edit Mode)?

PowerTouch provides a simple yet powerful editing procedure that lets you quickly and easily specify the source and destination devices.

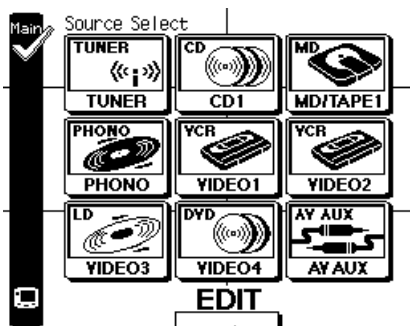

To record:

1. Touch  on the main or Quick Access menu to open the Edit menu:

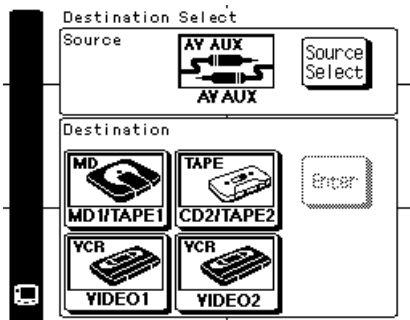

2. Touch a source device. This will be the device you are recording *from*, like a DVD or CD player. PowerTouch displays the destinations able to record from that source:



3. Touch a destination device, then touch . PowerTouch displays the control screen for the destination device, with two additional buttons on the left-hand side:
 - a. Touch  (Source) to switch to the control screen for the source device and get it ready to play.
 - b. Touch  (Destination) to switch to the control screen for the destination device and get it ready to record.
4. Touch the record control on the destination device, then switch to the source device and touch the play control.
5. Touch any Quick Access button to change to that menu.

How Do I Record (Edit Mode)?

For more information on recording with any connected device, see the device's instruction manual.

Here are some helpful hints for recording:

- If you're recording from a digital source, select the source device, then set the listen mode to Stereo (Touch ). Home VCRs can only place 2 channels of sound on a tape, and this enables the receiver to "downmix" from Dolby Digital or MPEG multi-channel sound down to 2 channels. For more information on setting listen modes, see "To set the listen mode manually" on page 20.
- If you're recording from a digital source, any action other than adjusting the volume may cause the sound to "clip" on the recording.
- You cannot record from the component you are using to record. For example, if you're recording on a VCR connected to the VIDEO1 jacks, select a source other than Video 1.
- If your source is a camcorder or other video unit, refer to the instruction manual for the particular unit you're recording from.



Digital to Digital Recording:

The PCM digital signal input through any DIGITAL IN jack is output digitally at the optical jack. Be sure you have connected a cable from the OPTICAL (DIGITAL OUT) jack on the receiver to the MD recorder's digital input. For more information on this connection, see "Connecting Your MD Recorder or Primary Tape Deck" on page 20 of the *Connections and Setup Guide*.

Dolby Digital and MPEG signals cannot be recorded.

Digital to Analog Recording:

Analog audio tape can only contain 2 channels of sound. Your receiver can “downmix” from Dolby Digital or MPEG 5.1-channel sound down to 2 channels. You can manually set the listen mode to enable this downmixing. For more information on setting listen modes, see “To set the listen mode manually” on page 20.

You can also do this procedure automatically by selecting AUTO REC MODE with DISPLAY MODE key on the front panel of the receiver. Press the DISPLAY MODE key for more than 2 second and select it. If the sound is cut or interrupted using AUTO REC MODE, try MANUAL REC MODE. (When you want to select MANUAL REC MODE, play the music first, and then select the mode in the same way. If no sound is heard, press the DISPLAY MODE key once.)

How Do I Adjust PowerTouch's Display?

How Do I See PowerTouch in the Dark?

You can use your PowerTouch in the dark. When you turn on the back light, your PowerTouch screen will light up, making navigation easier if you need to operate PowerTouch in dim or nonexistent light.

To use PowerTouch in the dark, press .

To turn off the light and return to normal display, press  again.

Backlight is automatically turned off when PowerTouch goes to "sleep"—you will need to turn it on again when you reactivate PowerTouch.

NOTES

Keep the Back Light turned off during normal use to maximize the life of your batteries.

How Do I See PowerTouch's Screen More Clearly?

You can also adjust the contrast to suit your viewing angle.

To adjust the contrast:

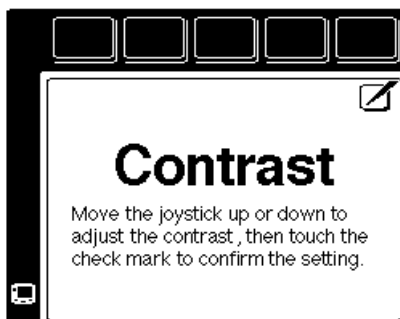

1. Press  until "Contrast" message appears on the screen:



2. While this message is displayed, move the joystick up or down to increase or decrease the contrast until you are satisfied.
3. Touch  to save the contrast setting and return to the control screen.

How Do I Turn the Beeping On or Off?

PowerTouch emits beeps under various circumstances (for example, to confirm your entry). You can turn these sounds off if you don't want to hear them. To turn the beeps off:

1. Touch  on the main menu then touch .
2. Touch  once to turn off beeping. Touch it again to turn beeping back on.

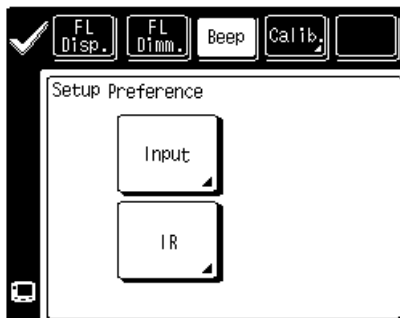

Using PowerTouch to Dim or Brighten the Receiver's Front Panel

1. Touch  on the main menu then touch .



2. Touch  until the brightness is adjusted as you want.

Changing the Front Panel Display Mode

1. Touch  on the main menu then touch .
2. Touch  until the display mode that you want appears.

A: Connected Device

DVD

B: Input Terminal

Video 4

C: Listen Mode

Dolby Digital

Input Type

DGTL

Connected Device

DVD

How Do I Perform Several Actions at Once?

PowerTouch uses sophisticated processing to make it easy for you to perform several actions at once using the Macro menu. Once you create the macros, specifying which devices should receive which commands at what interval, a single touch can lower curtains, dim lights, and turn on and start devices.

There are a number of macros automatically associated with each device. These macros will appear on the “More” screen for the device. Although you can assign any set of actions to a macro, the macro’s association will not change. Each device input supports up to 6 macros.

These macros enable you to group multiple actions onto a single button. For example:

- You could create a macro to access a specific TV station—like setting a button on the radio in your car. You would most likely choose a macro associated with your TV, or one with the jack set to which you connected your cable or satellite receiver. You would then define a macro that entered the channel number for that station.
- You could create a macro to change video input and start a tape in your VCR. You would most likely choose a macro associated with your TV or with the video jack to which you connected your VCR. You would then define a macro that:
 - changes the TV station to channel 3
 - turns on the VCR
 - delays 1 second to allow the VCR to power up
 - switches the TV input to VCR
 - starts the tape playing

Creating Macros

PowerTouch provides a simple way to create macros:

1. Think about the sequence of events you want to set up. You may even want to note down which devices should turn on first and how much time you think should pass between each step.

2. Touch  on the main menu then touch .

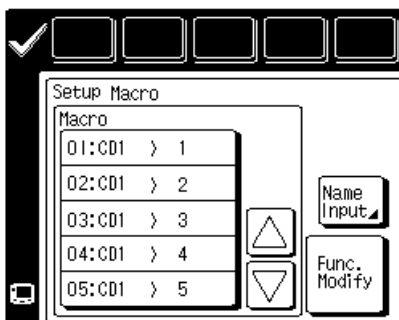

3. Figure out what device you will be using when you want to run the macro and select a macro line associated with that device.

4. Touch . Enter a name for the macro. See "How Do I Enter Text?" on page 7 for more information on entering names.

5. Touch :

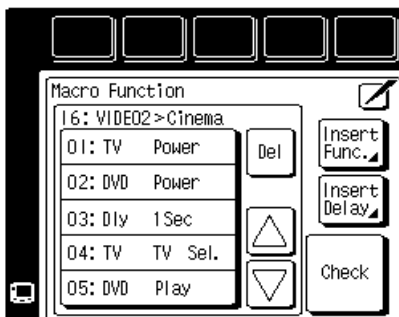

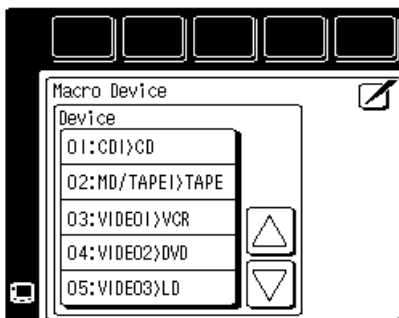

6. Touch a blank space (blank macro function line).

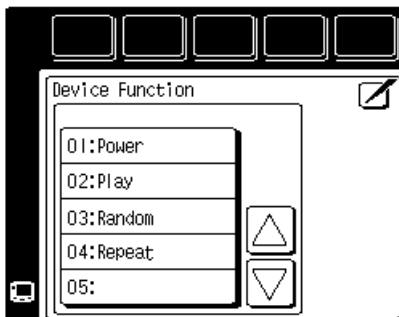

7. Touch a device, then touch an available function:





PowerTouch inserts the function then returns you to the Macro Device menu.

8. Repeat step 7 to insert all the devices and functions you want to use.
9. Touch  to return to the Macro Function menu.
10. Touch  to test the macro.
11. If some of the functions did not occur, you need to insert delay before these functions. To insert a delay (which is stored on its own line as a separate action):
 - a. Touch the device line whose function did not occur.

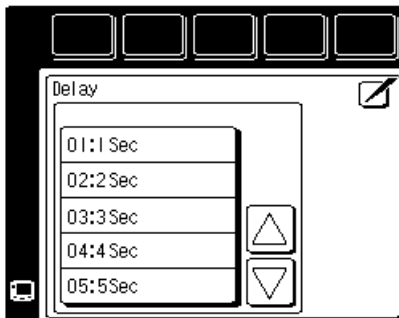
- b. Touch .



- c. Touch a delay time. PowerTouch inserts the delay then returns you to the Macro Function menu.
- d. Repeat a. through c. for other functions.
12. (Optional) To delete a function:
- a. Touch a macro function line you want to delete.
- b. Verify that this is the correct function. Touch .
- (Optional) To insert a function:
- a. Touch a macro function line where you want to insert a function, then touch .
- b. Touch a device, then touch an available function.
13. Repeat steps 7 through 9 until you have defined all the actions necessary for this macro.

14. Aim PowerTouch at the appropriate device and touch  to test the macro. Do not move PowerTouch or walk in front of the transmitter while it is checking the macro.

15. Touch  to return to the Setup Macro menu.

16. Touch a Quick Access button to return to the Music or Movie menu.

Using Macros

Once you have defined macros, you can use them directly from the Quick Access menu for one-touch operation of several devices.



There are two ways to use the macros you defined:

- from the Macro Summary menu, which displays all the available macros
- from the More screen for each device, which displays the macros associated with that device

To run a macro from the Macro Summary menu:

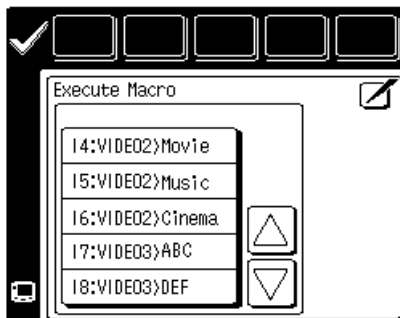
1. Touch  on the Quick Access menu to access the Macro menu.



2. Touch a macro line. If the macro you want is not displayed, use the up () or down arrow () to scroll through the list until you see it.
3. Touch  to return to the previous menu.

To run a macro from a device's "More" screen:

1. Follow the steps under the device name in this chapter to access the controls for that device.
2. Touch .
3. Choose the macro from the list on the right side of the screen.

Chapter Three: Troubleshooting

Troubleshooting is how you determine what part of a complex system (like a home theater system) is at fault when the system isn't working how you think it should. When you troubleshoot a system, you diagnose a problem by examining and eliminating possible causes until there's only one left. Troubleshooting is easiest when you start with the most obvious, most common, and most likely and work from there.

Diagnosing your own problems can save you time and aggravation—the better you understand how to troubleshoot and adjust your own system, the less time you have to:

- spend on the phone with a customer service representative
- do without your receiver because it's "in the shop"

There are some basic steps to good troubleshooting:

1. **Verify the exact conditions when the problem occurs.**

This is the most important step in troubleshooting. Whether you fix it yourself or have to describe it to a technician, you are much more likely to really solve the problem if you know the exact circumstances surrounding the problem. For example, if you don't hear anything through the speakers, it's useful to know if it only happens when you are listening to CDs.

Knowing that eliminates the speakers themselves as part of the problem. The more you know about when a problem occurs, the more likely it is that you or the technician can solve it.

2. **Check each part of the signal's path from source (such as a CD player) to speaker.**

You may also want to test the assumptions you made in step 1: maybe you haven't listened to your MD recorder in a while— is there no sound from it as well? This step will really help narrow down the possible causes. Test all your connected devices and eliminate the ones where the problem doesn't occur. When you're done with this step, you'll

probably have found the problem.

3. Go over all device connections slowly and methodically. Double-check the settings on your remote.

Wrong or loose connections are the most likely cause of the most common home entertainment problem: no sound. Use the *Connection and Setup Guide* to double-check your connections for each device. This is especially important with VCRs, tape decks, MD recorders, and equalizers, where it's very easy to swap the "play" and "record" connections.

You should also check your PowerTouch settings carefully. Did you set the input to the correct device? (you can also check the front panel of the receiver) Are you trying to listen to an analog source using a digital connection?

4. Cables (especially old ones) go bad more frequently than devices do.

Always suspect the cable before its device. For one thing, it's easier to test: simply swap the cable with one connected to a device you know *is* working. If the problem device works now, it was the cable. You can generally purchase new cables at most home electronics stores, or via the Internet.

5. User error is more likely than device failure.

You probably don't want to hear this, but it's true. Use this manual to go over the steps to operate the receiver. Refer to the other devices' manuals as well.

6. Instruction manuals are your friend.

A good rule of thumb is to check the manual when something doesn't work how you expected it to. If you read the manual before calling the store or taking the device back, you may find the solution to your problem much more quickly.

The rest of this chapter presents some common problems, grouped by type, and the steps you can take to resolve them.

Sound

I don't hear any sound at all

Check that:

- The volume is set at the proper level. See "Adjusting the Volume" on page 10 of this manual.
- Mute is OFF. If the MUTE indicator on the front of the receiver is blinking, MUTE is ON. See "Muting Sound" on page 15 of this manual.
- The proper input (e.g., CD player, Tuner, etc.) has been selected on the PowerTouch. See "How Do I Operate Devices?" on page 26 of this manual.
- The CD2/Tape2 monitor input has not been selected. (If it has, the CD2/Tape2 monitor indicator on the receiver's front panel will be lit). See "What's on the Front Panel of Your Kenwood Audio - Video Receiver?" on page 2 of this manual.
- The input mode matches the input signal (e.g., analog vs. digital) that has been set. See "Switching to Analog Input" on page 21 of this manual.
- The correct Listen Mode (e.g., Auto) has been set for the digital input. See "What are Listen Modes?" on page 16.
- The correct speakers have been activated. See "Turning the Speakers On" on page 10 of this manual.

I can't hear sound from one or more of the speakers, or the sound is abnormally low

Check that:

- All of the speaker wires are connected tightly, not short circuited. See Chapter One of the *Connections and Setup Guide*.
- All of the speakers have been activated in the Setup Speakers menu. See Chapter Two of the *Connections and Setup Guide*.

- The individual speaker levels are set properly. See Chapter Two of the *Connections and Setup Guide*.
- The CD2/Tape2 monitor input has not been selected. (If it has, the CD2/Tape2 monitor indicator on the receiver's front panel will be lit). See "What's on the Front Panel of Your Kenwood Audio - Video Receiver?" on page 2 of this manual.
- The correct speakers have been activated. See "Turning the Speakers On" on page 10 of this manual.
- The correct listen mode has been selected. See "What Are Listen Modes?" on page 16 of this manual.

I can't hear sound from my surround or center speakers

Check that:

- The proper surround play mode (Dolby 3 Stereo, Dolby Pro Logic, DSP, MPEG or Dolby Digital) has been selected. See "What are Listen Modes?" on page 16 of this manual.
- All of the speaker wires are connected tightly. See Chapter One of the *Connections and Setup Guide*.



I can hear sound only from the center speaker when Dolby Pro Logic or Dolby 3 Stereo is selected

Check that the program (e.g., TV show, radio station, VCR tape) is in stereo. Programs in mono play only through the center speaker when the receiver is in the Dolby Pro Logic listen mode.

Sound from one (or more) of my devices is abnormally loud or soft

Adjust the analog input level for that device:

1. Select the icon for the device. For CD1, Video2, Video3, and Video4, also select the Input Analog icon.

2. Touch  on the main menu then touch  :

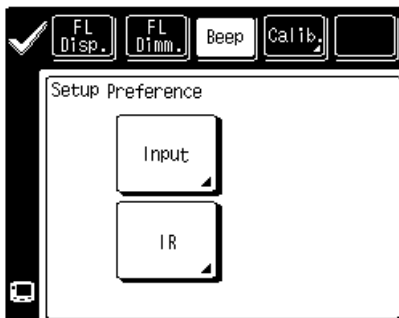

3. Select  .

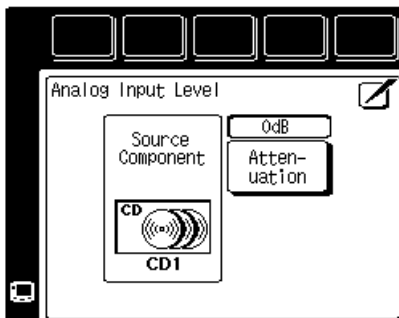

4. Touch  . Every time you select the button the volume will cycle between 0dB, -3dB, -6dB and back up to 0dB. Select the level that best matches that of the other sources.

5. Touch  to return to the Setup Preference menu; touch  to return to the previous menu.

There wasn't any sound recorded on tapes made on my VCR or tape deck

Check that:

- The audio cables are connected properly for the device.
- Analog has been set as the input type. Digital input cannot be used as source for recording to analog media (such as VHS or audio tape). See "Switching to Analog Input" on page 21.

The initial sound is intermittent or non-existent when I start to play from a Dolby Digital DVD source

- Some DVD players simply have intermittent start-up sound.
- Check that the correct digital cable is being used. The cable must be a *digital* coaxial or optical cable. See Chapter One of the *Connections and Setup Guide*.

With a Dolby Digital program, the loud sounds aren't very loud and the quiet sounds aren't very quiet

Check that volume extremes are not automatically being balanced. See "Midnight Theatre Function" on page 15 of this manual.

I hear a hum when I select the PHONO input

Check that:

- The audio cables are connected securely to the Phono jack set. See Chapter One of the *Connections and Setup Guide*.
- The turntable is grounded on the receiver. See Chapter One of the *Connections and Setup Guide*.

Video

I can't see the program I'm playing on the TV There wasn't any video output to my VCR when I recorded

- Check that the video source and TV are connected via the same type of connectors. S-Video input signals cannot be transmitted via composite (standard) connections and vice versa.
- Check that the correct video input on the TV is selected.
- Check that the video software you record does not have copy guard protection.

PowerTouch

I don't see icons for all my devices

You must identify devices for PowerTouch control for them to appear in the icon bar on PowerTouch. See Chapter Two of the *Connections and Setup Guide*.

When I select a device icon, I don't see any commands

- When you start PowerTouch for the very first time, all the possible icons appear. If you select any of them, there will be no commands in the command area. You must set up PowerTouch before you can begin controlling devices. See Chapter Two of the *Connections and Setup Guide*.

- Re-enter the setup code for the device. See Chapter Two of the *Connections and Setup Guide*.

My PowerTouch is slow to respond—sometimes I have to press buttons or select commands several times

- If PowerTouch is in sleep mode (the screen is blank), the first button press “wakes it up”. The second press performs the action.
- Your PowerTouch supports 2-way communication with the receiver. If the green light on the front of the receiver is lit, PowerTouch is receiving information. It cannot transmit your new command until it is finished receiving information from the receiver.

My PowerTouch is not responding

- Make sure you are within the operating range for PowerTouch. See page 5 of this manual.
- Replace the batteries. See Chapter Two of the *Connections and Setup Guide*.

My PowerTouch is beeping. What does that mean?

The following table includes information about PowerTouch beeps:

Number	Tone	Meaning
1	high	Confirms your most recent button push or touch
1	low	Indicates that your most recent button push or touch could not be performed
2	high	Confirms learning or copying
2	low	Indicates that learning or copying was not successful

PowerTouch does not "learn" new commands or functions.

- Check that the distance between PowerTouch and the device's remote is properly set. Do not place the device's remote right against PowerTouch.
- Check whether the PowerTouch is too close to the receiver, a TV, high-frequency fluorescent lighting or other electrical appliance.
- "Learning" may be carried out with some devices' remote.

I want to clear all the items in PowerTouch and make it to the factory-set default condition.

- While pressing and holding the CONFIRM and VOLUME DOWN button, use the stylus to press the blue button at the bottom of the battery case.

Receiver/Tuner

My receiver won't turn on and the STANDBY indicator is flashing

Your receiver is in the "protection" mode.

Check that:

- The speaker system's impedance is not too low. See Chapter One of the *Connections and Setup Guide*.
- The speaker wires are not short-circuited. Test the wires as follows to find the shorted wire and replace it:
 - Turn off the receiver, disconnect the positive and negative speaker wires of the RIGHT FRONT speaker from the receiver, and turn the receiver back on.
 - If the STANDBY indicator stops flashing, replace this wire.
 - If the STANDBY indicator does not stop flashing, turn off the receiver, reconnect the speaker wires, and repeat the first step for the next speaker.
 - Continue until you have isolated and replaced the shorted wire.
 - See Chapter One of the *Connections and Setup Guide*.

If none of the above solutions work, reset the microprocessor:

1. Turn the receiver off. (The Power button is OFF position.)
2. Press ON/STANDBY button while pressing and holding the Power button.
3. Continue to hold the Power button for more than 1 second.

The following settings are cleared:

- The device set as input (Tuner is selected by default)—see "How Do I Operate Devices?" on page 26 of this manual.

Receiver/Tuner



- The volume setting (-66dB is selected by default)—see “Adjusting the Volume” on page 10 of this manual
- The tuner’s receiving band (FM is selected by default)—see “Tuner” on page 50 of this manual
- The tuner’s frequency (87.5MHz is selected by default)—see “Tuner” on page 50 of this manual
- The tuner’s preset memory—you will need to reset your stored radio stations (see Chapter Two of the *Connections and Setup Guide*)
- The surround setting—see “What are Listen Modes?” on page 16 of this manual.
- The speaker settings—you will need to reset your speaker settings (see Chapter Two of the *Connections and Setup Guide*)

4. Reset the cleared settings before operating the receiver again.

The sound is distorted, and the CLIP indicator on the receiver’s front panel flashes red continually, or stays red for more than 1 second at a time

Lower the analog input level for the source device you’re listening to. (Setting the proper input level eliminates distortion that occurs if a source device’s output level is too high. When this happens, the front panel CLIP indicator will flash red continually or remain red for periods of 1 second or longer. Occasional brief flashing of the CLIP indicator is okay).

1. Select the icon for the source device. For CD1, Video2, Video3, and Video 4, also select the Input Analog icon.

2. Touch  on the main menu then touch  :

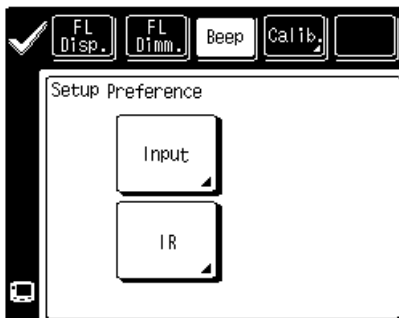

3. Select  .

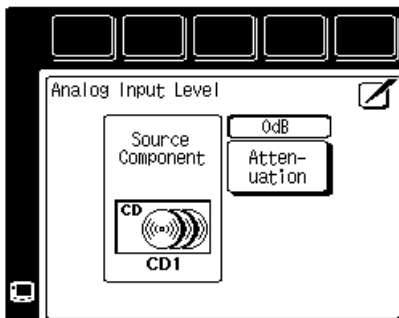

4. Touch  . Every time you select the button the volume will cycle between 0dB, -3dB, -6dB and back up to 0dB.
5. While the source component is playing, reduce the Input Level to -3dB. If the CLIP indicator still flashes frequently or remains lit for 1 second or longer, reduce the Input Level to -6dB.

6. Touch  to return to the Setup Preferences menu; touch  to return to the previous menu.

I can't access any RDS (Radio Data System) functions

- Confirm that the radio station is broadcasting RDS.
- Make sure you use the Auto Memory function to store RDS stations in memory. See "Storing RDS Stations Automatically" on page 40 of the *Connections and Setup Guide*.

I can't receive a radio station

Check that:

- The appropriate antenna is connected. See Chapter One of the *Connections and Setup Guide*.
- The broadcast band is correct. See "Tuner" on page 50 of this manual.
- The tuner is set to the correct frequency. See "Tuner" on page 50 of this manual.

I'm getting a lot of static/interference

- Check whether the receiver or antenna is too close to a TV or other electrical appliance.
- Adjust the antenna for best reception.
- If you live in an area with weak FM signals, consider a rooftop or an amplified FM antenna (available at any home electronics store).

When I press a key to tune to a preset station, the receiver does not respond

Check whether:

- The receiver has been unplugged for more than three days. If it has, your settings were cleared from the receiver's memory. See "My receiver won't turn on and the STANDBY indicator is flashing" on page 79 of this manual.
- The Tuner input is selected. See "Tuner" on page 50 of this manual.

Macro is not running as I programmed.

- Because PowerTouch can only transmit one command at a time, stagger the timings of the various macro settings so that the commands are given at different times.
- On or Off command for audio devices may not work correctly if they are not Kenwood components connected via system control cables.
- On or Off command for TV monitor may not work correctly. If it is already on, On command turns it off, and if it is already off, Off command turns it on.

When the listen mode is in "6ch Input", there are commands which the receiver does not accept.

- When in "6ch Input" mode, the commands such as selecting a different listen mode, Speaker A/B switching, CD2/TAPE2 MONITOR switching, sound adjustment and speaker level adjustment.

Numerics

- 200-Disc CD Changer
 - introductory information 36
 - operating 37
 - playing CDs 37
 - reading and storing disc titles .. 38
 - warning during PowerTouch load time 39, 40

A

- adjusting PowerTouch display screen 60
- analog input, switching 21
- AV AUX front panel 2

B

- balancing volume extremes 16
- batteries, maximizing life 60

C

- camcorder, operating 35
- CD player
 - operating 37, 43, 49
- CD2/Tape 2 Monitor indicator light 2
- changing front panel display 62
- confirm button 3
- custom macros
 - operating 68

D

- devices
 - checklist 27, 36
 - operating 26
 - troubleshooting 70
- Digital Signal Processor (DSP)
 - effects 22
- digital to analog recording 59

- digital to digital recording 58
- dimming receiver front panel 62
- Display Mode button 2
- display panel 2
- display screen
 - adjusting 60
 - devices displayed 4
- Dolby Digital
 - speakers for surround sound . 17
 - troubleshooting (AC-3)
 - programs 75
- DVD player
 - operating 33
 - switching input 21
 - troubleshooting 75

H

- headphones
 - jack 2
 - using 25
- home-theater sound 16

I

- icons
 - troubleshooting PowerTouch
 - display screen 76
- identifying components 26, 76
- Input Analog mode 21
- IR indicator and transmitters 2
- items on PowerTouch 3

J

- joystick
 - moving around on PowerTouch
 - 7
 - on PowerTouch 3

L

laser disc player, operating	34
listen modes	
defined	16
Dolby 3 Stereo	17
Dolby Digital (AC-3)	17
Dolby Pro Logic	17
DSP (Digital Signal Processing)	
.....	17
MPEG	18
setting manually	20
stereo	17
THX	18

M

macros, using	68
MD recorder, operating	46
moving around	7
mute button	2, 3
muting sound	15

O

On/Standby button	3
operating	
devices	26
macros	68
range	5

P

PHONO input, troubleshooting ...	76
playing	
video CDs	45
Power On/Standby button	2
preset stations, troubleshooting	83

R

radio stations, troubleshooting	82
RDS (Radio Data System)	
definition	51
features	51
searching for radio stations using	
PowerTouch	50
troubleshooting	82
reading and storing CD titles	38
receiver	
changing display mode	62
dimming front panel	62
items on front panel	2
troubleshooting	79
recording	56

S

satellite TV, operating	29
searching	
specific radio programs	50
setting	
DSP effects	22
listen mode manually	20
signal path, troubleshooting	70
sound	
adjusting	10
troubleshooting	72
speakers	
levels, adjusting	13
loudness, adjusting	11
selector buttons on receiver	2
tone, adjusting	11
troubleshooting	72
Surround Play, checking	19
surround sound	
listen modes	16
troubleshooting speakers	73
standby indicator light	2
switching to analog input	21

T

tape deck	
operating	48
troubleshooting	75
THX	24
tuner	
operating	50
troubleshooting	79
turntable	
operating	49
troubleshooting	76
TV	
operating	28
troubleshooting	76

U

using	
joystick to move around	7
macros	68
PowerTouch in the dark	60
PowerTouch's interface	6

V

VCR	
helpful hints when recording	
.....	58
operating	31, 35
recording a program	56
troubleshooting	76
video CDs, playing	45
volume	
adjusting	10
control knob	2

Free Manuals Download Website

<http://myh66.com>

<http://usermanuals.us>

<http://www.somanuals.com>

<http://www.4manuals.cc>

<http://www.manual-lib.com>

<http://www.404manual.com>

<http://www.luxmanual.com>

<http://aubethermostatmanual.com>

Golf course search by state

<http://golfingnear.com>

Email search by domain

<http://emailbydomain.com>

Auto manuals search

<http://auto.somanuals.com>

TV manuals search

<http://tv.somanuals.com>