

KENWOOD

INSTRUCTION MANUAL



VHF FM TRANSCEIVER

TK-7180

UHF FM TRANSCEIVER

TK-8180

KENWOOD CORPORATION

© B62-1766-10 (K)
09 08 07 06 05 04 03 02 01

THANK YOU

We are grateful you chose **KENWOOD** for your personal mobile applications. We believe this easy-to-use transceiver will provide dependable communications to keep personnel operating at peak efficiency.

KENWOOD transceivers incorporate the latest in advanced technology. As a result, we feel strongly that you will be pleased with the quality and features of this product.

MODELS COVERED BY THIS MANUAL

The models listed below are covered by this manual:

- **TK-7180:** VHF FM Transceiver
- **TK-8180:** UHF FM Transceiver

PRECAUTIONS

Please observe the following precautions to prevent fire, personal injury, and transceiver damage.

- Do not attempt to configure the transceiver while driving; it is too dangerous.
- Do not modify the transceiver for any reason.
- Do not expose the transceiver to long periods of direct sunlight, nor place it near heating appliances.
- Do not place the transceiver in excessively dusty, humid, or wet areas, nor on unstable surfaces.
- If an abnormal odor or smoke is detected coming from the transceiver, turn OFF the power immediately. Contact your **KENWOOD** dealer.

NOTICES TO THE USER

- ◆ Government law prohibits the operation of unlicensed transmitters within the territories under government control.
- ◆ Illegal operation is punishable by fine and/or imprisonment.
- ◆ Refer service to qualified technicians only.

SAFETY: It is important that the operator is aware of, and understands, hazards common to the operation of any transceiver.



◆ **EXPLOSIVE ATMOSPHERES (GASES, DUST, FUMES, etc.)**

Turn OFF your transceiver while taking on fuel or while parked in gasoline service stations. Do not carry spare fuel containers in the trunk of your vehicle if your transceiver is mounted in the trunk area.

◆ **INJURY FROM RADIO FREQUENCY TRANSMISSIONS**

Do not operate your transceiver when somebody is either touching the antenna or standing within 2 to 3 feet of it, to avoid the possibility of radio frequency burns or related physical injury.

◆ **DYNAMITE BLASTING CAPS**

Operating the transceiver within 500 feet (150 m) of dynamite blasting caps may cause them to explode. Turn OFF your transceiver when in an area where blasting is in progress, or where "TURN OFF TWO-WAY RADIO" signs have been posted. If you are transporting blasting caps in your vehicle, make sure they are carried in a closed metal box with a padded interior. Do not transmit while the caps are being placed into or removed from the container.

One or more of the following statements may be applicable:

FCC WARNING

This equipment generates or uses radio frequency energy. Changes or modifications to this equipment may cause harmful interference unless the modifications are expressly approved in the instruction manual. The user could lose the authority to operate this equipment if an unauthorized change or modification is made.

INFORMATION TO THE DIGITAL DEVICE USER REQUIRED BY THE FCC

This equipment has been tested and found to comply with the limits for a Class B digital device, pursuant to Part 15 of the FCC Rules. These limits are designed to provide reasonable protection against harmful interference in a residential installation.

This equipment generates, uses and can generate radio frequency energy and, if not installed and used in accordance with the instructions, may cause harmful interference to radio communications. However, there is no guarantee that the interference will not occur in a particular installation. If this equipment does cause harmful interference to radio or television reception, which can be determined by turning the equipment off and on, the user is encouraged to try to correct the interference by one or more of the following measures:

- Reorient or relocate the receiving antenna.
- Increase the separation between the equipment and receiver.
- Connect the equipment to an outlet on a circuit different from that to which the receiver is connected.
- Consult the dealer for technical assistance.

CONTENTS

UNPACKING AND CHECKING EQUIPMENT	1
SUPPLIED ACCESSORIES	1
PREPARATION	2
TOOLS REQUIRED	2
POWER CABLE CONNECTION	2
INSTALLING THE TRANSCEIVER	3
GETTING ACQUAINTED	4
FRONT PANEL	4
DISPLAY	5
REAR PANEL	6
PROGRAMMABLE FUNCTIONS	7
OPERATING BASICS	8
OVERVIEW	8
SWITCHING POWER ON/ OFF	8
ADJUSTING THE VOLUME	8
SELECTING A ZONE AND CHANNEL/ GROUP ID	9
TRUNKING ZONES	10
PLACING A DISPATCH CALL	10
RECEIVING A DISPATCH CALL	10
PLACING A TELEPHONE CALL	10
RECEIVING A TELEPHONE CALL	10
CONVENTIONAL ZONES	11
TRANSMITTING	11
RECEIVING	11
QUIET TALK (QT)/ DIGITAL QUIET TALK (DQT)	11
2-TONE SIGNALING	12
OPERATOR SELECTABLE TONE (OST)	12
SCAN	13
DELETE FROM SCAN/ ADD TO SCAN	13
SCAN REVERT	14
PRIORITY SCAN	14
GROUP SCAN	14

FleetSync: ALPHANUMERIC 2-WAY PAGING FUNCTION	15
SELCALL (SELECTIVE CALLING)	15
STATUS MESSAGE	16
SHORT MESSAGE	17
LONG MESSAGE	17
GPS REPORT	17
DTMF (DUAL TONE MULTI FREQUENCY) CALLS	18
MANUAL DIALING	18
STORE AND SEND	19
AUTODIAL	19
REDIAL	20
CONNECT/ DISCONNECT IDs	20
DTMF SIGNALING	21
STUN	21
EMERGENCY CALLS	22
ADVANCED OPERATIONS	23
TALK-AROUND	23
MONITOR/ SQUELCH OFF	23
SCRAMBLER	24
CLOCK	24
LCD BRIGHTNESS	25
HORN ALERT	25
PUBLIC ADDRESS (PA)	25
BACKGROUND OPERATIONS	26
TIME-OUT TIMER (TOT)	26
BUSY CHANNEL LOCKOUT (BCL)	26
SIGNAL STRENGTH INDICATOR	26
BEGINNING/ END OF TRANSMIT SIGNAL	26
VGS-1 OPTIONAL VOICE GUIDE & STORAGE UNIT	27
VOICE RECORDER	27
VOICE GUIDE	28

UNPACKING AND CHECKING EQUIPMENT

Note: The following unpacking instructions are for use by your **KENWOOD** dealer, an authorized **KENWOOD** service facility, or the factory.

Carefully unpack the transceiver. We recommend that you identify the items listed in the following table before discarding the packing material. If any items are missing or have been damaged during shipment, file a claim with the carrier immediately.

SUPPLIED ACCESSORIES

Item	Part Number	Quantity
Microphone (with cable)	T91-0639-XX	1
Microphone hanger (with self-tapping screws)	J19-1584-XX	1 set
DC power cable	E30-7523-XX	1
• Fuse (15 A)	F51-0024-XX	2
Mounting bracket	J29-0662-XX	1
Screw set: <ul style="list-style-type: none">• Self-tapping screw (4 pieces)• Hex-headed screw with washer (4 pieces)• Spring washer (4 pieces)• Flat washer (4 pieces)	N99-2039-XX	1
Instruction manual	B62-1766-XX	1

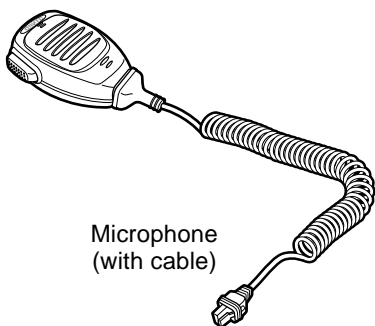

Microphone
(with cable)

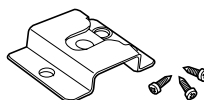

Microphone hanger
(with self-tapping screws)

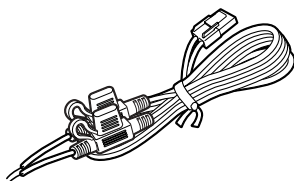

DC power cable
(with fuses)

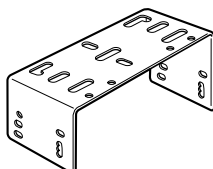

Mounting bracket

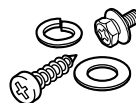

Screw set

PREPARATION



WARNING

Various electronic equipment in your vehicle may malfunction if they are not properly protected from the radio frequency energy which is present while transmitting. Electronic fuel injection, anti-skid braking, and cruise control systems are typical examples of equipment that may malfunction. If your vehicle contains such equipment, consult the dealer for the make of vehicle and enlist his/her aid in determining if they will perform normally while transmitting.

Note: The following preparation instructions are for use by your **KENWOOD** dealer, an authorized **KENWOOD** service facility, or the factory.

TOOLS REQUIRED

Note: Before installing the transceiver, always check how far the mounting screws will extend below the mounting surface. When drilling mounting holes, be careful not to damage vehicle wiring or parts.

The following tools are required for installing the transceiver:

- 1/4 inch (6 mm) or larger electric drill
- 5/32 inch (4.2 mm) drill bit for the self-tapping screws
- Circle cutters

POWER CABLE CONNECTION



CAUTION

The transceiver operates in **12 V** negative ground systems only! Check the battery polarity and voltage of the vehicle before installing the transceiver.

- 1 Check for an existing hole, conveniently located in the firewall, where the power cable can be passed through. If no hole exists, use a circle cutter to drill the firewall, then install a rubber grommet.
- 2 Run the 2 power cable leads through the firewall and into the engine compartment, from the passenger compartment.
- 3 Connect the red lead to the positive (+) battery terminal and the black lead to the negative (-) battery terminal.
 - Locate the fuse as close to the battery as possible.
- 4 Coil and secure the surplus cable with a retaining band.
 - Be sure to leave enough slack in the cables so the transceiver can be removed for servicing while keeping the power applied.

INSTALLING THE TRANSCEIVER



WARNING

For passenger safety, install the transceiver securely using the supplied mounting bracket so the transceiver will not break loose in the event of a collision.

- 1 Mark the position of the holes in the dash by using the mounting bracket as a template. Drill the holes, then attach the mounting bracket using the supplied self-tapping screws.
 - Be sure to mount the transceiver in a location where the controls are within easy reach of the user and where there is sufficient space at the rear of the transceiver for cable connections.
- 2 Connect the antenna and the supplied power cable to the transceiver.
- 3 Slide the transceiver into the mounting bracket and secure it using the supplied hex-headed screws.
- 4 Mount the microphone hanger, using the supplied self-tapping screws, in a location where it will be within easy reach of the user.
 - The microphone and microphone cable should be mounted in a place where they will not interfere with the safe operation of the vehicle.



CAUTION

When replacing the fuse in the DC power cable, be sure to replace it with a fuse of the same value. Never replace a fuse with a fuse that has a higher value.

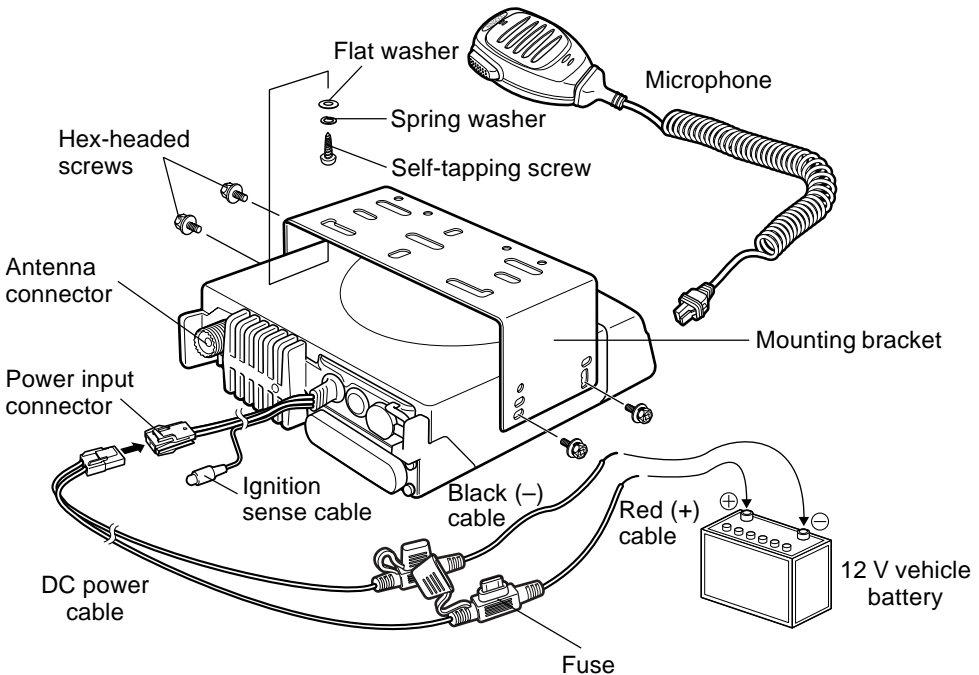

GETTING ACQUAINTED

FRONT PANEL

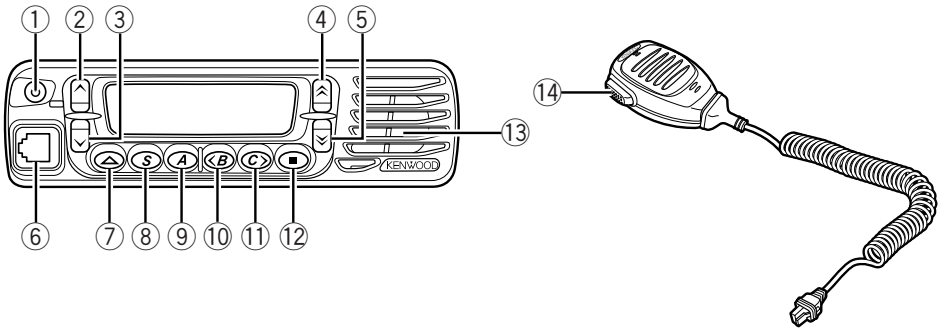

- ① **⏻ (Power) switch**
Press to switch the transceiver ON. Press again to switch the transceiver OFF.
- ② **^ key**
Press to activate its programmable function {page 7}. The default setting is Volume Up.
- ③ **∨ key**
Press to activate its programmable function {page 7}. The default setting is Volume Down.
- ④ **⤴ key**
Press to activate its programmable function {page 7}. The default setting is Zone Up.
- ⑤ **⤵ key**
Press to activate its programmable function {page 7}. The default setting is Zone Down.
- ⑥ **Microphone jack**
Insert the microphone plug into this jack.
- ⑦ **⤴ key**
Press to activate its programmable function {page 7}. The default setting is None (no function).
- ⑧ **S key**
Press to activate its programmable function {page 7}. The default setting is Squelch Off Momentary.
- ⑨ **A key**
Press to activate its programmable function {page 7}. The default setting is None (no function).

⑩ <B key

Press to activate its programmable function {page 7}. The default setting is CH/GID Down.

⑪ C> key

Press to activate its programmable function {page 7}. The default setting is CH/GID Up.

⑫ ■ key

Press to activate its programmable function {page 7}. The default setting is None (no function).

⑬ Speaker

Internal speaker.







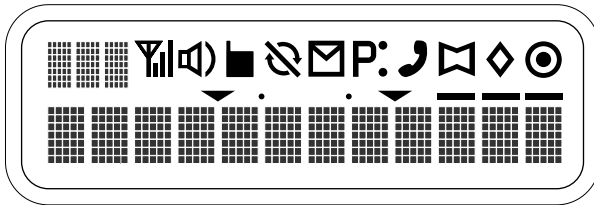



⑭ PTT (Push-to-Talk) switch

Press and hold this switch, then speak into the microphone to call a station.

DISPLAY

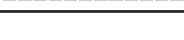

Indicator	Description
	Displays the zone, group ID, and channel numbers. Your dealer can program zone, group ID, and channel names with up to 12 characters, in place of numbers. Also displays received FleetSync messages.
	Displays the zone, group ID, and channel numbers. Also displays list numbers for Operator Selectable Tones.
	Displays the strength of received signals. An antenna and all 3 strength bars represents strong signals while the antenna by itself (no strength bars) represents weak signals.
	Appears when a key programmed as Monitor or Squelch is pressed.
	Appears when the Talk Around function has been activated.
	Appears when you are using Scan mode.
	Flashes when you receive a message. Lights when a message is stored in the stack memory.
P:	Appears when the selected channel is programmed as priority. P: represents Priority Channel 1, P: represents Priority Channel 2, and P: represents Priority Channels 1 and 2.

Indicator	Description
	Appears when the selected group is programmed as telephone IDs.
	Appears when the Horn Alert function is activated.
	Appears when the Scrambler function is activated.
	Appears when the Public Address function is activated.
	Appears when the selected zone is added to the scanning sequence.
	Appears when the Auto Recording function on the VGS-1 option is activated.
	Appears when an Auto Reply Message on the VGS-1 option is activated.
	Appears when the selected group or channel is added to the scanning sequence.
	Appears when the AUX A function has been activated.
	Appears when the AUX B function has been activated.
	Appears when the OST function has been activated.

REAR PANEL

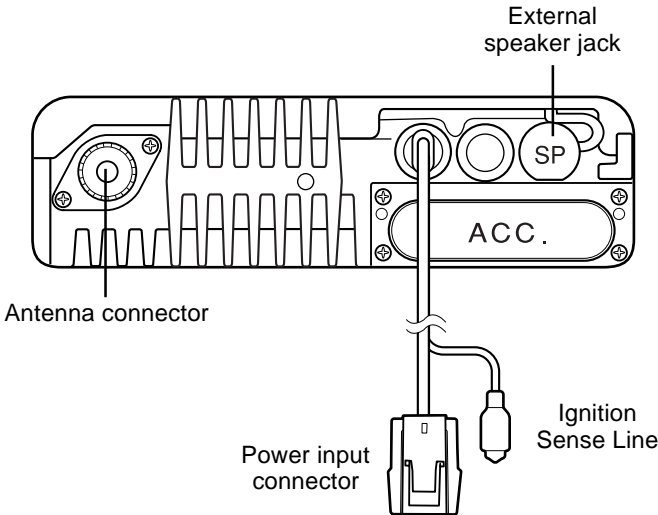

PROGRAMMABLE FUNCTIONS

The ^, v, ^, v, ^, S, A, <B, C>, and ■ keys can be programmed with the functions listed below. Please contact your dealer for further details on these functions.

- 2-tone ¹
- Autodial
- Autodial Programming
- Auto Reply Message ²
- Auto Telephone
- AUX A
- AUX B
- Call 1 ~ Call 6
- CH/GID Down (<B key default)
- CH/GID Recall
- CH/GID Up (C> key default)
- Channel Entry
- Clock
- Direct CH/GID 1 ~ Direct CH/GID 5
- Display Character
- Emergency ³
- Fixed Volume
- Function
- Home CH/GID
- Horn Alert
- LCD Brightness
- Monitor
- Monitor Momentary
- None
- OST ¹
- Playback ²
- Public Address
- Scan
- Scan Delete/Add
- Scrambler
- Selcall
- Selcall + Status
- Send the GPS data
- Squelch Level ¹
- Squelch Off
- Squelch Off Momentary (S key default)
- Status
- Talk Around
- Telephone Disconnect
- Transceiver Password
- Volume Down (v key default)
- Volume Up (^ key default)
- Zone Down (v key default)
- Zone Up (^ key default)

¹ "2-tone", "OST", and "Squelch Level" can be used only in Conventional zones.

² "Auto Reply Message" and "Playback" can be programmed only when the optional VGS-1 board has been installed.

³ "Emergency" can be programmed only on the ^ key.

OPERATING BASICS

OVERVIEW

Your dealer can program your transceiver with Trunking and Conventional zones. The transceiver can handle up to 128 zones with up to 250 channels/ group IDs in each zone and a total combined maximum of 512 channels/ group IDs. Zones, channels/ group IDs, and their functions are programmed by your dealer.

SWITCHING POWER ON/ OFF

Press the **⏻** switch to switch the transceiver ON.

- A beep sounds and the display momentarily lights up.
- If the Transceiver Password function is programmed, "PASSWORD" appears on the display. You must enter the password to unlock the transceiver. Refer to "Transceiver Password", below.

Press the **⏻** switch again to switch the transceiver OFF.

■ TRANSCEIVER PASSWORD

To enter the password:

- 1 Press the **^** and **∨** keys to select a digit.
- 2 Press the **C>** key to accept the entered digit and move to the next digit.
 - Press the **A** key to delete an incorrect character. Press and hold the **A** key to delete all entered characters.
 - Repeat steps 1 and 2 to enter the entire password.
- 3 Press the **S** key to confirm the password.
 - If you enter an incorrect password, an error tone sounds and the transceiver remains locked.

To enter the password using an optional DTMF keypad:

- 1 Press the DTMF keys corresponding to the password digits.
 - Press the **A** or DTMF **#** key to delete an incorrect character. Press and hold the **A** or DTMF **#** key to delete all entered characters.
- 2 Press the **S** or DTMF ***** key to confirm the password.
 - If you enter an incorrect password, an error tone sounds and the transceiver remains locked.

ADJUSTING THE VOLUME

Press the key programmed as **Volume Up** to increase the volume and **Volume Down** to decrease the volume.

- The default setting for the **^** key is **Volume Up**.
- The default setting for the **∨** key is **Volume Down**.

SELECTING A ZONE AND CHANNEL/ GROUP ID

Select the desired zone using the keys programmed as **Zone Up** and **Zone Down**.

- The default setting for the $\hat{\wedge}$ key is **Zone Up**.
- The default setting for the $\hat{\vee}$ key is **Zone Down**.

Select the desired channel or group ID using the keys programmed as **CH/GID Up** and **CH/GID Down**.

- The default setting for the **<B** key is **CH/GID Down**.
- The default setting for the **C>** key is **CH/GID Up**.

Names can be programmed for zones and channels/ group IDs with up to 12 characters each. However, to fit on the display, names will be abbreviated. Your dealer can set the zone name to a length of 0 to 12 digits. Channel/ group ID names will shorten appropriately, to fit in the 12-digit display.

For example, if your dealer sets the zone name to 3 digits, the zone name is “KENWOOD” and the channel/ group ID name is “-CHANNEL1-”, the following message appears on the display.

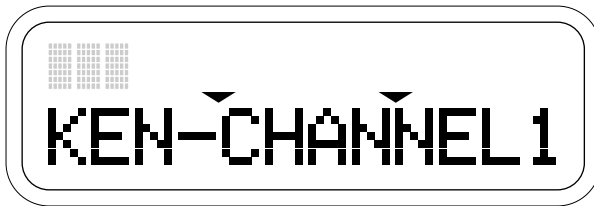

TRUNKING ZONES

PLACING A DISPATCH CALL

- 1 Select the desired zone and group ID using the **Zone** and **CH/GID** keys.
- 2 Press and hold the **PTT** switch.
- 3 If the PTT Proceed tone sounds, communication is possible; start speaking into the microphone. Release the **PTT** switch to receive.
 - For best sound quality at the receiving station, hold the microphone approximately 1.5 inches (3 ~ 4 cm) from your mouth.
 - Your dealer can deactivate the PTT Proceed tone, if necessary. Ask your dealer for details.

RECEIVING A DISPATCH CALL

- 1 When a dispatch call is received, the transceiver will automatically change to the correct group ID and you will hear the call.
- 2 Readjust the volume as necessary, using the **Volume** keys.

PLACING A TELEPHONE CALL

- 1 Select the desired zone and group ID using the **Zone** and **CH/GID** keys.
 - Alternatively, you can press the key programmed as **Auto Telephone** to automatically search for a Telephone Repeater.
- 2 Press and hold the **PTT** switch for approximately 1 second to ensure a connection.
 - Confirm that there is a dial tone after you release the **PTT** switch.
- 3 Place the call, following the instructions for making a DTMF call, starting on page 18.
- 4 When the called party responds, press the **PTT** switch and speak into the microphone. Release the **PTT** switch to receive.
 - Only one person can speak at a time.
- 5 To end the call, press and hold the **PTT** switch, then press the DTMF # key or the key programmed as **Telephone Disconnect**.

RECEIVING A TELEPHONE CALL

- 1 When a telephone call is received, the transceiver will automatically change to the correct group ID and you will hear the call.
 - A ringer tone will sound when a call is received.
- 2 Press and hold the **PTT** switch to speak, and release it to receive.
 - Only one person can speak at a time.
- 3 To end the call, press and hold the **PTT** switch, then press the DTMF # key or the key programmed as **Telephone Disconnect**.

CONVENTIONAL ZONES

TRANSMITTING

- 1 Select the desired zone and channel using the **Zone** and **CH/GID** keys.
- 2 Press the key programmed as **Monitor** or **Squelch Off** to check whether or not the channel is free.
 - If the channel is busy, wait until it becomes free.
- 3 Press the **PTT** switch and speak into the microphone. Release the **PTT** switch to receive.
 - For best sound quality at the receiving station, hold the microphone approximately 1.5 inches (3 ~ 4 cm) from your mouth.

RECEIVING

- 1 Select the desired zone and channel using the **Zone** and **CH/GID** keys.
 - Alternatively, you can turn the Scan function on if desired.
- 2 When you hear a caller's voice, readjust the volume as necessary, using the **Volume** keys.

QUIET TALK (QT)/ DIGITAL QUIET TALK (DQT)

Your dealer may have programmed QT or DQT signaling on your transceiver channels. A QT tone/ DQT code is a sub-audible tone/ code which allows you to ignore (not hear) calls from other parties who are using the same channel.

When a channel is set up with a QT tone or DQT code, squelch will only open when a call containing a matching tone or code is received. Likewise, signals that you transmit will only be heard by parties whose QT/ DQT signaling matches your transceiver.

If a call containing a different tone or code is made on the same channel you are using, squelch will not open and you will not hear the call. This allows you to ignore (not hear) these calls. Although it may seem like you have your own private channel while using QT/ DQT, other parties can still hear your calls if they set up their transceiver with the same tone or code.

2-TONE SIGNALING

2-tone Signaling is enabled or disabled by your dealer. This function opens the squelch only when the transceiver receives the 2 tones programmed in your transceiver. Transceivers that do not transmit the correct tones will not be heard.

■ RECEIVING

When you receive a signal containing the correct tones, squelch opens and you will hear the call.

- The LED indicator flashes orange.
- To mute the speaker after squelch opens, press the key programmed as **Monitor**.
- Your dealer can program the squelch to close again after a specific time period elapses.
- If Transpond for 2-tone Signaling is programmed, an acknowledgment signal is returned to the calling station.
- If Call Alert for 2-tone Signaling is programmed, an alert tone will sound when the correct tones are received.

■ TRANSMITTING

- 1 Select your desired zone and channel.
- 2 Press the key programmed as **2-tone**.
- 3 Press the **<B and C>** keys to select the 2-tone code of the station you want to call.
 - If programmed by your dealer, you can also use the $\hat{\wedge}$ and $\hat{\vee}$ keys.
- 4 Press the **PTT** switch and begin your conversation.

Note: If Single Tone has been activated, only the first tone of the 2-tone signal will be transmitted.

OPERATOR SELECTABLE TONE (OST)

You can change the preset encode and decode tones for the selected channel. Your dealer can program up to 40 tones on your transceiver.

To switch OST On or Off, press the key programmed as **OST**.

- The OST indicator (■■■■■■■■■■) appears on the display when this function is activated.

To change the preset encode/ decode tones:



- 1 Press and hold the key programmed as **OST** for approximately 1 second.
 - The OST number and name appear on the display.
- 2 Press the **<B and C>** keys to select your desired encode/ decode pair.
 - If programmed by your dealer, you can also use the $\hat{\wedge}$ and $\hat{\vee}$ keys.
- 3 Press the **S** key to accept the new setting and return to normal operation.

SCAN

If the Scan function is programmed, zones or channels can be scanned by pressing the key programmed as **Scan**. Scan can be used as either Single Scan, Multi Scan, or List Scan.

- Single Scan monitors only the channels of the currently selected zone, which have been added to the scanning sequence. If set up to scan Priority channels, the Priority channels will be scanned even if they are not within the currently selected zone.
- Multi Scan monitors all channels of every zone, which have been added to the scanning sequence.
- List Scan monitors all channels within the specified range of zones, which have been added to the scanning sequence. If set up to scan Priority channels, the Priority channels will be scanned even if they are not within any of the zones in the list.



To activate Scan, press the key programmed as **Scan**.

- The  icon and "SCAN" or the revert zone and channel/ group ID number appear on the display.
- The zone add indicator () will appear on the display when the selected zone is added to the scan sequence. The channel/ group ID add indicator () will appear on the display when the selected channel/ group ID is added to the scan sequence.
- When a call is received, scanning stops and the zone and channel/ group ID digits appear. Press the **PTT** switch and speak into the microphone to respond to the call. The transceiver will continue scanning after a predetermined time delay if the **PTT** switch is released and no further signal is received.

To stop scanning, press the **Scan** key again.

DELETE FROM SCAN/ ADD TO SCAN

Press and hold the key programmed as **Scan Delete/Add**, to add or remove each zone or channel/ group ID to or from the scan sequence.

- The zone add indicator () will appear on the display when the selected zone is added to the scan sequence.
- The channel/ group ID add indicator () will appear on the display when the selected channel/ group ID is added to the scan sequence.

SCAN REVERT

You can select Revert zones and channels/ group IDs using the **Zone** and **CH/GID** keys.

Eight types of Scan Reverts which can be programmed by your dealer are available.

- **Last Called Revert:** The last zone/ group ID received is assigned as the new revert zone and group ID.
- **Last Used Revert:** The last zone/ group ID responded to is assigned as the new revert zone and group ID.
- **Selected:** The last zone/ group ID selected is assigned as the new revert zone and group ID.
- **Selected + Talkback:** If the zone/ group ID has been changed during Scan, the newly selected zone/ group ID is assigned as the new revert zone and group ID. The transceiver “talks back” on the current receive group ID.
- **Priority 1/ Priority 2:** If your dealer has programmed a Priority channel (either Priority 1 or Priority 2), this channel is the revert zone and channel.
- **Priority 1 + Talkback/ Priority2 + Talkback:** If your dealer has programmed a Priority channel (either Priority 1 or Priority 2), this channel is the revert zone and channel. The transceiver “talks back” on the current receive channel.

Note: “Priority” and “Priority + Talkback” are not available for Trunking Systems.

PRIORITY SCAN

A Priority channel must be programmed in order for Priority Scan to function.

The transceiver will automatically change to the Priority channel when a signal is received on it, even if a signal is being received on a normal channel.

- The P^{*} indicator represents the Priority 1 channel.
- The P. indicator represents the Priority 2 channel.
- The P: indicator represents both the Priority 1 and Priority 2 channel.

Note: Priority cannot be programmed onto the group ID of a Trunking zone; it can be used only on channels of Conventional zones.

GROUP SCAN

Group Scan is useful when more than one channel/ group ID is programmed in a zone. Group Scan is set by your dealer on request. It scans the revert groups as well as groups that are allowed to be scanned.

When a call is received, the group indicator shows the channel/ group ID, and that group becomes the revert group. Simply press the **PTT** switch to respond to the call.

FleetSync: ALPHANUMERIC 2-WAY PAGING FUNCTION

FleetSync is an Alphanumeric 2-way Paging Function, and is a protocol owned by **KENWOOD** Corporation. FleetSync enables a variety of paging functions on your transceiver, some of which depend on dealer programming.

Your dealer can set up either FleetSync or FleetSync II on your transceiver. Transceivers set up with FleetSync can communicate with other transceivers that have been set up with FleetSync. Likewise, transceivers set up with FleetSync II can communicate with other transceivers set up with FleetSync II. However, transceivers set up with FleetSync cannot communicate with transceivers that have been set up with FleetSync II and vice-versa.

SELCALL (SELECTIVE CALLING)

A Selcall is a voice call to a particular station or to a group of stations.

■ TRANSMITTING

- 1 Select your desired zone and group (or zone and channel).
- 2 Press the key programmed as **Selcall** or **Selcall + Status** to enter Selcall Mode.
- 3 Press the **<B** and **C>** keys to select the ID of the station you want to call.
 - If programmed by your dealer, you can also use the **^** and **∨** keys.
 - If Manual Dialing is enabled, you can enter digits by using an optional DTMF keypad or by selecting digits with the **^** and **∨** keys. When using the **^** and **∨** keys, cycle through the digits to select a digit, then press the **C>** key to accept the digit and shift the cursor to the right. Repeat this process until the entire ID is entered.
- 4 Press the **PTT** switch and begin your conversation.
 - Alternatively, you can press the **■** key to page the selected station, rather than making a voice call.

■ RECEIVING

An alert tone will sound, the transceiver will automatically enter Selcall Mode, and the calling station's ID will appear when a Selcall is received.

To respond to the call, press the **PTT** switch and speak into the microphone.

■ IDENTIFICATION CODES

An ID code is a combination of a 3-digit Fleet number and a 4-digit ID number. Each transceiver must have its own Fleet and ID number.

- Enter a Fleet number (100 ~ 349) to make a group call.
- Enter an ID number (1000 ~ 4999) to make an individual call in your fleet.
- Enter a Fleet number make a call to all units in the selected fleet (Interfleet call).
- Enter an ID number to make a call to the selected ID in all fleets (Supervisor call).
- Select "ALL" Fleet and "ALL" ID to make a call to all units (Broadcast call).

Note: The ID range may be limited by programming.













STATUS MESSAGE

You can send and receive 2-digit Status messages which may be decided in your talk group. Messages can contain up to 16 alphanumeric characters. Status messages range from 10 to 99 (80 ~ 99 are reserved for special messages).

A maximum of 15 received messages can be stored in the stack memory of your transceiver. These saved messages can be reviewed after reception.

Depending on your dealer settings, when the stack memory is full, either the oldest message will be erased when a new message is received or the new message will not be stored in the stack memory. The  icon lights when a message is stored in the stack memory.

■ TRANSMITTING

- 1 Select your desired zone and group (or zone and channel).
- 2 Press the key programmed as **Status** to enter Status Mode or **Selcall + Status** to enter Selcall Mode.
 - When using the **Status** key to enter Status Mode, the target Fleet/ ID is fixed and cannot be selected. Skip to step 5 to continue.
- 3 In Selcall Mode, press the **<B and C>** keys to select the ID of the station you want to call.
 - If programmed by your dealer, you can also use the  and  keys.
 - If Manual Dialing is enabled, you can enter digits by using an optional DTMF keypad or by selecting digits with the  and  keys. When using the  and  keys, cycle through the digits to select a digit, then press the **C>** key to accept the digit and shift the cursor to the right. Repeat this process until the entire ID is entered.
- 4 Press the **S** key to enter Status Mode.
- 5 Press the **<B and C>** keys to select the status ID you want to transmit.
 - If programmed by your dealer, you can also use the  and  keys.
 - If Manual Dialing is enabled, you can enter digits by using an optional DTMF keypad or by selecting digits with the  and  keys. To enter manual input mode, first press and hold the **S** key. When using the  and  keys, cycle through the digits to select a digit, then press the **C>** key to accept the digit and shift the cursor to the right. Repeat this process until the entire ID is entered.
- 6 Press the **PTT** switch or  key to initiate the Status call.
 - "«COMPLETE»" is displayed when the call has been successfully transmitted.

■ RECEIVING

The  icon will flash and a calling ID or text message will appear when a Status call is received.

Press any key to return to Normal Operation Mode.

■ REVIEWING MESSAGES IN THE STACK MEMORY

- 1 Press and hold the key programmed as **Selcall**, **Status**, or **Selcall + Status** for 1 second to enter Stack Mode.
 - The last received message is displayed with the message number.
- 2 Press the **<B** and **C>** keys to select the desired message.
 - If programmed by your dealer, you can also use the **^** and **∨** keys.
 - Press and hold the **S** key to toggle between the message/ call ID, the channel name, and the time of the received message.
- 3 Press the **S** key to return to Normal Operation Mode.
 - To delete the selected message, press the **A** or DTMF # key. To confirm the deletion, press the **S** or DTMF * key.
 - To delete all messages, press and hold the **A** or DTMF # key for 1 second. To confirm the deletion, press the **S** or DTMF * key.

SHORT MESSAGES

To send a short message, you must connect the transceiver to a PC. Ask your dealer for details.

- Short messages can contain a maximum of 48 characters.
- Received short messages are displayed the same as Status messages and are stored in the same stack memory. A combined maximum of 15 Status calls and short messages can be stored in the stack memory.

LONG MESSAGES

To send and receive long messages, you must connect the transceiver to a PC. Ask your dealer for details.

- Long messages can contain a maximum of 4096 characters.

GPS REPORT

To send your location data, you must first install a GPS unit (NMEA-0183 format) onto the transceiver. Press the key programmed as **Send the GPS data** to transmit your location data. Ask your dealer for details.

DTMF (DUAL TONE MULTI FREQUENCY) CALLS

MANUAL DIALING

Note: To make a DTMF call using manual dialing, you must use an optional microphone with a DTMF keypad.

■ METHOD 1

Press and hold the **PTT** switch, then enter the desired digits using the optional keypad.

- If you release the **PTT** switch, transmit mode will end even if the complete number has not been sent.
- If your dealer has activated the Keypad Auto PTT function, you need not press the **PTT** switch while pressing the keys on the keypad in Conventional systems. The DTMF code will be sent automatically when you press a key.

Note: Keypad Auto PTT does not function in Trunking systems.

■ METHOD 2

Enter the desired digits using the optional keypad (maximum of 30 digits). After entering the complete number, press the **PTT** switch.

- In Conventional systems, the DTMF code is transmitted after pressing the **PTT** switch.
- In Trunking systems, the DTMF code is transmitted after a connection is established. Releasing the **PTT** switch before a connection is established will stop the transmission from occurring.
- In RIC (Repeater Inter-Connect) Trunking systems, the DTMF code is transmitted after a connection with the telephone system is established. Press the key programmed as **Autodial** (instead of the **PTT** switch) to automatically connect to the repeater and transmit the DTMF code.

Note: If you turn the power OFF before sending the number, the number will be cleared from memory.

STORE AND SEND

Store and send allows you to make DTMF calls without the need for a DTMF keypad.

- 1 Press the key programmed as **Autodial**.
 - "CODE?" appears on the display.
- 2 Press the \wedge and \vee keys to select a digit.
 - Alternatively, you can enter the digits by using an optional DTMF keypad.
- 3 Press the **C>** key to accept the entered digit and move to the next digit.
 - Press the **A** or DTMF # key to delete an incorrect character. Press and hold the **A** or DTMF # key to delete all entered characters.
 - You can enter up to 30 digits.
- 4 Press the **PTT** switch to make the call after the number is entered.

AUTODIAL

Autodial allows you to store 32 names (up to 12 characters per name) and DTMF numbers (up to 16 digits per number).

■ STORING DTMF NUMBERS

- 1 Press the key programmed as **Autodial Programming**.
 - The first entry in the Autodial list appears on the display.
- 2 Press the **<B** and **C>** keys or the appropriate DTMF key to select your desired Autodial list number (01 ~ 32).
 - If programmed by your dealer, you can also use the \wedge and \vee keys.
 - "NAME?" appears on the display after selecting a number.
- 3 Enter the desired name using the \wedge and \vee keys or the optional DTMF keypad. Select a character, then press the **C>** key to confirm the character and move the cursor to the right. Repeat this operation until the complete name is entered, then press the **S** key to confirm the entry.
 - Press the **A** or DTMF # key to delete an incorrect character. Press and hold the **A** or DTMF # key to delete all entered characters.
 - "CODE?" appears on the display after confirming the entered name.
- 4 Enter the desired number using the \wedge and \vee keys or the optional DTMF keypad. When using the keypad, simply enter the desired number, followed by the **S** key to confirm the entry. When using the \wedge and \vee keys, cycle through the digits to select a digit, then press the **C>** key to confirm the digit and move the cursor to the right. Repeat this operation until the complete number is entered, then press the **S** key to confirm the entry.
 - Press the **A** or DTMF # key to delete an incorrect character. Press and hold the **A** or DTMF # key to delete all entered characters.
 - "STORE?" appears on the display after confirming the entered number.
- 5 Press the **S** or DTMF * key to store the entered name and number in the Autodial list.
 - Press the **A** or DTMF # key to cancel the entry.
 - If you are overwriting a previous entry, "Overwrt?" appears on the display. Press the **S** or DTMF * key to overwrite the entry, or press the **A** or DTMF # key to cancel.

■ DIALING STORED DTMF NUMBERS

- 1 Press the key programmed as **Autodial**.
 - The first entry in the Autodial list appears on the display.
- 2 Press the \wedge and \vee or **<B and C>** keys or press the appropriate DTMF key to select your desired Autodial list number (01 ~ 32).
 - The stored entry appears on the display.
- 3 Press the **PTT** switch to make the call.

■ CLEARING STORED DTMF NUMBERS

- 1 Press the key programmed as **Autodial Programming**.
- 2 Press the \wedge and \vee or **<B and C>** keys, or press the appropriate DTMF key to select your desired Autodial list number (01 ~ 32).
- 3 Press the **A** or DTMF # key.
 - "DELETE?" appears on the display after confirming the entered number.
- 4 Press the **S** or DTMF * key to delete the entry from the Autodial list.
 - The selected memory location is cleared.

REDIAL

You can redial the last number you transmitted.

Note: To redial a number, you must use an optional microphone with a DTMF keypad.

- 1 Press the key programmed as **Autodial**.
 - The first entry in the Autodial list appears on the display.
- 2 Press the DTMF * key followed by the DTMF **0** key to display the last called number.
- 3 Press the **PTT** switch to make the call.

Note: Turning OFF the transceiver power clears the redial memory.

CONNECT/ DISCONNECT IDs

Note: To transmit connect/ disconnect IDs, you must use an optional microphone with a DTMF keypad.

- 1 Press the key programmed as **Autodial**.
 - The first entry in the Autodial list appears on the display.
- 2 Connect ID: Press the DTMF * key two times.
Disconnect ID: Press the DTMF * key followed by the DTMF # key.
- 3 Press the **PTT** switch to make the call.

DTMF SIGNALING

DTMF Signaling is either enabled or disabled by your dealer. This function opens the squelch only when the transceiver receives the DTMF code programmed in your transceiver. Each transceiver is normally programmed with a unique code. You will not hear calls from transceivers that are not programmed with a matching code.

When you receive a signal containing the correct tones, squelch opens and you will hear the call.

- The LED indicator flashes orange.
- To mute the speaker after squelch opens, press the key programmed as **Monitor**.
- Your dealer can program the squelch to close again after a specific time period elapses.
- If Transpond for DTMF Signaling is programmed, an acknowledgment signal is returned to the calling station.
- If Tone Alert for DTMF Signaling is programmed, an alert tone will sound when the correct tones are received.

STUN

This function is used when a transceiver is lost or stolen. When the transceiver receives a call containing a stun code, either transmit mode will be disabled or both receive mode and transmit mode will be disabled. Stun is cancelled when the transceiver receives a call with a revive code.

EMERGENCY CALLS

If your transceiver has been programmed with the Emergency function, you can make emergency calls.

- 1 Press and hold the key programmed as **Emergency**.
 - Depending on the delay time programmed into your transceiver, the length of time you must hold the **Emergency** key will vary.
 - When the transceiver enters Emergency mode, the transceiver will change to the Emergency channel and begin transmitting based on how the transceiver is set up by your dealer. Transmit periods are also set by your dealer.
- 2 To exit Emergency mode, press and hold the **Emergency** key again.
 - If the Emergency mode completes the preset number of cycles, Emergency mode will automatically end and the transceiver will return to the channel that was in use before Emergency mode was entered.

Note:

- ◆ Your dealer can set the transceiver to emit a tone when Emergency mode starts and stops
 - ◆ Your dealer can set the transceiver to emit tones and received signals as normal or mute the speaker during Emergency operation.
-

ADVANCED OPERATIONS

TALK AROUND

You may occasionally experience an interruption in service (due to a power failure, etc.). During such an occurrence, you can continue communication by using the Talk Around feature. Talk Around allows you to communicate directly with other transceivers, without the use of a repeater. However, if the station you want to contact is too far away, or there are geographical obstacles in the way, you may not be able to contact the station.

To toggle Talk Around between On and Off, press the key programmed as **Talk Around**.

- The ■ icon appears on the display while Talk Around is active.
- When using Talk Around, the receive frequency is used for both transmitting and receiving, and the decode signaling is used for both encoding and decoding.

MONITOR/ SQUELCH OFF

You can use the key programmed as **Monitor/ Squelch Off** to listen to weak signals that you cannot hear during normal operation and to adjust the volume when no signals are present on your selected channel.

- The ◀ icon appears on the display while Monitor/ Squelch Off is activated.

Note: **Squelch Off** can be used only in Conventional operating mode.

Your dealer can program a key with one of 4 functions:

- **Monitor:** Momentarily press to deactivate QT, DQT, DTMF, 2-tone, or FleetSync Signaling. Press the key again to return to normal operation.
- **Monitor Momentary:** Press and hold to deactivate QT, DQT, DTMF, 2-tone, or FleetSync Signaling. Release the key to return to normal operation.
- **Squelch Off:** Momentarily press to hear background noise. Press the key again to return to normal operation.
- **Squelch Off Momentary:** Press and hold to hear background noise. Release the key to return to normal operation.

■ SQUELCH LEVEL

To adjust the squelch level in Conventional operating mode:

- 1 Press the key programmed as **Squelch Level**.
- 2 Press the ≡ or <B key to decrease the squelch level (open) and the ^ or C> key to increase the squelch level (tighten).
- 3 Press the S key to store the new setting and exit the squelch level adjustment.

SCRAMBLER

Although the scrambler function does not offer complete privacy with your calls, it does prevent others from easily listening in on your calls. When activated, the transceiver distorts your voice so that anybody listening to your conversation will not be able to clearly hear what you are saying.

In order for members of your own group to clearly hear your call while you are using the scrambler, all other members must also activate the scrambler functions on their transceivers. This distorts everybody's voice while transmitting and corrects the voice message on your own transceiver when you receive the call.

To activate the scrambler, press the key programmed as **Scrambler**.

- The  icon appears on the display while the scrambler is active.

To deactivate the scrambler, press the **Scrambler** key again.

Note: There are 2 options for using the scrambler. Your dealer can activate or deactivate the built-in scrambler function of the transceiver, or they can add a more secure optional scrambler board to your transceiver. Ask your dealer for details.



CLOCK

If activated by your dealer, your transceiver can track the time and date with its built-in clock. The time will display momentarily when the transceiver power is turned ON. Additionally, you can view the clock any time by pressing the key programmed as **Clock**.

Note: Removing the transceiver power for extended periods will cause the clock time to clear.

■ CLOCK SETUP

To set the year, month, day, and time:

- 1 With the transceiver power OFF, press and hold the **C>** key while turning the transceiver power ON.
 - The current year setting appears.
- 2 Press the  and  keys to select the year, then press the **S** key to cycle to the month setting.
 - Repeat this step, to cycle through the day, hour, and minute settings.
- 3 Press the **S** key again, to return to the year setting.
 - A triple beep will sound, indicating that your selections have been set into the transceiver memory.
- 4 Turn the transceiver power OFF and then back ON to return to Normal Operation Mode.

LCD BRIGHTNESS

The LCD backlight can be turned off or set to low or high levels. To cycle through the brightness settings, press the key programmed as **LCD Brightness**.

- Each press of LCD Brightness cycles the brightness level from high to low to off and then back to high.

HORN ALERT

To use the Horn Alert function, your dealer must install an optional KAP-2 unit. When a call is received that has a correct DTMF code or 2-tone signaling, Horn Alert causes the vehicle horn or some other external alert to sound. This function notifies you of a received call when you are out of your vehicle.

To toggle Horn Alert between On and Off, press the key programmed as **Horn Alert**.

- The  icon appears on the display while Horn Alert is active.

PUBLIC ADDRESS (PA)

To use the Public Address system, your dealer must install an optional KAP-2 unit and an external speaker. This function causes all audio input via the microphone to be amplified and output from the external speaker.

To use the PA system:

- 1 Press the key programmed as **Public Address**.
 - The  icon appears on the display while the PA system is active.
- 2 Press the **PTT** switch, then speak into the microphone.
 - Use the **Volume Up** and **Volume Down** keys to adjust the audio output from the external speaker.
- 3 Press the **Public Address** key again to return to normal operation.

BACKGROUND OPERATIONS

TIME-OUT TIMER (TOT)

The purpose of the Time-out Timer is to prevent any caller from using a channel for an extended period of time.

If you continuously transmit for a period of time that exceeds the programmed time set by your dealer (default is 1 minute for Conventional and dispatch (Trunking) operation, and 3 minutes for telephone (Trunking) operation), the transceiver will stop transmitting and an alert tone will sound. To stop the tone, release the **PTT** switch.

Your dealer can program the TOT time in the range of 15 seconds to 20 minutes for Conventional operation and 15 seconds to 10 minutes for Trunking operation.

BUSY CHANNEL LOCKOUT (BCL)





When activated, BCL prevents you from interfering with other parties who may be using the same channel that you selected, in Conventional operating mode. Pressing the **PTT** switch while the channel is in use will cause your transceiver to emit an alert tone and transmission will be inhibited (you cannot transmit). Release the **PTT** switch to stop the tone and return to receive mode.

If activated, you can override this function. To override BCL, press the **PTT** switch again immediately after releasing it (within half a second).

Note: Ask your dealer for an explanation on how BCL functions when using QT, DQT, DTMF, 2-tone, or FleetSync signaling.

SIGNAL STRENGTH INDICATOR

The signal strength indicator displays the strength of received calls:

-  Strong signal
-  Medium signal
-  Weak signal
-  Very weak signal

BEGINNING/ END OF TRANSMIT SIGNAL

The Beginning of Transmit and End of Transmit identification signals are used to access and release some repeaters and telephone systems.

If Beginning of Transmit is set, the ID signal is transmitted when you press the **PTT** switch.

If End of Transmit is set, the ID signal is transmitted when you release the **PTT** switch.

If both are set, the ID signal is transmitted when you press and release the **PTT** switch.

VGS-1 OPTIONAL VOICE GUIDE & STORAGE UNIT

When using the optional VGS-1 voice guide & storage unit, you gain access to the voice recorder and voice announcement functions. Ask your dealer for details.

VOICE RECORDER

The voice recorder function allows you to record your conversations and create voice memos and automated message responses.

■ AUTO RECORDING

If activated, the auto recording function will continuously record all transmitted and received signals. The recording storage area retains 30 seconds of recording, so all transmitted and received signals are simultaneously recorded and erased, leaving only the last 30 seconds of recording in memory.

- The auto recording indicator (■■■■■■■■■■) appears when this function is activated.

■ VOICE MEMOS

To record a voice memo, for later playback:

- 1 Press and hold the key programmed as **Playback** for 1 second.
 - The duration of recording memory will appear on the display and begin counting down.
- 2 Speak into the microphone to record your voice memo.
- 3 Press the ■ key to end the recording at any time and store it into the transceiver memory.
 - If the memory becomes full, recording will stop automatically and store the voice memo to memory.
 - "WRITING" appears on the display while the recording is being stored to memory.

■ AUTO REPLY MESSAGE

You can set the transceiver to automatically respond to Individual Calls (while using FleetSync):

- 1 Press the key programmed as **Auto Reply Message** to enter Auto Reply Message mode.
 - The Auto Reply Message indicator (■■■■■■■■■■) appears on the display.
- 2 When you receive an Individual Call, Auto Reply will begin after waiting for 3 seconds, the transceiver will send an automatic response to the caller, and "GREETING" appears on the display.
 - If you are available to receive the call, press any key to disable the auto response.
 - If there is a channel available on your transceiver for recording, "I am not available. Leave your Message." will be sent to the caller. The caller can then leave a recorded message on your transceiver which you can later recall and listen to. When a message is stored on your transceiver, "MSG Rcvd" appears on the display.
 - If there is no channel available on your transceiver for recording, "I am not available." will be sent to the caller and "MEMORY FULL" appears on the display.

■ PLAYBACK

To play back a recorded conversation, memo, or message:

- 1 Press the key programmed as **Playback** to enter Playback mode.
 - If the last action on your transceiver was to auto record your conversation, "STORE?" will appear on the display, otherwise a recording channel with the time of the recording will appear. To store the conversation record in the next available recording channel, press the ■ key. To clear the conversation, press the **A** or DTMF # key. To skip to the stored recording channels, press the **S** or DTMF * key. To skip back 5 seconds, press the <**B** key. To skip ahead 5 seconds, press the **C**> key.
- 2 Press the ^ and v keys to select the channel which you want to play back.
 - "RM" represents automated reply messages.
 - "RR" represents conversation records.
 - "UM" represents voice memos.
- 3 The transceiver will announce the channel, then the recording will automatically play back.
 - When the entire recording has been played, "END OF MSG" is displayed.
 - To delete the selected recording, press the **A** or DTMF # key. To clear all the recorded data, press and hold the **A** or DTMF # key. A confirmation message will appear on the display. Press the **S** or DTMF * key to delete the recording(s) or the **A** or DTMF # key to cancel.

VOICE GUIDE

When changing the zone, group ID, channel, or operation mode, an audio voice will announce the new zone, group ID, channel, or mode, after it has been selected. (Voice Annunciation can be activated or deactivated by your dealer.)

Free Manuals Download Website

<http://myh66.com>

<http://usermanuals.us>

<http://www.somanuals.com>

<http://www.4manuals.cc>

<http://www.manual-lib.com>

<http://www.404manual.com>

<http://www.luxmanual.com>

<http://aubethermostatmanual.com>

Golf course search by state

<http://golfingnear.com>

Email search by domain

<http://emailbydomain.com>

Auto manuals search

<http://auto.somanuals.com>

TV manuals search

<http://tv.somanuals.com>