



# IMPORTANT SAFEGUARDS

ILLUSTRATION

! **Caution:** Read this section carefully to ensure safe operation.

Please read all of the safety and operating instructions before operating this unit. For best results, follow all warnings placed on the unit and adhere to the operating and use instructions. These safety and operating instructions should be retained for future reference.

- 1. Power sources** — The unit should be connected to a power supply only of the type described in the operating instructions or as marked on the appliance.
- 2. Power-cord protection** — Power supply cords should be routed so that they are not likely to be walked on or pinched by items placed upon or against them, pay particular attention to cords at plugs, convenience receptacles, and the point where they exit from the unit.
- 3. Enclosure removal** — Never remove the enclosure. If the internal parts are touched accidentally, a serious electric shock might occur.
- 4. Drop** — Do not drop the unit or apply strong shock to it. (Damage due to dropping the unit is not covered by the warranty.)
- 5. Ventilation** — Avoid hindering the ventilation of the unit by covering it with a cloth, etc.
- 6. Abnormal smell** — If an abnormal smell or smoke is detected, immediately turn the power OFF and pull out the power cord. Contact your dealer or nearest service center.
- 7. Heat** — Avoid placing the unit under direct sunlight or near a source of heat such as heating equipment. Particularly, never leave it in an automobile or on the dashboard.
- 8. Temperature** — The unit may not function properly if used at extremely low, or freezing temperatures. The ideal ambient temperature is above +5°C (41°F).
- 9. Water and moisture** — The unit should not be used near water — for example, near a bathtub, washbowl, kitchen sink, laundry tub, in a wet basement, or near a swimming pool, etc.
- 10. Dust and moisture** — Avoid places where is dusty or where the humidity is high.
- 11. Vibrations** — Avoid placing the unit on an unstable place such as a shelf or in a place subject to vibrations.
- 12. Magnetic fields** — Keep the unit away from sources of magnetic fields such as TV sets, speaker systems, radios, motorized toys or magnetized objects.
- 13. Cleaning** — Do not use volatile solvents such as alcohol, paint thinner, gasoline, or benzine, etc. to clean the cabinet. Use a clean dry cloth.
- 14. Nonuse periods** — The power cord of the unit should be unplugged from the outlet when left unused for a long period of time.
- 15. Damage requiring service** — The unit should be serviced by qualified service personnel when:
  - A. The power-supply cord or the plug has been damaged.
  - B. Objects have fallen, or liquid has been spilled into the unit.
  - C. The unit has been exposed to rain.
  - D. The unit does not appear to operate normally or exhibits a marked change in performance.
  - E. The unit has been dropped, or the enclosure damaged.
- 16. Servicing** — The user should not attempt to service the unit beyond that described in the operating instructions. All other servicing should be referred to qualified service personnel.
- 17. CAUTION** — TO PREVENT ELECTRIC SHOCK DO NOT USE THE AC PLUG WITH AN EXTENSION CORD, RECEPTACLE OR OTHER OUTLET UNLESS THE BLADES CAN BE FULLY INSERTED TO PREVENT BLADE EXPOSURE.

## For rechargeable battery

### WARNING

- Use specified charger only.
- Do not disassemble or mutilate, cause burns.
- Do not incinerate or heat, may cause burns, burst or release toxic materials.
- Do not short circuit, may cause burns.
- Keep away from children.



## Dear Customer:

Selecting the right equipment such as the unit you've just purchased is only the start of your enjoyable enjoyment. Now, to make the most of it, you can maximize the fun and excitement your equipment offers. This manufacturer and the Electronic Industries Association's Consumer Electronics Group want you to get the most out of your equipment by playing it at a safe level. One that lets the sound come through loud and clear without annoying blaring or distortion — and, most importantly, without affecting your sensitive hearing.

Sound can be deceiving. Over time your hearing "comfort level" adapts to higher volumes of sound. So what sounds "normal" can actually be loud and harmful to your hearing. Guard against this by setting your equipment at a safe level BEFORE your hearing adapts.

### To establish a safe level:

- Start your volume control at a low setting.
- Slowly increase the sound until you can hear it comfortably and clearly, and without distortion.

### Once you have established a comfortable sound level:

- Set the dial and leave it there.

Taking a minute to do this now will help to prevent hearing damage or loss in the future. After all, we want you listening for a lifetime.

## We Want You Listening For A Lifetime

Used wisely, your new sound equipment will provide a lifetime of fun and enjoyment. Since hearing damage from loud noise is often undetectable until it is too late, this manufacturer and the Electronic Industries Association's Consumer Electronics Group recommend you avoid prolonged exposure to excessive noise. This list of sound levels is included for your protection.

Decibel Level	Example
30	Quiet library, soft whispers
40	Living room, refrigerator, bedroom away from traffic
50	Light traffic, normal conversation, quiet office
60	Air conditioner at 20 feet, sewing machine
70	Vacuum cleaner, hair dryer, noisy restaurant
80	Average city traffic, garbage disposals, alarm clock at two feet.

## THE FOLLOWING NOISES CAN BE DANGEROUS UNDER CONSTANT EXPOSURE

90	Subway, motorcycle, truck traffic, lawn mower
100	Garbage truck, chain saw, pneumatic drill
120	Rock band concert in front of speakers, thunderclap
140	Gunshot blast, jet plane
180	Rocket launching pad

Information courtesy of the Deafness Research Foundation.

## For the U.S.A.

### CAUTION:

Use of controls or adjustments or performance of procedures other than those specified herein may result in hazardous radiation exposure.

In compliance with Federal Regulations, following are reproductions of labels on, or inside the product relating to laser product safety.

KENWOOD CORPORATION  
2967-3, ISHIKAWA-CHO,  
HACHIOJI-SHI,  
TOKYO, JAPAN

KENWOOD CORP. CERTIFIES THIS  
EQUIPMENT CONFORMS TO DHHS  
REGULATIONS NO. 21 CFR 1040.10,  
CHAPTER I, SUBCHAPTER J.

Location: Bottom Panel

## Main Unit

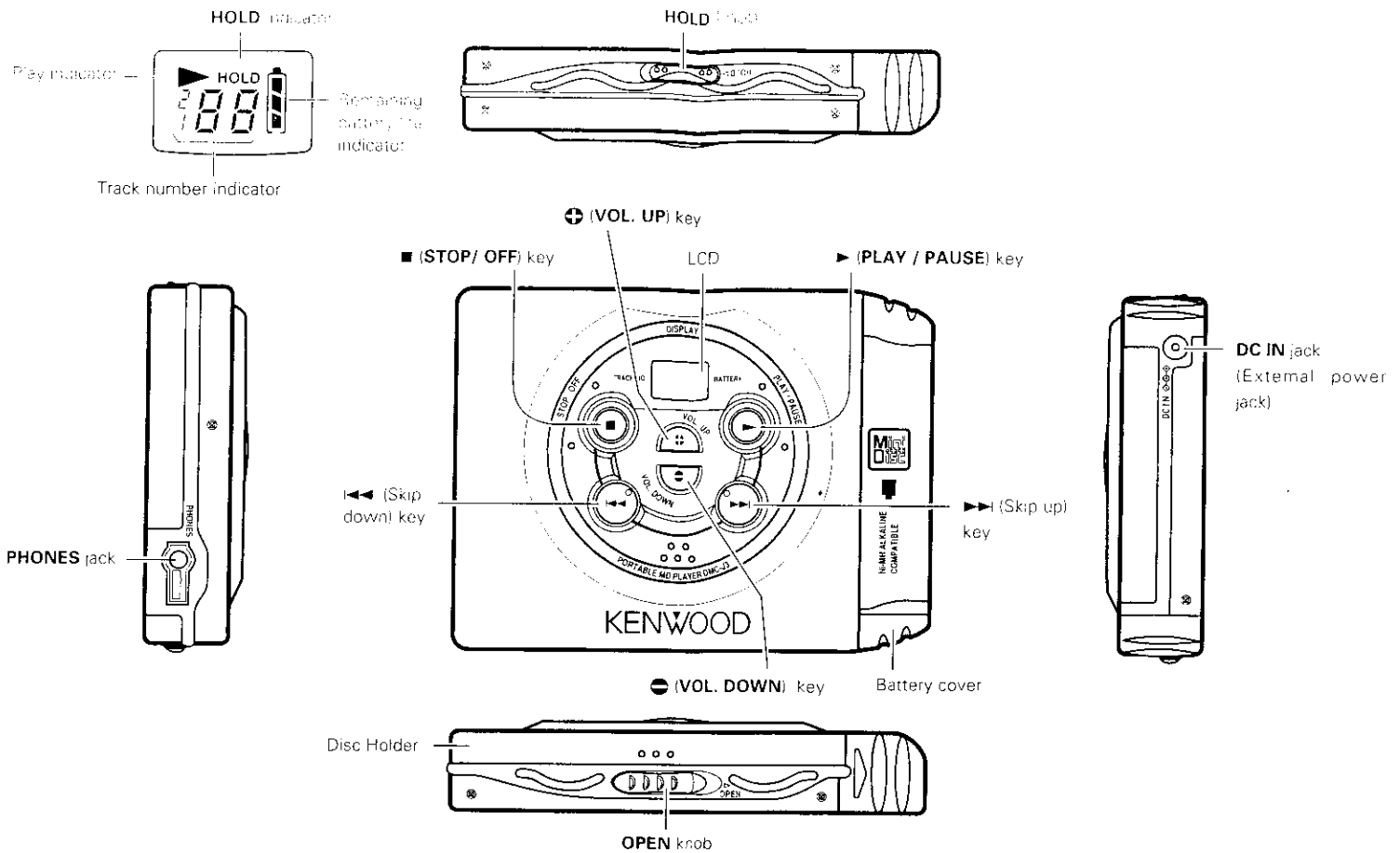

## Remote Control

Functions marked with an asterisk (\*) indicate operations performed in **SHIFT Mode**.

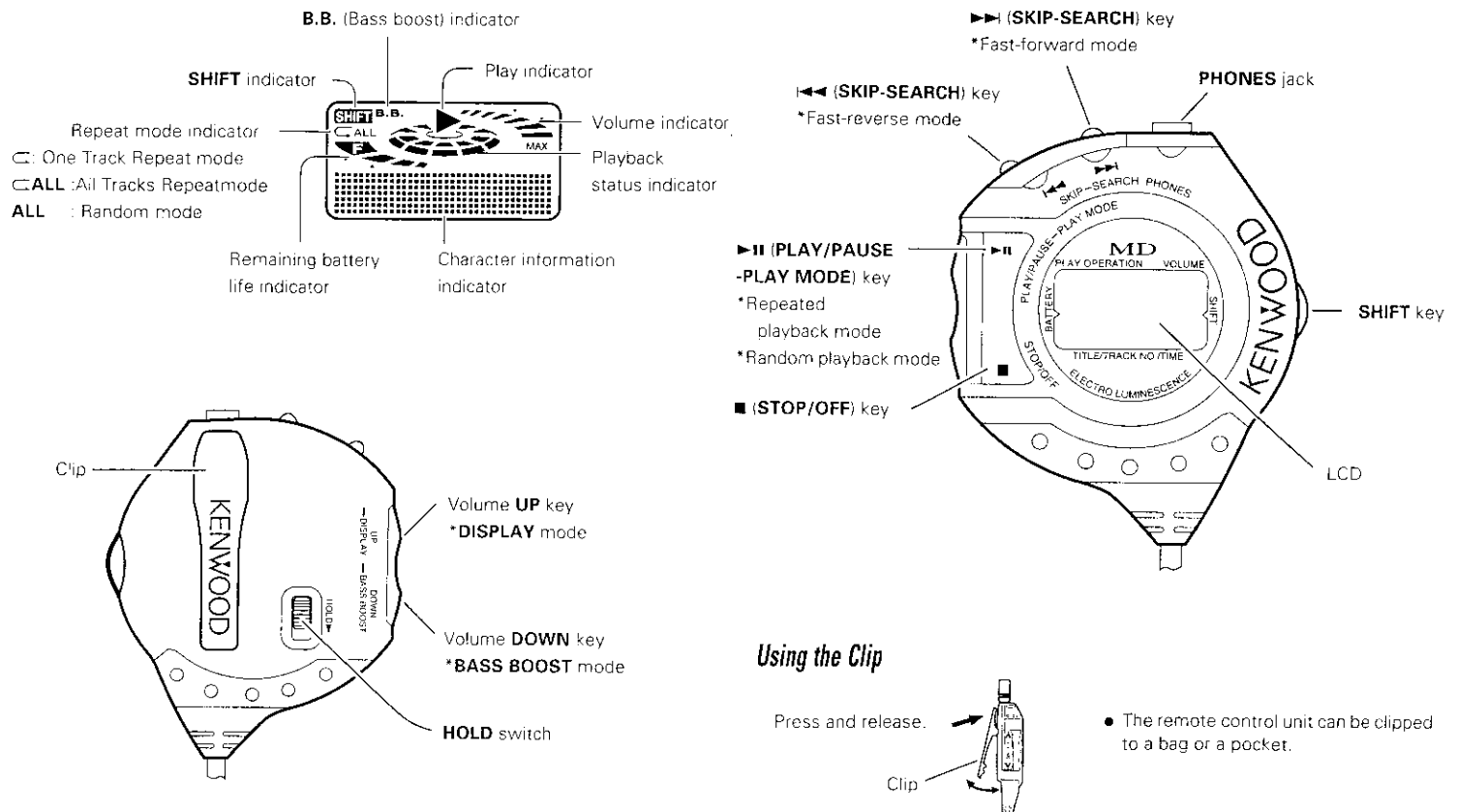

## Power sources

**Caution:** Read this section carefully to ensure safe operation.

### Power Supply

The specially provided rechargeable battery, commercially sold AA alkaline battery, the specially provided AC adaptor, the special car battery adaptor, and other power sources can be used for this unit. Use the power supply that suits the application of the unit.

#### Using the AC adaptor

To household outlet:

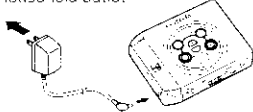

To DC IN jack

- AC adaptors may differ depending on the country or sales region.

#### When Using the Rechargeable Battery

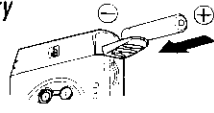

- Insert the battery making sure the positive (+) and negative (-) poles are correctly aligned.
- When using the battery for the first time, charge the battery before using it.

#### When Using Commercially Sold AA Alkaline Battery (LR6)

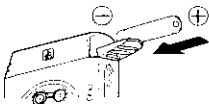

- Insert the AA alkaline battery making sure the positive (+) and negative (-) poles are correctly aligned.

#### For use in a car

Please use the separately sold car battery adaptor (DC-C70) and car cassette adaptor (CAC-2) for listening connected to a car stereo system.

## Charging the rechargeable battery

### HOLD Function

Cancel the HOLD function with the HOLD knob and then operate the keys. When the HOLD function is engaged, the unit will not respond to operation of the keys. For details, refer to "Avoiding Faulty Operation (HOLD)."

The specially provided rechargeable battery is not fully charged. When using it for the first time, charge the battery according to the following procedure.

- Charge the battery with the power to the unit turned OFF. (The battery is not charged while the unit is in operation.)

#### 1 Set the rechargeable battery in place.

- Open the rechargeable battery cover.



- Slide the battery cover up.
- Open the battery cover.

- Insert the rechargeable battery and close the cover.

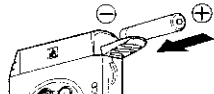

- Insert the rechargeable battery making sure the positive (+) and negative (-) poles are correctly aligned.

#### 2 Charge the battery.

- Connect the specially provided AC adaptor.

To household outlet

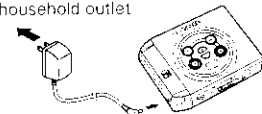

To DC IN jack

- Press the STOP/OFF key twice in succession.

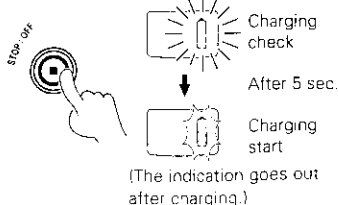

Charging check  
After 5 sec.  
Charging start  
(The indication goes out after charging.)

- When the charging indication does not light though the rechargeable battery has been set correctly, it is possible that the life of the rechargeable battery has been reached.
- The time needed to charge the battery fully is about 4 hours.
- A fully charged battery can be used for about 5 hours. (Charging time may differ slightly depending on the environment the unit is used in.)

## Playback (Basics)

### Playback

Cancel the HOLD function with the HOLD knob and then operate the keys. When the HOLD function is engaged, the unit will not respond to operation of the keys. For details, refer to "Avoiding Faulty Operation (HOLD)."

#### 1 Connect the remote control and headphone.

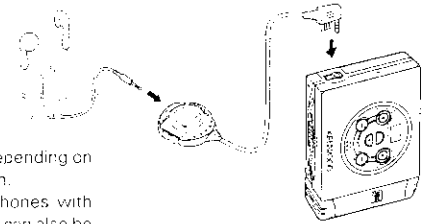

- Headphones may differ depending on the country or sales region.
- Commercially sold headphones with stereo mini plugs (3.5mm) can also be used.

#### 2 Inserting a recorded MD

- Open the disc holder.

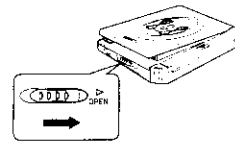

- Do not force the disc holder open, for this will damage it.

- Insert the MD and close the disc holder by hand.

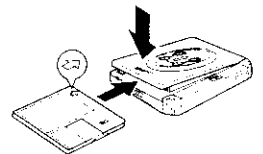

- Press the center of the MD until the disc is locked into place.

#### 3 Start playback

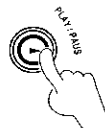

Main unit

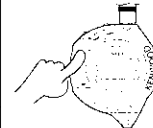

Remote control

- Power comes ON and Playback starts from the first song.
- Track titles are not displayed if the MD has no track titles on it. In this case, "NO TITLE" is first displayed and then the track number or elapsed time is displayed.
- The "▶" indicator will illuminate and the playback status display will revolve.
- After the last track is over, playback will stop.

### Skip Function

Using the ◀◀ key and ▶▶ key, you can skip to the start of the track you want to listen to.

#### Skip Up Function

▶▶ : Track number increases

- When the ▶▶ is pressed repeatedly and the last track is reached, the last track will be played back.
- Each time the ▶▶ key is pressed during playback, the operation will skip to and play back the subsequent track.
- When the ▶▶ key is pressed and held down, the track numbers will change rapidly (except during Random Playback).

#### Skip Down Function

◀◀ : Track number decreases

- When the ◀◀ is pressed repeatedly and the first track is reached, the first track will be played back.
- When the ◀◀ key is pressed while playback is in progress, operation will skip to the start of the track currently being played back, and playback will resume from there.
- When the ◀◀ key is pressed and held down, the track numbers will change rapidly (except during Random Playback).

### Adjust the volume

**Min unit** : Adjust the volume with the VOL. UP (⏮)/VOL. DOWN (⏭) keys.

**Remote control** : Adjust the volume with the volume UP/volume DOWN keys.

- Volume level indicator (0 to 30). (The volume level is displayed on the remote control.)

### To pause playback

Press during playback status.

**Min unit** : Press the PLAY / PAUSE (⏮) key.

**Remote control** : Press the PLAY / PAUSE (⏮) key.

- Each time the key is pressed, pause and playback modes are changed over.

### Stopping playback

Press during playback or pause status.

**Min unit** : Press the STOP / OFF (■) key.

**Remote control** : Press the STOP / OFF (■) key.

### Turning the power off

Press during stop status.

**Min unit** : Press the STOP / OFF (■) key.

**Remote control** : Press the STOP / OFF (■) key.

- The power will automatically turn off if the unit is not operated for about 3 minutes after it has stopped.

When Playback is started again, it will start from the start of the track that was being played back when playback was stopped. (Playback will start from the first track if the MD has been removed from the unit.) This is called the "RESUME" function.

### Removing the MD

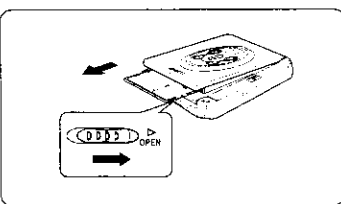

- After the power is turned off, slide the OPEN knob in the direction of the arrow and remove the MD.

### Fast forward / fast reverse (SEARCH)

Operate the key while playback is in progress. (only by remote control operation).

① Press the SHIFT key

② Press and hold down either the ⏮ key or the ⏭ key.

**For forward search:**  
keep pressing the ⏭ key during playback.

**For reverse search:**  
keep pressing the ⏮ key during playback.

- When you lift your finger off the key, normal playback will be resumed.



1. In fast forward mode, stop status is engaged when the end of the last track is reached.
2. In reverse mode, playback starts when the start of the first track is reached.
3. Depending on recording conditions, sound interruptions may occur during a fast forward/reverse operation.

### Selecting Play Mode

Press during playback or stop status. (Random mode cannot be engaged while playback is in progress.) (only by remote control operation).

① Press the SHIFT key

② Press the PLAY (▶) key

The Play Mode changes each time the ▶ key is pressed.

Repeat / Random mode display

- ① Not lit : Released
- ② : The track being played will be played repeatedly.
- ③ ALL : All tracks of the disc will be played repeatedly.
- ④ ALL : Random playback mode

Character information indication

- ① OFF : Released
- ② ONE : The track being played will be played repeatedly.
- ③ ALL : All tracks of the disc will be played repeatedly.
- ④ RANDOM : Random playback mode



1. After stop status has been engaged during repeat playback, when playback is resumed, repeat playback will start from the point where playback was stopped.
2. After the disc has been removed, playback will start normally, from the first track.

### Changing the tone (BASS BOOST)

Press during playback or stop status. (only by remote control operation).

① Press the SHIFT key

② Press the volume DOWN key

The mode changes each time the volume DOWN key is pressed.

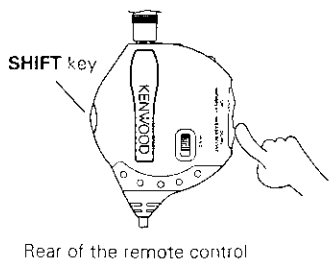

- ① BASS 0: Cancel
- ② BASS 1: Bass is boosted slightly.
- ③ BASS 2: Bass is boosted more.



When the bass is boosted, raising the volume excessively will result in sound distortion. If this happens, either lower the bass level or the volume level.

## Setting AUTO POWER SAVE

Press during playback or stop status.

Normally, the unit is set to "auto PS" mode to conserve the battery. When using the unit in a place where it is subject to vibration or impact, set "PS off" mode before operating the unit.

(only by remote control operation).

- 1 Press the SHIFT key
- 2 Keep pressing the ►|| key until the display appears.

The play mode changes each time the ►|| key is pressed.

- 1 "auto PS": power conservation mode
- 2 "PS off": skip guard mode

## Changing the display

(only by remote control operation).

### When pressed during STOP operation:

- 1 Press the SHIFT key
- 2 Press the volume UP key

The mode changes each time the volume UP key is pressed.

- 1 Disc name
- 2 Total number of tracks
- 3 Total playing time

### When pressed during PLAY operation:

- 1 Press the SHIFT key
- 2 Press the volume UP key

The mode changes each time the volume UP key is pressed.

- 1 Title of track being played
- 2 Number of track currently being played
- 3 Elapsed time of track currently being played

 Track titles or disc names are not displayed if they are not recorded on the disc.

## Convenient functions

### Avoiding faulty operation (HOLD)

When you are operating the unit on a train or when you are carrying it with the power off, this function allows you to prevent faulty operation due to accidental key operation. (Both the main unit and remote control should be carried with the HOLD function engaged.)

#### Activating HOLD status for main unit keys only

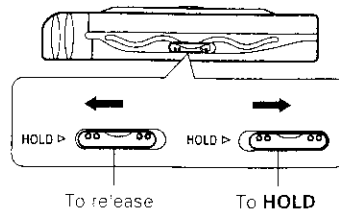

#### Activating HOLD status for remote control keys only

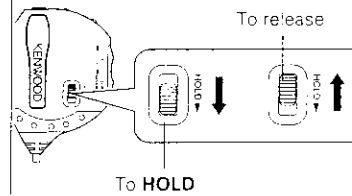

### Activating the operating tone (Beep)

The operating tone can be activated or deactivated. (only by remote control operation).

#### Deactivating the Operating Tone

- 1 Press the SHIFT key
- 2 Keep pressing the volume DOWN key until "BP off" is displayed.

- The operating tone will beep twice.
- The operating tone will not beep even when an operation key is pressed.

#### Activating the Operating Tone

- 1 Press the SHIFT key
- 2 Keep pressing the volume DOWN key until "BP on" is displayed.

- The operating tone will beep once.
- The operating tone will beep when an operation key is pressed.

 The operating tone's status - activated (BP on) or deactivated (BP off) - will be stored in memory even when the power is turned OFF.

### Operating Tone (Beep)

The operating tone will beep when the following keys are operated. The operating tone can be canceled.

Key	Type of sound
PLAY (►) key (at the time of power ON)	Short beep, short beep, short beep
PLAY (►) key (playback operation)	Short beep, short beep
STOP (■) key	Long beep
SKIP (►  ) key	Short beep, short beep, long beep
SKIP (◀◀) key	Long beep, short beep, short beep

## In case of difficulty

If you think the unit is not operating properly, check the symptoms before requesting service.

### Troubleshooting

Symptom	Cause	Remedy
Unit fails to turn ON.	<ul style="list-style-type: none"> <li>The disc holder is not securely closed.</li> <li>The battery is depleted.</li> <li><b>HOLD</b> status is engaged.</li> </ul>	<ul style="list-style-type: none"> <li>Close disc holder securely.</li> <li>Charge the battery.</li> <li>Deactivate <b>HOLD</b> status.</li> </ul>
There is no sound.	<ul style="list-style-type: none"> <li>The volume is at minimum level.</li> <li>The remote control or headphones are disconnected.</li> </ul>	<ul style="list-style-type: none"> <li>Increase the volume.</li> <li>Insert plug securely.</li> </ul>
The unit does not respond to key operation.	<ul style="list-style-type: none"> <li><b>HOLD</b> status is engaged.</li> <li>The battery is depleted.</li> <li>The remote control or headphone plug is not securely inserted.</li> <li>The disc holder is not securely closed.</li> </ul>	<ul style="list-style-type: none"> <li>Deactivate <b>HOLD</b> status.</li> <li>Charge the battery.</li> <li>Insert plug securely.</li> <li>Close disc holder securely.</li> </ul>
Sound skips.	<ul style="list-style-type: none"> <li>The disc is scratched or damaged or the recording is not good.</li> <li>The unit is in a place where there is excessive vibration.</li> </ul>	<ul style="list-style-type: none"> <li>Replace the MD.</li> <li>Move the unit to a place where there is little vibration or set to <b>'PS off'</b>.</li> </ul>
Battery does not charge.	<ul style="list-style-type: none"> <li>You are using commercial rechargeable battery.</li> <li>The unit has become hot because of exposure to direct sunlight etc.</li> <li>You are using another AC adaptor than the accessory adaptor.</li> <li>The AC adaptors has become disconnected.</li> </ul>	<ul style="list-style-type: none"> <li>Use the special rechargeable battery (<b>NB-130</b>).</li> <li>Wait until the unit has cooled to normal temperature.</li> <li>Use the accessory AC adaptor.</li> <li>Connect the AC adaptor securely.</li> </ul>

### Meaning of display messages

Message	Meaning	Action
"noDISC"	<ul style="list-style-type: none"> <li>There is no MD in the unit.</li> </ul>	<ul style="list-style-type: none"> <li>Insert a MD into the unit.</li> </ul>
"BLANK"	<ul style="list-style-type: none"> <li>Nothing is recorded on this MD.</li> </ul>	<ul style="list-style-type: none"> <li>Replace the disc with a prerecorded MD when playing it back.</li> </ul>
"ERROR"	<ul style="list-style-type: none"> <li>The <b>*UTOC</b> contents are faulty.</li> <li>The disc is scratched or damaged, so Playback is not possible.</li> </ul>	<ul style="list-style-type: none"> <li>Replace the MD.</li> <li>Replace the MD.</li> </ul>
"LoBATT"	<ul style="list-style-type: none"> <li>The inside of the unit has become hot during charging.</li> </ul>	<ul style="list-style-type: none"> <li>Wait until the inside of the unit cools down.</li> </ul>

\* **UTOC** : A recordable MD has an area for recording so-called **UTOC (User's Table of Contents)** data. The **UTOC** contains number of tracks, playing time, written data, and other rewritable information.

### Resetting the unit

The unit may not operate normally due to faulty handling or adverse power current effects caused by impact, excessive static electricity load, or power drop during use.

If this occurs, take the following measures.

- 1 Pull the AC adaptor out of the power outlet.
- 2 Remove the rechargeable battery.
- 3 Wait about 30 seconds.
- 4 Plug the AC adaptor into the power outlet and operate the unit.

To household outlet

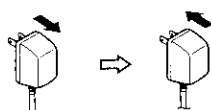

- AC adaptor may differ depending on the country or sales region.

## Specifications

System ..... Mini-disc digital audio system  
 Read method ..... Noncontact optical reading system (semiconductor laser)  
 Sampling frequency ..... 44.1 kHz  
 Audio compression ..... AT3AC (Adaptive Transform Acoustic Coding)  
 Number of channels ..... 2 channels  
 Frequency response ..... 20 Hz to 20,000 Hz (±3 dB)  
 Wow & flutter ..... Less than immeasurable limit (±0.001 % W/PEAK)  
 Input/Output terminal ..... Remote control/Phones jack  
 Rated power output ..... 9 mW+9 mW

### Power source

DC IN jack (4 - 5.1V)  
 : Specially provided AC adaptor  
 : Car battery adaptor (sold separately, DC-C70)  
 DC 1.5V : Commercially sold AA alkaline battery (LR-6) X 1  
 DC 1.2V : Specially provided rechargeable battery (NB-130) X 1  
 (Charging time : About 4 hours)

### Battery life (Fully charge, with "auto PS" setting ON)

Specially provided rechargeable battery (NB-130) X 1 ..... Approx. 5 hours  
 Commercially sold AA alkaline battery (LR-6) X 1 ..... Approx. 6 hours  
 • At 0.5mW+0.5mW output (32 Ω load).  
 • Standard value during continuous use/charging in an temperature of 25°C.  
 • Time of use may vary depending on battery maker, battery type, use environment, and temperature.  
 • Time will be shorter when "PS off" Mode is set.

### Dimensions (not including protruding parts)

W : 99 mm (3-7/8")  
 H : 17 mm (11/16")  
 D : 75 mm (2-15/16")

### Weight (Net)

115g (0.25 lb)  
 not including the accessory rechargeable battery  
 140g (0.31 lb)  
 including the accessory rechargeable battery



1. KENWOOD follows a policy of continuous advancements in development. For reason specifications may be changed without notice.
2. The full performance may not be exhibited in an extremely cold location (under a water-freezing temperature).

### For the U.S.A.

#### FCC WARNING:

This equipment may generate or use radio frequency energy. Changes or modifications to this equipment may cause harmful interference unless the modifications are expressly approved in the instruction manual. The user could lose the authority to operate this equipment if an unauthorized change or modification is made.

#### NOTE:

This equipment has been tested and found to comply with the limits for a Class B digital device, pursuant to Part 15 of the FCC Rules. These limits are designed to provide reasonable protection against harmful interference in a residential installation. This equipment may cause harmful interference to radio communications, if it is not installed and used in accordance with the instructions. However, there is no guarantee that interference will not occur in a particular installation. If this equipment does cause harmful interference to radio or television reception, which can be determined by turning the equipment off and on, the user is encouraged to try to correct the interference by one or more of the following measures:

- Reorient or relocate the receiving antenna.
- Increase the separation between the equipment and receiver.
- Connect the equipment into an outlet on a circuit different from that to which the receiver is connected.
- Consult the dealer or an experienced radio/TV technician for help

### For CANADA

#### Canadian IC Compliance Notice

NOTICE : This Class B digital apparatus meets all requirements of the Canadian interference-Causisg Equipment Regulations.

## Free Manuals Download Website

<http://myh66.com>

<http://usermanuals.us>

<http://www.somanuals.com>

<http://www.4manuals.cc>

<http://www.manual-lib.com>

<http://www.404manual.com>

<http://www.luxmanual.com>

<http://aubethermostatmanual.com>

Golf course search by state

<http://golfingnear.com>

Email search by domain

<http://emailbydomain.com>

Auto manuals search

<http://auto.somanuals.com>

TV manuals search

<http://tv.somanuals.com>