

# KENWOOD

## KRC-597

### CASSETTE RECEIVER INSTRUCTION MANUAL

KENWOOD CORPORATION



© B64-2715-00/00 (EW/E2W/EN/E2N)

## Contents

<b>Safety precautions.....3</b>	<b>Cassette player features..... 14</b>	<b>Menu system.....20</b>
<b>About Cassette tape.....4</b>	Playing Cassette Tapes	Menu System
<b>General features .....5</b>	Fast Forwarding and Rewinding	Security Code
Power	Dolby B NR	Touch Sensor Tone
Selecting the Source	Selecting the Tape type	Manual Clock Adjustment
Volume	DPSS (Direct Program Search System)	Synchronize Clock
System Q	Blank Skip	DSI (Disabled System Indicator)
Audio Control	Music Repeat	Selectable Illumination
Speaker Setting	<b>External disc control features..17</b>	Switching Display Type
Auxiliary Input Display Setting	Playing External Disc	Contrast Adjustment
Switching Display	Fast Forwarding and Reversing	News Bulletin with Timeout Setting
Theft Deterrent Faceplate	Track Search	Local Seek
TEL Mute	Disc Search	Tuning Mode
<b>Tuner features..... 10</b>	Track/Disc Repeat	Auto Memory Entry
Tuning	Scan Play	AF (Alternative Frequency)
Station Preset Memory	Random Play	Restricting RDS Region (Region Restrict Function)
Auto Memory Entry	Magazine Random Play	Auto TP Seek
Preset Tuning	Disc Naming (DNPS)	Monaural Reception
<b>RDS features..... 11</b>	Text/Title Scroll	Text Scroll
Traffic Information		Power OFF Timer
Radio Text Scroll		<b>Accessories .....26</b>
PTY (Program Type)		<b>Installation Procedure .....26</b>
Program Type preset		<b>Connecting Wires to Terminals 27</b>
Changing Language for PTY Function		<b>Installation .....29</b>
		<b>Troubleshooting Guide .....31</b>
		<b>Specifications .....34</b>

## Safety precautions

### **▲WARNING**

**To prevent injury and/or fire, take the following precautions:**

- Insert the unit all the way until it is fully locked in place. Otherwise it may fly out of place during collisions and other jolts.
- When extending the ignition, battery, or ground wires, make sure to use automotive-grade wires or other wires with a 0.75mm<sup>2</sup> (AWG18) or more to prevent wire deterioration and damage to the wire coating.
- To prevent short circuits, never put or leave any metallic objects (e.g., coins or metal tools) inside the unit.
- If the unit starts to emit smoke or strange smells, turn off the power immediately and consult your Kenwood dealer.
- Make sure not to get your fingers caught between the faceplate and the unit.
- Be careful not to drop the unit or subject it to strong shock.  
The unit may break or crack because it contains glass parts.
- Do not touch the liquid crystal fluid if the LCD is damaged or broken due to shock. The liquid crystal fluid may be dangerous to your health or even fatal.  
If the liquid crystal fluid from the LCD contacts your body or clothing, wash it off with soap immediately.

### **▲CAUTION**

**To prevent damage to the machine, take the following precautions:**

- Make sure to ground the unit to a negative 12V DC power supply.
- Do not open the top or bottom covers of the unit.
- Do not install the unit in a spot exposed to direct sunlight or excessive heat or humidity. Also avoid places with too much dust or the possibility of water splashing.
- Do not set the removed faceplate or the faceplate case in areas exposed to direct sunlight, excessive heat or humidity. Also avoid places with too much dust or the possibility of water splashing.
- To prevent deterioration, do not touch the terminals of the unit or faceplate with your fingers.
- Do not subject the faceplate to excessive shock, as it is a piece of precision equipment.
- When replacing a fuse, only use a new one with the prescribed rating. Using a fuse with the wrong rating may cause your unit to malfunction.
- To prevent short circuits when replacing a fuse, first disconnect the wiring harness.
- Do not place any object between the faceplate and the unit.
- During installation, do not use any screws except for the ones provided. The use of improper screws might result in damage to the main unit.

### **IMPORTANT INFORMATION**

**About CD players/disc changers connected to this unit**

KENWOOD disc changers/ CD players released in 1998 or later can be connected to this unit.

Refer to the catalog or consult your Kenwood dealer for connectable models of disc changers/ CD players.

Note that any KENWOOD disc changers/ CD players released in 1997 or earlier and disc changers made by other makers cannot be connected to this unit.

Unsupported connection may result in damage.

Setting the "O-N" Switch to the "N" position for the applicable KENWOOD disc changers/ CD players.

The functions that can be used and the information that can be displayed will differ depending on the models being connected.



You can damage both your unit and the CD changer if you connect them incorrectly.

*Manufactured under license from Dolby Laboratories.  
"Dolby" and the double-D symbol are trademarks of Dolby Laboratories.*

## Safety precautions

### NOTE

- If you experience problems during installation, consult your Kenwood dealer.
- If the unit does not seem to be working right, try pressing the reset button first. If that does not solve the problem, consult your Kenwood dealer.
- Press the reset button if the Disc auto changer fails to operate correctly. Normal operation should be restored.

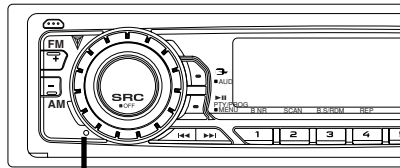

Reset button

- Characters in the LCD may become difficult to read in temperatures below 41 °F (5 °C).
- The illustrations of the display and the panel appearing in this manual are examples used to explain more clearly how the controls are used. Therefore, what appears on the display in the illustrations may differ from what appears on the display on the actual equipment, and some of the illustrations on the display may represent something impossible in actual operation.

### Cleaning the Faceplate Terminals

If the terminals on the unit or faceplate get dirty, wipe them with a dry, soft cloth.

### Cleaning the Unit

If the faceplate of this unit is stained, wipe it with a dry soft cloth such as a silicon cloth. If the faceplate is stained badly, wipe the stain off with a cloth moistened with neutral cleaner, then wipe neutral detergent off.

- ⚠ Applying spray cleaner directly to the unit may affect its mechanical parts. Wiping the faceplate with a hard cloth or using a volatile liquid such as thinner or alcohol may scratch the surface or erase characters.

This Product is not installed by the manufacturer of a vehicle on the production line, nor by the professional importer of a vehicle into an EU Member State.

## About Cassette tape

### Cleaning the tape head

When there's noise or the sound quality is bad during tape play the tape head maybe dirty, clean the tape head.

### About Cassette tape

- If the tape is slack tighten it.
- If the cassette tape label is peeling off glue it on again.
- Don't use deformed cassette tape.
- Don't place cassette tape on the dashboard etc. where the temperature is high.
- Don't use cassette tape that's 100 minutes long or longer.

## General features

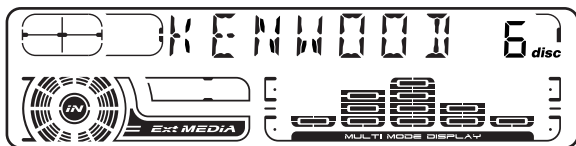
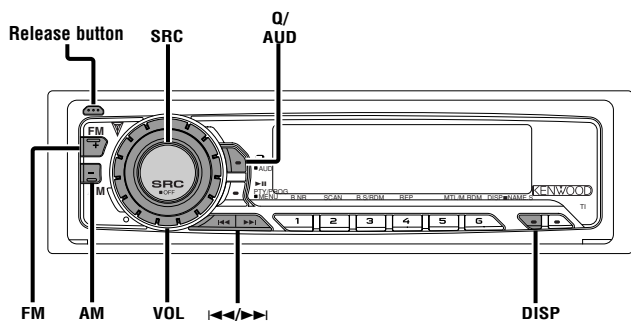

## Power

### Turning ON the Power

Press the [SRC] button.



When the power is ON, the <Security Code> (page 20) is displayed as "CODE ON" or "CODE OFF".

### Turning OFF the Power

Press the [SRC] button for at least 1 second.

## Selecting the Source

Press the [SRC] button.

Source required	Display
Tuner	"TUNER"
Tape	"TAPE"
External disc (Optional accessory)	"DISC CH"/"CD"
Auxiliary input (Optional accessory)	"AUX1"
Standby (Illumination only mode)	"ALL OFF"



This unit automatically turns full power OFF after 20 minutes lapses in Standby mode in order to save the vehicles battery.

The time until full power OFF can be set in <Power OFF Timer> (page 25).

## General features

### Volume

#### Increasing Volume

Turn the [VOL] knob clockwise.

#### Decreasing Volume

Turn the [VOL] knob counterclockwise.

### System Q

You can recall the best sound setting preset for different types of music.

#### 1 Select the source to set

Press the [SRC] button.

#### 2 Select the Sound type

Press the [Q] button.

Each time the button is pressed the sound setting switches.

Sound setting	Display
Flat	"FLAT"
User memory	"USER"
Rock	"ROCK"
Pops	"POPS"
Easy	"EASY"
Top 40	"TOP40"
Jazz	"JAZZ"



- User memory: The values set on the <Audio control> (page 6).
- Each setting value is changed with the <Speaker setting> (page 7).

First, select the speaker type with the Speaker setting.

### Audio Control

#### 1 Select the source for adjustment

Press the [SRC] button.

#### 2 Enter Audio Control mode

Press the [AUD] button for at least 1 second.

#### 3 Select the Audio item for adjustment

Press the [FM] or [AM] button.

Each time the button is pressed the items that can be adjusted switch as shown below.

#### 4 Adjust the Audio item

Press the [◀] or [▶] button.

Adjustment Item	Display	Range
Bass level	"BAS"	-8 — +8
Middle level	"MID"	-8 — +8
Treble level	"TRE"	-8 — +8
Balance	"BAL"	Left 15 — Right 15
Fader	"FAD"	Rear 15 — Front 15
Volume offset	"V-OFF"	-8 — ±0
Loudness	"LOUD"	ON/OFF



- Volume offset: Each source's volume can be set as a difference from the basic volume.
- Loudness: Compensating for low and high tones during low volume.

#### 5 Exit Audio Control mode

Press the [AUD] button.

## Speaker Setting

Fine-tuning so that the System Q value is optimal when setting the speaker type.

### 1 Enter Standby

Press the [SRC] button.  
Select the "ALL OFF" display.

### 2 Enter Speaker Setting mode

Press the [Q] button.

### 3 Select the Speaker type

Press the [◀◀] or [▶▶] button.

Each time the button is pressed the setting switches as shown below.

Speaker type	Display
OFF	"SP OFF"
For 5 & 4 in. speaker	"SP 5/4"
For 6 & 6x9 in. speaker	"SP 6*9/6"
For the OEM speaker	"SP OEM"

### 4 Exit Speaker Setting mode

Press the [Q] button.

The presently selected AUX Name is blinks.

### 3 Select the Auxiliary input display

Press the [◀◀] or [▶▶] button.

Each time the button is pressed it switches through the below displays.

- "AUX1"
- "TV"
- "VIDEO"
- "GAME"
- "PORTABLE"
- "DVD"

### 4 Exit Auxiliary input display setting mode

Press the [DISP] button.



When operation stops for 10 seconds, the name at that time is selected, and Auxiliary input display setting mode closes.

## Auxiliary Input Display Setting

Selecting the display when this device is switched to Auxiliary input source.

### 1 Select Auxiliary input source

Press the [SRC] button.  
Select the "AUX1" display.

### 2 Enter Auxiliary input display setting mode

Press the [DISP] button for at least 2 seconds.

## General features

### Switching Display

Switching the information displayed.

Press the [DISP] button.

Each time the button is pressed the display switches as shown below.

#### In Tuner source

Information	Display
Program Service name or Frequency	
Radio text,	"R-TEXT"
Program Service name or Frequency	
Clock	

#### Displaying the frequency during Program Service name reception

Press the [DISP] button for at least 1 second.

The frequency for the RDS station will be displayed for 5 seconds instead of the Program Service name.

#### In Tape source

Information	Display
Play side	
Tape running & Tape counter	
Tape running	
Clock	

#### In External disc source

Information	Display
Disc title	"D-TITLE"
Track title	"T-TITLE"
Track number & Play time	"P-TIME"
Disc name	"DNPS"
Clock	

### In Auxiliary input source

#### Information

Auxiliary input name

Clock



If the Disc title or Track title is selected when the disc which does not have disc title or track title is played, track number and play time are displayed.

### Theft Deterrent Faceplate

The faceplate of the unit can be detached and taken with you, helping to deter theft.

#### Removing the Faceplate

- 1 Press the Release button.  
Drop open the faceplate.
- 2 Drawing the faceplate to left side pull it to the front and remove it.

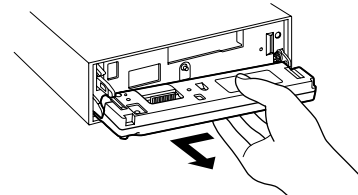

- The faceplate is a precision piece of equipment and can be damaged by shocks or jolts. For that reason, keep the faceplate in its special storage case while detached.
- Do not expose the faceplate or its storage case to direct sunlight or excessive heat or humidity. Also avoid places with too much dust or the possibility of water splashing.



### **Reattaching the Faceplate**

- 1** Align the shaft on the unit with the depression on the faceplate.

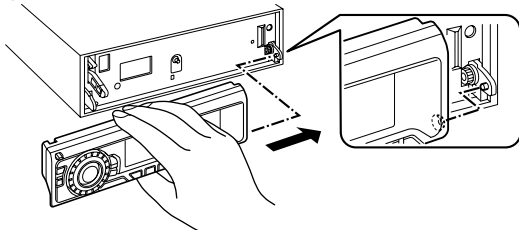

- 2** Push the faceplate in until it clicks.  
The faceplate is locked in place, allowing you to use the unit.

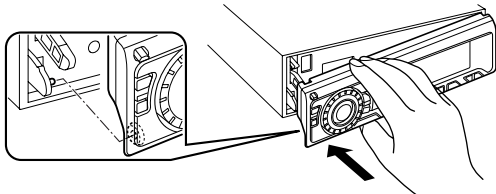

### **TEL Mute**

The audio system automatically mutes when a call comes in.

#### ***When a call comes in***

"CALL" is displayed.

The audio system pauses.

#### ***Listening to the audio during a call***

Press the [SRC] button.

The "CALL" display disappears and the audio system comes back ON.

#### ***When the call ends***

Hang up the phone.

The "CALL" display disappears and the audio system comes back ON.

## Tuner features

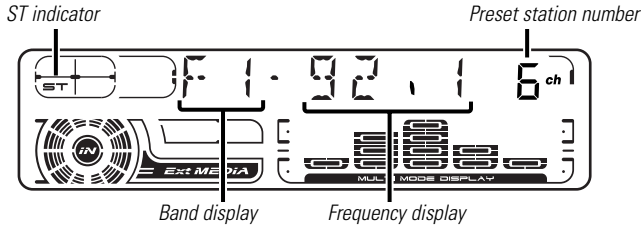
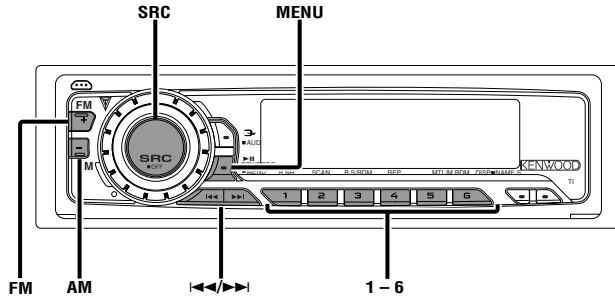

## Tuning

Selecting the station.

### 1 Select tuner source

Press the [SRC] button.  
Select the "TUNER" display.

### 2 Select the band

Press the [FM] or [AM] button.  
Each time the [FM] button is pressed it switches between the FM1, FM2, and FM3 bands.

### 3 Tune up or down band

Press the [◀◀] or [▶▶] button.



During reception of stereo stations the "ST" indicator is ON.

## Station Preset Memory

Putting the station in the memory.

### 1 Select the band

Press the [FM] or [AM] button.

### 2 Select the frequency to put in the memory

Press the [◀◀] or [▶▶] button.

### 3 Put the frequency in the memory

Press the desired [1] — [6] button for at least 2 seconds.

The preset number display blinks 1 time.

On each band, 1 station can be put in the memory on each [1] — [6] button.

## RDS features

### Auto Memory Entry

Putting a station with good reception in the memory automatically.

#### 1 Select the band for Auto Memory Entry

Press the [FM] or [AM] button.

#### 2 Enter Menu mode

Press the [MENU] button for at least 1 second.

"MENU" is displayed.

#### 3 Select the Auto Memory Entry mode

Press the [FM] or [AM] button.

Select the "A-MEMORY" display.

#### 4 Open Auto Memory Entry

Press the [◀◀] or [▶▶] button for at least 2 seconds.

When 6 stations that can be received are put in the memory Auto Memory Entry closes.



- When the <AF (Alternative Frequency)> (page 24) is ON, only RDS stations are put in the memory.
- When Auto Memory Entry is done in the FM2 band, the RDS stations preset in the FM1 band aren't put in the memory. Likewise, when it is done in the FM3 band, RDS stations preset in FM1 or FM2 aren't put in the memory.

### Preset Tuning

Calling up the stations in the memory.

#### 1 Select the band

Press the [FM] or [AM] button.

#### 2 Call up the station

Press the desired [1] — [6] button.

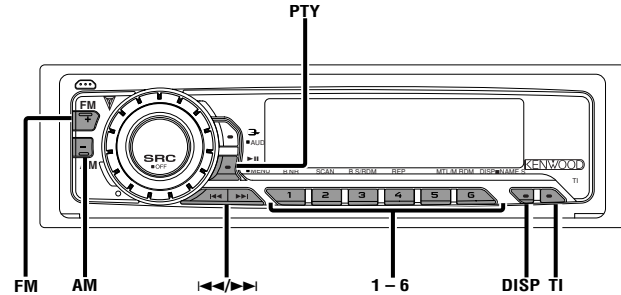

PTY indicator

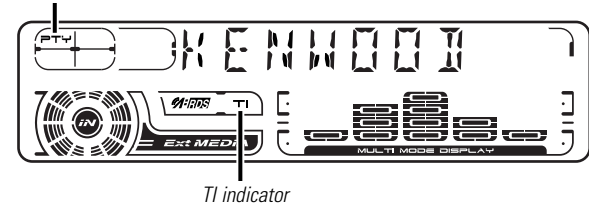

## RDS features

### Traffic Information

Switching to traffic information automatically when a traffic bulletin starts even when you aren't listening to the radio.

Press the [TI] button.

Each time the button is pressed the Traffic Information function turns ON or OFF.

When it's ON, "TI" indicator is ON.

When a traffic information station isn't being received the "TI" indicator blinks.

When a traffic bulletin starts, "TRAFFIC" is displayed it and it switches to traffic information.



- During reception of an AM station when the Traffic Information function is turned ON, it switches to an FM station.
- During reception of traffic information the adjusted volume is automatically remembered, and the next time it switches to traffic information it's automatically the remembered volume.

### Receiving other traffic information stations

Press the [◀◀] or [▶▶] button.



Traffic information station switching can be done when listening to the radio.

### Radio Text Scroll

Scrolling the displayed radio text.

Press the [DISP] button for at least 1 second.

### PTY (Program Type)

Selecting the Program Type and searching for a station.

#### 1 Enter PTY mode

Press the [PTY] button.

During PTY mode the "PTY" indicator is ON.



This function can't be used during a traffic bulletin or AM reception.

#### 2 Select the Program Type

Press the [FM] or [AM] button.

Each time the button is pressed the Program Type switches as shown below.

No.	Program Type	Display
1.	Speech	"SPEECH"
2.	Music	"MUSIC"
3.	News	"NEWS"
4.	Current Affairs	"AFFAIRS"
5.	Information	"INFO"
6.	Sport	"SPORT"
7.	Education	"EDUCATE"
8.	Drama	"DRAMA"
9.	Culture	"CULTURE"
10.	Science	"SCIENCE"
11.	Varied	"VARIED"
12.	Pop Music	"POP M"
13.	Rock Music	"ROCK M"
14.	Easy Listening Music	"EASY M"
15.	Light Classical	"LIGHT M"
16.	Serious Classical	"CLASSICS"
17.	Other Music	"OTHER M"
18.	Weather	"WEATHER"
19.	Finance	"FINANCE"
20.	Children's programs	"CHILDREN"

21. Social Affairs	"SOCIAL"
22. Religion	"RELIGION"
23. Phone In	"PHONE IN"
24. Travel	"TRAVEL"
25. Leisure	"LEISURE"
26. Jazz Music	"JAZZ"
27. Country Music	"COUNTRY"
28. National Music	"NATION M"
29. Oldies Music	"OLDIES"
30. Folk Music	"FOLK M"
31. Documentary	"DOCUMENT"



- Speech and Music include the Program type shown below.

Music: No.12 — 17, 26 — 30

Speech: No.3 — 11, 18 — 25, 31

- The Program Type can be put in the [1] — [6] button memory and called up quickly. Refer to the <Program Type preset> (page 13).
- The display language can be changed. Refer to <Changing Language for PTY Function> (page 14).

### 3 Search for the selected Program Type station

Press the [◀◀] or [▶▶] button.

When you want to search for other stations press the [◀◀] or [▶▶] button again.



When the selected Program Type isn't found, "NO PTY" is displayed. Select another Program Type.

### 4 Exit PTY mode

Press the [PTY] button.

## Program Type preset

Putting the Program Type in the Preset button memory and calling it up quickly.

### Presetting the Program Type

#### 1 Select the Program Type to preset

Refer to <PTY (Program Type)> (page 12).

#### 2 Preset the Program Type

Press the desired [1] — [6] button for at least 2 seconds.

### Calling up the preset Program Type

#### 1 Enter PTY mode

Refer to <PTY (Program Type)> (page 12).

#### 2 Call up the Program Type

Press the desired [1] — [6] button.

## RDS features

### Changing Language for PTY Function

Selecting the Program Type display language.

#### 1 Enter PTY mode

Refer to <PTY (Program Type)> (page 12).

#### 2 Enter Changing Language mode

Press the [DISP] button.

#### 3 Select the language

Press the [FM] or [AM] button.

Each time the button is pressed the language switches as shown below.

Language	Display
English	"ENGLISH"
French	"FRENCH"
Swedish	"SWEDISH"
German	"GERMAN"

#### 4 Exit Changing Language mode

Press the [DISP] button.

## Cassette player features

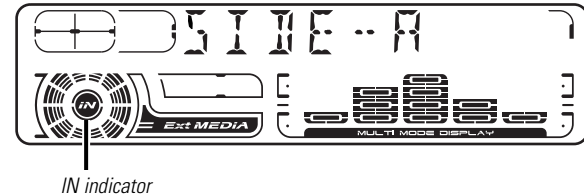
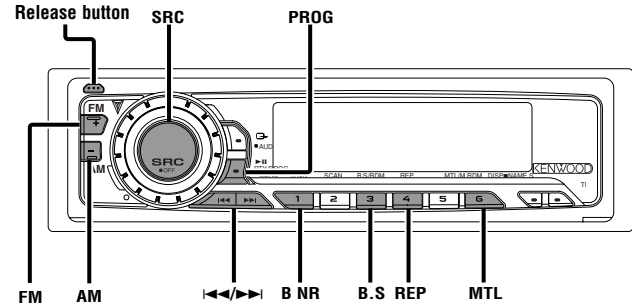

## Playing Cassette Tapes

### **When there's no Cassette Tape inserted**

#### **1 Drop open the faceplate**

Press the Release button.

#### **2 Insert a Cassette Tape.**

#### **3 Press the faceplate on the left side, and return it to its former position.**



- When the faceplate has been dropped open, it might interfere with the shift lever or something else. If this happens, pay attention to safety and move the shift lever or take an appropriate action, then operate the unit.
- Do not use the unit with the faceplate in the open condition. If it's used in the open position dust can enter the inside part and cause damage.



When there's a Cassette Tape inserted, the "IN" indicator is ON.

### **When there's a Cassette Tape inserted**

Press the [SRC] button.

Select the "TAPE" display.

### **When you want to listen to the reverse side**

Press the [PROG] button.

### **Eject the Cassette Tape**

#### **1 Drop open the faceplate**

Press the Release button.

#### **2 Eject the Cassette Tape**

Press the [▲] button.

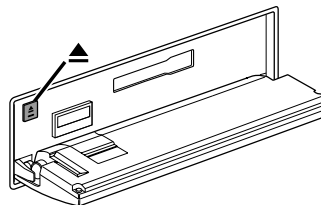

#### **3 Press the faceplate on the left side, and return it to its former position.**

## Fast Forwarding and Rewinding

### **Fast Forwarding**

Press the [FM] button.

When it's stopped press the [PROG] button.

### **Rewinding**

Press the [AM] button.

When it's stopped press the [PROG] button.

## Dolby B NR

Press the [B NR] button.

Each time the button is pressed the Dolby B NR turns ON or OFF.

When it's ON, "B-NR" is displayed.

## Cassette player features

### Selecting the Tape type

Press the [MTL] button.

Each time the button is pressed the Tape type switches as shown below.

Tape type	Display
CrO <sub>2</sub> (Type II), FeCr (Type III), Metal (Type IV)	"MTL ON"
Normal (Type I)	"MTL OFF"

### DPSS (Direct Program Search System)

Indicating the songs to skip, and Fast Forwarding or Rewinding.

#### Skipping to a later song

Press the [▶▶] button.

Each time the button is pressed the number of songs skipped increases.

#### Skipping to a previous song

Press the [◀◀] button.

Each time the button is pressed the number of songs skipped increases.

#### Canceling DPSS

Press the [PROG] button.



- During the songs first 5 seconds the previous song may be recognized as the current song.
- As many as 9 songs can be skipped.

### Blank Skip

Fast forwarding automatically when an unrecorded portion continues for at least 10 seconds.

Press the [B.S] button.

Each time the button is pressed the Blank Skip turns ON or OFF. When it's ON, "BS ON" is displayed.

### Music Repeat

Repeating the present song.

Press the [REP] button.

Each time the button is pressed the Music Repeat turns ON or OFF.

When it's ON, "REP ON" is displayed.



## External disc control features

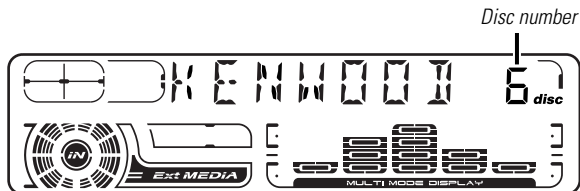
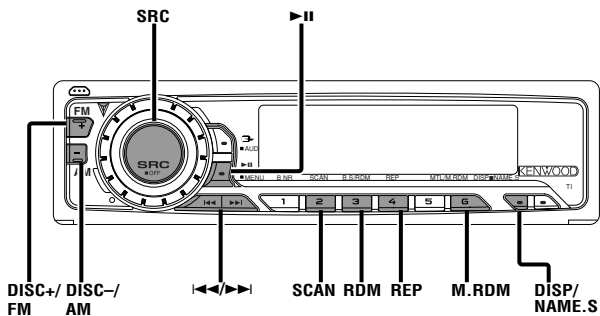

### Playing External Disc

Playing discs set in the optional accessory disc player connected to this unit.

Press the [SRC] button.

Select the display for the disc player you want.

Display examples:

Display	Disc player
"CD"	CD player
"DISC CH"	CD changer/ MD changer

### Pause and play

Press the [▶||] button.

Each time the button is pressed it pauses and plays.



- Disc 10 is displayed as "0".
- The functions that can be used and the information that can be displayed will differ depending on the external disc players being connected.

### Fast Forwarding and Reversing

#### Fast Forwarding

Hold down on the [▶▶] button.

Release your finger to play the disc at that point.

#### Reversing

Hold down on the [◀◀] button.

Release your finger to play the disc at that point.

## External disc control features

### Track Search

Selecting the song you want to hear.

Press the [◀◀] or [▶▶] button.

### Disc Search (Function of disc changer)

Selecting the disc you want to hear.

Press the [DISC-] or [DISC+] button.

### Track/Disc Repeat

Replaying the track/disc you're listening to.

Press the [REP] button.

Each time the button is pressed the Repeat Play switches as shown below.

Repeat play	Display
Track Repeat	"(T-)REP ON"
Disc Repeat (Function of disc changer)	"D-REP ON"
OFF	"REP OFF"

### Scan Play

Playing the first part of each song on the disc you are listening to and searching for the song you want to listen to.

#### 1 Start Scan Play

Press the [SCAN] button.

"SCAN ON" is displayed.

#### 2 Release it when the song you want to listen to is played

Press the [SCAN] button.

### Random Play

Playing all the songs on the disc in random order.

Press the [RDM] button.

Each time the button is pressed Random Play turns ON or OFF.

When it's ON, "RDM ON" is displayed.



When the [▶▶] button is pressed, the next song select starts.

### Magazine Random Play (Function of disc changer)

Play the songs on all the discs in the disc changer in random order.

Press the [M.RDM] button.

Each time the button is pressed the Magazine Random Play turns ON or OFF.

When it's ON, "MRDM ON" is displayed.



When the [▶▶] button is pressed, the next song select starts.

## Disc Naming (DNPS)

Attaching a title to a CD.

### 1 Play the disc you want to attach a name to



- A title can't be attached to a MD.
- Refer to the <Switching Display> (page 8) and select the "DNPS" display.

### 2 Enter name set mode

Press the [NAME.S] button for at least 2 seconds.  
"NAME SET" is displayed.

### 3 Move the cursor to the enter character position

Press the [◀◀] or [▶▶] button.

### 4 Select the characters

Press the [FM] or [AM] button.

### 5 Repeat steps 3 through 4 and enter the name.

### 6 Exit name set mode

Press the [NAME.S] button.



- When operation stops for 10 seconds the name at that time is registered, and Name Set mode closes.
- Media that you can attach names to
  - External CD changer/ player: Varies according to the CD changer/ player. Refer to the CD changer/ player manual.
- The name of a CD can be changed by the same operation you used to name it.

## Text/Title Scroll

Scrolling the displayed CD text or MD title.

Press the [DISP] button for at least 1 second.

## Menu system

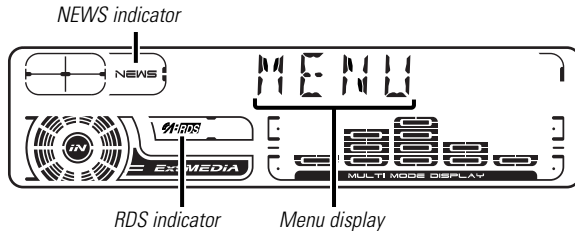
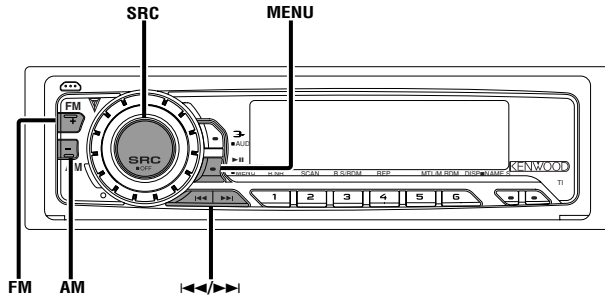

## Menu System

Setting during operation beep sound etc. functions. The Menu system basic operation method is explained here. The reference for the Menu items and their setting content is after this operation explanation.

### 1 Enter Menu mode

Press the [MENU] button for at least 1 second.  
"MENU" is displayed.

### 2 Select the menu item

Press the [FM] or [AM] button.

Example: When you want to set the beep sound select the "BEEP" display.

### 3 Set the menu item

Press the [◀◀] or [▶▶] button.

Example: When "BEEP" is selected, each time the button is pressed it switches "BEEP ON" or "BEEP OFF". Select 1 of them as the setting.

You can continue by returning to step 2 and setting other items.

### 4 Exit Menu mode

Press the [MENU] button.



When other items that are applicable to the basic operation method above are displayed afterwards their setting content chart is entered. (Normally the uppermost setting in the chart is the original setting.)

Also, the explanation for items that aren't applicable (<Manual Clock Adjustment>etc.) are entered step by step.

## Security Code

## <In Standby mode>

Because authorization by the Security Code is required when it's removed from the vehicle, personalizing this unit is by using the Security Code is a help in preventing theft.



When the Security Code function is activated it can't be released.  
Note, your Security Code is the 4 digit number entered in your "Car Audio Passport" in this package.

### 1 Enter Standby

Press the [SRC] button.

Select the "ALL OFF" display.

### 2 Enter Menu mode

Press the [MENU] button for at least 1 second.

When "MENU" is displayed, "SECURITY" is displayed.

### 3 Enter Security Code mode

Press the [◀◀] or [▶▶] button for at least 1 second.

When "ENTER" is displayed, "CODE" is displayed.

### 4 Select the digits to enter

Press the [◀◀] or [▶▶] button.

### 5 Select the Security Code numbers

Press the [FM] or [AM] button.

### 6 Repeat steps 4 and 5, and complete the Security Code.

### 7 Confirm the Security Code

Press the [▶▶] button for at least 3 seconds.

When "RE-ENTER" is displayed, "CODE" is displayed.

### 8 Do the step 4 through 7 step operation, and reenter the security code.

"APPROVED" is displayed.

The Security Code function activates.



If you enter a Code different from your Security Code, you have to start over from step 4.

**Press the Reset button and when it's removed from the battery power source**

### 1 Turn the power ON.

## 2 Do the step 4 through 7 step operation, and reenter the security code.

"APPROVED" is displayed.

The unit can be used.



If an incorrect code is input, "WAITING" is displayed, and the input prohibited time shown below is generated.

After the input prohibited time lapses, "CODE" is displayed, and input can be done.

Number of times the incorrect code was input	Input prohibited time
1	—
2	5 minutes
3	1 hour
4	24 hours

## Touch Sensor Tone

Setting the operation check sound (beep sound) ON/OFF.

Display	Setting
"BEEP ON"	Beep is heard.
"BEEP OFF"	Beep canceled.

## Menu system

### Manual Clock Adjustment

 This adjustment can be done when the <Synchronize Clock> (page 22) is set as OFF.

#### 1 Select Clock Adjustment mode

Press the [FM] or [AM] button.  
Select the "CLK ADJ" display.

#### 2 Enter Clock Adjust mode

Press the [◀◀] or [▶▶] button for at least 1 second.  
The clock display blinks.

#### 3 Adjust the hours

Press the [FM] or [AM] button.

#### Adjust the minutes

Press the [◀◀] or [▶▶] button.

#### 4 Exit Clock adjustment mode

Press the [MENU] button.

### Synchronize Clock

Synchronizing the RDS station time data and this unit's clock.

Display	Setting
"SYNC ON"	Synchronizes the time.
"SYNC OFF"	Adjust the time manually.

 It takes 3 to 4 minutes to synchronize the clock.

### DSI (Disabled System Indicator)

A red indicator will blink on the unit after the faceplate is removed, warning potential thieves.

Display	Setting
"DSI ON"	LED flashes.
"DSI OFF"	LED OFF.

### Selectable Illumination

Selecting the button illumination color as green or red.

Display	Setting
"KEY RED"	The illumination color is red.
"KEY GRN"	The illumination color is green.

### Switching Display Type

Setting the Display type.

Display	Setting
"DISP C"	Demonstration.
"DISP A"	Normal display type.
"DISP B"	Silent display type.

### Contrast Adjustment

Adjusting the display contrast.

### Display and Setting

"CONT 0"

:

"CONT 7" (Original setting)

### News Bulletin with Timeout Setting

It switches automatically when a news bulletin starts even if the radio isn't being listened to. Also, the time interval when interrupt is prohibited can be set.

#### Display and Setting

"NEWS OFF"

"NEWS 00M"

:

"NEWS 90M"

When "NEWS 00M" — "NEWS 90M" is set, the News Bulletin Interrupt function is ON.

When it's ON, the "NEWS" indicator is ON.

When the news bulletin starts, "NEWS" is displayed, and it switches to the news bulletin.



- If you choose the "20M" setting, further news bulletins will not be received for 20 minutes once the first news bulletin is received.
- The news bulletin volume is the same level that was set for <Traffic Information> (page 12).
- This function is only available if the desired station sends PTY-code for news bulletin or belongs to <Enhanced Other Network>-Network sending PTY-code for news bulletin.
- When the News Bulletin Interrupt function is ON, it switches to an FM station.

### Local Seek

<In Tuner mode>

Only stations whose reception is good are searched for in auto seek tuning.

#### Display

#### Setting

"LO.S OFF"

The local seek function is OFF.

"LO.S ON"

The local seek function is ON.

### Tuning Mode

<In Tuner mode>

Sets the tuning mode.

#### Tuning mode

#### Display

#### Operation

Auto seek

"AUTO 1"

Automatic search for a station.

Preset station seek

"AUTO 2"

Search in order of the stations in the Preset memory.

Manual

"MANUAL"

Normal manual tuning control.

### Auto Memory Entry

<In Tuner mode>

For the operation method refer to <Auto Memory Entry> (page 11).

## Menu system

### AF (Alternative Frequency)

When poor reception is experienced, automatically switch to another frequency broadcasting the same program in the same RDS network with better reception.

Display	Setting
"AF ON"	The AF function is ON.
"AF OFF"	The AF function is OFF.

When the AF function is ON, the "RDS" indicator is ON.

 When no other stations with stronger reception are available for the same program in the RDS network, you may hear the incoming broadcast in bits and snatches. Turn OFF the AF function in such a case.

### Restricting RDS Region (Region Restrict Function)

You can choose whether or not to restrict the RDS channels, received with the AF function for a particular network, to a specific region.

Display	Setting
"REG ON"	The Region Restrict Function is ON.
"REG OFF"	The Region Restrict Function is OFF.

 Sometimes stations in the same network broadcast different programs or use different program service names.

### Auto TP Seek

When the TI function is ON and poor reception conditions are experienced when listening to a traffic information station, another traffic information station with better reception will be searched for automatically.

Display	Setting
"ATPS ON"	The Auto TP Seek Function is ON.
"ATPS OFF"	The Auto TP Seek Function is OFF.

### Monaural Reception <In FM reception>

Noise can be reduced when stereo broadcasts are received as monaural.

Display	Setting
"MONO OFF"	The monaural reception is OFF.
"MONO ON"	The monaural reception is ON.

### Text Scroll

Setting the displayed text scroll.

Display	Setting
"SCL MANU"	Doesn't scroll.
"SCL AUTO"	Scrolls when the display changes.

 The text scrolled is shown below.

- CD text
- MD title
- Radio text



## Power OFF Timer

Setting the timer to turn this unit's power OFF automatically when Standby mode continues.

Using this setting can save the vehicle's battery power.

Display	Setting
"OFF -- --"	Power OFF Timer function is OFF.
"OFF 20M" (Original setting)	Turns the power OFF after 20 minutes.
"OFF 40M"	Turns the power OFF after 40 minutes.
"OFF 60M"	Turns the power OFF after 60 minutes.



This setting is done after setting <Security Code> (page 20).

## Accessories

### External view

..... Number of items

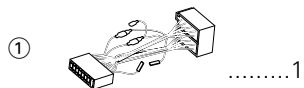

### External view

..... Number of items



The use of any accessories except for those provided might result in damage to the unit. Make sure only to use the accessories shipped with the unit, as shown above.

## Installation Procedure

1. To prevent short circuits, remove the key from the ignition and disconnect the  $\ominus$  terminal of the battery.
2. Make the proper input and output wire connections for each unit.
3. Connect the wire on the wiring harness.
4. Take Connector B on the wiring harness and connect it to the speaker connector in your vehicle.
5. Take Connector A on the wiring harness and connect it to the external power connector on your vehicle.
6. Connect the wiring harness connector to the unit.
7. Install the unit in your car.
8. Reconnect the  $\ominus$  terminal of the battery.
9. Press the reset button.

### ▲CAUTION

- If your car is not prepared for this special connection-system, consult your Kenwood dealer.
- Only use antenna conversion adapters (ISO-JASO) when the antenna cord has an ISO plug.
- Make sure that all wire connections are securely made by inserting jacks until they lock completely.
- If your vehicle's ignition does not have an ACC position, or if the ignition wire is connected to a power source with constant voltage such as a battery wire, the power will not be linked with the ignition (i.e., it will not turn on and off along with the ignition). If you want to link the unit's power with the ignition, connect the ignition wire to a power source that can be turned on and off with the ignition key.
- If the fuse blows, first make sure that the wires have not caused a short circuit, then replace the old fuse with one with the same rating.
- Insulate unconnected wires with vinyl tape or other similar material. To prevent short circuits, also do not remove the caps on the ends of the unconnected wires or the terminals.
- Connect the speaker wires correctly to the terminals to which they correspond. The unit may receive damage or fail to work if you share the  $\ominus$  wires and/or ground them to any metal part in the car.
- After the unit is installed, check whether the brake lamps, indicators, wipers, etc. on the car are working properly.
- If the console has a lid, make sure to install the unit so that the faceplate does not hit the lid when closing and opening.

# Connecting Wires to Terminals

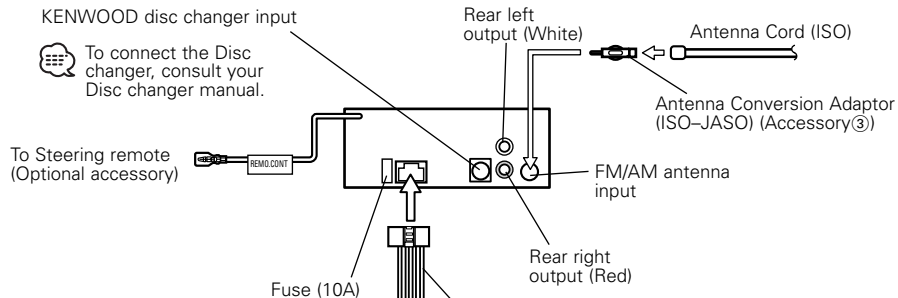

## Connector Function Guide

Pin Numbers for ISO Connectors	Cable Color	Functions
<b>External Power Connector</b>		
A-4	Yellow	Battery
A-5	Blue/White	Power Control
A-7	Red	Ignition (ACC)
A-8	Black	Earth (Ground) Connection
<b>Speaker Connector</b>		
B-1	Purple	Rear Right (+)
B-2	Purple/Black	Rear Right (-)
B-3	Gray	Front Right (+)
B-4	Gray/Black	Front Right (-)
B-5	White	Front Left (+)
B-6	White/Black	Front Left (-)
B-7	Green	Rear Left (+)
B-8	Green/Black	Rear Left (-)

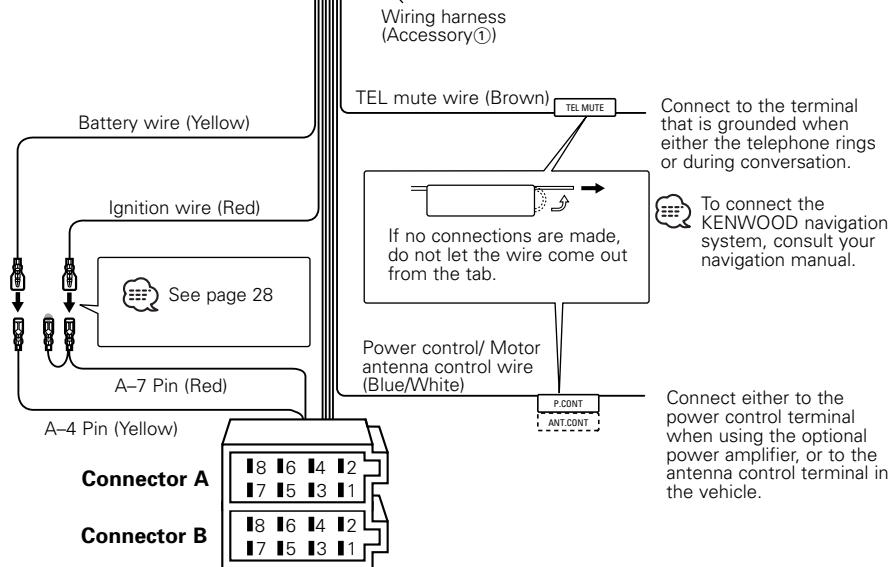

## Connecting Wires to Terminals

### **▲WARNING** Connecting the ISO Connector

The pin arrangement for the ISO connectors depends on the type of vehicle you drive. Make sure to make the proper connections to prevent damage to the unit.

The default connection for the wiring harness is described in [1] below. If the ISO connector pins are set as described in [2] or [3], make the connection as illustrated.

Please be sure to reconnect the cable as shown [2] below to install this unit to the **Volkswagen** vehicles etc.



When the connection is made as in [3] above, the unit's power will not be linked to the ignition key. For that reason, always make sure to turn off the unit's power when the ignition is turned off.

To link the unit's power to the ignition, connect the ignition cable (ACC...red) to a power source that can be turned on and off with the ignition key.

- [1] (Default setting) The A-7 pin (red) of the vehicle's ISO connector is linked with the ignition, and the A-4 pin (yellow) is connected to the constant power supply.

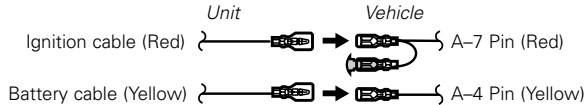

- [2] The A-7 pin (red) of the vehicle's ISO connector is connected to the constant power supply, and the A-4 pin (yellow) is linked to the ignition.

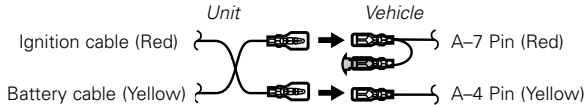

- [3] The A-4 pin (yellow) of the vehicle's ISO connector is not connected to anything, while the A-7 pin (red) is connected to the constant power supply (or both the A-7 (red) and A-4 (yellow) pins are connected to the constant power supply).

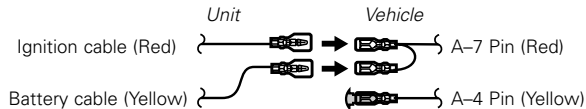

# Installation

## ■ Installation

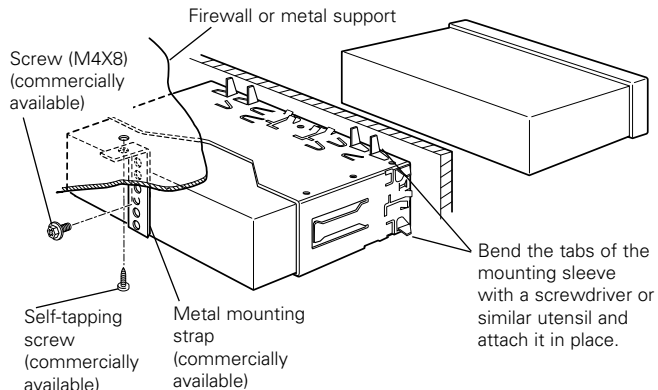

Make sure that the unit is installed securely in place. If the unit is unstable, it may malfunction (eg, the sound may skip).

## ■ Screwing the Faceplate on the Unit

If you want to fasten the faceplate to the main unit so that it does not fall off.

- 1 Refer to the section <Removing the hard rubber frame> and then remove the hard rubber frame.
- 2 Drop open the faceplate by pressing the Release button.

- 3 Tighten the screw ( $\varnothing 2.6 \times 12$  mm) (Accessory ④) in the hole shown on the diagram.

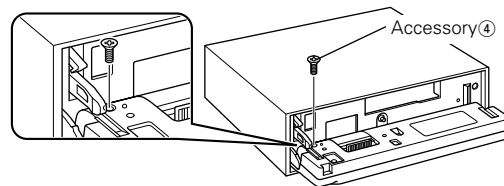

- 4 Tighten the screw ( $\varnothing 2 \times 4$  mm) (Accessory ⑤) in the hole shown on the diagram.

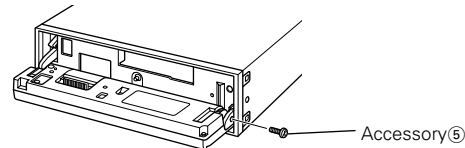

- 5 Tighten the screws ( $\varnothing 2 \times 6$  mm) (Accessory ⑥) in the holes shown on the diagram.

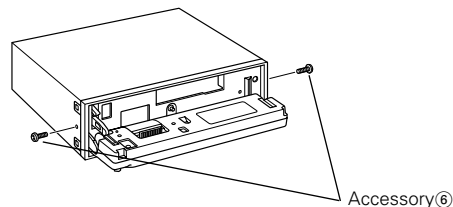

⚠ Never insert the screws in any other screw hole than the one specified. If you screw them in another hole, it will contact and may cause damage to the mechanical parts inside the unit.

## Installation

### ■ Removing the hard rubber frame

- 1 Engage the catch pins on the removal tool and remove the two locks on the upper level.  
Upper the frame and pull it forward as shown in the figure.

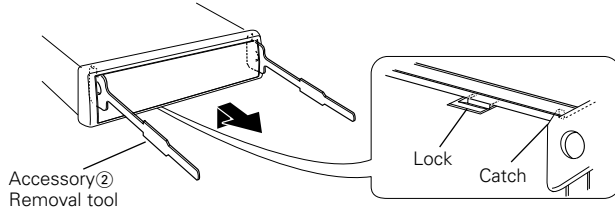

- 2 When the upper level is removed, remove the lower two locations.

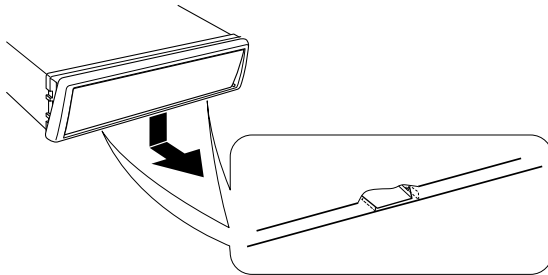

 The frame can be removed from the bottom side in the same manner.

### ■ Removing the Unit

- 1 Refer to the section <Removing the hard rubber frame> and then remove the hard rubber frame.
- 2 Remove the screw (M4x8) on the back panel.
- 3 Insert the two removal tools deeply into the slots on each side, as shown.

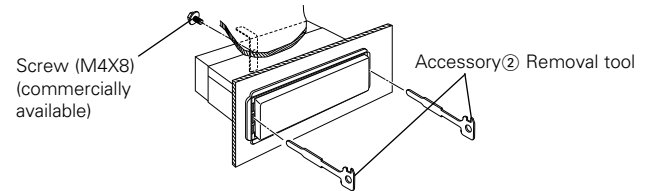

- 4 Lower the removal tool toward the bottom, and pull out the unit halfway while pressing towards the inside.

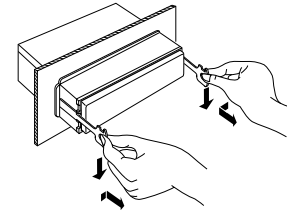

 Be careful to avoid injury from the catch pins on the removal tool.

- 5 Pull the unit all the way out with your hands, being careful not to drop it.

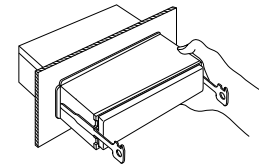

## Troubleshooting Guide

**What might seem to be a malfunction in your unit may just be the result of slight misoperation or miswiring. Before calling service, first check the following table for possible problems.**

### General

#### ? The power does not turn ON.

- ✓ The fuse has blown.
  - ☞ After checking for short circuits in the wires, replace the fuse with one with the same rating.

#### ? There's a source you can't switch.

- ✓ There's no media inserted.
  - ☞ Set the media you want to listen to. If there's no media in this unit, you can't switch to each source.
- ✓ The Disc changer isn't connected.
  - ☞ Connect the Disc changer. If the Disc changer isn't connected to it's input terminal, You can't switch to an external disc source.

#### ? The memory is erased when the ignition is turned OFF.

- ✓ The ignition and battery wire are incorrectly connected.
  - ☞ Connect the wire correctly, referring to the section on <Connecting Wires to Terminals>.

#### ? The TEL mute function does not work.

- ✓ The TEL mute wire is not connected properly.
  - ☞ Connect the wire correctly, referring to the section on <Connecting Wires to Terminals>.

#### ? The TEL mute function turns ON even though the TEL mute wire is not connected.

- ✓ The TEL mute wire is touching a metal part of the car.
  - ☞ Pull the TEL mute wire away from the metal part of the car.

#### ? Even if Loudness is turned ON, high-pitched tone isn't compensated for.

- ✓ Tuner source is selected.
  - ☞ High-pitched tone isn't compensated for when in Tuner source.

#### ? No sound can be heard, or the volume is low.

- ✓ The fader or balance settings are set all the way to one side.
  - ☞ Center the fader and balance settings.
- ✓ The input/output wires or wiring harness are connected incorrectly.
  - ☞ Reconnect the input/output wires or the wiring harness correctly. See the section on <Connecting Wires to Terminals>.
- ✓ The cassette tape is bad.
  - ☞ Try playing another cassette tape. If works fine, the first tape was bad.
- ✓ The values of Volume offset are low.
  - ☞ Turn up the Volume offset, referring to the section on <Audio control> (page 6).

#### ? The sound quality is poor or distorted.

- ✓ One of the speaker wires is being pinched by a screw in the car.
  - ☞ Check the speaker wiring.
- ✓ The tape head is dirty.
  - ☞ Clean the tape head.
- ✓ The speakers are not wired correctly.
  - ☞ Reconnect the speaker wires so that each output terminal is connected to a different speaker.

#### ? Even though Synchronize Clock is ON, the clock can't be adjusted.

- ✓ The received RDS station isn't sending time data.
  - ☞ Receive another RDS station.

### Tuner source

#### ? Radio reception is poor.

- ✓ The car antenna is not extended.
  - ☞ Pull the antenna out all the way.
- ✓ The antenna control wire is not connected.
  - ☞ Connect the wire correctly, referring to the section on <Connecting Wires to Terminals>.

## Troubleshooting Guide

### Cassette tape source

#### ? Can't remove tape.

- ✓ The cause is that more than 10 minutes has elapsed since the vehicle ACC switch was turned OFF.
  - ☞ The tape can only be removed within 10 minutes of the ACC switch being turned OFF. If more than 10 minutes has elapsed, turn the ACC switch ON again and press the Eject button.

#### ? The DPSS and Music Repeat don't operate correctly.

- ✓ The space between the songs on the tape can't be recognized because it's too short.
  - ☞ Have at least 4 seconds between songs.
- ✓ The space between songs can't be recognized because there's too much noise between songs.
  - ☞ Reduce the noise between songs.

#### ? The blank skip doesn't work.

- ✓ Because noise is too loud, the non-recorded part can't be recognized.
  - ☞ Reduce the noise between songs.

#### ? Blank Skip functions at places that are recorded.

- ✓ Because the recording level is low, it's recognized as not recorded.
  - ☞ Turn Blank Skip OFF.

#### ? <Music repeat> (page 16) is cancelled arbitrarily.

- ✓ The power was turned OFF or a source selection or other operation was performed.
  - ☞ Music repeat is cancelled when the power is turned OFF or a source selection or other operation is performed.

### Disc source

#### ? "AUX1" is displayed without achieving External disc control mode.

- ✓ Unsupported disc changer is connected.
  - ☞ Use the disc changer mentioned in the IMPORTANT INFORMATION of the section on <Safety precautions> (page 3).

#### ? The specified disc does not play, but another one plays instead.

- ✓ The specified CD is quite dirty.
  - ☞ Clean the CD.
- ✓ The disc is loaded in a different slot from that specified.
  - ☞ Eject the disc magazine and check the number for the specified disc.
- ✓ The disc is severely scratched.
  - ☞ Try another disc instead.

### If the following situations, consult your nearest service center:

Even though the disc changer is connected, the Disc Changer source is not ON, with "AUX1" showing in the display during the Changer Mode.



## The messages shown below display your systems condition.

EJECT:	No disc magazine has been loaded in the changer. The disc magazine is not completely loaded. ✦ Load the disc magazine properly. No CD in the unit. ✦ Insert the CD.
NO DISC:	No disc has been loaded in the disc magazine. ✦ Load a disc into the disc magazine.
TOC ER:	No disc has been loaded in the disc magazine. ✦ Load a disc into the disc magazine. The CD is quite dirty. The CD is upside-down. The CD is scratched a lot. ✦ Clean the CD and load it correctly.
E-05:	The CD is upside-down. ✦ Load the CD correctly.
BLANK:	Nothing has been recorded on the MD.
NO TRACK:	No tracks are recorded on the MD, although it has a title.
E-15:	Media was played that doesn't have data recorded that the unit can play. ✦ Use media that has data recorded that the unit can play.
NO PANEL:	The faceplate of the slave unit being connected to this unit has been removed. ✦ Replace it.
E-77:	The unit is malfunctioning for some reason. ✦ Press the reset button on the unit. If the "E-77" code does not disappear, consult your nearest service center.

MECHA ER:	Something is wrong with the disc magazine. Or the unit is malfunctioning for some reason. ✦ Check the disc magazine. And then press the reset button on the unit. If the "MECHA ER" code does not disappear, consult your nearest service center.
HOLD ER:	The protective circuit in the unit activates when the temperature inside the automatic disc changer exceeds 60°C (140°F), stopping all operation. ✦ Cool down the unit by opening the windows or turning on the air conditioner. As the temperature falls below 60°C (140°F), the disc will start playing again.
NO NAME:	Attempted to display DNPS during the CD play having no disc names preset.
WAITING:	Radio text data is being received.
LOAD:	Discs are being exchanged in the Disc changer.
IN (Blink):	The tape player section is not operating properly. ✦ Reinsert the Tape. If the tape cannot be ejected or the display continues to flash even when the tape has been properly reinserted, please switch off the power and consult your nearest service center.

## Specifications

### Specifications subject to change without notice.

#### FM tuner section

Frequency range (50 kHz space) .....	87.5 MHz – 108.0 MHz
Usable sensitivity (S/N = 26dB) .....	0.7 $\mu$ V /75 $\Omega$
Quieting Sensitivity (S/N = 46dB) .....	1.6 $\mu$ V /75 $\Omega$
Frequency response ( $\pm$ 3.0 dB) .....	30 Hz – 15 kHz
Signal to Noise ratio (MONO) .....	65 dB
Selectivity (DIN) ( $\pm$ 400 kHz) .....	$\geq$ 80 dB
Stereo separation (1 kHz) .....	35 dB

#### MW tuner section

Frequency range (9 kHz space) .....	531 kHz – 1611 kHz
Usable sensitivity (S/N = 20dB) .....	25 $\mu$ V

#### LW tuner section

Frequency range .....	153 kHz – 281 kHz
Usable sensitivity (S/N = 20dB) .....	45 $\mu$ V

#### Cassette player section

Tape Speed .....	4.76 cm/sec.
Wow & Flutter (WRMS) .....	0.08 %
Frequency response ( $\pm$ 3.0 dB) (70 $\mu$ s) .....	30 Hz – 20 kHz
Separation (1 kHz) .....	43 dB
Signal to Noise ratio	
Dolby NR OFF .....	57 dB
Dolby B NR ON .....	65 dB

#### Audio section

Maximum output power .....	47 W x 4
Output power (DIN 45324, +B=14.4V) .....	28 W x 4
Tone action	
Bass : .....	100 Hz $\pm$ 10 dB
Middle : .....	1 kHz $\pm$ 10 dB
Treble : .....	10 kHz $\pm$ 10 dB
Preout level / Load (during disc play) .....	2000 mV / 10 k $\Omega$
Preout impedance .....	$\leq$ 600 $\Omega$

#### General

Operating voltage (11 – 16V allowable) .....	14.4 V
Current consumption .....	10 A
Installation Size (W x H x D) .....	182 x 53 x 155 mm
Weight .....	1.2 kg



KENWOOD

## Free Manuals Download Website

<http://myh66.com>

<http://usermanuals.us>

<http://www.somanuals.com>

<http://www.4manuals.cc>

<http://www.manual-lib.com>

<http://www.404manual.com>

<http://www.luxmanual.com>

<http://aubethermostatmanual.com>

Golf course search by state

<http://golfingnear.com>

Email search by domain

<http://emailbydomain.com>

Auto manuals search

<http://auto.somanuals.com>

TV manuals search

<http://tv.somanuals.com>