

# KENWOOD

## KAC-718

---

MONO POWER AMPLIFIER

### **INSTRUCTION MANUAL**

KENWOOD CORPORATION

# Safety precautions

## ▲WARNING

### To prevent injury or fire, take the following precautions:

- When extending the ignition, battery, or ground wires, make sure to use automotive-grade wires or other wires with a 3mm<sup>2</sup> (AWG12) or more to prevent wire deterioration and damage to the wire coating.
- To prevent a short circuit, never put or leave any metallic objects (such as coins or metal tools) inside the unit.
- If the unit starts to emit smoke or strange smells, turn off the power immediately and consult your Kenwood dealer.
- Do not touch the unit during use because the surface of the unit becomes hot and may cause burns if touched.

## ▲CAUTION

### To prevent damage to the machine, take the following precautions:

- Be sure the unit is connected to a 12V DC power supply with a negative ground connection.
- Do not open the top or bottom covers of the unit.
- Do not install the unit in a spot exposed to direct sunlight or excessive heat or humidity. Also avoid places with too much dust or the possibility of water splashing.
- When replacing a fuse, only use a new one with the prescribed rating. Using a fuse with the wrong rating may cause your unit to malfunction.
- To prevent a short circuit when replacing a fuse, first disconnect the wiring harness.

## NOTE

- If you experience problems during installation, consult your Kenwood dealer.
- If the unit does not seem to be working right, consult your Kenwood dealer.





## Cleaning the unit

If the front panel gets dirty, turn off the power and wipe the panel with a dry silicon cloth or soft cloth.

## ▲CAUTION

Do not wipe the panel with a hard cloth or a cloth dampened by volatile solvents such as paint thinner and alcohol. They can scratch the surface of the panel and/or cause the indicator letters to peel off.

## Accessories

Part name	External View	Number of Items
Round terminal (Large)		1
Round terminal (Medium)		2
Round terminal (Small)		1
Terminal cover (Power terminal)		1
Self-tapping screws (ø4 × 16 mm)		4

## Installation procedure

1. Remove the ignition key and disconnect the negative  $\ominus$  terminal of the battery to prevent short circuits.
2. Set the unit according to the intended usage.
3. Connect the input and output cables of the units.
4. Connect the speaker cables.
5. Connect the power cable, power control cable and grounding cable following this order.
6. Install the unit in the car.
7. Connect the negative  $\ominus$  terminal of the battery.

### ▲CAUTION

- Be sure to turn the power off before changing the setting of any switch.
- If the fuse blows, check cables for shorts, then replace the fuse with one of the same rating.
- Check that no unconnected cables or connectors are touching the car body. Do not remove caps from unconnected cables or connectors to prevent short circuits.
- Connect the speaker cables to appropriate speaker connectors separately. Sharing the negative cable of the speaker or grounding speaker cables to the metal body of the car can cause this unit to fail.
- After installation, check that the brake lamps, wipers, and wipers work properly.

## Installation

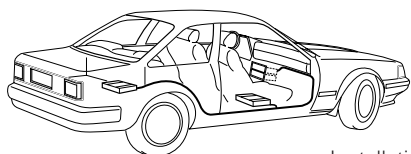

Self-tapping screw  
( $\varnothing 4 \times 16$  mm)

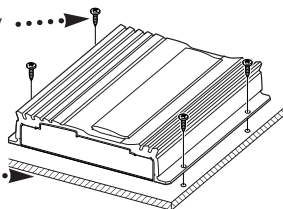

Installation board, etc. ....  
(thickness : 15 mm or more)

Since the power amplifier has no parts which require operation, it can be installed at a position away from the driver's seat without any hindrances.

As generally accepted positions for its installation, places such as inside the trunk, etc. can be considered.

### ▲CAUTION

- Do not install the unit under the carpet. Otherwise heat build-up occurs and the unit may be damaged.
- Install this unit in a location which allows heat to easily dissipate. Once installed, do not place any object on top of the unit.
- The surface temperature of the amplifier will become hot during use. Install the amplifier in a place where people, resins, and other substances that are sensitive to heat will not come into contact with it.
- When making a hole under a seat, inside the trunk, or somewhere else in the vehicle, check that there is nothing hazardous on the opposite side such as a gasoline tank, brake pipe, or wiring harness, and be careful not to cause scratches or other damage.
- Do not install near the dashboard, rear tray, or air bag safety parts.
- The installation to the vehicle should securely fasten the unit to a place in which it will not obstruct driving. If the unit comes off due to a shock and hits a person or safety part, it may cause injury or an accident.
- After installing the unit, check to make sure that electrical equipment such as the brake lamps, turn signal lamps and windshield wipers operate normally.

# Controls

Operations of the following control and switches are required in accordance with the center unit and speakers connected with this unit.

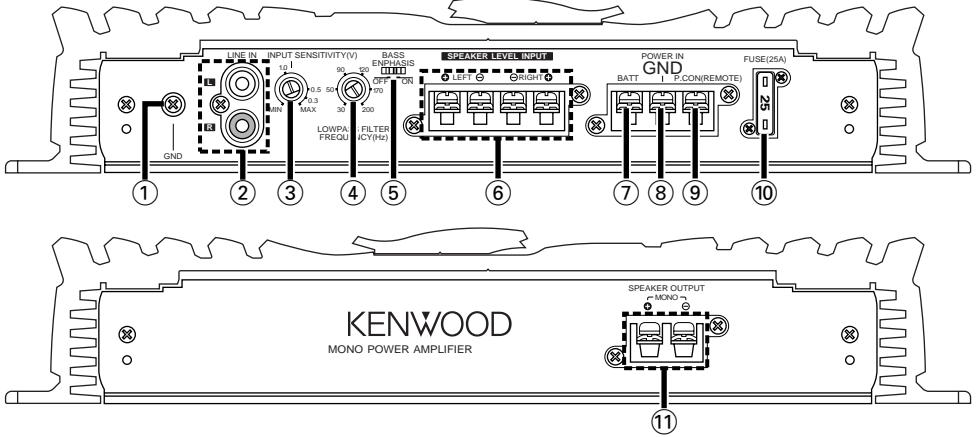

① **RCA cable ground lead terminal**

② **LINE IN terminal**

③ **INPUT SENSITIVITY control**

Set this control according to the pre-output level of the center unit connected with this unit, or to the maximum power output of the genuine-accessory car stereo.

Use the diagram on the right as a guide.

### NOTE

For the pre-output level or the maximum power output, refer to the "Specifications" in the instruction manual of the center unit.

④ **LOW PASS FILTER FREQUENCY control**

This control adjusts the frequency band output from this unit.

⑤ **BASS EMPHASIS switch**

This switch allows to emphasize the output from this unit.

⑥ **Speaker level input terminals**

⑦ **Battery terminal**

⑧ **Ground terminal**

⑨ **Power control (REMOTE) terminal**

⑩ **FUSE (25 A × 1)**

⑪ **Speaker output terminals**

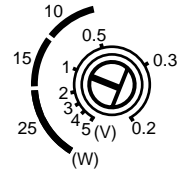

# Protection function

This unit is equipped with a protection function for protecting this unit and your speakers from various accidents or problems that can occur.

When the protection function is triggered, the Power indicator goes off and the amplifier stops operating.

## ■ Power indicator:

When the power is turned on, the Power indicator lights.

If the Power indicator does not light when the power is turned on, the protection function may be activated. Check whether there is any indication of trouble.

## ■ The protection function activates in the following situations:

- When a speaker cable may be short-circuited.
- When a speaker output contacts ground.
- When the unit malfunctions and a DC signal is sent to the speaker output.
- When the temperature of internal parts exceeds 120°C (248°F).
- When a ground cable of the center unit (cassette receiver, CD receiver, etc.) or this unit is not connected to a metal part serving as an electrical ground passing electricity to the battery's negative ⊖ terminal.

Power indicator



# Connection

## ■ Speakers cable connection

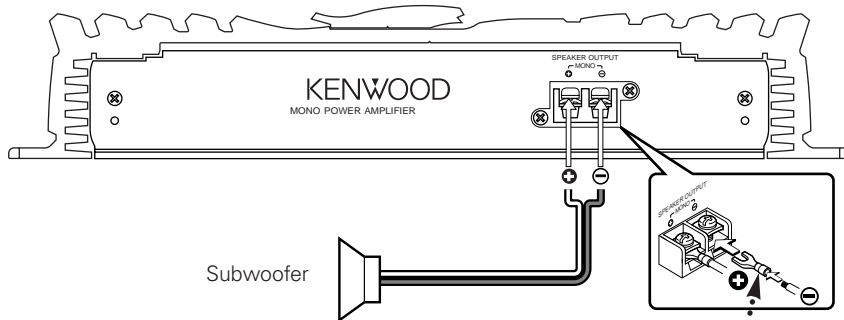

Lead terminal  
(Commercially available parts)

## ■ Speaker Selection

- The rated input power of the speakers that are going to be connected should be greater than the maximum output power (in Watts) of the amplifier. Use of speakers having input power ratings that are less than the output power of the amplifier will cause smoke to be emitted as well as damage.
- Use speakers that have an impedance of 2Ω or greater. When more than one set of speakers are going to be used, calculate the combined impedance of the speakers and then connect suitable speakers to the amplifier.

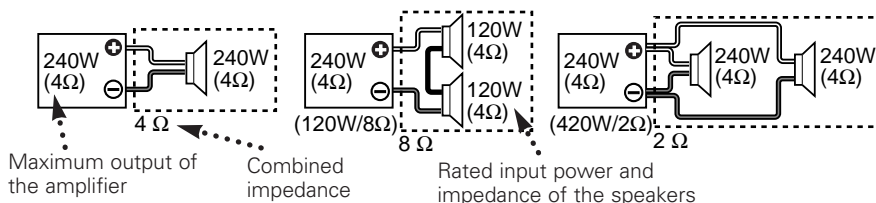

# Connection

## RCA cable connection

### CAUTION

Do not connect cables and leads to both RCA cable input jacks and the speaker input terminals simultaneously, for this may cause malfunction or damage.

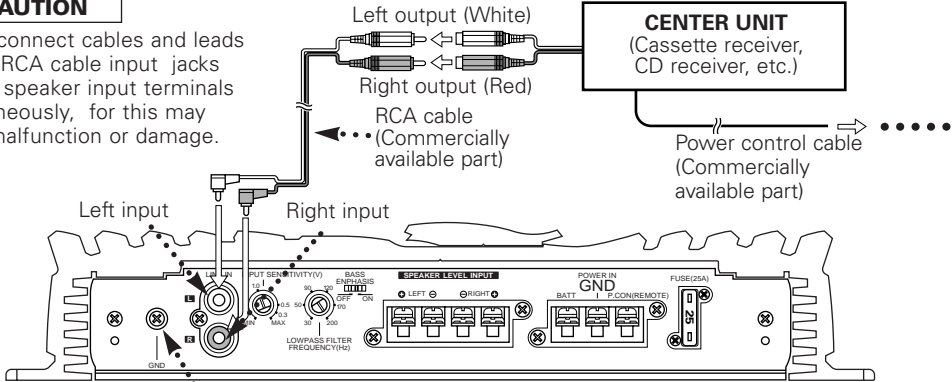

### RCA cable ground terminal

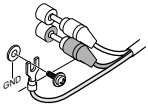

When using an RCA cable with a ground lead attached, connect the ground lead to this terminal.

### CAUTION

Do not use this terminal for power source grounding. This unit will be damaged if the power source grounding wire is connected to this terminal.

## Speaker level input connection

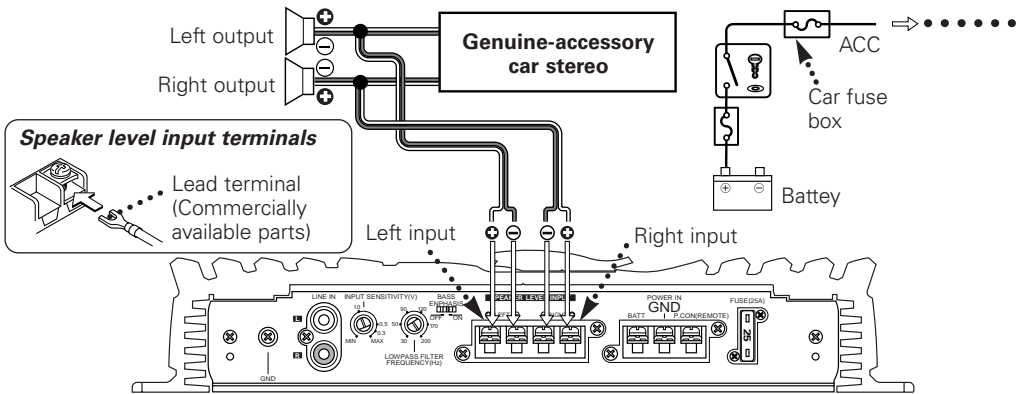

### CAUTION

- The genuine-accessory car stereo shall have a maximum power output of no more than 25 W.
- Do not connect the speaker output leads from a power amplifier (Optional) to the speaker input terminals of this unit, for this may cause malfunction or damage.
- Do not connect cables and leads to both RCA cable input jacks and the speaker input terminals simultaneously, for this may cause malfunction or damage.
- Connect the power control lead to a power supply which can be turned ON/OFF by the ignition key switch (ACC line).

With this connection, shock noise may be generated when the power of the genuine-accessory car stereo is switched ON/OFF.

## ■ Power wire connection

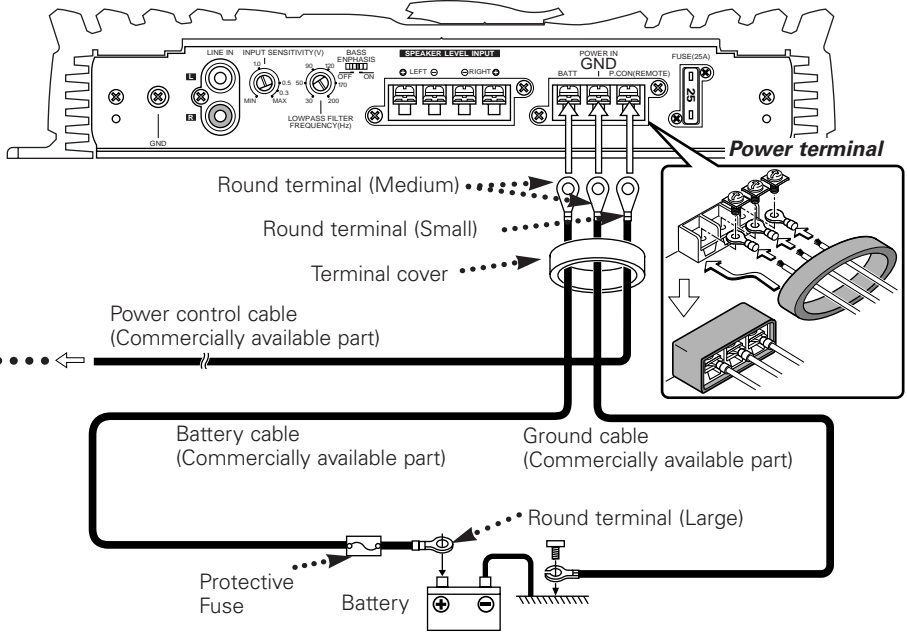

### ▲WARNING

To prevent fire caused by a short in the wiring, connect a fusible link or breaker nearby the battery's positive terminal.

### Wiring

- If a buzzing noise is heard from the speakers when the engine is running, connect a line noise filter (optional) to each of the battery wire.
- Do not allow the cord to directly contact the edge of the iron plate by using Grommets.
- Connect the ground wire to a metal part of the car chassis that acts as an electrical ground passing electricity to the battery's negative  $\ominus$  terminal. Do not turn the power on if the ground wire is not connected.
- Be sure to attach a protective fuse into the battery wire close to the battery. Use a protective fuse having a capacity that is about 10 A higher than the maximum current drawn by the amplifier.
- Use vehicle-type (fire-resistant) power supply wiring wire for the battery wire and the ground wire. The current capacity of the power supply wiring wire should be about 10 A higher than that of the protective fuse capacity (which means about 20 A higher than the maximum current drawn by the amplifier).
- When more than one power amplifier are going to be used, use a power supply wiring wire and protective fuse of greater current-handling capacity than the total maximum current drawn by each amplifier.

### Power terminal

Connect to their respective terminals the power control wire, power supply wire, and ground wire, all of which pass through the associated terminal cover. Once the connections are complete, place the cover on the terminal section.

### Example: One Power Amplifier Is Used

<b>Maximum Current Drawn</b>	15 A
<b>Protective Fuse</b>	30 A × 1 [15 A × 2]
<b>Cross-sectional Area of Wiring Wire (AWG)</b>	3 mm <sup>2</sup> (AWG 12) or greater × 1

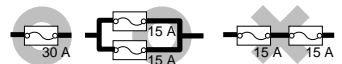

# Troubleshooting Guide

**What might appear to be a malfunction in your unit may just be the result of slight misoperation or miswiring. Before calling service, first check the following table for possible problems.**

<b>PROBLEM</b>	<b>POSSIBLE CAUSE</b>	<b>SOLUTION</b>
<b>No sound. (No sound from one side.)</b>	<ul style="list-style-type: none"> <li>• Input (or output) cables are disconnected.</li> <li>• Protection circuit may be activated.</li> <li>• The fuse may be blown because the volume was too high.</li> </ul>	<ul style="list-style-type: none"> <li>• Connect the input (or output) cables.</li> <li>• Check connections by referring to "Protection function".</li> <li>• Replace the fuse with a new fuse and use a lower volume.</li> </ul>
<b>The output level is too small (or too large).</b>	The input sensitivity adjusting control is not set to the correct position.	Adjust the control correctly referring to "Controls".
<b>The sound quality is bad. (The sound is distorted.)</b>	<ul style="list-style-type: none"> <li>• The speakers cable are connected with wrong <math>\oplus / \ominus</math> polarity.</li> <li>• A speaker cable is pinched by a screw in the car body.</li> <li>• The switches may be set improperly.</li> </ul>	<ul style="list-style-type: none"> <li>• Connect them properly checking the <math>\oplus / \ominus</math> of the terminals and cables well.</li> <li>• Connect the speaker cable again so that it is not pinched by anything.</li> <li>• Set switches properly by referring to "Controls".</li> </ul>

## Specifications

**Specifications subject to change without notice.**

### Audio Section

Max Power Output (4 $\Omega$ ) .....	240 W $\times$ 1 (at 100 Hz)
Rated Power Output (4 $\Omega$ ) .....	120 W $\times$ 1 (DIN45324, +B=14.4V, at 100 Hz)
(2 $\Omega$ ) .....	160 W $\times$ 1 (0.8 % THD at 100 Hz)
Signal to Noise Ratio .....	100 dB
Sensitivity (MAX) .....	0.15 V (rated output)
(MIN) .....	4.0 V (rated output)
Input Impedance .....	10 k $\Omega$
Damping Factor .....	More than 100
Low Pass Filter Frequency (12 dB / oct.) .....	30 ~ 200 Hz (Variable)

### General

Operating Voltage .....	14.4 V (11 ~ 16 V allowable)
Current Consumption (1 kHz, 10% THD, 4 $\Omega$ ) .....	15 A
Dimensions (W $\times$ H $\times$ D) .....	290 $\times$ 56 $\times$ 170 mm
Weight .....	3.0 kg



## Free Manuals Download Website

<http://myh66.com>

<http://usermanuals.us>

<http://www.somanuals.com>

<http://www.4manuals.cc>

<http://www.manual-lib.com>

<http://www.404manual.com>

<http://www.luxmanual.com>

<http://aubethermostatmanual.com>

Golf course search by state

<http://golfingnear.com>

Email search by domain

<http://emailbydomain.com>

Auto manuals search

<http://auto.somanuals.com>

TV manuals search

<http://tv.somanuals.com>