

KENWOOD

KAC-8151D KAC-8101D

MONO POWER AMPLIFIER ► page 2-11

INSTRUCTION MANUAL

AMPLIFICATEUR DE PUISSANCE MONAURAL ► page 12-21

MODE D'EMPLOI

AMPLIFICADOR DE POTENCIA MONOFONICO ► página 22-31

MANUAL DE INSTRUCCIONES

KENWOOD CORPORATION



**Take the time to read through this instruction manual.
Familiarity with installation and operation procedures will help
you obtain the best performance from your new power amplifier.**

For your records

Record the serial number, found on the back of the unit, in the spaces designated on the warranty card, and in the space provided below.

Refer to the model and serial numbers whenever you call upon your KENWOOD dealer for information or service on the product.

Model KAC-8151D/8101D Serial number _____

© PRINTED IN CHINA B64-2577-00/00 (KV/EV)

Safety precautions

▲WARNING

To prevent injury or fire, take the following precautions:

- When extending the ignition, battery, or ground wires, make sure to use automotive-grade wires or other wires with a 5 mm² (AWG 10) or more to prevent wire deterioration and damage to the wire coating.
- To prevent a short circuit, never put or leave any metallic objects (such as coins or metal tools) inside the unit.
- If the unit starts to emit smoke or strange smells, turn off the power immediately and consult your Kenwood dealer.
- Do not touch the unit during use because the surface of the unit becomes hot and may cause burns if touched.

▲CAUTION

To prevent damage to the machine, take the following precautions:

- Be sure the unit is connected to a 12V DC power supply with a negative ground connection.
- Do not open the top or bottom covers of the unit.
- Do not install the unit in a spot exposed to direct sunlight or excessive heat or humidity. Also avoid places with too much dust or the possibility of water splashing.
- When replacing a fuse, only use a new one with the prescribed rating. Using a fuse with the wrong rating may cause your unit to malfunction.
- To prevent a short circuit when replacing a fuse, first disconnect the wiring harness.

NOTE

- If you experience problems during installation, consult your Kenwood dealer.
- If the unit does not seem to be working right, consult your Kenwood dealer.

FCC WARNING

This equipment may generate or use radio frequency energy. Changes or modifications to this equipment may cause harmful interference unless the modifications are expressly approved in the instruction manual. The user could lose the authority to operate this equipment if an unauthorized change or modification is made.

Cleaning the unit

If the front panel gets dirty, turn off the power and wipe the panel with a dry silicon cloth or soft cloth.

▲CAUTION

Do not wipe the panel with a hard cloth or a cloth dampened by volatile solvents such as paint thinner and alcohol. They can scratch the surface of the panel and/or cause the indicator letters to peel off.



To prevent battery rise

When the unit is used in the ACC ON position without turning the engine ON, it depletes the battery. Use it after starting the engine.









Protection function

There is a Protection function installed in the unit to protect the unit and speakers from various problems. When Protection operates, the indicator informs you of the condition. (Refer to page 5)

Accessories

Part name	External View	Number of Items
Self-tapping screws (ø4 × 16 mm)		4
Terminal cover (Power terminal)		1
Speaker level input cable		1

(KAC-8151D only)

Part name	External View	Number of Items
Remote cable		1
Remote controller		1
Knob		1
Dressing plate		1
Nut		1
Washer		1
Self-tapping screws (ø3 × 12 mm)		2
Double-side tape		1

Installation

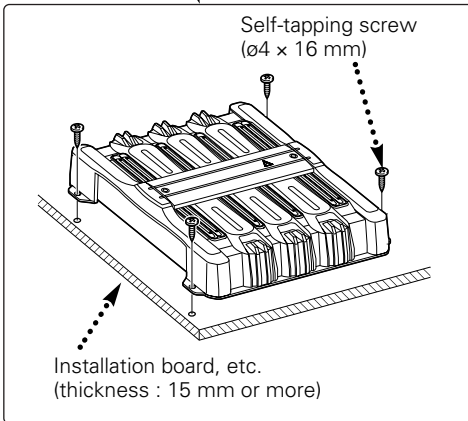
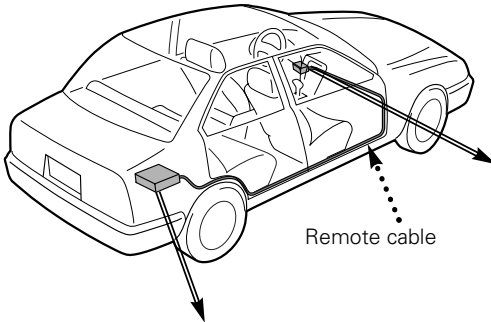

Remote controller (KAC-8151D only)

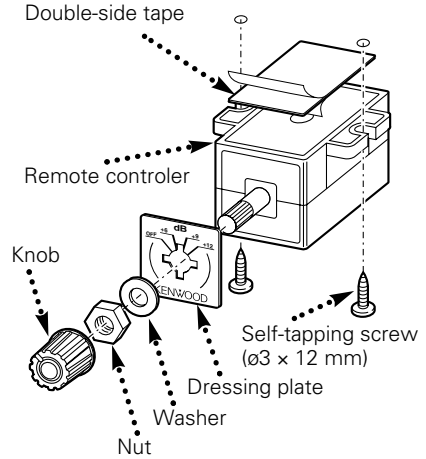

NOTE

Mount the Dressing plate according to the mount angle of the Remote Controller.

Fully rotate the knob counterclockwise (CCW), and adjust the marking of the knob to the "OFF" position of the Dressing plate.

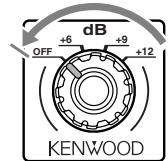

CAUTION

- Do not install in the below locations;
(Unstable location, In a location that interferes with driving, In a location that gets wet, In a dusty location, In a place that gets hot, In a place that gets direct sunlight, In a location that gets hit by hot air)
- Do not install the unit under the carpet. Otherwise heat build-up occurs and the unit may be damaged.
- Install this unit in a location which allows heat to easily dissipate.
Once installed, do not place any object on top of the unit.
- The surface temperature of the amplifier will become hot during use. Install the amplifier in a place where people, resins, and other substances that are sensitive to heat will not come into contact with it.
- When making a hole under a seat, inside the trunk, or somewhere else in the vehicle, check that there is nothing hazardous on the opposite side such as a gasoline tank, brake pipe, or wiring harness, and be careful not to cause scratches or other damage.
- Do not install near the dashboard, rear tray, or air bag safety parts.
- The installation to the vehicle should securely fasten the unit to a place in which it will not obstruct driving. If the unit comes off due to a shock and hits a person or safety part, it may cause injury or an accident.
- After installing the unit, check to make sure that electrical equipment such as the brake lamps, turn signal lamps and windshield wipers operate normally.

Controls / Indicator

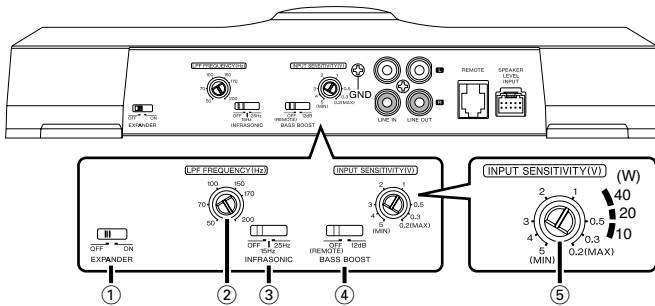

① **EXPANDER switch**

When this switch is turned ON the dynamic range is increased.

② **LPF (Low-Pass Filter) FREQUENCY control**

This control adjusts the frequency band output from this unit.

③ **INFRASONIC switch**

Ultralow frequencies that cannot be reproduced even by a subwoofer speaker do not become sound but become unnecessary oscillations, which affect the sound by causing distortion, etc. Setting this switch to "15 Hz" or "25 Hz" cuts the frequencies below the respective frequency.

This improves the reproduction performance of the speakers by eliminating unnecessary oscillations which will not become sound.

④ **BASS BOOST switch**

Sets the boost level for bass control.

• **12dB position:**

BASS BOOST is +12 dB.

• **KAC-8101D: OFF position:**

BASS BOOST is OFF.

• **KAC-8151D: OFF(REMOTE) position:**

Can be set from the Remote Controller.

NOTE

If you have disconnected the Remote Controller, the BASS BOOST is turned OFF.

⑤ **INPUT SENSITIVITY control**

Set this control according to the pre-output level of the center unit connected with this unit, or to the maximum power output of the genuine-accessory car stereo. Use the diagram on the right as a guide.

NOTE

For the pre-output level or the maximum power output, refer to the "Specifications" in the instruction manual of the center unit.

⑥ **Remote controller control (KAC-8151D only)**

When the "BASS BOOST" switch is in the "OFF (REMOTE)" position, control the Bass Boost level from the Remote Controller.

• **OFF position:**

BASS BOOST is OFF.

• **+6/+9/+12 position:**

Boost the bass sound by +6 dB, +9 dB and +12 dB, respectively.

**Remote controller
(KAC-8151D only)**

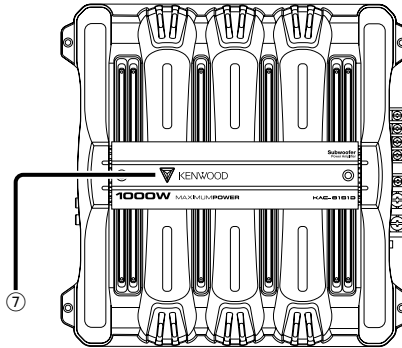
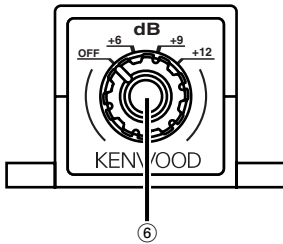

⑦ **Power indicator**

When the power is turned on, the Power indicator lights.
If the Power indicator does not light when the power is turned on, the protection function may be activated. Check whether there is any indication of trouble.

■ **The protection function is activated in the following situations:**

This unit is equipped with a protection function for protecting this unit and your speakers from various accidents or problems that can occur.
When the protection function is triggered, the Power indicator goes off and the amplifier stops operating.

- When a speaker wire may be short-circuited.
- When a speaker output contacts ground.
- When the unit malfunctions and a DC signal is sent to the speaker output.
- When the internal temperature is high and unit won't operate.
- When a ground wire of the center unit (cassette receiver, CD receiver, etc.) or this unit is not connected to a metal part serving as an electrical ground passing electricity to the battery's negative ⊖ terminal.

Connection

■ Terminal names

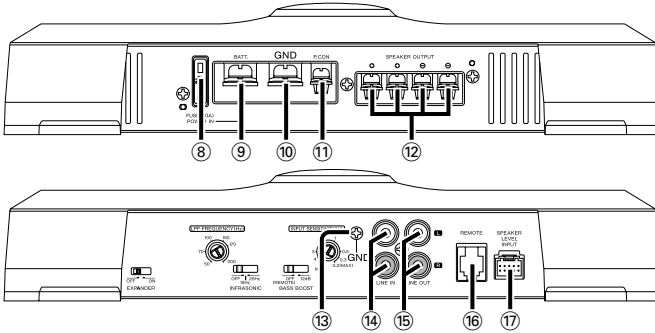

⑧ Fuse (40 A)

NOTE

If you can't find the specified capacity fuse at your store etc., consult your Kenwood dealer.

⑨ Battery terminal

⑩ Ground terminal

⑪ Power control terminal

Controls the unit ON/OFF.

NOTE

Controls the unit power. Be sure to connect it with all the systems.

⑫ Speaker output terminals

As this unit accepts speakers with a minimum impedance of 1 ohm, connect speakers with 1-ohm or higher impedance to these terminals.

⚠CAUTION

The rated input of the speakers should be no less than the maximum output of the amplifier. Otherwise malfunction may result.

⑬ RCA cable ground lead terminal

When using an RCA cable with a ground lead attached, connect the ground lead to this terminal.

⑭ LINE IN terminal

⑮ LINE OUT terminal

The signal that's input from the line input terminal is output.

⑯ REMOTE terminal (KAC-8151D only)

Connects the Remote cable.

NOTE

Use the Remote cable of the accessory.

⑰ Speaker level input terminals

NOTE

- The genuine-accessory car stereo shall have a maximum power output of no more than 40 W.
- Do not connect the speaker output leads from a power amplifier (Optional) to the speaker level input terminals of this unit, for this may cause malfunction or damage.
- Do not connect cables and leads to both RCA cable input jacks and the speaker level input terminals simultaneously, for this may cause malfunction or damage.
- Connect the power control lead to a power supply which can be turned ON/OFF by the ignition key switch (ACC line). With this connection, shock noise may be generated when the power of the genuine-accessory car stereo is switched ON/OFF.

■ Installation procedure

Since there are large variety of settings and connections possible according to applications, read the instruction manual well to select the proper setting and connection.

1. Remove the ignition key and disconnect the negative \ominus terminal of the battery to prevent short circuits.
2. Set the unit according to the intended usage.
3. Connect the input and output wires of the units.
4. Connect the speaker wires.
5. Connect the power wire, power control wire and grounding wire following this order.
6. Install the unit in the car.
7. Connect the negative \ominus terminal of the battery.

▲WARNING

To prevent fire caused by a short in the wiring, connect a fusible link or breaker nearby the battery's positive terminal.

▲CAUTION

- If sound is not output normally, immediately turn power off and check connections.
- Be sure to turn the power off before changing the setting of any switch.
- If the fuse blows, check wires for shorts, then replace the fuse with one of the same rating.
- Check that no unconnected wires or connectors are touching the car body. Do not remove caps from unconnected wires or connectors to prevent short circuits.
- Connect the speaker wires to appropriate speaker connectors separately. Sharing the negative wire of the speaker or grounding speaker wires to the metal body of the car can cause this unit to fail.
- After installation, check that the brake lamps, wipers, and wipers work properly.

■ Wiring

- Take the battery wire for this unit directly from the battery. If it's connected to the vehicle's wiring harness, it can cause blown fuses etc.
- If a buzzing noise is heard from the speakers when the engine is running, connect a line noise filter (optional) to each of the battery wire.
- Do not allow the wire to directly contact the edge of the iron plate by using Grommets.
- Connect the ground wire to a metal part of the car chassis that acts as an electrical ground passing electricity to the battery's negative \ominus terminal. Do not turn the power on if the ground wire is not connected.
- Be sure to install a protective fuse in the power cord near the battery. The protective fuse should be the same capacity as the unit's fuse capacity or somewhat larger.
- For the power cord and ground, use a vehicle type (fireproof) power wiring cord with a current capacity greater than the unit's fuse capacity. (Use a power wiring cord with a diameter of 5 mm² (AWG 10) or greater.)
- When more than one power amplifier are going to be used, use a power supply wiring wire and protective fuse of greater current-handling capacity than the total maximum current drawn by each amplifier.

■ Speaker Selection

- The rated input power of the speakers that are going to be connected should be greater than the maximum output power (in Watts) of the amplifier. Use of speakers having input power ratings that are less than the output power of the amplifier will cause smoke to be emitted as well as damage.
- Use speakers that have an impedance of 1Ω or greater. When more than one set of speakers are going to be used, calculate the combined impedance of the speakers and then connect suitable speakers to the amplifier.

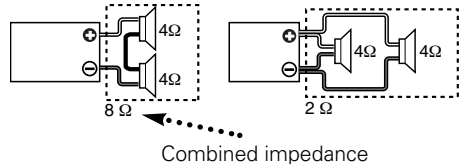

Connection

■ RCA cable or Speaker level input connection

(RCA cable Connections)

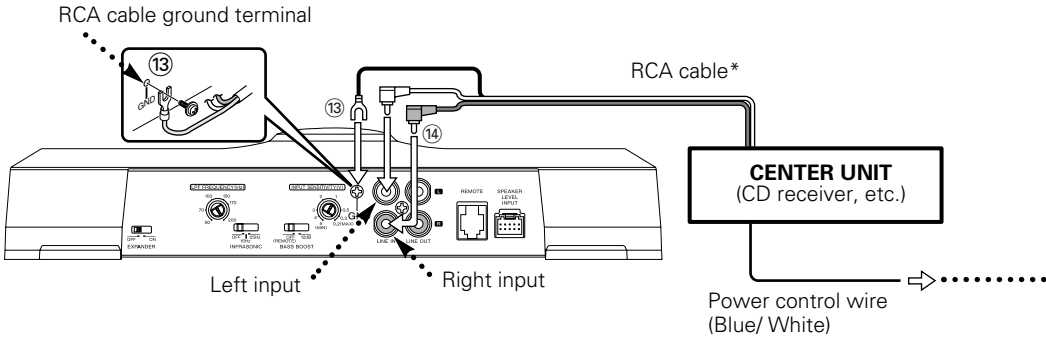

(Speaker level input Connections)

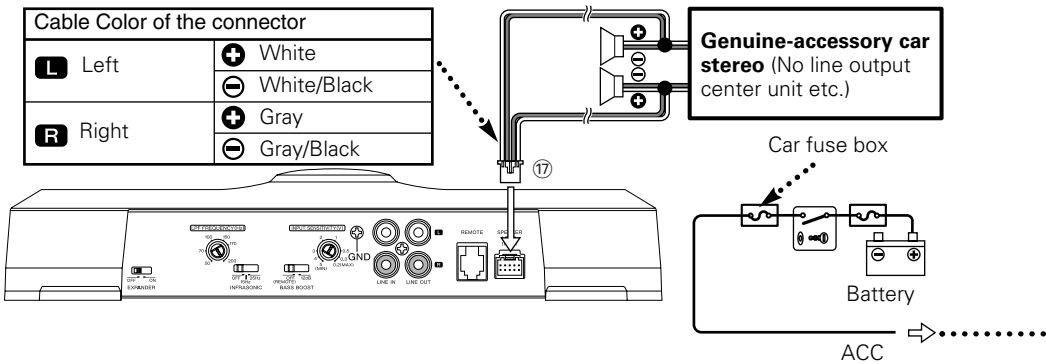

■ Remote cable connection (KAC-8151D only)

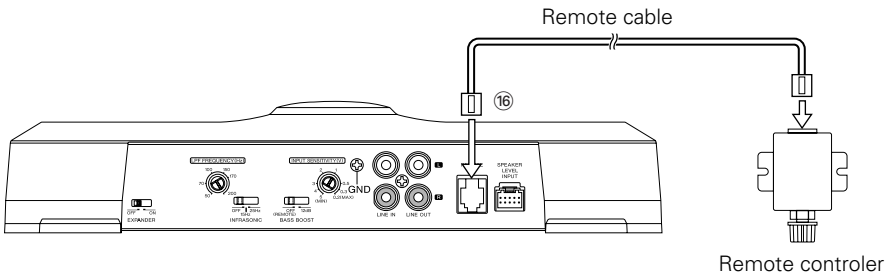

■ Speaker wire connection

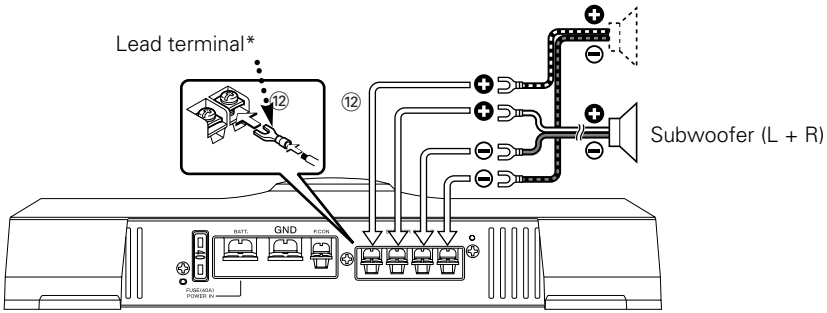

■ Power wire connection

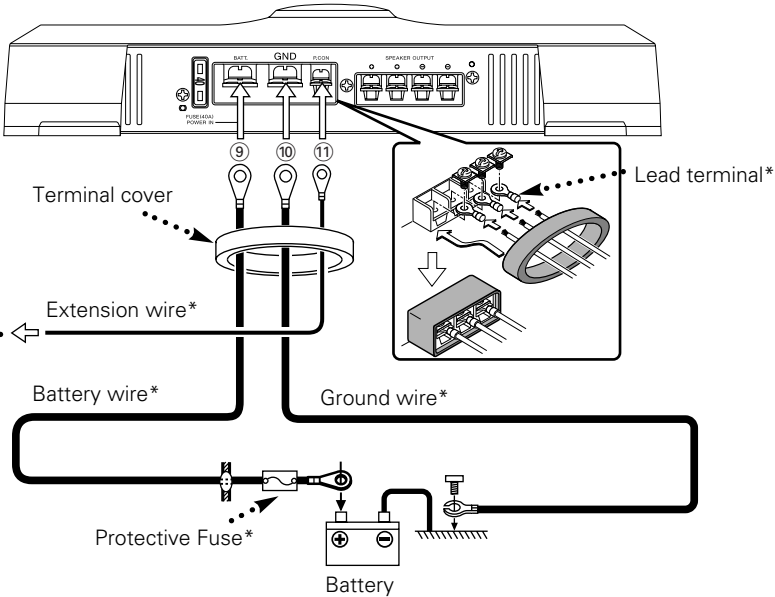

Troubleshooting Guide

What might appear to be a malfunction in your unit may just be the result of slight misoperation or miswiring. Before calling service, first check the following table for possible problems.

PROBLEM	POSSIBLE CAUSE	SOLUTION
No sound. (No sound from one side.) (Blown fuse.)	<ul style="list-style-type: none">• Input (or output) cables are disconnected.• Protection circuit may be activated.• Volume is too high.• The speaker cord is shorted.	<ul style="list-style-type: none">• Connect the input (or output) cables.• Check connections by referring to "Indicator".• Replace the fuse and use lower volume.• After check the speaker cord and fixing the cause of the short, replace the fuse.
The output level is too small (or too large).	The input sensitivity adjusting control is not set to the correct position.	Adjust the control correctly referring to "Controls".
The sound quality is bad. (The sound is distorted.)	<ul style="list-style-type: none">• The speakers wire are connected with wrong \oplus / \ominus polarity.• A speaker wire is pinched by a screw in the car body.• The switches may be set improperly.	<ul style="list-style-type: none">• Connect them properly checking the \oplus / \ominus of the terminals and wires well.• Connect the speaker wire again so that it is not pinched by anything.• Set switches properly by referring to "Controls".
The Remote Controller does not function.	<ul style="list-style-type: none">• The "BASS BOOST" switch is in the incorrect position.• The Remote Cable is disconnected.	<ul style="list-style-type: none">• Set the "BASS BOOST" switch to the "OFF (REMOTE)" position.• Connect the Remote Cable securely and correctly.

Free Manuals Download Website

<http://myh66.com>

<http://usermanuals.us>

<http://www.somanuals.com>

<http://www.4manuals.cc>

<http://www.manual-lib.com>

<http://www.404manual.com>

<http://www.luxmanual.com>

<http://aubethermostatmanual.com>

Golf course search by state

<http://golfingnear.com>

Email search by domain

<http://emailbydomain.com>

Auto manuals search

<http://auto.somanuals.com>

TV manuals search

<http://tv.somanuals.com>