

KENWOOD

STEREO INTEGRATED AMPLIFIER

KAF-3030R

KAF-1030

INSTRUCTION MANUAL

KENWOOD CORPORATION

B60-4527-08 (EN)

Before applying power

 **Caution: Read this page carefully to ensure safe operation.**





KAF-3030R/1030 (En)

Units are designed for operation as follows.

2 Europe and UK..... AC 230 V only

Safety precautions

WARNING : TO PREVENT FIRE OR ELECTRIC SHOCK, DO NOT EXPOSE THIS APPLIANCE TO RAIN OR MOISTURE.

	CAUTION RISK OF ELECTRIC SHOCK DO NOT OPEN		CAUTION: TO REDUCE THE RISK OF ELECTRIC SHOCK, DO NOT REMOVE COVER (OR BACK). NO USER-SERVICEABLE PARTS INSIDE, REFER SERVICING TO QUALIFIED SERVICE PERSONNEL.
	THE LIGHTNING FLASH WITH ARROWHEAD SYMBOL, WITHIN AN EQUILATERAL TRIANGLE, IS INTENDED TO ALERT THE USER TO THE PRESENCE OF UNINSULATED "DANGEROUS VOLTAGE" WITHIN THE PRODUCT'S ENCLOSURE THAT MAY BE OF SUFFICIENT MAGNITUDE TO CONSTITUTE A RISK OF ELECTRIC SHOCK TO PERSONS.		
	THE EXCLAMATION POINT WITHIN AN EQUILATERAL TRIANGLE IS INTENDED TO ALERT THE USER TO THE PRESENCE OF IMPORTANT OPERATING AND MAINTENANCE (SERVICING) INSTRUCTIONS IN THE LITERATURE ACCOMPANYING THE APPLIANCE.		

Unpacking

Unpack the unit carefully and make sure that all accessories are put aside so they will not be lost.

Examine the unit for any possibility of shipping damage. If your unit is damaged or fails to operate, notify your dealer immediately. If your unit was shipped to you directly, notify the shipping company without delay. Only the consignee (the person or company receiving the unit) can file a claim against the carrier for shipping damage.

We recommend that you retain the original carton and packing materials for use should you transport or ship the unit in the future.

Special features

Adv. DA / CD DIRECT (KAF-3030R only)



The Advanced Digital Audio/CD input combined with a "direct" function. This feature allows this amplifier to achieve the highest quality of performance when used with the latest generation of CD (HDCD/SACD) Players or DVD (96/192 kHz 24 bit) Audio Players.

SOURCE DIRECT

Lets you enjoy high quality sound from the music source selected by the INPUT SELECTOR.

Contents

Caution: Read the pages marked  carefully to ensure safe operation.

Before applying power	2
 Before applying power		2
 Safety precautions		2
Special features	3
IMPORTANT SAFEGUARDS	4
System connection	6
The system control connections (KAF-3030R only)		7
Connection of speakers		8
Controls and indicators	9
Main unit		9
Remote control unit (KAF-3030R only)		10
Operation of remote control unit (KAF-3030R only)	11
Loading batteries		11
Operation procedure		11
Playing music	12
Normal Playback		12
Sound adjustment functions	13
To mute sound temporarily		13
Adjusting the left/right sound balance		13
Adjusting the tone		13
Emphasizing deep bass (LOUDNESS) (KAF-1030 only)		13
Listening to high quality sound from Advanced Digital Audio music source (Adv. DA / CD DIRECT) (KAF-3030R only)		14
Listening to high quality sound from a music source (SOURCE DIRECT)		14
Recording	15
To record a music source		15
To listen through headphones		15
In case of difficulty	16
 Specifications	17

Accessories

Remote control unit (1)
(KAF-3030R only)

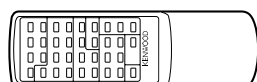

Batteries (R6/SUM-3) (2)
(KAF-3030R only)

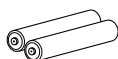

IMPORTANT SAFEGUARDS

! Caution: Read this page carefully to ensure safe operation.

KAF-3030R/1030 (En)

4

Please read all of the safety and operating instructions before operating this appliance. Adhere to all warnings on the appliance and in the instruction manual. Follow all the safety and operating instructions. These safety and operating instructions should be retained for future reference.

- 1. Power sources** – The appliance should be connected to a power supply only of the type described in the instruction manual or as marked on the appliance. If you are not sure of the type of power supply to your home, consult your appliance dealer or local power company. For appliances intended to operate from battery power, or other sources, refer to the instruction manual.
- 2. Power-cord protection** – Power-supply cords should be routed so that they are not likely to be walked on or pinched by items placed upon or against them, pay particular attention to cords at plugs, convenience receptacles, and the point where they exit from the appliance.

Never pull or stretch the cord.



- 3. CAUTION – Polarization** – This appliance may be equipped with a polarized alternating-current line plug (a plug having one blade wider than the other). This plug will fit into the power outlet only one way. This is a safety feature. If you are unable to insert the plug fully into the outlet, try reversing the plug. If the plug should still fail to fit, contact your electrician to replace your obsolete outlet. Do not defeat the safety purpose of the polarized plug.

- 4. Ventilation** – Slots and openings in the cabinet are provided for ventilation and to ensure reliable operation of the appliance and to protect it from overheating, and these openings must not be blocked or covered. The appliance should be situated so that its location or position does not interfere with its proper ventilation.

To maintain good ventilation, do not put records or a table-cloth on the appliance. Place the appliance at least 10 cm away from the walls.

Do not use the appliance on a bed, sofa, rug or similar surface that may block the ventilation openings. This appliance should not be placed in a built-in installation such as a bookcase or rack unless proper ventilation is provided or the manufacturer's instructions have been adhered to.

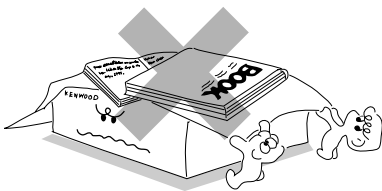

- 5. Water and moisture** – The appliance should not be used near water - for example, near a bathtub, washbowl, kitchen sink, laundry tub, in a wet basement, or near a swimming pool, etc.

- 6. Temperature** – The appliance may not function properly if used at extremely low, or freezing temperatures. The ideal ambient temperature is above +5°C (41°F).

- 7. Heat** – The appliance should be situated away from heat sources such as radiators, heat registers, stoves, or other appliances (including amplifiers) that produce heat.

- 8. Electric shock** – Care should be taken so that objects do not fall and liquid is not spilled into the enclosure through openings. If a metal object, such as a hair pin or a needle, comes into contact with the inside of this appliance, a dangerous electric shock may result. For families with children, never permit children to put anything, especially metal, inside this appliance.

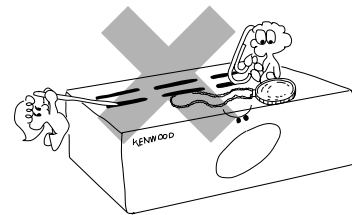

- 9. Enclosure removal** – Never remove the enclosure. If the internal parts are touched accidentally, a serious electric shock might occur.

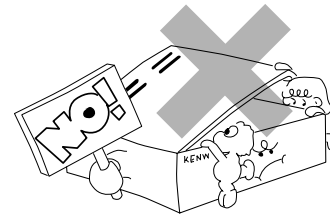

- 10. Magnetic fields** – Keep the appliance away from sources of magnetic fields such as TV sets, speaker systems, radios, motorized toys or magnetized objects.

- 11. Cleaning** – Unplug this appliance from the wall outlet before cleaning. Do not use volatile solvents such as alcohol, paint thinner, gasoline, or benzine, etc. to clean the cabinet. Use a clean dry cloth.

- 12. Accessories** – Do not place this appliance on an unstable cart, stand, tripod, bracket, or table. The appliance may fall, causing serious injury to a child or adult, and serious damage to the appliance. Use only with a cart, stand, tripod, bracket, or table recommended by the manufacturer, or sold with the appliance. Any mounting of the appliance should follow the manufacturer's instructions, and should use a mounting accessory recommended by the manufacturer. An appliance and cart combination should be moved with care. Quick stops, excessive force, and uneven surfaces may cause the appliance and cart combination to overturn.



13. Lightning – For added protection for this appliance during a lightning storm, or when it is left unattended and unused for long periods of time, unplug it from the wall outlet and disconnect the antenna or cable system. This will prevent damage to the appliance due to lightning and power-line surges.

14. Abnormal smell – If an abnormal smell or smoke is detected, immediately turn the power OFF and unplug the appliance from the wall outlet. Contact your dealer or nearest service center.

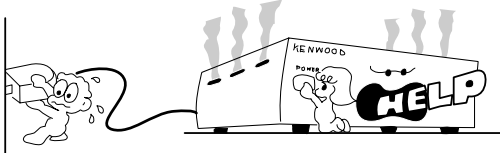

15. Damage requiring service – The appliance should be serviced by qualified service personnel when:

- A.** The power-supply cord or the plug has been damaged.
- B.** Objects have fallen, or liquid has been spilled into the appliance.
- C.** The appliance has been exposed to rain or water.
- D.** The appliance does not appear to operate normally by following the instruction manual. Adjust only those controls that are covered by the instruction manual as an improper adjustment of other controls may result in damage and will often require extensive work by a qualified technician to restore the appliance to its normal operation.
- E.** The appliance has been dropped, or the enclosure damaged.
- F.** The appliance exhibits a marked change in performance.

16. Servicing – The user should not attempt to service the appliance beyond that described in the instruction manual. All other servicing should be referred to qualified service personnel.

17. Outdoor antenna grounding – If an outside antenna is connected to the appliance, be sure the antenna system is grounded so as to provide some protection against voltage surges and built up static charges. Article 810 of the National Electrical Code ANSI/NFPA 70, provides information with respect to proper grounding of the mast and supporting structure, grounding of the lead-in wire to an antenna discharge unit, size of grounding conductors, location of antenna discharge unit, connection to grounding electrodes, and requirements for the grounding electrode. See Figure.

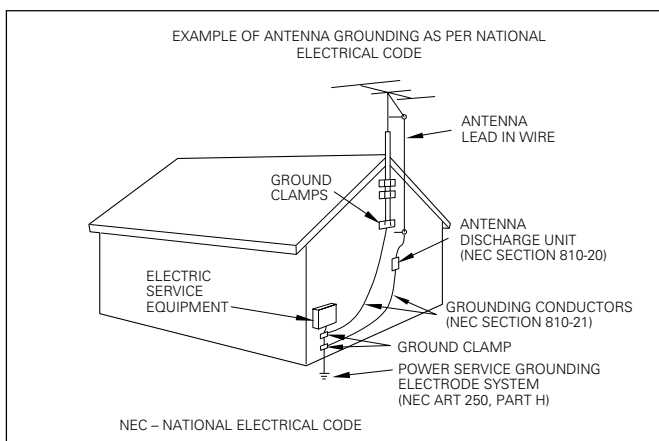

18. Power lines – An outside antenna system should not be located in the vicinity of overhead power lines or other electric light or power circuits, or where it can fall into such power lines or circuits. When installing an outside antenna system, extreme care should be taken to keep from touching such power lines or circuits as contact with them might be fatal.

19. AC outlets – Do not connect other audio equipment with a power consumption larger than that specified to the AC outlet on the rear panel. Never connect other electrical appliances, such as an iron or toaster, to it to prevent fire or electric shock.

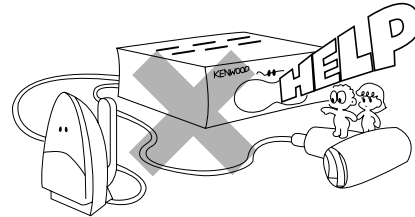

20. Overloading – Do not overload wall outlets, extension cords, or integral convenience receptacles as this can result in a risk of fire or electric shock.

21. Attachment – Do not use attachments not recommended by the appliance manufacturer as they may cause hazards.

22. Replacement parts – When replacement parts are required, be sure the service technician has used replacement parts specified by the manufacturer or have the same characteristics as the original parts. Unauthorized substitutions may result in fire, electric shock, or other hazards.

23. Safety check – Upon completion of any service or repairs to this appliance, ask the service technician to perform safety checks to determine that the appliance is in proper operating condition.

Notes:

- 1. Item 3 is not required except for grounded or polarized equipment.
- 2. Item 17 and 18 are not required except for units provided with antenna terminals.
- 3. Item 17 complies with UL in the U.S.A.

System connection

KAF-3030R/1030 (En)

6

Make connections as shown below.

When connecting the related system components, refer also to the instruction manuals of the related components.

Do not plug in the power lead until all connections are completed.

Malfunction of microcomputer



If operation is not possible or erroneous display appears even though all connections have been made properly, reset the microcomputer referring to "In case of difficulty".

16

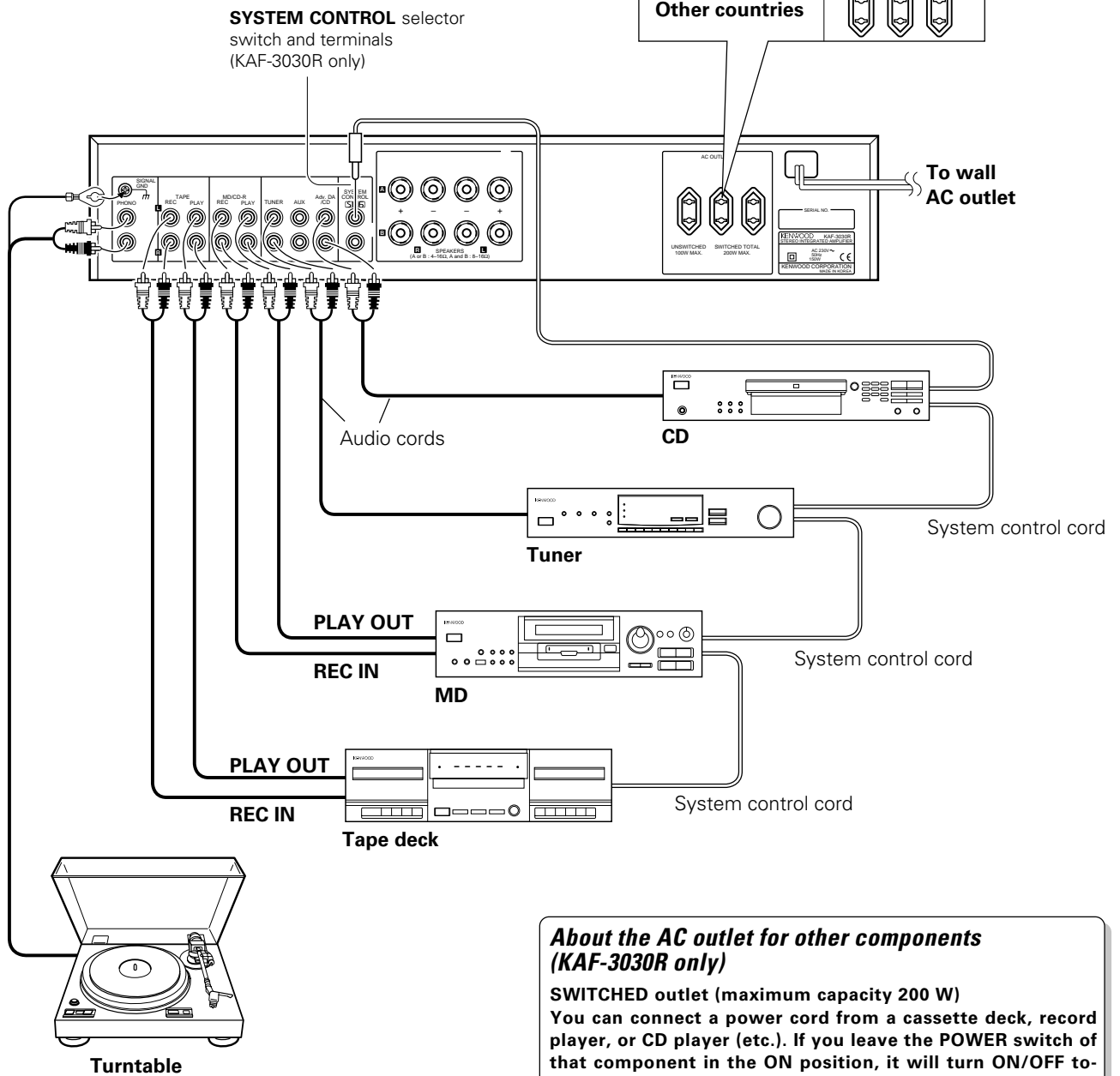

AC outlets (KAF-3030R only)

* Caution (for UK)

When using the AC outlets equipped with unit, be sure to consult your dealer for the corresponding plug.

Shape of AC outlets



Caution regarding placement

To maintain proper ventilation, be sure to leave a space around the unit (from the largest outer dimensions including projections) equal to, or greater than, shown below.

Left and right panels: 10 cm, Rear panel: 10 cm, Top panel: 50 cm

About the AC outlet for other components (KAF-3030R only)

SWITCHED outlet (maximum capacity 200 W)

You can connect a power cord from a cassette deck, record player, or CD player (etc.). If you leave the POWER switch of that component in the ON position, it will turn ON/OFF together with the REMOTE POWER key on this unit, for your convenience. Do not connect a component that consumes more than 200 W total.

UNSWITCHED outlet (maximum capacity 100 W) (except UK)

You can connect a power cord from an audio component that doesn't need to turn ON/OFF together with the REMOTE POWER key on this unit. Do not connect a component that consumes more than 100 W total.

The system control connections (KAF-3030R only)

SYSTEM CONTROL CONNECTIONS

Connecting system control cords after connecting a KENWOOD audio component system lets you take advantage of convenient system control operations.

This unit is compatible only with the [SL16] mode. The system control operation is not available if the unit is connected in the [XS-8] connection mode.

Note

Adv. DA / CD inputs:

For SYSTEM CONTROL connection of a CD player.

MD / CD-R inputs:

For SYSTEM CONTROL connection of an MD player.

- Do this operation after completing all connections.
(Ensure that the power plug is not connected.)



1. [SL16] equipment cannot be combined with [XR], [XS], and [XS8] equipment for system operations. If your equipment consists of this kind of combination, please do not connect any system control cords. Even without system control cords, normal operations can be carried out without affecting performance.
2. If your amp or receiver does not have a system control terminal, do not connect any system control cords to the system control terminals on the other components.
3. Do not connect system control cords to any components other than those specified by KENWOOD. It may cause a malfunction and damage your equipment.
4. Be sure the system control plugs are inserted all the way in to the system control terminals.

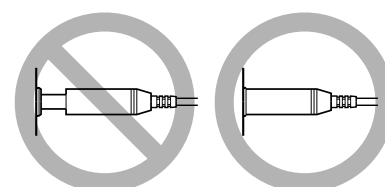

The system control operations

Remote Control

The remote control supplied with this unit can also be used to control the other components in the system.

Automatic Operation (except [XR] and [XS-8] equipment)

When you start playback from a source component, the input selector on this unit switches to that component automatically.

Synchronized Recording (except [XR] and [XS-8] equipment)

Lets you synchronize recording with the start of playback when recording from CD or MD.

8 Connection of speakers

Connect the speakers as shown below, ensuring that bare wires do not make contact with other terminals.

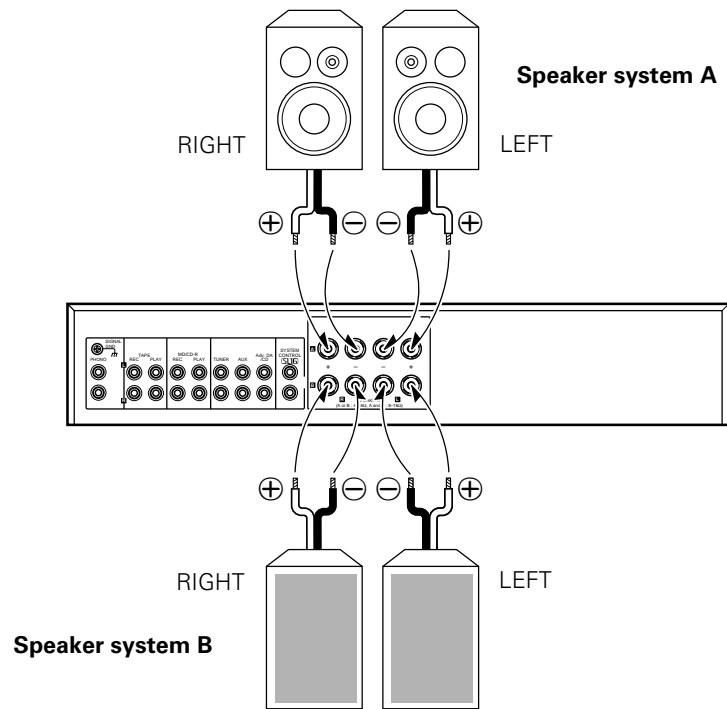
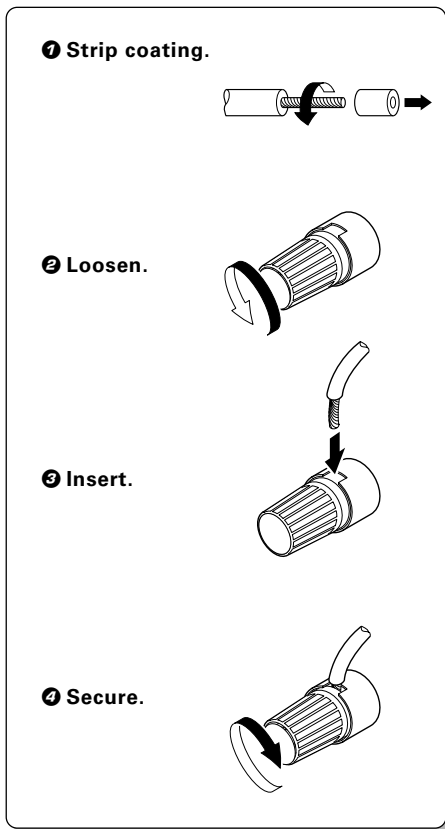

- Never short-circuit the + and – speaker cords.
- If the left and right speakers are connected inversely or if the speaker cords are connected with reversed polarity, the sound becomes unnatural with ambiguous acoustic image positioning. Be sure to connect the speakers and speaker cords correctly.

Speaker impedance

When only one pair of speakers is connected to A or B speaker terminals, use the speakers having an impedance of 4 to 16 Ω .

When two pairs of speakers are connected to both A and B terminals simultaneously, use the speakers having an impedance of 8 to 16 Ω . In this case, connecting a speaker having an impedance of less than 8 Ω may cause malfunction of the amplifier.



- 1 Connect all cords firmly. If connections are loose, there could be loss of sound or noise produced.
- 2 When plugging and unplugging connection cords, be sure to first remove the power cord from the AC outlet. Plugging/unplugging connection cords without removal of the power cord can cause malfunctions or damage to the unit.
- 3 Do not connect up a power source which is larger than that indicated on the socket at the rear of the unit.

Main unit

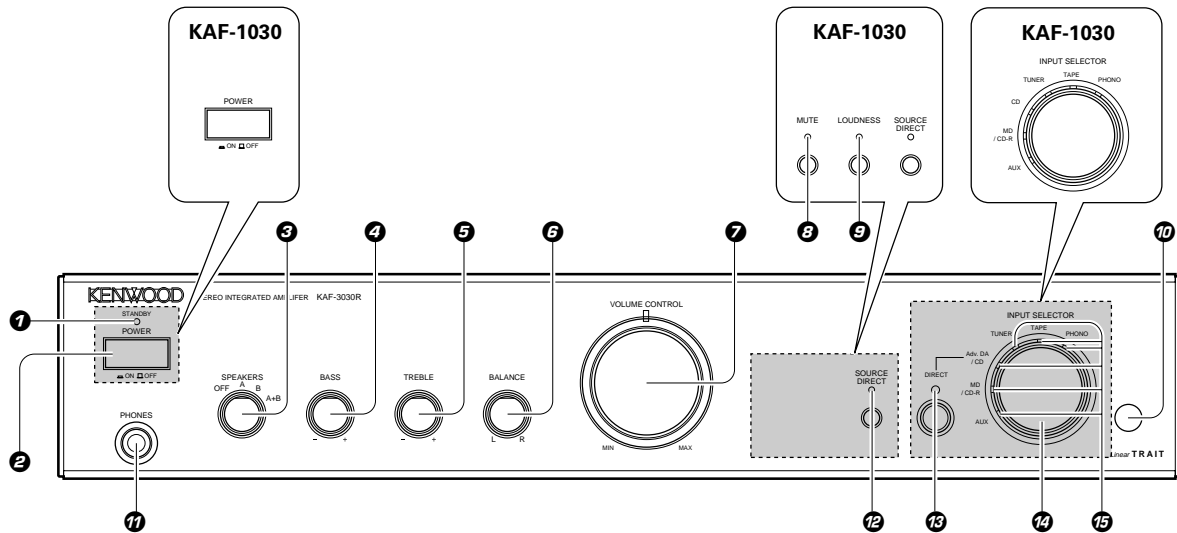

1 **STANDBY indicator (KAF-3030R only)**



2 **POWER switch**



3 **SPEAKERS A/B switches**



Turn to select the A and/or B speakers systems.

4 **BASS knob**



To adjust low frequencies.

5 **TREBLE knob**



To adjust high frequencies.

6 **BALANCE knob**



Adjust the volume balance between left and right.

7 **VOLUME CONTROL knob**



Adjust the volume.

8 **MUTE key/indicator (KAF-1030 only)**



Mute the sound temporarily.

9 **LOUDNESS key/indicator (KAF-1030 only)**



Use to emphasize deep bass sounds.

10 **Remote Sensor (KAF-3030R only)**



11 **PHONES jack**



Used for headphone listening.

12 **SOURCE DIRECT key/indicator**



To listen to a source with high quality sound.

13 **Adv. DA / CD DIRECT key/indicator (KAF-3030R only)**



To listen to a Advanced Digital Audio source with high quality sound.

14 **INPUT SELECTOR knob**



Turn to select the input sources.

15 **INPUT indicator**



An indicator lights for the source selected with the **INPUT SELECTOR** knob.

About the standby indicator (KAF-3030R only)

This unit has a standby indicator that lights to show that a small amount of current is being supplied to the unit in order to preserve the memory. This is called the Standby mode. When the Standby indicator is lit, the amplifier can be switched **ON/STANDBY** from the remote control.

10 Remote control unit (KAF-3030R only)

The  part of the illustration designates keys that can be used to operate KENWOOD components connected with the system control. The rest of the illustration designates keys that have the same functions as the keys on the main unit.

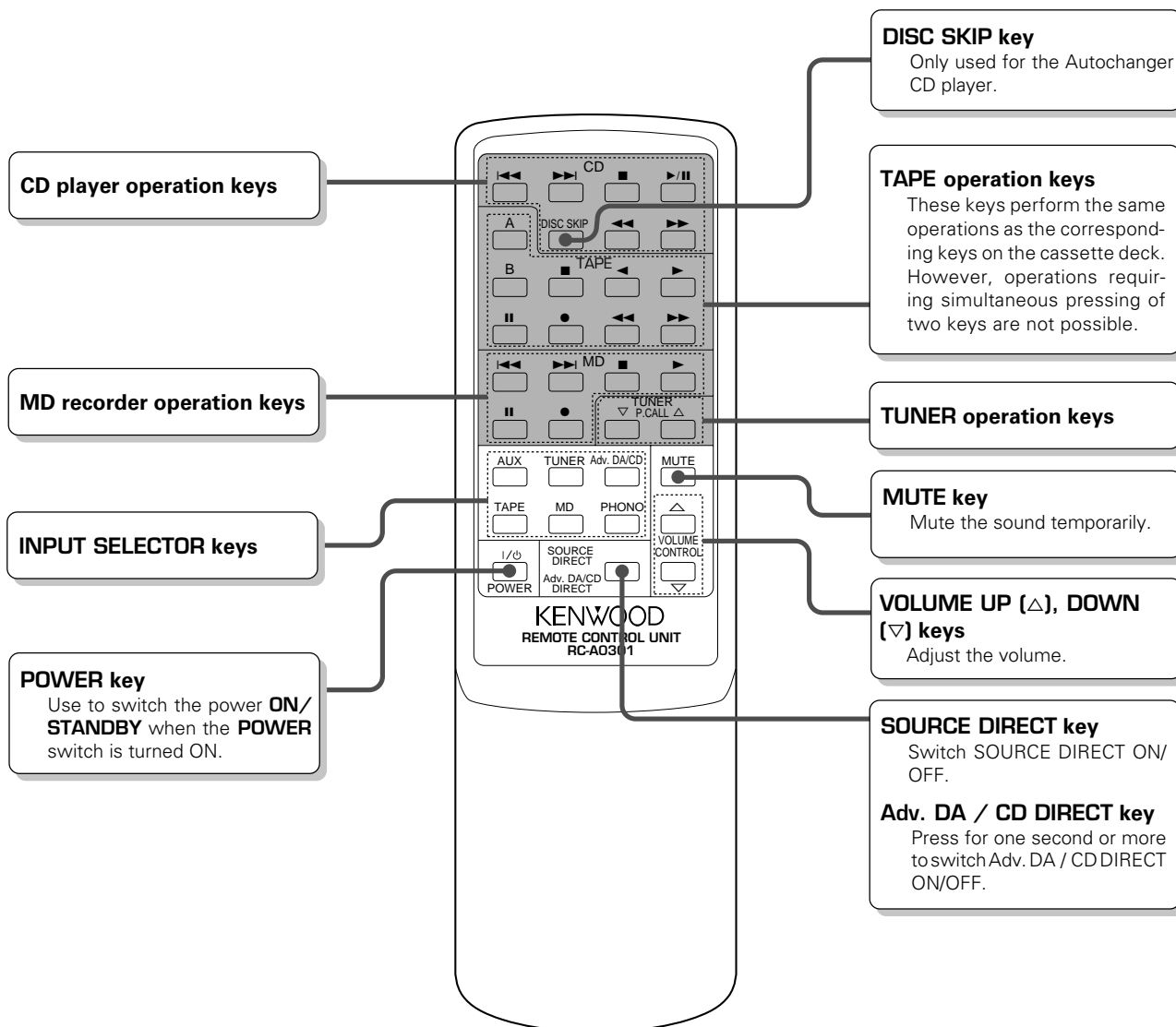

Model: RC-A0301
Infrared ray system

Loading batteries

1 Remove the cover.

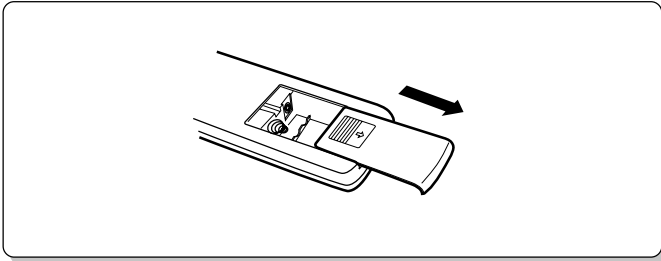

2 Insert batteries.

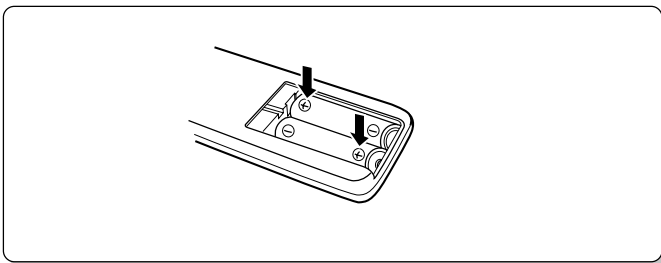

3 Close the cover.

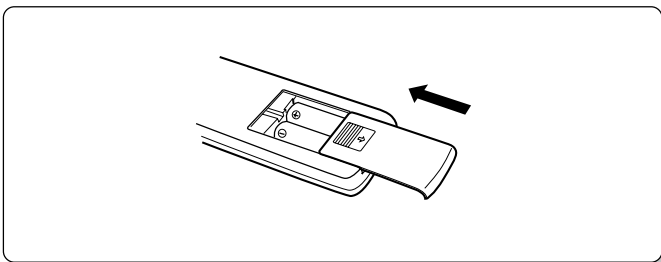

- Insert two AA-size (R6/SUM-3) batteries as indicated by the polarity marking.

Operation procedure

Pressing the **POWER** key on the remote control when the standby indicator is lit turns **ON** the power. After the power comes **ON**, press the key you want to operate.

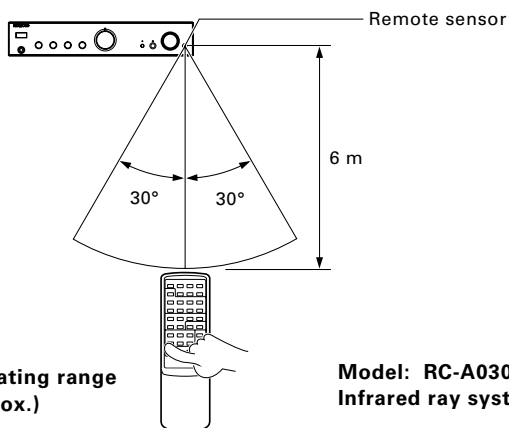

- When two operation keys on the remote control unit are pressed successively, press each key securely reserving an interval of more than 1 second for each press.



1. The supplied batteries are intended for use in operation checks. Therefore, their lives may be shorter than ordinary batteries.
2. When the remote-controllable distance gets shorter than before, replace both batteries with new ones.
3. Malfunction may occur if direct sunlight or the light of a high-frequency lighting fluorescent lamp enters the remote control light sensor. In such a case, change the system installation position to prevent the malfunction.

Playing music

Preparation

KAF-3030R

KAF-1030

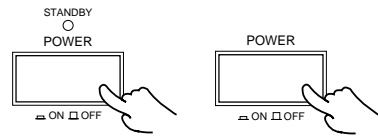

- Set the **POWER** key to the **ON** position.
- When the **POWER** switch of the **KAF-3030R** is left **ON** at all times, the power can be switched on and off with the remote control unit.

The figure shows an example for the **KAF-3030R**.

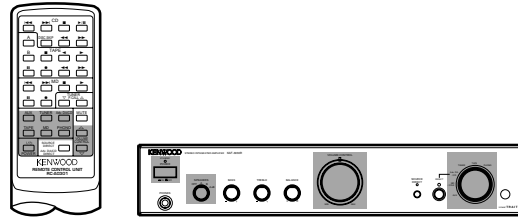

: Keys or controls to be used in this operation.

Normal playback

1 Select the **SPEAKERS** switch setting.

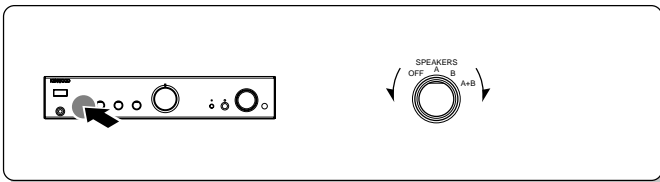

2 Select the input source.

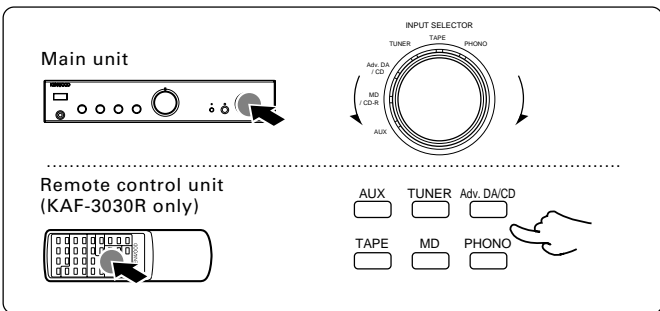

OFF:

Set to this position when listening to the sound with stereo headphones only. Sound cannot be heard from the speakers.

A:

Set to this position when listening to the sound with the speakers connected to the **SPEAKERS A** terminals.

B:

Set to this position when listening to the sound with the speakers connected to the **SPEAKERS B** terminals.

A+B:

Set to this position when listening to the two pairs of speakers connected to both **SPEAKERS A** and **SPEAKERS B** terminals simultaneously.

One lights.

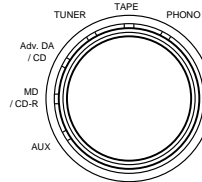

- The indicator for the selected source lights.

3 Play the selected source.

4 Adjust the volume.

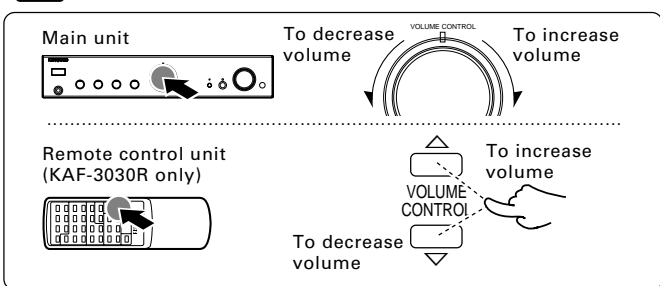

Sound adjustment functions

The figure shows an example for the KAF-3030R.

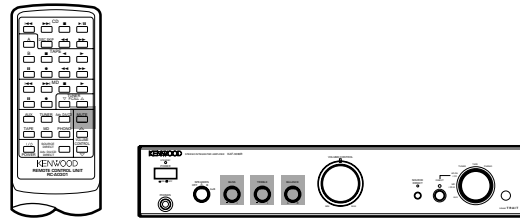

 : Keys or controls to be used in this operation.

To mute sound temporarily

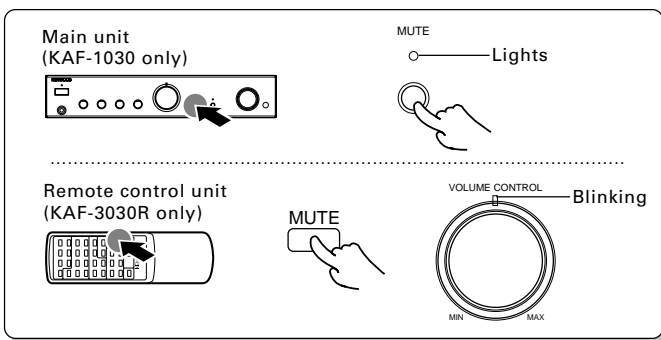

- When you press again, the volume returns to the original level and the **MUTE** indicator goes out.

- When you press again, the volume returns to the original level and the **VOLUME** indicator lights.

Adjusting the left/right sound balance

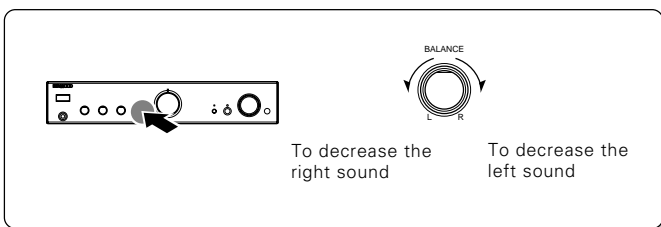

- Make sure the **SOURCE DIRECT** and **Adv. DA / CD DIRECT** (KAF-3030R only) indicator is not lit. → 14

Adjusting the tone

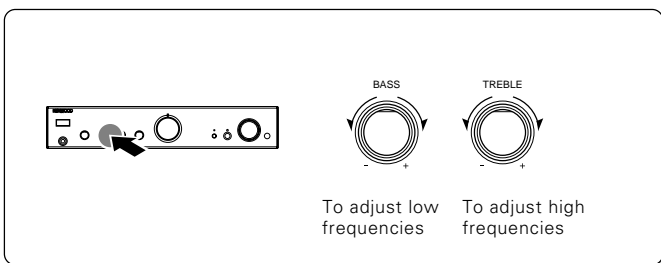

- Make sure the **SOURCE DIRECT** and **Adv. DA / CD DIRECT** (KAF-3030R only) indicator is not lit. → 14

Emphasizing deep bass (LOUDNESS) (KAF-1030 only)

Lets you emphasize the sound of deep bass when listening at low volumes.

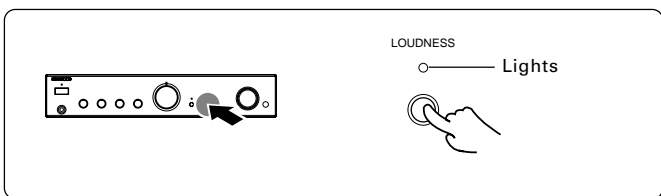



- Make sure the **SOURCE DIRECT** indicator is not lit. → 14

To cancel LOUDNESS
Press the **LOUDNESS** key again.

- The **LOUDNESS** indicator goes out.

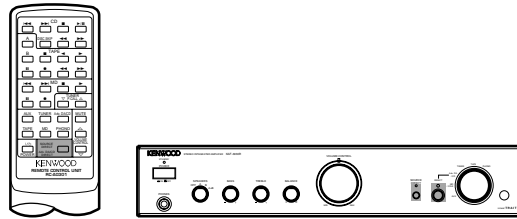
The figure shows an example for the KAF-3030R.



 : Keys or controls to be used in this operation.

Listening to high quality sound from Advanced Digital Audio music source (Adv. DA / CD DIRECT) (KAF-3030R only)

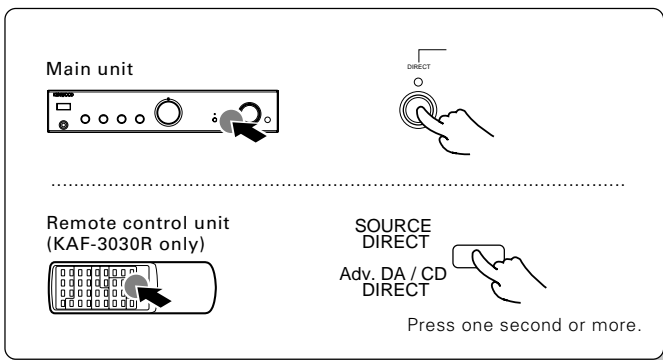

- **Adv. DA / CD DIRECT** input is selected regardless of the source selected by the **INPUT SELECTOR**.
- Tone adjustment and balance do not work when **Adv. DA / CD DIRECT** is ON (when the **Adv. DA / CD DIRECT** indicator is lit).

To cancel Adv. DA / CD DIRECT

Main unit Press the Adv. DA / CD DIRECT key again.

Remote

control unit..... Press the Adv. DA / CD DIRECT key again for one second or more.

- The **Adv. DA / CD DIRECT** indicator goes out.

Listening to high quality sound from a music source (SOURCE DIRECT)

Use this mode to avoid unnecessary circuitry during playback when you want to listen to high quality sound.

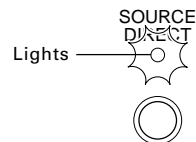
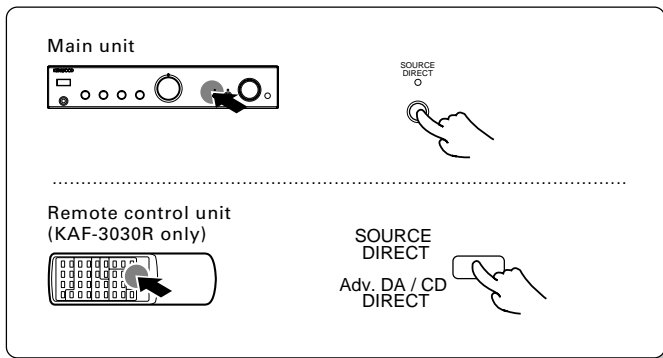

- Tone adjustment, balance and **LOUDNESS** do not work when **SOURCE DIRECT** is ON (when the **SOURCE DIRECT** indicator is lit).

To cancel SOURCE DIRECT

Press the **SOURCE DIRECT** key again.

- The **SOURCE DIRECT** indicator goes out.

The figure shows an example for the KAF-3030R.



 : Keys or controls to be used in this operation.

To record a music source

1 Select the source to be recorded.

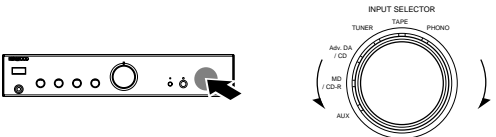

2 Put the cassette deck or MD recorder in record-pause mode.

3 Play the source and start recording.

One lights.

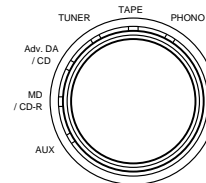

- The indicator for the selected source lights.
- When **TAPE** is selected with the **INPUT SELECTOR**, recording is possible with the MD recorder.
- When **MD** is selected with the **INPUT SELECTOR**, recording is possible with the Tape deck.

To listen through headphones

1 Set of the SPEAKERS switches to OFF.



2 Plug headphones.

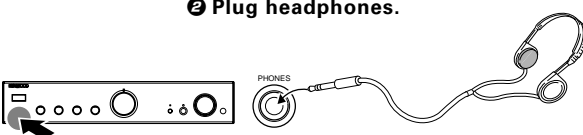

3 Adjust the volume.

Main unit

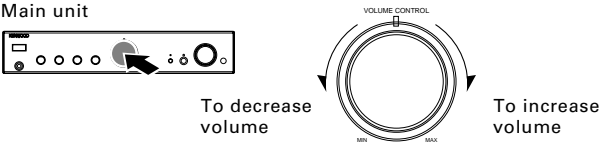

To decrease volume To increase volume

Remote control unit (KAF-3030R only)

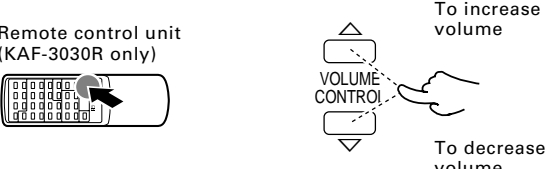

To increase volume

To decrease volume

In case of difficulty

What appears to be a malfunction may not always be serious. If your unit should not perform as expected, consult the table below to see if the problem can be corrected before seeking help from your dealer or service representative.

Operation to reset

The microcomputer may fall into malfunction (impossibility to operate, erroneous display, etc.) when the power cord is unplugged while power is ON or due to an external factor. In this case, execute the following procedure to reset the microcomputer and return it to normal condition.

Set the **POWER** to OFF then, while holding down the **SOURCE DIRECT** key, set the **POWER** switch to ON.

- Please note that resetting the microcomputer clears the contents stored in it and returns it to the condition when it left the factory.

Remote control unit (KAF-3030R only)

Symptom	Cause	Remedy
Remote control operation is not possible.	<ul style="list-style-type: none"> • Batteries are exhausted. • The remote control unit is too far away from the main system, controlling angle is too large, or there is an obstacle in between. • The audio cords and system control cords are not connected properly. • The source component to be operated does not contain the tape(s), CD or MD. • The POWER switch is set to OFF. 	<ul style="list-style-type: none"> • Replace with new batteries. → • Operate the remote control unit within the controllable range. → • Connect properly referring to "System connection". → → • Place the tape(s), CD or MD in the source component to be played. • Set the POWER switch to ON. →

Amplifier

Symptom	Cause	Remedy
Sound is not output.	<ul style="list-style-type: none"> • The speaker cords are disconnected. • The VOLUME CONTROL is set to the minimum position. • MUTING is ON. • The SPEAKERS switches are set to OFF. • The system control cords are not fully connected. 	<ul style="list-style-type: none"> • Connect them properly referring to "System connection". → • Adjust the volume to a proper level. → • Press the MUTE key to OFF. → • Set the SPEAKERS switch(es) to ON. → • Check the system control connections. → →
All indicators blink and sound is not output.	<ul style="list-style-type: none"> • Speaker cords are short-circuited. 	<ul style="list-style-type: none"> • Turn the power off, eliminate the short-circuiting, then turn on the power again.
Sound is not output from one of the speakers.	<ul style="list-style-type: none"> • The speaker cord is disconnected. • The BALANCE control is set to an extreme position. 	<ul style="list-style-type: none"> • Connect it properly referring to "System connection". → • Adjust the Left/Right balance. →
No sound from a selected source. (KAF-3030R only)	<ul style="list-style-type: none"> • Adv. DA / CD DIRECT is ON. (KAF-3030R only) 	<ul style="list-style-type: none"> • Press the Adv. DA / CD DIRECT key to OFF. (KAF-3030R only)

Notes

The RDS EON function

- When this unit is connected to a KENWOOD tuner with the RDS EON function using a system control cord, the input of this unit automatically switches to the tuner when the tuner receives a desired program in the EON reservation mode.
- Note that the RDS EON function is not available while the Adv. **DA / CD DIRECT** is ON.

Speaker protection circuit

When this unit's power is turned ON with the speaker cable short-circuited, the speaker protection functions. If the all indicators blink and no sound occurs, turn the power OFF, remove the short-circuit, then turn the power ON again.



Do not use contact cleaners because they could cause a malfunction. Be specially careful of contact cleaners containing oil, for they may deform the plastic components.

KAF-3030R

Rated output power	
(DIN) 1 kHz	
at 8 Ω	50 W + 50 W
at 4 Ω	75 W + 75 W
(IEC/DIN) from 63 Hz to 12.5 kHz, 0.7 % T.H.D.	
at 8 Ω	50 W + 50 W
at 4 Ω	75 W + 75 W
Effective output power	
Except UK and Europe	
(EIAJ) 1 kHz, 10 % T.H.D.	
at 8 Ω	60 W + 60 W
at 4 Ω	90 W + 90 W
Damping factor	42 (50 Hz)
Total harmonic distortion	
.....	0.02 % (20 Hz ~ 20 kHz, 25 W, 8 Ω)
.....	0.002 % (1 kHz, 25 W, 8 Ω)
Frequency response (IHF'66)	
Adv. DA / CD DIRECT	5 Hz ~ 100 kHz, +0 dB, -3 dB
Adv. DA / CD, MD/CD-R,	
TUNER, TAPE, AUX	5 Hz ~ 60 kHz, +0 dB, -3 dB
PHONO 'RIAA' response ...	20 Hz ~ 20 kHz, +1.0 dB, -1.0 dB
Maximum input level	
PHONO (MM)	100 mV, 0.5 % T.H.D. at 1 kHz
Signal to noise ratio	
PHONO (MM)	72 dB (IHF'66)
Adv. DA / CD, MD/CD-R,	
TUNER, TAPE, AUX	100 dB (IHF'66)
Adv. DA / CD DIRECT	102 dB (IHF'66)
PHONO (MM)	60 dB (DIN, 50 mW output)
Adv. DA / CD, MD/CD-R,	
TUNER, TAPE, AUX	60 dB (DIN, 50 mW output)
Input sensitivity/impedance	
PHONO (MM)	2.5 mV/33 kΩ
Adv. DA / CD, MD/CD-R,	
TUNER, TAPE, AUX	200 mV/47 kΩ
Tone control	
BASS	±6 dB (at 100 Hz)
TREBLE	±6 dB (at 10 kHz)
Output level/impedance	
MD/CD-R REC, TAPE REC,	200 mV/2.7 kΩ
General	
Power consumption	150 W
AC outlet	
SWITCHED	2 (total 200 W max.)
UNSWITCHED	1 (100 W max.)
Dimensions	W: 440 mm
	H: 95 mm
	D: 400 mm
Weight (net)	7.8 kg

KAF-1030

Rated output power	
(DIN) 1 kHz	
at 8 Ω	40 W + 40 W
at 4 Ω	60 W + 60 W
(IEC/DIN) from 63 Hz to 12.5 kHz, 0.7 % T.H.D.	
at 8 Ω	40 W + 40 W
at 4 Ω	60 W + 60 W
Effective output power	
Except UK and Europe	
(EIAJ) 1 kHz, 10 % T.H.D.	
at 8 Ω	55 W + 55 W
at 4 Ω	75 W + 75 W
Damping factor	42 (50 Hz)
Total harmonic distortion	
.....	0.02 % (20 Hz ~ 20 kHz, 20 W, 8 Ω)
.....	0.002 % (1 kHz, 20 W, 8 Ω)
Frequency response (IHF'66)	
SOURCE DIRECT	5 Hz ~ 85 kHz, +0 dB, -3 dB
CD, MD/CD-R,	
TUNER, TAPE, AUX	5 Hz ~ 60 kHz, +0 dB, -3 dB
PHONO 'RIAA' response ...	20 Hz ~ 20 kHz, +1.0 dB, -1.0 dB
Maximum input level	
PHONO (MM)	100 mV, 0.5 % T.H.D. at 1 kHz
Signal to noise ratio	
PHONO (MM)	72 dB (IHF'66)
CD, MD/CD-R, TUNER, TAPE, AUX	100 dB (IHF'66)
PHONO (MM)	60 dB (DIN, 50 mW output)
CD, MD/CD-R,	
TUNER, TAPE, AUX	60 dB (DIN, 50 mW output)
Input sensitivity/impedance	
PHONO (MM)	2.5 mV/33 kΩ
CD, MD/CD-R, TUNER, TAPE, AUX	200 mV/47 kΩ
Tone control	
BASS	±6 dB (at 100 Hz)
TREBLE	±6 dB (at 10 kHz)
LOUDNESS control	
VOLUME at -30 dB level	+9 dB (at 100 Hz)
Output level/impedance	
MD/CD-R REC, TAPE REC,	200 mV/2.7 kΩ
General	
Power consumption	130 W
Dimensions	W: 440 mm
	H: 95 mm
	D: 400 mm
Weight (net)	7.2 kg



1. KENWOOD follows a policy of continuous advancements in development. For this reason specifications may be changed without notice.
2. The full performance may not be exhibited in extremely cold locations (below freezing).

KENWOOD

For your records

Record the serial number, found on the back of the unit, in the spaces designated on the warranty card, and in the space provided below. Refer to the model and serial numbers whenever you call upon your dealer for information or service on this product.

Model _____ Serial Number _____

Free Manuals Download Website

<http://myh66.com>

<http://usermanuals.us>

<http://www.somanuals.com>

<http://www.4manuals.cc>

<http://www.manual-lib.com>

<http://www.404manual.com>

<http://www.luxmanual.com>

<http://aubethermostatmanual.com>

Golf course search by state

<http://golfingnear.com>

Email search by domain

<http://emailbydomain.com>

Auto manuals search

<http://auto.somanuals.com>

TV manuals search

<http://tv.somanuals.com>