

KENWOOD

AUDIO VIDEO CONTROL CENTER

KRF-V5300D

INSTRUCTION MANUAL

Kenwood Corporation

CE **Declaration of Conformity with regard to the
EMC Directive 2004/108/EC**
Manufacturer:

Kenwood Corporation
2967-3 Ishikawa-machi, Hachioji-shi, Tokyo, 192-8525 Japan

EU Representative's:

Kenwood Electronics Europe BV
Amsterdamseweg 37, 1422 AC UITHOORN, The Netherlands



RDS

© B60-5738-00/00 (EW/XW)

Before applying power

⚠ Caution : Read this page carefully to ensure safe operation.

Units are designed for operation as follows.

Australia.....AC 240 V only
 Europe.....AC 230 V only

Information on Disposal of Old Electrical and Electronic Equipment (applicable for EU countries that have adopted separate waste collection systems)



Products with the symbol (crossed-out wheeled bin) cannot be disposed as household waste.

Old electrical and electronic equipment should be recycled at a facility capable of handling these items and their waste byproducts. Contact your local authority for details in locating a recycle facility nearest to you. Proper recycling and waste disposal will help conserve resources whilst preventing detrimental effects on our health and the environment.

Safety precautions

WARNING :

TO PREVENT FIRE OR ELECTRIC SHOCK, DO NOT EXPOSE THIS APPLIANCE TO RAIN OR MOISTURE.



CAUTION
 RISK OF ELECTRIC SHOCK
 DO NOT OPEN



CAUTION: TO REDUCE THE RISK OF ELECTRIC SHOCK, DO NOT REMOVE COVER (OR BACK). NO USER-SERVICEABLE PARTS INSIDE. REFER SERVICING TO QUALIFIED SERVICE PERSONNEL.



THE LIGHTNING FLASH WITH ARROWHEAD SYMBOL, WITHIN AN EQUILATERAL TRIANGLE, IS INTENDED TO ALERT THE USER TO THE PRESENCE OF UNINSULATED "DANGEROUS VOLTAGE" WITHIN THE PRODUCT'S ENCLOSURE THAT MAY BE OF SUFFICIENT MAGNITUDE TO CONSTITUTE A RISK OF ELECTRIC SHOCK TO PERSONS.



THE EXCLAMATION POINT WITHIN AN EQUILATERAL TRIANGLE IS INTENDED TO ALERT THE USER TO THE PRESENCE OF IMPORTANT OPERATING AND MAINTENANCE (SERVICING) INSTRUCTIONS IN THE LITERATURE ACCOMPANYING THE APPLIANCE.

Unpacking

Unpack the unit carefully and make sure that all the accessories are present.

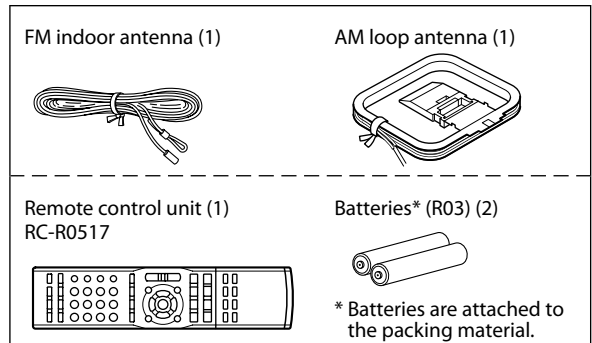

If any accessories are missing, or if the unit is damaged or fails to operate, notify your dealer immediately. If the unit was shipped to you directly, notify your shipper immediately. Kenwood recommends that you retain the original carton and packing materials in case you need to move or ship the unit in the future.

Keep this manual handy for future reference.

Notes on instructions

The operating instructions given in this manual assume that the user mainly operates the receiver using the remote control unit. When the same operation is also available on the main unit, the operating method is indicated in illustrations. The [VOLUME CONTROL], [MULTI CONTROL] and [INPUT SELECTOR] knobs on the main unit are operated by turning the knobs clockwise or counterclockwise.

Example:

Getting into the setup mode

The setup procedure is identical for all of the setting elements. Once you remember the following procedure, you can easily set up other setting elements.

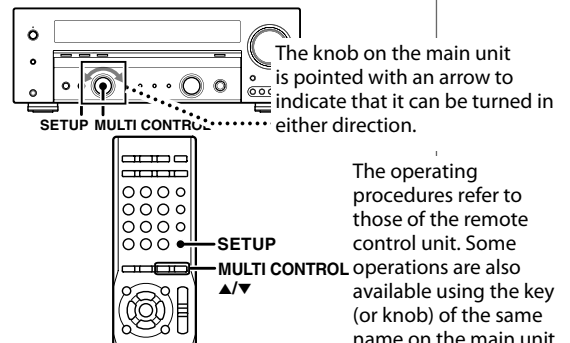

- 1 Press [SETUP] to enter the setup mode.
- 2 Use [MULTI CONTROL ▲/▼] to select the element to setup.

Display	Selection
"SP SETUP"	Speaker setup
"TEST TONE"	Test tone
"DISTANCE"	Distance
"LFE LVL"	Low frequency effects level
"EXIT"	Exit the setup mode.

- 3 Press [SETUP] to get into the setup mode of the selected element.
- Options to be selected are listed in a table.

IMPORTANT SAFETY INSTRUCTIONS

⚠ Caution : Read this page carefully to ensure safe operation.

Read Instructions – All the safety and operating instructions should be read before the product is operated.

Retain Instructions – The safety and operating instructions should be retained for future reference.

Heed Warnings – All warnings on the product and in the operating instructions should be adhered to.

Follow Instructions – All operating and use instructions should be followed.

1. Cleaning – Unplug this product from the wall outlet before cleaning. Do not use liquid cleaners or aerosol cleaners. Use a damp cloth for cleaning.

2. Attachments – Do not use attachments not recommended by the product manufacturer as they may cause hazards.

3. Water and Moisture – This product shall not be exposed to dripping and splashing – for example, near a bath tub, wash bowl, kitchen sink, or laundry tub; in a wet basement; or near a swimming pool; and the like. Do not place an object containing liquid, such as a flower vase, on the appliance.

4. Accessories – Do not place this product on an unstable cart, stand, tripod, bracket, or table. The product may fall, causing serious injury to a child or adult, and serious damage to the product. Use only with a cart, stand, tripod, bracket, or table recommended by the manufacturer. Any mounting of the product should follow the manufacturer's instructions, and should use a mounting accessory recommended by the manufacturer. A product and cart combination should be moved with care. Quick stops, excessive force, and uneven surfaces may cause the product and cart combination to overturn.



5. Ventilation – Slots and openings in the cabinet are provided for ventilation and to ensure reliable operation of the product and to protect it from overheating, and these openings must not be blocked or covered. The openings should never be blocked by placing the product on a bed, sofa, rug, or other similar surface. This product should not be placed in a built-in installation such as a bookcase or rack unless proper ventilation is provided or the manufacturer's instructions have been adhered to.

6. Power Sources – This product should be operated only from the type of power source indicated on the product. If you are not sure of the type of power supply to your home, consult your product dealer or local power company.

7. CAUTION – Polarization – This product may be equipped with a polarized alternating-current line plug (a plug having one blade wider than the other). This plug will fit into the power outlet only one way. This is a safety feature. If you are unable to insert the plug fully into the outlet, try reversing the plug. If the plug should still fail to fit, contact your electrician to replace your obsolete outlet. Do not defeat the safety purpose of the polarized plug.

8. Power Cord Protection – Power-supply cords should be routed so that they are not likely to be walked on or pinched by items placed upon or against them, paying particular attention to cords at plugs, convenience receptacles, and the point where they exit from the product.

9. Lightning – For added protection for this product during a lightning storm, or when it is left unattended and unused for long periods of time, unplug it from the wall outlet and disconnect the antenna or cable system. This will prevent damage to the product due to lightning and power-line surges.

10. Overloading – Do not overload wall outlets, extension cords, or integral convenience receptacles as this can result in a risk of fire or electric shock.

11. Object and Liquid Entry – Never push objects of any kind into this product through openings as they may touch dangerous voltage points or short-out parts that could result in a fire or electric shock. Never spill liquid of any kind on the product.

12. Servicing – Do not attempt to service this product yourself as opening or removing covers may expose you to dangerous voltage or other hazards. Refer all servicing to qualified service personnel.

13. Damage Requiring Service – Unplug this product from the wall outlet and refer servicing to qualified service personnel under the following conditions:

- When the power-supply cord or plug is damaged,
 - If liquid has been spilled, or objects have fallen into the product,
 - If the product has been exposed to rain or water,
 - If the product does not operate normally by following the operating instructions.
 - If the product has been dropped or damaged in any way, and
 - When the product exhibits a distinct change in performance – this indicates a need for service.
- g)** If an abnormal smell or smoke is detected.

14. Replacement Parts – When replacement parts are required, be sure the service technician has used replacement parts specified by the manufacturer or have the same characteristics as the original part. Unauthorized substitutions may result in fire, electric shock, or other hazards.

15. Safety Check – Upon completion of any service or repairs to this product, ask the service technician to perform safety checks to determine that the product is in proper operating condition.

16. Wall or Ceiling Mounting – This product should be mounted to a wall or ceiling only as recommended by the manufacturer.

17. Heat – This product should be situated away from heat sources such as radiators, heat registers, stoves, or other products that produce heat. Do not place a flaming object, such as a candle or lantern, or near the product.

18. Power Lines – An outside antenna system should not be located in the vicinity of overhead power lines or other electric light or power circuits, or where it can fall into such power lines or circuits. When installing an outside antenna system, extreme care should be taken to keep from touching such power lines or circuits as contact with them might be fatal.

19. Outdoor Antenna Grounding – If an outside antenna or cable system is connected to the product, be sure the antenna or cable system is grounded so as to provide some protection against voltage surges and built-up static charges. Article 810 of the National Electrical Code, ANSI/NFPA 70, provides information with regard to proper grounding of the mast and supporting structure, grounding of the lead-in wire to an antenna discharge unit, size of grounding conductors, location of antenna-discharge unit, connection to grounding electrodes, and requirements for the grounding electrode.

EXAMPLE OF ANTENNA GROUNDING AS PER NATIONAL ELECTRICAL CODE

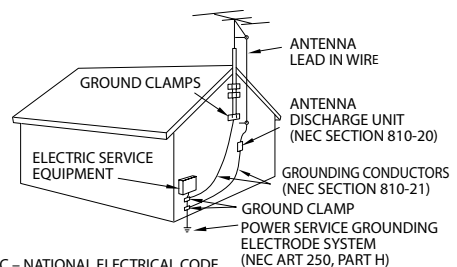



Notes:

- Item 7 is not required except for grounded or polarized equipment.
- Item 19 complies with UL in the U.S.A.

Contents

 **To ensure safety, read the items carrying this marking carefully.**

 Before applying power	2
 Safety precautions	2
Unpacking.....	2
Notes on instructions.....	2
 IMPORTANT SAFETY INSTRUCTIONS	3
Special features	4
Names and functions of parts	5
Main unit	5
Remote control unit	6
Preparing the remote control	7
Setting up the system	8
Speaker placement.....	8
Digital connections	9
Connecting a DVD player (6-channel input)	10
Connecting audio components.....	11
Connecting video components.....	12
Connecting video components (COMONENT VIDEO) (For Australia)	13
Connecting the speakers.....	14
Connecting the antennas.....	15
Connecting to the AV AUX jacks.....	15
Speaker settings	16
Speaker setup (Easy Setup)	16
Speaker setting flow	17
Getting into the setup mode	17
Speaker setup ("SP SETUP")	18
Adjusting the speaker level ("TEST TONE")	18
Distance setting ("DISTANCE")	19
Low frequency effects level ("LFE LVL")	19
Normal Playback	20
Preparing for playback	20
Listening to a source component	21
Listening to music with PURE AUDIO MODE.....	21
Adjusting the sound.....	22
Ambience effects	23
Surround modes.....	23
Surround play	25
DVD 6-channel playback	26
Listening to radio broadcasts	27
Tuning (non-RDS) radio stations	27
Using RDS (Radio Data System)	27
RDS Auto Memory	28
Presetting radio stations manually	28
Receiving preset stations	29
Receiving preset stations in order (P.CALL).....	29
Tuning by Program Type (PTY search)	30
Using the RDS DISP. (display) key	30
Recording	31
Recording mode setting in digital audio source recording (main unit only).....	31
Recording audio (analog sources)	31
Recording video.....	31

Further adjustments	32
Fine adjustment of the sound	32
Additional functions	34
Convenient functions	34
Remote control operations for Kenwood DVD players	35
Troubleshooting	36
Specifications	38

Special features

PURE AUDIO MODE 21

This is the mode for enjoying audio sources in high-quality stereo. It shuts off the power to the video circuitry as well as the display to eliminate their influence on the audio circuitry and improve the reproduced audio quality.

True home theater sound 23

This unit incorporates a wide variety of surround modes to bring you maximum enjoyment from your video software. Select a surround mode according to your equipment or the software you are going to play and enjoy!

- **Dolby Digital**
- **Dolby Pro Logic II**
- **DTS**
- **DSP surround modes**
- **DVD 6-channel input**

Names and functions of parts

Main unit

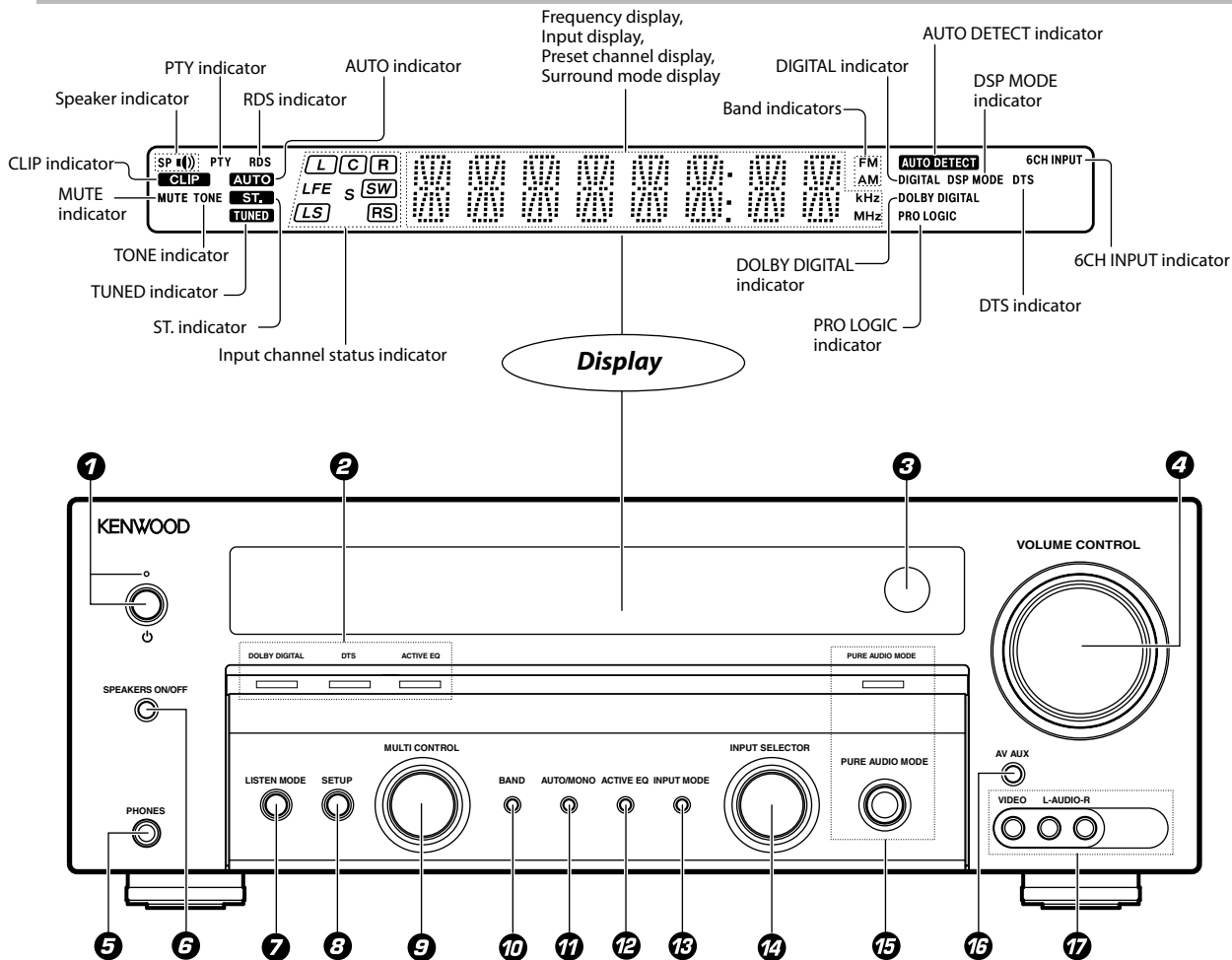

- 1** (power) key
Standby indicator
Switch the unit ON and standby. When the unit is in standby mode, the standby indicator is lit.
- 2** **Surround LED indicators**
DOLBY DIGITAL indicator
Light when this unit is in the Dolby Digital mode.
DTS indicator
Light when in the DTS mode.
ACTIVE EQ indicator
Light when in the ACTIVE EQ mode.
- 3** **Remote sensor**
- 4** **VOLUME CONTROL knob**
- 5** **PHONES jack**
Use for headphone listening.
- 6** **SPEAKERS ON/OFF key**
Use to turn the speakers ON/OFF.
- 7** **LISTEN MODE key** - 25
Use to select the listen mode.
- 8** **SETUP key** - 17
Use to select the speakers' settings etc.
- 9** **MULTI CONTROL knob**
Use to control a variety of settings.
- 10** **BAND key**
Use to select the broadcast band.
- 11** **AUTO/MONO key**
Use to select the auto tuning or manual tuning mode. - 27
- 12** **ACTIVE EQ key** - 31
Use to select a recording mode. - 22
- 13** **ACTIVE EQ key** - 22
Use to select ACTIVE EQ setting.
- 14** **INPUT MODE key** - 20
Use to switch between full auto, digital and analog inputs.
- 15** **INPUT SELECTOR knob**
Use to select the input sources.
- 16** **PURE AUDIO MODE key** - 21
PURE AUDIO MODE indicator
Use to select PURE AUDIO MODE. When this mode is on, the PURE AUDIO MODE indicator is lit.
- 17** **AV AUX key**
Use to select AV AUX source.
- 17** **AV AUX jack**
Use to connect a device such as a camcorder and a game player.

Standby mode

While the standby indicator is lit, a small amount of power is supplied to the system to back up the memory. This is called standby mode. Under the condition, the system can be turned ON by the remote control unit.

Remote control unit

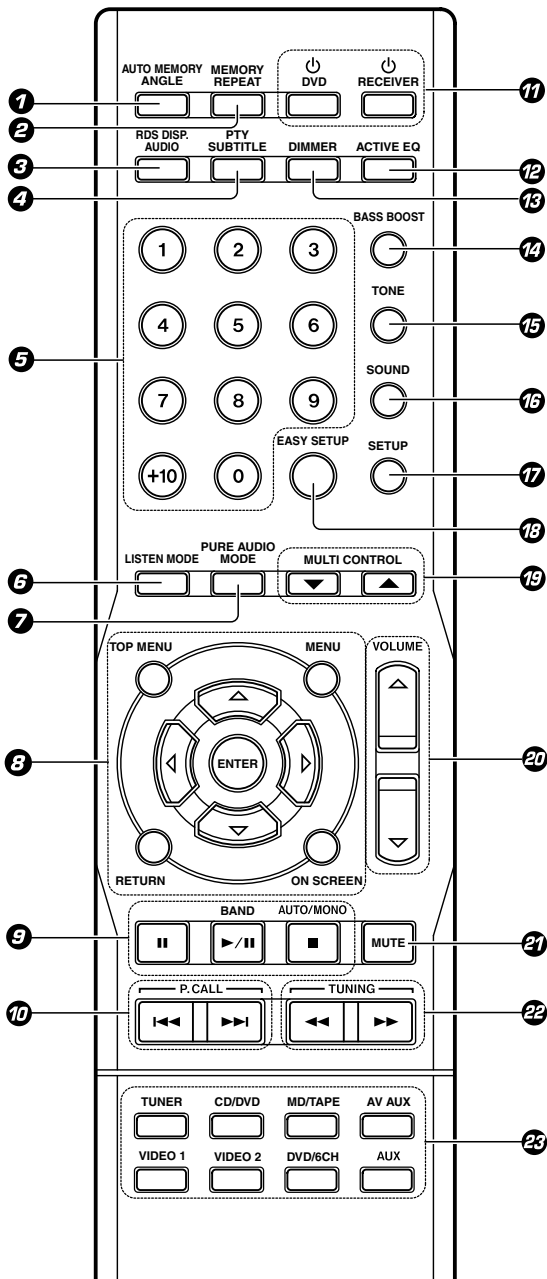

- 1 AUTO MEMORY key** → [28]
Use for auto memory of RDS and FM radio stations.
- ANGLE key**
Use to operate the Kenwood DVD player.*
- 2 MEMORY key** → [28]
Use for manual memory of radio stations.
- REPEAT key**
Use to operate the Kenwood DVD player.*
- 3 RDS DISP. key** → [30]
Use to display RDS information.
- AUDIO key**
Use to operate the Kenwood DVD player.*

- 4 PTY key** → [30]
Use for PTY search.
- SUBTITLE key**
Use to operate the Kenwood DVD player.*
- 5 Numeric keys**
Use to call up preset stations.
- 6 LISTEN MODE key** → [25]
Use to select a listen mode.
- 7 PURE AUDIO MODE key** → [21]
Select PURE AUDIO MODE.
- 8 ▲, ▼, ◀, ▶ keys**
ENTER key
TOP MENU key
MENU key
RETURN key
ON SCREEN key
Use to operate the Kenwood DVD player.*
- 9 II key**
Use to operate the Kenwood DVD player.*
- BAND key**
Use to select the broadcast band.
- ▶/II key**
Use to operate the Kenwood DVD player.*
- AUTO/MONO key** → [27]
■ key
Use to operate the Kenwood DVD player.*
- 10 P.CALL ◀◀/▶▶ keys** → [29]
Use to call preset channel.
- 11 RECEIVER key**
Use to operate the Kenwood DVD player.*
- DVD key**
Use to turn this unit on and off.
- 12 ACTIVE EQ key** → [22]
Use to turn on the Kenwood DVD player on and off.
- 13 ACTIVE EQ key** → [22]
Use to select ACTIVE EQ setting.
- 13 DIMMER key** → [34]
Use to adjust the brightness of the display and the indicators.
- 14 BASS BOOST key** → [22]
Use to select the maximum adjustment setting for the low frequency range.
- 15 TONE key** → [22]
Use to switch the status of TONE control.
- 16 SOUND key** → [32]
Use to adjust the sound quality and ambience effects.
- 17 SETUP key** → [17]
Use to select the speakers' settings.
- 18 EASY SETUP key** → [16]
Use to select speaker setting.
- 19 MULTI CONTROL ▲/▼ keys**
Select an setup item.
- 20 VOLUME ▲/▼ keys**
Use to adjust volume setting.
- 21 MUTE key**
Use to temporarily mute the sound.
- 22 TUNING ◀◀/▶▶ keys**
Use to select the radio station.
- 23 Input source keys**
Use to operate the Kenwood DVD player.*
Use to select the input source.

Note:

- * For how to be able to use the keys to operate the Kenwood DVD player, see <Remote control operations for Kenwood DVD players> → [35].

Preparing the remote control

Loading batteries

1 Remove the cover.

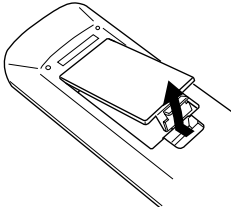

2 Insert batteries.

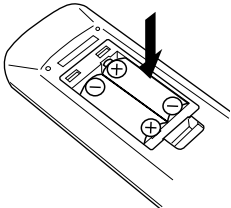

- Insert two (R03) batteries following the polarity indications.

3 Close the cover.

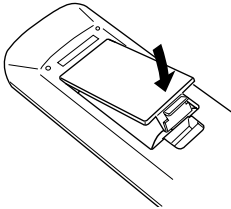

Operation

When the Standby indicator is lit, the power turns ON when you press [RECEIVER] on the remote control unit. When the power comes ON, press the key you want to operate.

Operating range (Approx.)

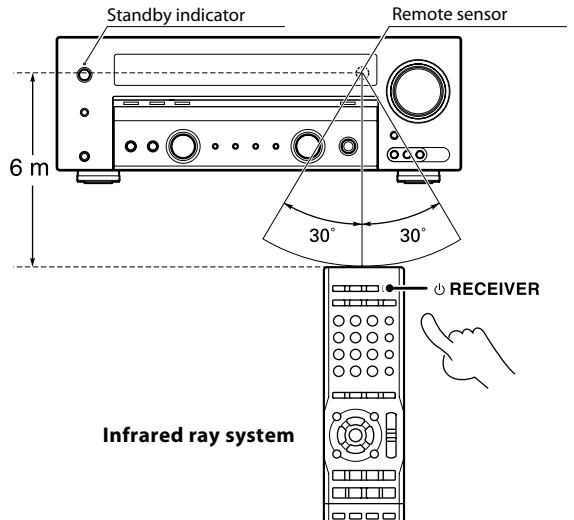

- When pressing more than one remote control key successively, press the keys securely by leaving an interval of 1 second or more between keys.

Notes:

1. The supplied batteries may have shorter lives than ordinary batteries due to use during operation checks.
2. When the remote-controllable distance gets shorter than before, replace both batteries with new ones.
3. Placing the remote sensor in direct sunlight, or in direct light from a high frequency fluorescent lamp may cause a malfunction. In such a case, change the location of the system installation to prevent malfunction.

Setting up the system

Make connections as shown in the following pages.

When connecting the related system components, be sure to refer to the instruction manuals supplied with the components you are connecting.

Do not connect the power cord to a wall outlet until all connections are completed.

Notes:

1. Be sure to insert all connection cords securely. If their connections are imperfect, the sound may not be produced or there will be noise interference.
2. Be sure to remove the power cord from the AC outlet before plugging or unplugging any connection cords. Plugging/unplugging connection cords without disconnecting the power cord can cause malfunctions and may damage the unit.

Analog connections

Audio connections are made using RCA pin cords. These cables transfer stereo audio signal in an "analog" form. This means the audio signal corresponds to the actual audio of two channels. These cables usually have 2 plugs at each end, red for the right channel and white for the left channel. These cables are usually packed together with the source unit, or are available at your local electronics retailer.

Microcomputer malfunction

If operation is not possible or an erroneous display appears, even though all connections have been made properly, reset the microcomputer by referring to <Troubleshooting>. → [36](#)

CAUTION

The power of this equipment will not be completely cut off from the wall outlet when the power switch is turned off. Install the equipment so that the wall outlet is easily accessible and, in case of emergency, immediately unplug the power cord from the wall outlet.

CAUTION

Be sure to adhere to the following, or proper ventilation will be blocked causing damage or fire hazard.

- Leave some space around the unit (from the largest outside dimension including projection) equal to or greater than, shown below.

Side panel : 10 cm

Back panel : 10 cm

- This unit is using the cooling fan. Do not place the unit onto a bed, a sofa, a carpet, or similar. Sucked-in dust can cause fire.

Speaker placement

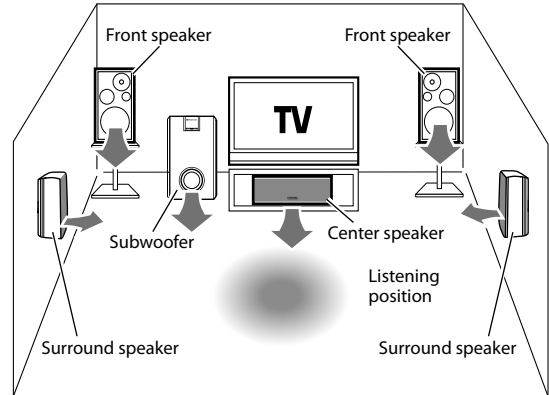

Front speakers:

Place the left and right speakers at each side of your TV. Angle the speakers towards the listening area to enhance the stereo effect.

Center speaker:

Place the center speaker on the center between the front left and right speakers. Tilt the speaker upward or down-ward so that it is directly facing the listening area.

Surround speakers:

Place the surround speakers as high as possible, either directly to the sides of the listening area or else slightly behind the listening area. Adjust the angles so that these speakers are facing directly towards the listeners.

Subwoofer:

Usually, place the subwoofer in the front center position in the listening room, near one of the front speakers. (Since the subwoofer has less directivity than other speakers, it can be placed almost in any position that can offer the best low frequency reproduction according to the room layout.)

Note:

- Although the ideal surround system consists of all the speakers listed above, if you don't have a center speaker or a subwoofer, you can divide those signals between the available speakers in the speaker settings steps to obtain the best possible surround reproduction from the speakers you have available.

Digital connections

The DIGITAL IN jacks can accept DTS, Dolby Digital, or PCM signals. Connect components capable of outputting DTS, Dolby Digital, or standard PCM (CD) format digital signals.

If you have connected any digital components to this unit, be sure to read the <Selecting the input mode> → [120](#) carefully.

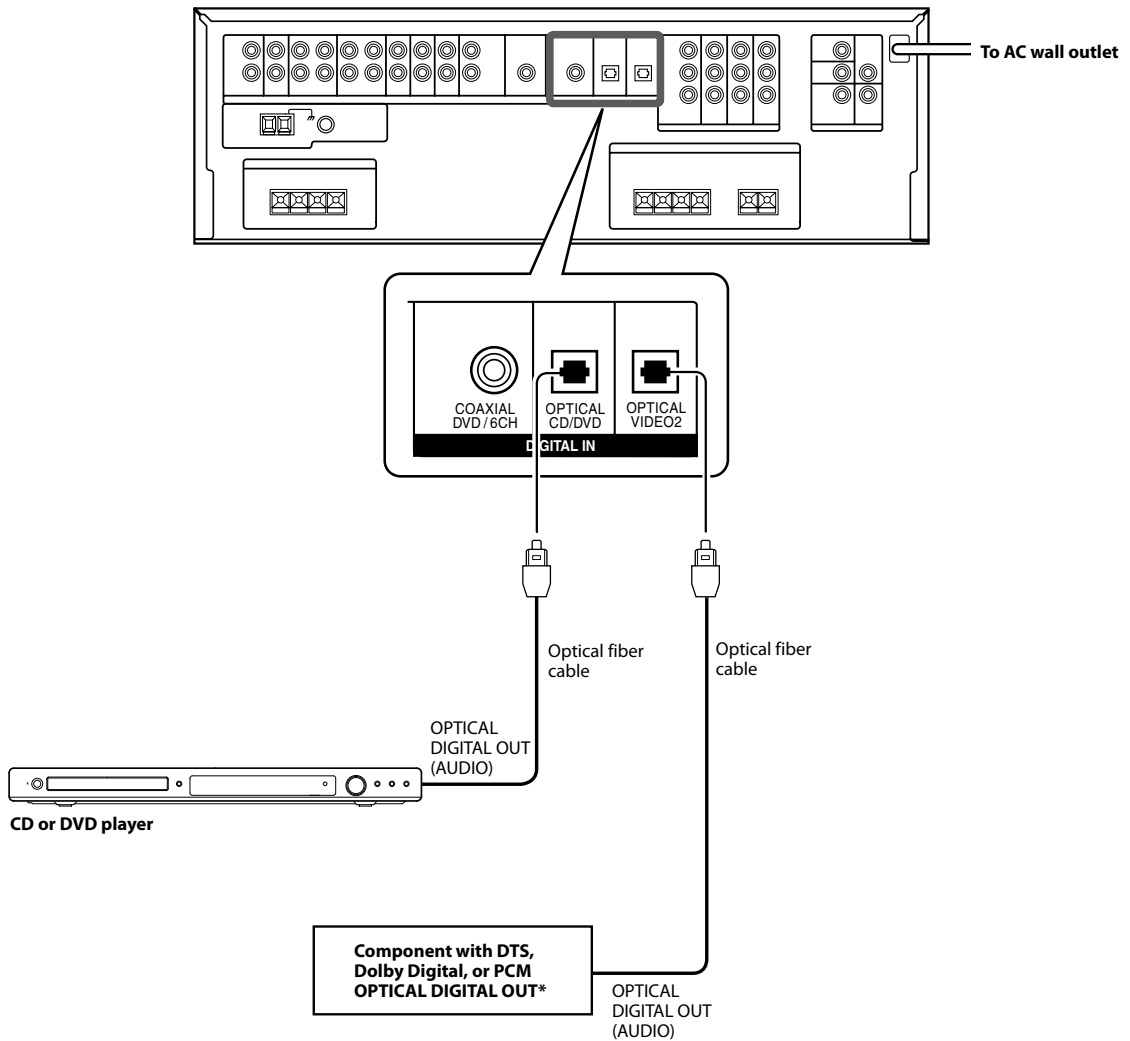

Note:

- * Connect the video signal and analog audio signals to the VIDEO 2 jacks. (<Connecting video components> → [121](#))

Connecting a DVD player (6-channel input)

If you have connected a DVD player to this unit with digital connection, be sure to read the <Selecting the input mode> → [20](#) carefully.

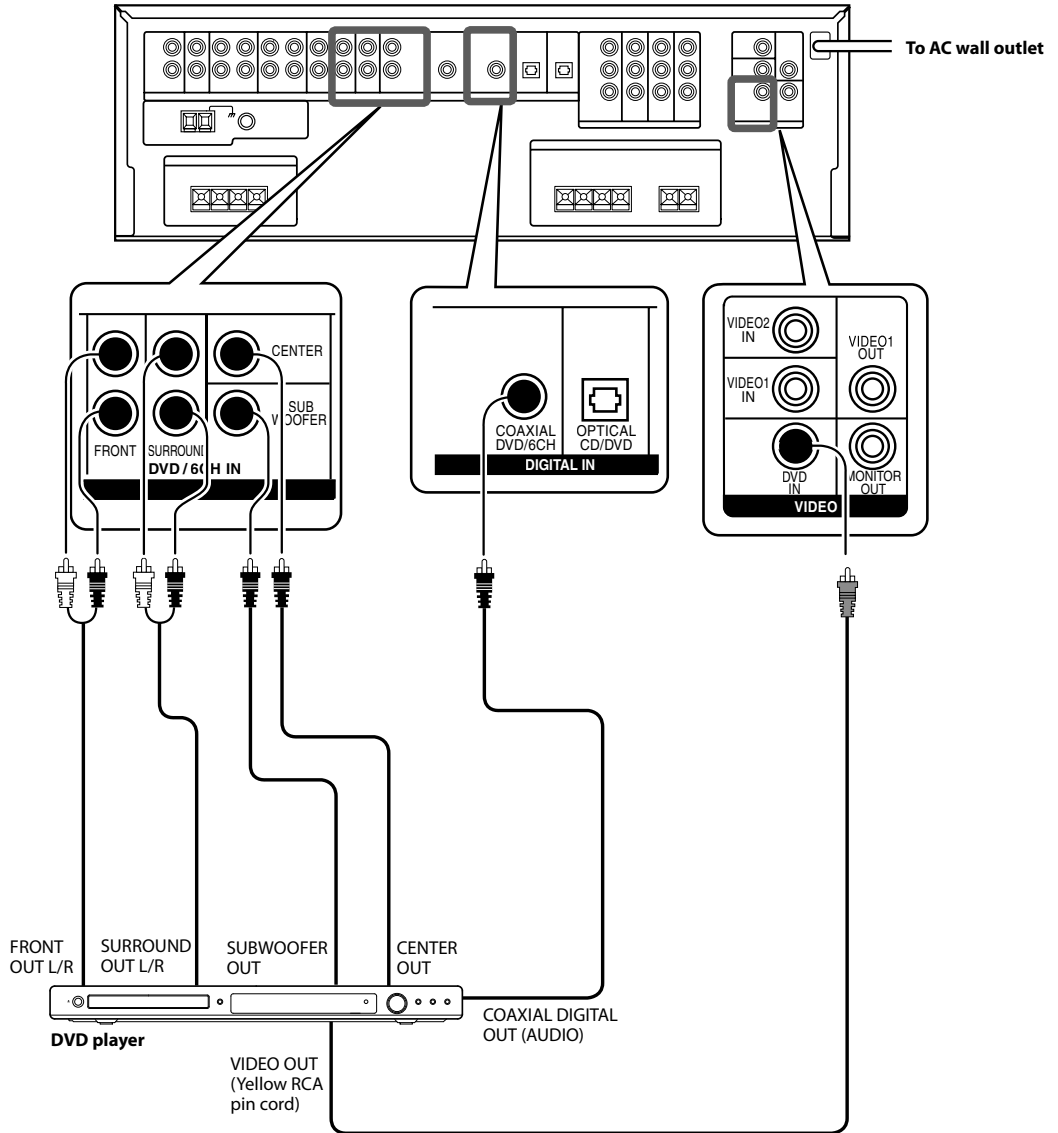

Note:
• For Australia only
If the DVD player has COMPONENT VIDEO OUT, COMPONENT VIDEO connection is possible. (<Connecting video components (COMPONENT VIDEO)> → [13](#))

Connecting audio components

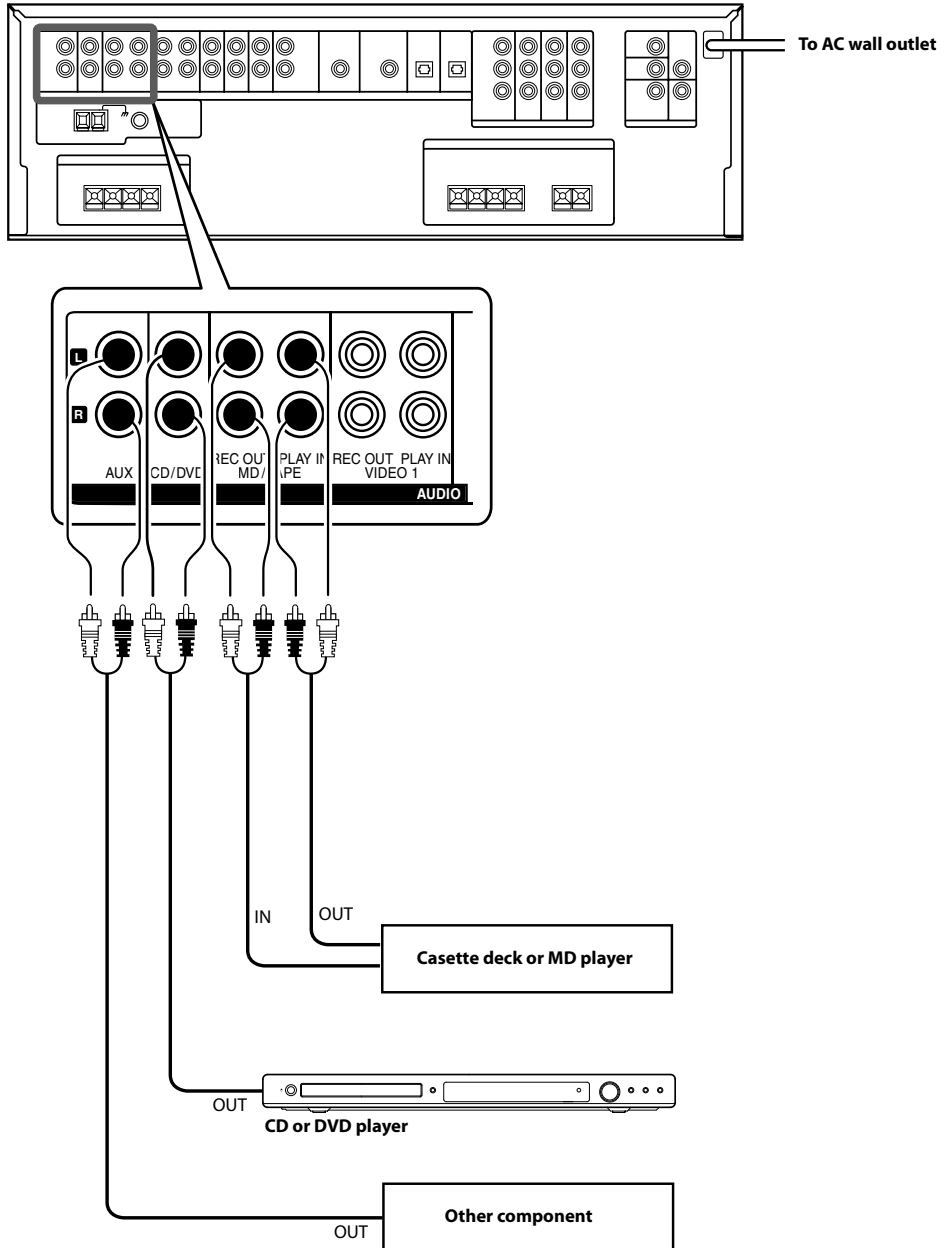

Connecting video components

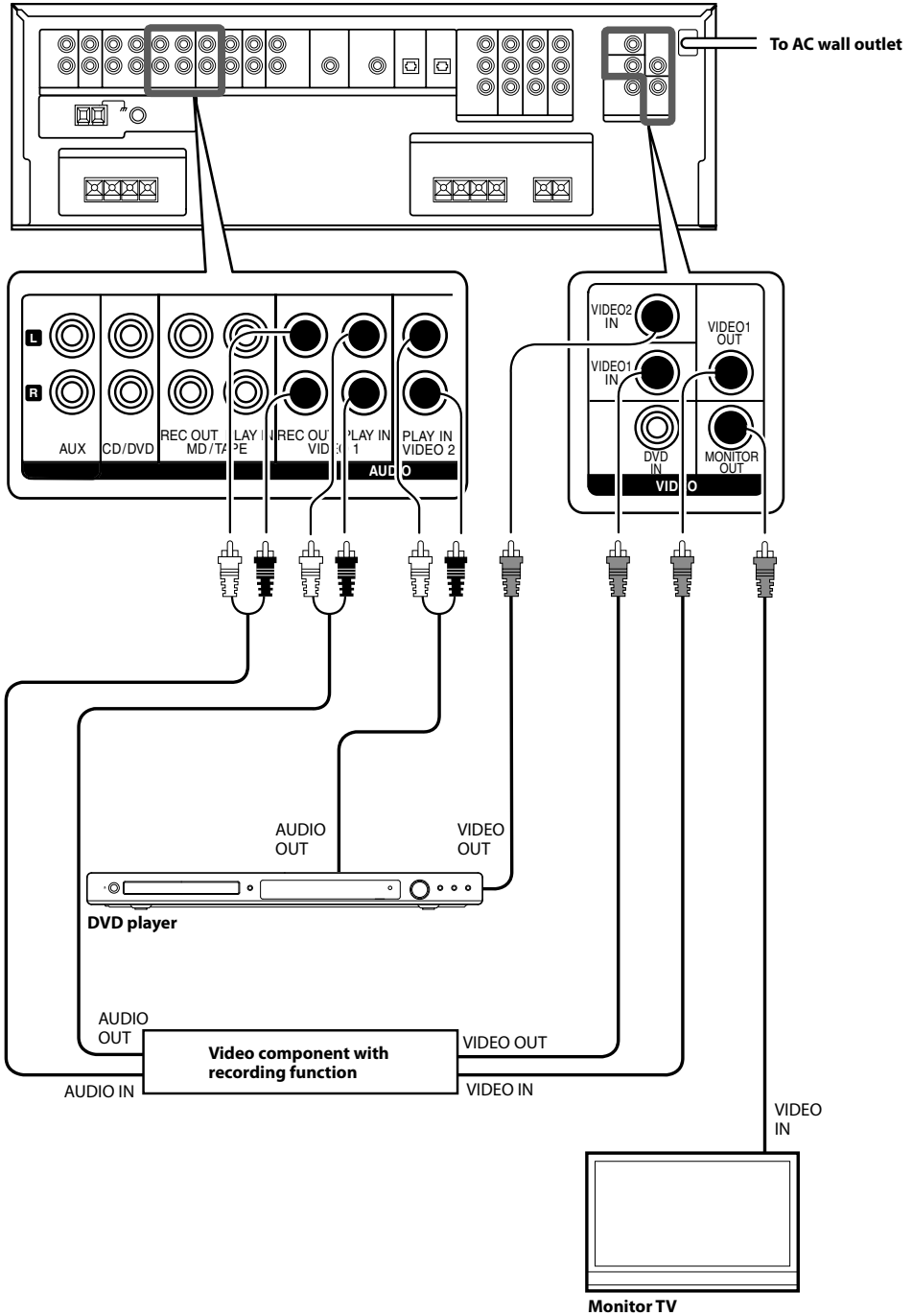

Note:

- A video component with digital audio outputs should be connected to the VIDEO 2 jacks.

Connecting video components (COMPONENT VIDEO) (For Australia)

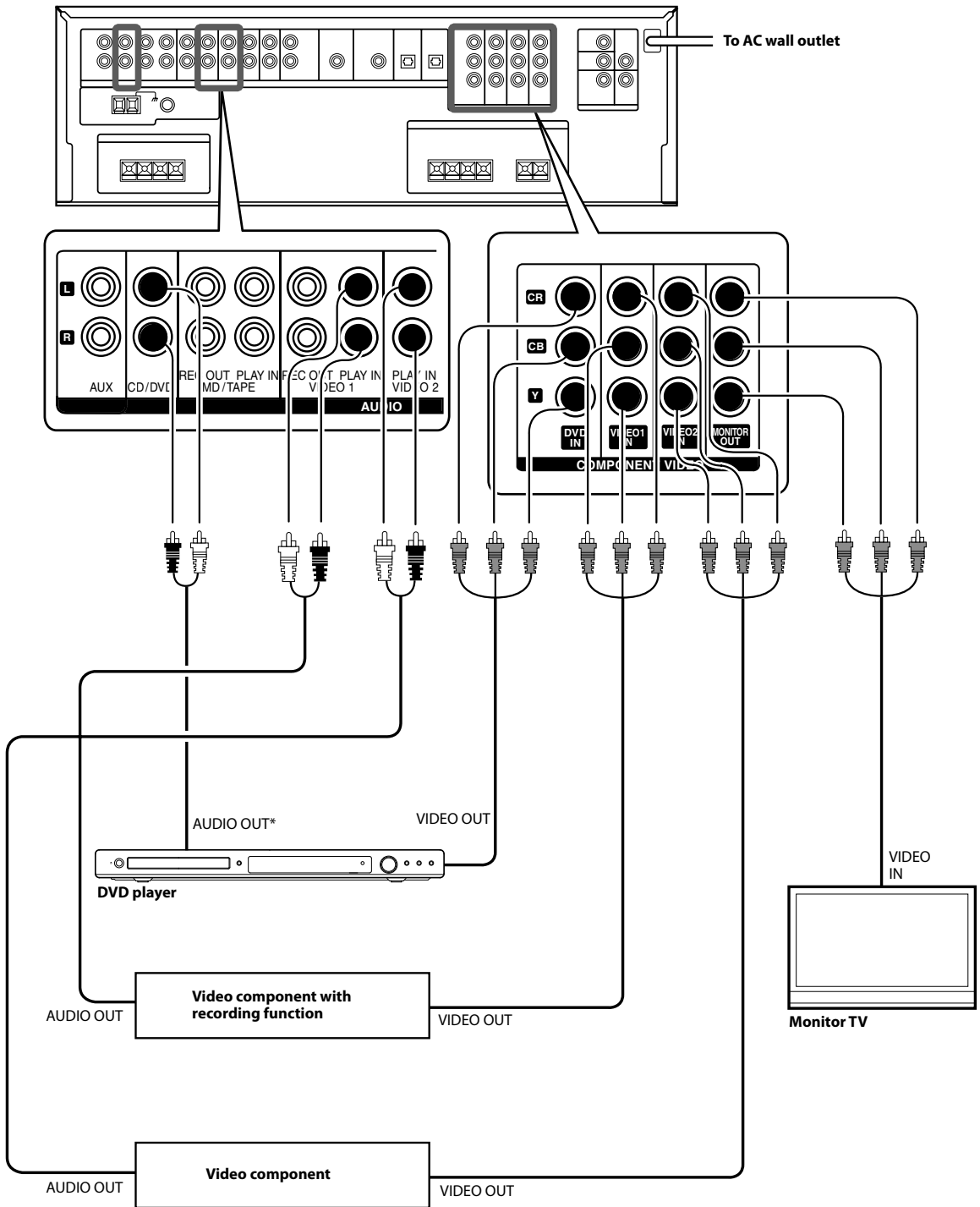

Notes:

- * If the DVD player has 6 channel output, connecting to DVD/6CH IN jacks is possible. (<Connecting a DVD player (6-channel input)> → [10](#))
- If some of the video equipment are connected to the COMPONENT jacks and the rest are connected to the normal (composite) VIDEO jacks, make sure to connect the TV to the MONITOR OUT jacks of both COMPONENT VIDEO and VIDEO.
- Depending on the type of TV, it may be necessary to switch the input of the TV according to the type of video input (COMPONENT input or COMPOSITE input). Refer to the instruction manual of your TV for more information.

Connecting the speakers

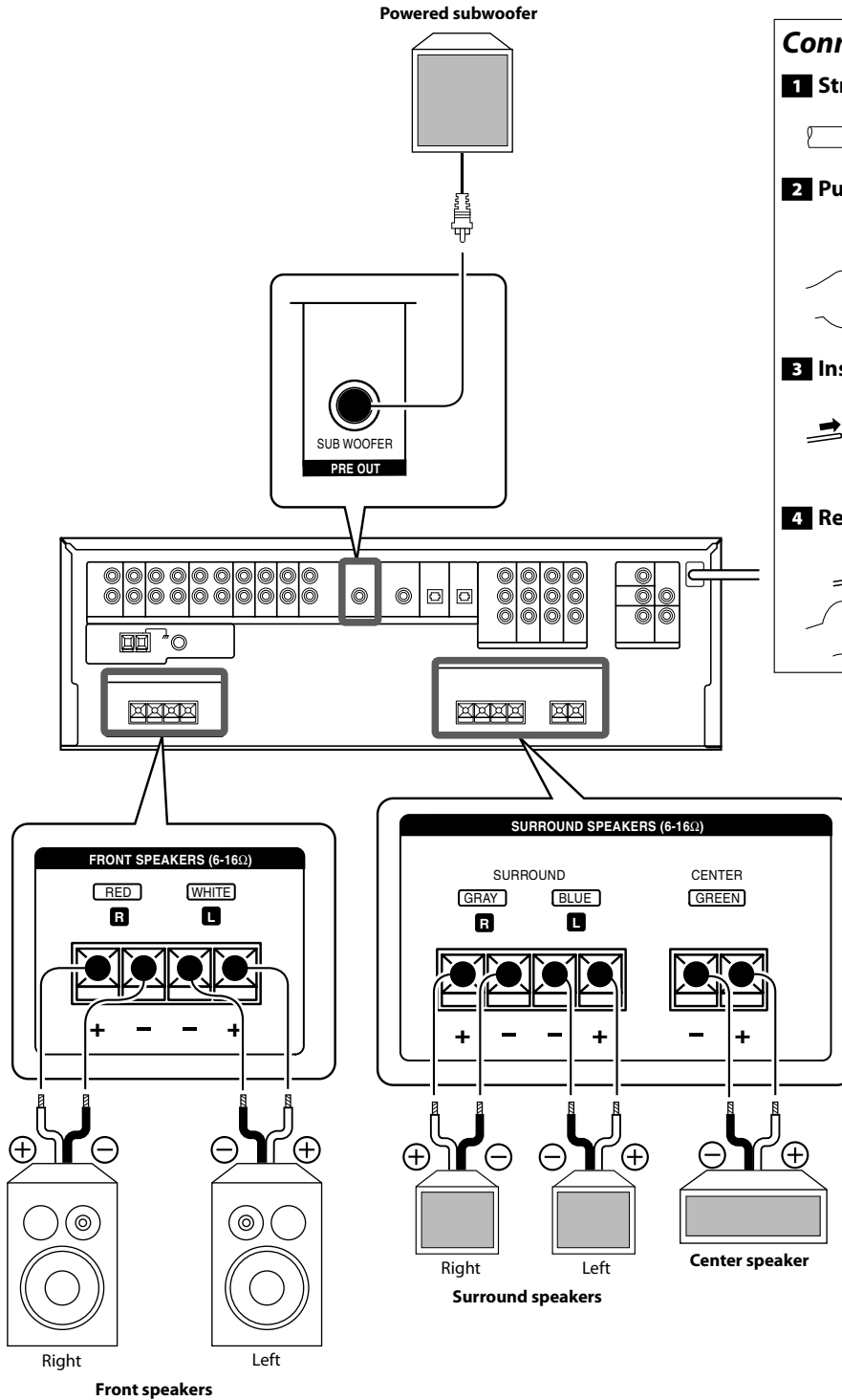

Connecting the terminals

1 Strip coating.



2 Push the lever.



3 Insert the cord.

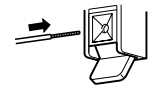

4 Return the lever.

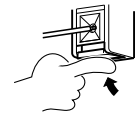

Notes:

- Speaker impedance
After confirming the speaker impedance indications printed on the rear panel of the receiver, connect speakers with matching impedance ratings. Using speakers with a rated impedance other than that indicated on the rear panel of the receiver could result in malfunctions or damage to the speakers or the receiver.
- Never short circuit the + and - speaker cords.
- If the left and right speakers are connected inversely or the speaker cords are connected with reversed polarity, the sound will be unnatural with ambiguous acoustic imaging. Be sure to connect the speakers correctly.

Connecting the antennas

The broadcast reception cannot be made unless the antennas are connected. Connect the antennas correctly as instructed below.

AM loop antenna

Place the supplied loop antenna as far as possible from the receiver, TV set, speaker cords and power cord. Adjust the direction for best reception.

1 Attach to the stand.



2 Push the lever.

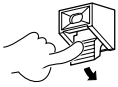

3 Insert the antenna cord.

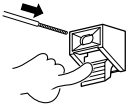

4 Release the lever.

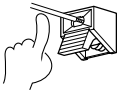

5 Place the antenna and adjust the direction.

FM indoor antenna

The supplied indoor antenna is for temporary use only. For stable signal reception we recommend using an outdoor antenna. Disconnect the indoor antenna when you connect one outdoors.

1 Insert the antenna cord.

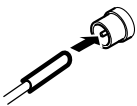

2 Fix the antenna on the wall.

FM outdoor antenna

Lead the 75Ω coaxial cable connected to the FM outdoor antenna into the room and connect it to the FM 75Ω terminal.

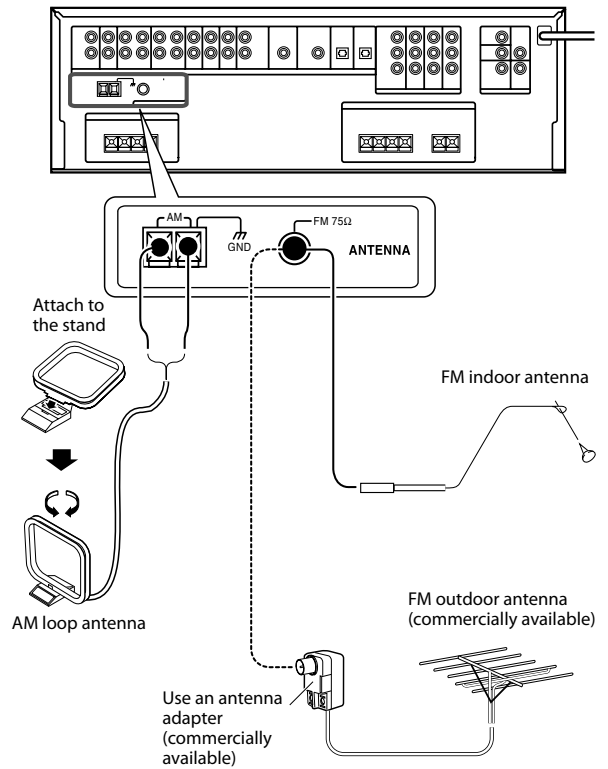

Connecting to the AV AUX jacks

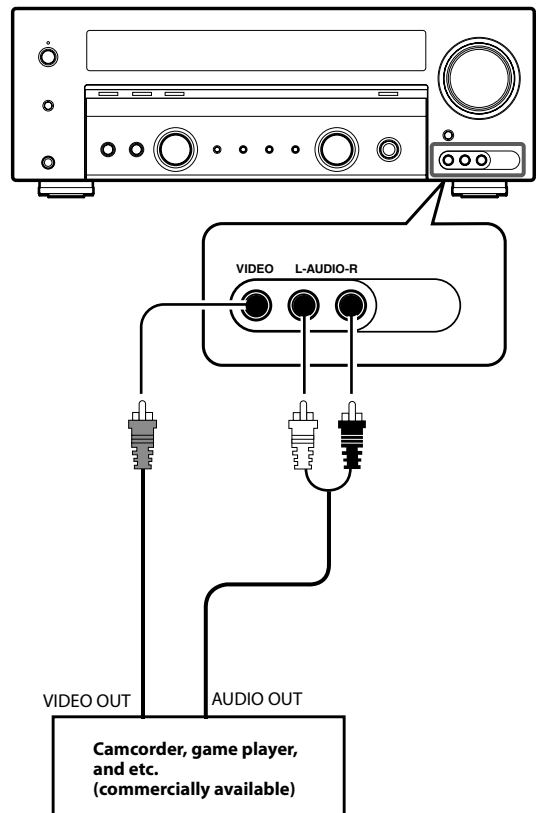

Speaker settings

Speaker setup (Easy Setup)

The speaker settings can be completed by simply selecting the room type and listening position. The audio will be corrected automatically according to the characteristics of the speaker system in use.

If more detailed speaker settings are required, use the procedure in <Speaker setting flow> → [17](#).

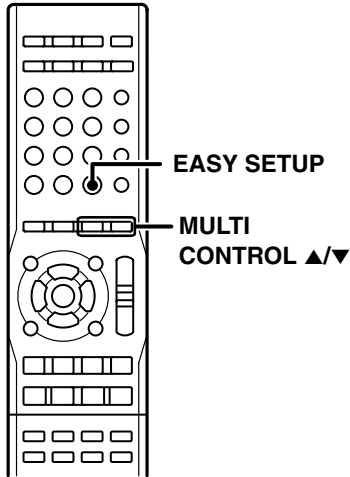

1 Press [EASY SETUP] to enter the easy setup mode.

2 Use [MULTI CONTROL ▲/▼] to select your room type.

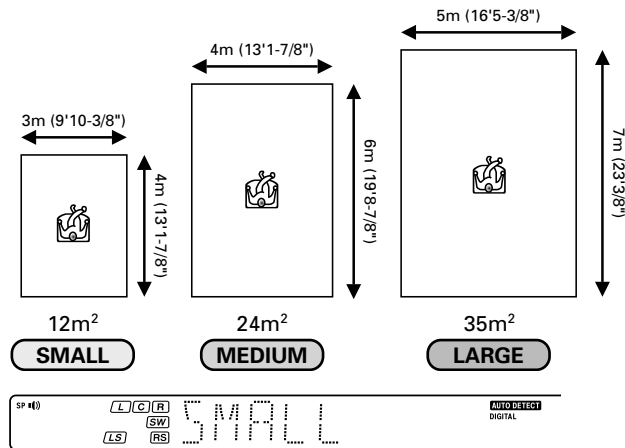

3 Press [EASY SETUP].

4 Use [MULTI CONTROL ▲/▼] to select your listening position.

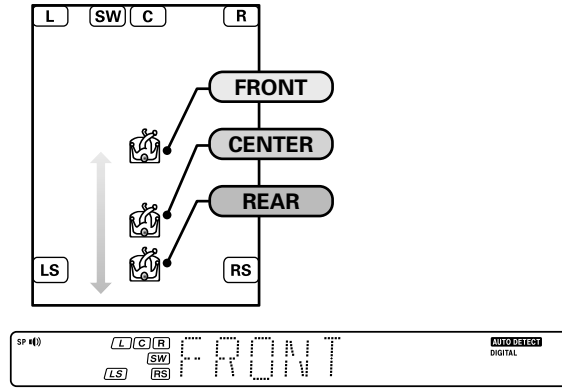

5 Press [EASY SETUP].

The speakers are set up as shown below.

- Subwoofer : ON
- Front speaker: Average size
- Center speaker: Average size
- Surround speaker: Average size
- Subwoofer re-mix* : ON

* The function for adding the bass of other channels to the subwoofer channel according to the speaker setup.

Note:

- Easy setup with may not be appropriate with certain speaker systems or listening environment. In this case, go through <Speaker setup ("SP SETUP")> → [18](#).

Speaker setting flow

The detailed settings below allow you to enjoy full performance of the receiver according to the environment of your listening room.

Speaker settings consist of 4 elements.

Speaker Setup ("SP SETUP") → 18

Select whether each speaker channel is used or, if used, its size.

The Easy Setup function also allows you to make speaker settings easier.

See <Speaker setup (Easy Setup)> → 16.



Test Tone ("TEST TONE") → 18

Select the output level from each speaker.



Distance ("DISTANCE") → 19

Select the distance between each speaker and the listening position.



Low Frequency Effects Level ("LFE LVL") → 19

Select the level of bass audio enhancement.

Low Frequency Effect channel delivers separate non-directional bass signals to the subwoofer for more dynamic deep bass sound effects.



Speaker settings completed!

Getting into the setup mode

The setup procedure is identical for all of the setting elements. Once you remember the following procedure, you can easily set up other setting elements.

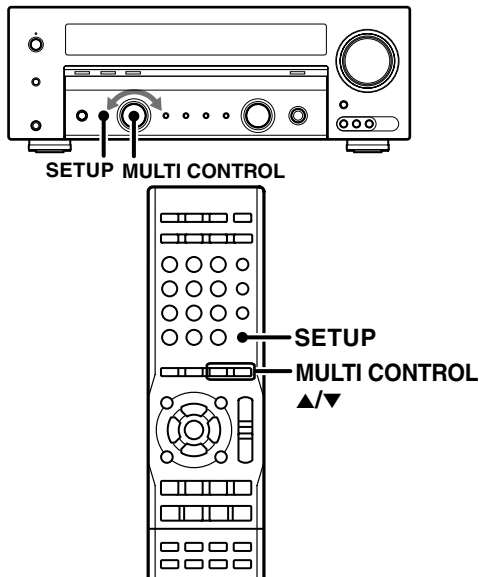

1 Press [SETUP] to enter the setup mode.

2 Use [MULTI CONTROL ▲/▼] to select the element to setup.

Display	Selection
"SP SETUP"	Speaker setup
"TEST TONE"	Test tone
"DISTANCE"	Distance
"LFE LVL"	Low frequency effects level
"EXIT"	Exit the setup mode.

3 Press [SETUP] to get into the setup mode of the selected element.

To exit the setup mode

Select "EXIT" in the step **2** and press [SETUP].

Speaker setup ("SP SETUP")

This sets up the speakers according to the speaker system in use. Speaker setup is required every time the speaker system is changed.

1 See <Getting into the setup mode> (→ 17) and select "SP SETUP".

2 Use [MULTI CONTROL ▲/▼] to select the subwoofer setting.

Speaker	Display	Selection
Subwoofer	"SUBW ON"	With Subwoofer
	"SUBW OFF"	Without Subwoofer

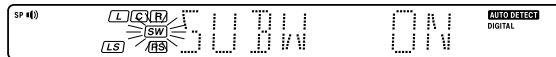

3 Press [SETUP].

4 Repeat steps **2** – **3** for the rest of the speaker setting.

Speaker	Display	Selection
Front speaker	"FRNT LRG"	Large size front speaker
	"FRNT NML"	Average size front speaker
Center speaker	"CNTR NML"	Average size center speaker
	"CNTR LRG"	Large size center speaker
Surround speaker	"CNTR OFF"	No center speaker is connected.
	"SURR NML"	Average size surround speaker
	"SURR LRG"	Large size surround speaker
Subwoofer re-mix*	"SURR OFF"	No surround speaker is connected.
	"RMX ON"	Subwoofer re-mix is on.
	"RMX OFF"	Subwoofer re-mix is off.

* The function for adding the bass of other channels to the subwoofer channel according to the speaker setup.

5 Go to the next setting, "TEST TONE".

• If you wish to exit the setup mode, see <To exit the setup mode> (→ 17).

Notes:

- When "SUBW OFF" is selected, the front speakers are automatically set to "FRNT LRG".
- For "FRNT LRG" selection, no sound will be heard from subwoofer even it is set to ON. However, if you select "RMX ON", you will be able to hear sound from the subwoofer.
- When in STEREO mode, the sound goes directly to front speakers.
- If "FRNT NML" is selected, "CNTR LRG" cannot be selected.
- If "CNTR NML" or "CNTR OFF" is selected, "SURR LRG" cannot be selected.

Adjusting the speaker level ("TEST TONE")

From your usual listening position, adjust the volume output of each speaker. The output level from each speaker should be the same.

1 See <Getting into the setup mode> (→ 17) and select "TEST TONE".

2 Use [MULTI CONTROL ▲/▼] to select either "AUTO" or "MANUAL".

Display	Selection
"AUTO"	The test tone is heard from the speakers one after another with 2 seconds each.
"MANUAL"	The test tone is heard from the speaker you have selected.

3 Press [SETUP].

4 Adjust the output level.

If you select "AUTO":

When you hear the test tone from the speaker which you wish to adjust, use [MULTI CONTROL ▲/▼] and adjust the volume of the test tone. When you finish adjusting, press [SETUP].

If you select "MANUAL":

Use [MULTI CONTROL ▲/▼] to adjust the volume of the test tone and press [SETUP]. You will hear the test tone from the next speaker.

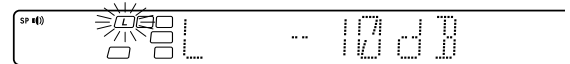

5 Go to the next setting, "DISTANCE".

• If you wish to exit the setup mode, see <To exit the setup mode> (→ 17).

Distance setting ("DISTANCE")

This sets the distance from each speaker to the listening position.

- 1 Measure the distance from the listening position to each speaker and jot down in the table below.

Speaker	Indicator	Distance from the listening position
Front speaker (left)	"L"	feet (meters)
Center speaker	"C"	feet (meters)
Front speaker (right)	"R"	feet (meters)
Surround speaker (right)	"RS"	feet (meters)
Surround speaker (left)	"LS"	feet (meters)
Subwoofer	"SW"	feet (meters)

- 2 See <Getting into the setup mode> (→ 17) and select "DISTANCE".

- 3 Use [MULTI CONTROL ▲/▼] to select the distance to the front speaker.

- Adjustment will start from front left speaker.

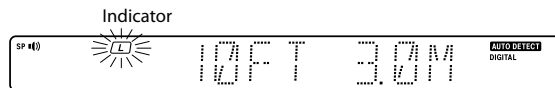

- 4 Press [SETUP].

- 5 Repeat steps 3 – 4 to input the distance for the rest of the speaker.

- 6 Go to the next setting, "LFE LVL".

- If you wish to exit the setup mode, see <To exit the setup mode> (→ 17).

Low frequency effects level ("LFE LVL")

Low frequency effect signal is used exclusively for giving the field effect of bass tone in the Dolby Digital and DTS signal.

- 1 See <Getting into the setup mode> (→ 17) and select "LFE LVL".

- 2 Use [MULTI CONTROL ▲/▼] to adjust the low frequency effect level.

- The level is adjusted from 0dB to -10dB in 1dB step decrements.

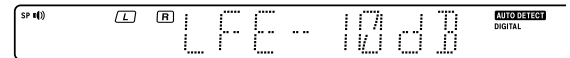

- 3 Press [SETUP].

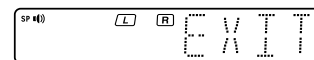

- The setup is complete when the "EXIT" indication appears.

- 4 Press [SETUP] to exit the setup mode.

Normal Playback

Preparing for playback

Some preparatory steps are needed before starting playback.

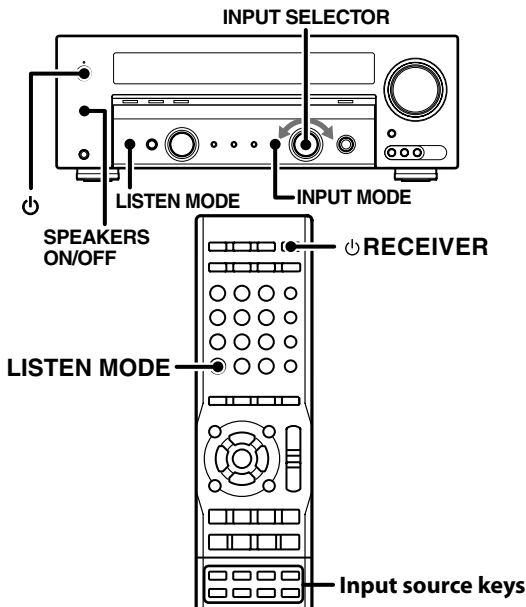

Turning on the power

- 1 Turn on the power to the related components.
- 2 Press [RECEIVER] to turn on the receiver unit.

Setting the speaker status (main unit only)

Press [SPEAKERS ON/OFF] to switch the speaker on or off.

The speaker indicator lights up when set to on.



Note:

- Set Speakers to OFF for stereo playback. When Speakers is set to ON again, the listen mode remains in stereo if the input signal is digital.

Selecting the input mode (main unit only)

If you have selected a component connected to the DIGITAL IN jacks (CD/DVD, VIDEO2 and DVD/6CH INPUT), make sure that the input mode setting is correct for the type of audio signal to be used.

- 1 Use [INPUT SELECTOR] to select "CD/DVD", "VIDEO2", or "DVD/6CH".

- 2 Press [INPUT MODE].

Each press switches the setting as follows:

Display	Setting	Input signal
"F-AUTO"*1	Full Auto	Digital input or Analog input
"D-MANUAL"	Digital Manual	Digital input
"6CH INPT"*2*3	6ch input	DVD/6CH input
"ANALOG"*3	Analog input	Analog input

*1 Factory setting.

*2 "6CH INPT" setting can be switched only when the input selector is set to "DVD/6CH".

*3 This cannot be selected when in DTS play mode.

Full Auto ("F-AUTO"):

The unit detects the digital or analog input signal automatically. The unit selects the input mode and listen mode automatically during playback to match the type of input signal (Dolby Digital, DTS or PCM) and the speaker setting. Normally use Full Auto.

In this mode, "AUTO DETECT" indicator lights up.

"DIGITAL" indicator also lights up when digital input signal comes in.

"AUTO DETECT" and "DIGITAL" indicators

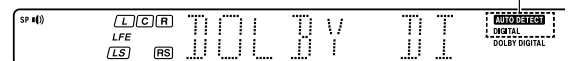

Digital Manual ("D-MANUAL"):

Some discs produce sound skipping even when "F-AUTO" is set. Select "D-MANUAL" with such a disc. Digital Manual accelerates the input signal processing by fixing the listen mode and therefore minimizes sound skipping during disc playback.

If audio reproduction stops in the middle due to change in the input signal, press [LISTEN MODE].

6ch input ("6CH INPT"):

Select this setting to play the DVD player connected to DVD/6CH IN jacks.

Analog input ("ANALOG"):

Select this setting to play analog signals from a cassette deck, VCR, or record player.

Note:

- If [INPUT MODE] is pressed too quickly, sound may not be produced. Press [INPUT MODE] again.

Listening to a source component

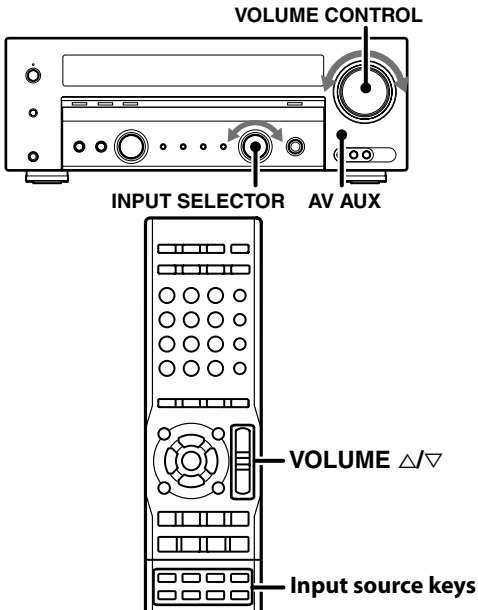

1 Select the source you want to listen to.

When using the remote control unit:
Use the Input source keys to select a source.

The following input source keys are prepared on the remote control unit:

- Tuner (FM/AM broadcast reception)
- "CD/DVD"
- "MD/TAPE"
- "VIDEO1"
- "VIDEO2"
- "DVD/6CH"
- "AUX"
- "AV AUX"

When using the main unit:
Use [INPUT SELECTOR] to select a source.

The input sources change as shown below with [INPUT SELECTOR]:

- ① Tuner (FM/AM broadcast reception)
 - ② "CD/DVD"
 - ③ "MD/TAPE"
 - ④ "VIDEO1"
 - ⑤ "VIDEO2"
 - ⑥ "DVD/6CH"
 - ⑦ "AUX"
- "AV AUX" can be selected with [AV AUX].

2 Start playback from the selected source.

3 Use [VOLUME Δ/∇] to adjust the volume.

Listening to music with PURE AUDIO MODE

The PURE AUDIO MODE allows you to enjoy music sources in high-quality stereo.

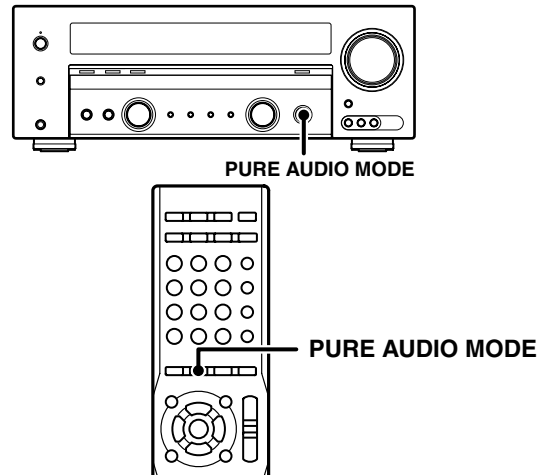

1 Select the music source you want to listen to.

2 Start playback from the selected source.

3 Press [PURE AUDIO MODE].

- While in PURE AUDIO MODE, the listen mode is set to stereo.
- The display will be turned off and PURE AUDIO MODE indicator lights up.

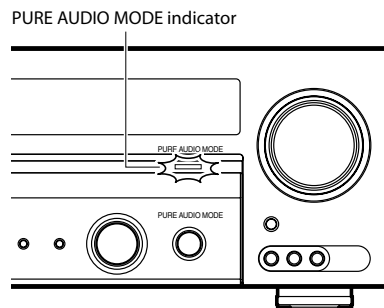

To cancel

Press [PURE AUDIO MODE] again.

- PURE AUDIO MODE is also cancelled when listen mode is changed. See <Surround play>. → 25

Notes:

- When the input mode is "6CH INPT", the listen mode does not change. (<Selecting the input mode> → 20)
- During PURE AUDIO MODE, no video signal is output.
- When the PURE AUDIO MODE is canceled, the listen mode remains in stereo if the input signal is digital.

Adjusting the sound

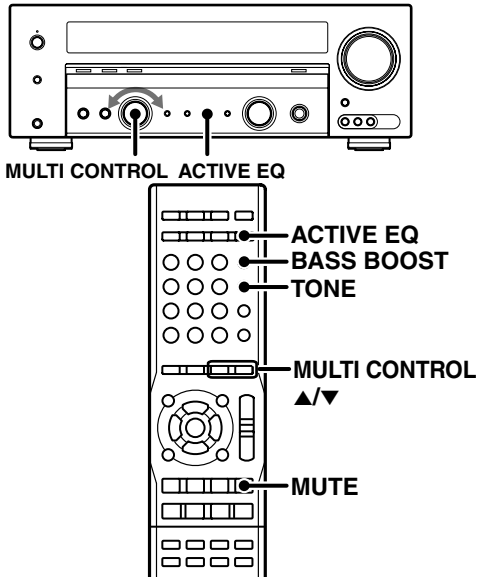

Adjusting the Tone (remote control only)

You can adjust the sound quality when this unit is in the PCM stereo and analog stereo mode.

- 1 Press [TONE] to select the Tone mode.
- 2 Use [MULTI CONTROL ▲/▼] to select "TONE ON" or "TONE OFF".

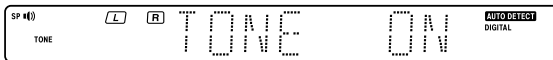

- 3 When in "TONE ON" selection, press [TONE] for the following displays.

Display	Setting	Range
"BASS"	Adjusts low frequency range.	-10 – +10 (in 2 step)
"TREB"	Adjusts high frequency range.	-10 – +10 (in 2 step)

- 4 Use [MULTI CONTROL ▲/▼] to adjust the sound quality.



- When the ACTIVE EQ mode is set to ON, set it to OFF and then control the TONE setting.

- 5 Press [TONE].

One-touch low frequency emphasis (Bass Boost) (remote control only)

You can adjust the sound quality when this unit is in the PCM stereo and analog stereo modes.

Press [BASS BOOST].

- Press the key once to select the maximum (+10) low frequency emphasis setting.
- TONE will automatically be turned ON.
- This key does not function when this unit is in the sound quality or ambience effects adjustment mode.
- When the ACTIVE EQ mode is set to ON, set it to OFF and then control the BASS BOOST setting.

To cancel

Press [BASS BOOST] again.

Muting the sound (remote control only)

Press [MUTE] to mute the sound of the speakers.

"MUTE" indicator blinks.

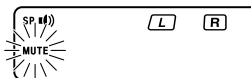

To cancel

Press [MUTE] again so that the "MUTE" indicator goes off.

- MUTE can also be deactivated by adjusting volume.

ACTIVE EQ mode

You can enjoy a more impressive sound effect when ACTIVE EQ is turned ON during Dolby Digital and DTS playback and, when in PCM and analog stereo mode.

Press [ACTIVE EQ] for the following selections;

Display	Setting
"ACTIVE EQ MUSIC"	Effective when listening to music.
"ACTIVE EQ CINEMA"	Effective when watching a movie.
"ACTIVE EQ GAME"	Effective when playing a game.
"ACTIVE EQ OFF"	Active EQ function is off.

- ACTIVE EQ function will not be available when REC MODE, AUTO TUNING or PRESET MEMORY is ON and during 96kHz LPCM playback.

ACTIVE EQ indicator lights up.

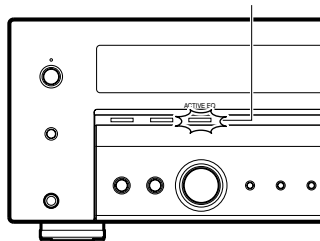

Ambience effects

Surround modes

This unit is equipped with listen modes that allow you to enjoy an enhanced sonic ambience with a variety of video sources. In order to obtain the optimum effect from the surround modes, make sure to input the proper speaker settings beforehand. See <Speaker settings> → [16].

The below speaker placements are for 5.1 channel surround sound system which are;

- **Dolby Digital**
- **Dolby Pro Logic II**
- **DTS**
- **DSP mode**
- **DVD 6-channel**

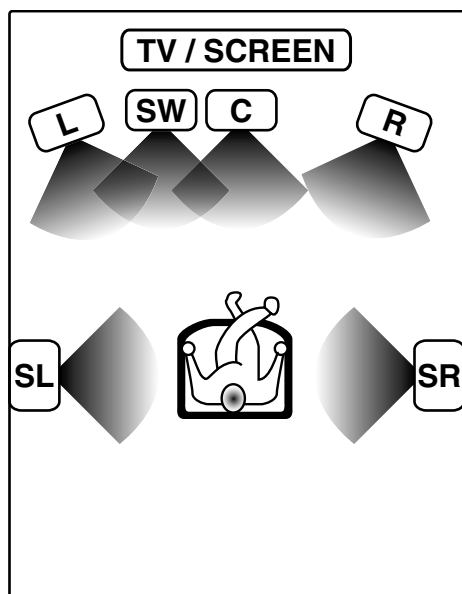

- L : Front Left speaker
- SW : Subwoofer
- C : Center speaker
- R : Front Right speaker
- LS : Surround Left speaker
- RS : Surround Right speaker

Dolby Digital

Dolby Digital is a highly sophisticated and versatile audio encoding/decoding technology. Dolby Digital technology can transmit mono, stereo (two-channel), or up to 5.1-channel surround sound (discrete* multichannel audio). In 5.1-channel surround sound, the three front channels (Left/Center/Right) deliver crisp, clean dialogue and accurate placement of on-screen sounds, while twin surround channels (Left Surround/Right Surround) wrap around the audience and immerse them in the action. The LFE (Low-Frequency Effects) channel delivers real impact for explosions and other effects that can, literally, be felt as well as heard. The superior coding efficiency of Dolby Digital and its ability to deliver high-quality discrete multichannel audio without compromising video quality has made it the designated audio standard for DVD worldwide.

* The sound information contained in each of the six available channels is distinct and independent. These six channels are described as a "5.1-channel" system, because there are five full-bandwidth channels with 3 Hz to 20 kHz frequency range for Front Left and Right, Center, and Surround, plus one "Low Frequency Effects" (LFE) subwoofer channel devoted to frequencies from 3 to 120 Hz.

Dolby Pro Logic II

Dolby® Pro Logic® II technology processes any high quality stereo (two-channel) movie and music audio into five playback channels of full-bandwidth surround sound. A matrix surround decoding technology, Dolby Pro Logic II detects the directional cues that occur naturally in stereo content and uses these elements to create a five-channel surround sound playback experience. Dolby Pro Logic II is fully compatible with all Dolby Pro Logic technologies. It provides optimal audio for playback in a 5.1-channel home theater system for the thousands of videocassettes and TV programs encoded in four-channel Dolby Surround (the encoding counterpart to Dolby Pro Logic's decoding technology). (Dolby Pro Logic II surround Movie mode) Dolby Pro Logic II also enables video game consoles to encode five-channel surround sound information into a stereo signal with virtually no impact on the console's CPU, which means all this extra audio won't slow your game down. (Dolby Pro Logic II surround Game mode) Dolby Pro Logic II can bring new life to your CD collection. Play your music through your home theater system, and you'll hear seamless, natural sound with new depth and detail. It's almost like hearing a newly remastered CD. (Dolby Pro Logic II surround Music mode)

Manufactured under license from Dolby Laboratories. Dolby, Pro Logic, and the double-D symbol are trademarks of Dolby Laboratories.

Manufactured under license under U.S. Patent #'s: 5,451,942; 5,956,674; 5,974,380; 5,978,762; 6,487,535 & other U.S. and worldwide patents issued & pending. DTS and DTS Digital Surround are registered trademarks and the DTS logos and Symbol are trademarks of DTS, Inc. © 1996-2007 DTS, Inc. All Rights Reserved.

DTS

DTS Digital Surround is the standard for providing 5.1 channels of discrete digital audio in consumer electronics products and software content.

DTS can contain a larger volume of data than Dolby Digital, and can reproduce high quality surround sound. They are the same as the Dolby Digital 5.1 channels, but it is a format that lowered the audio compression rate when recording digitally. Because of that, rich sound with high S/N can be reproduced. Moreover, an exact, magnificent surround sound with wide dynamic range and excelling in separation is a feature of DTS.

DTS has a ".1" or LFE channel.

The indication "LFE" appears in the display when a signal is being input for this channel.

DSP mode

The DSP mode lets you add the atmosphere of a live concert or hall to almost any type of program source. These modes are particularly effective when used with stereo program sources, like CD, television, and FM radio. You might enjoy trying the ARENA, JAZZ CLUB, THEATER, STADIUM or DISCO mode the next time you watch a concert or sporting event!

What's DSP?

DSP stands for Digital Signal Processor.

The way a sound is heard in an actual environment depends on a variety of different factors. One of the most important is reverberation (the act of decaying elements of sound echoing in various places).

The DSP modes produce the feeling of presence by using the DSP to create reverberation, without spoiling the sound quality of the original signal.

DVD 6-channel mode

Using a DVD player or the like equipped with six (5.1) output channels and this unit, you can enjoy multi-channel encoded DVD source material in all its splendor. Since the source signals are digital and each channel is input independently, the resulting sound quality, sense of spaciousness, and dynamic range are superb.

The indication "6CH INPUT" appears in the display during DVD 6-channel mode selection.

Note:

- LFE = Low Frequency Effects.
This channel delivers separate non-directional bass signals to the subwoofer for more dynamic deep bass sound effects.

About indicators for surround mode

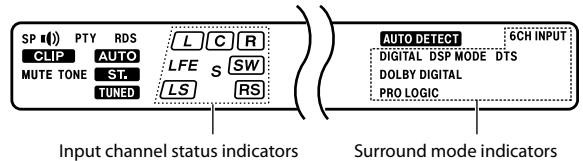

Input channel status indicator

It shows the channels contained in the input signal. Note that the input channel indicator does not show the channel of the listen mode.

The "LFE" indicator lights when the low frequency effects level is adjusted. See <Low frequency effects level ("LFE LVL")> (→ 19).

The "S" indicator lights when the surround component consists of a single channel.

Surround mode indicator

The indicator for the selected listen mode lights up. "DIGITAL" also lights when the input signal is digital.

Surround play

Select the listen mode according to the source being played back.

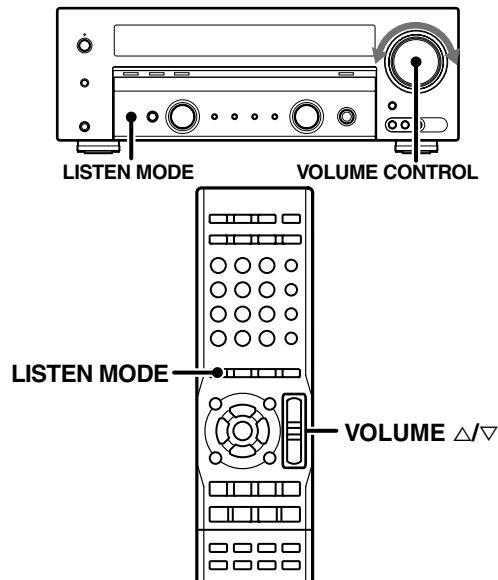

Preparations

- Turn on the related components.
- Complete <Speaker settings>. → [16]
- Select the source you wish to play back with surround sound.
- Select the input mode (analog or digital) for the source you wish to playback. (Noise may be produced when a DTS source is played by selecting the analog input.) → [20]

1 Start playing the video software.

2 Press [LISTEN MODE] to select the listen mode.

The listen mode settings are stored separately for each input. If the input mode is set to full auto ("AUTO DETECT" lights), the unit selects the optimal listen mode automatically based on the type of input signal and the speaker settings.

Each press of [LISTEN MODE] switches the setting as listed.

When the Dolby Digital signal is input:

Display	Listen mode	Indicator
"DOLBY DIGITAL"	Dolby Digital surround mode	"DOLBY DIGITAL"
"PL II MOVIE"*	Pro Logic II surround Movie mode	"DOLBY DIGITAL" and "PRO LOGIC"
"PL II MUSIC"*	Pro Logic II surround Music mode	"DOLBY DIGITAL" and "PRO LOGIC"
"PL II GAME"*	Pro Logic II surround Game mode	"DOLBY DIGITAL" and "PRO LOGIC"
"PRO LOGIC"*	Pro Logic mode	"DOLBY DIGITAL" and "PRO LOGIC"
"STEREO"	Stereo mode	"DOLBY DIGITAL"

* Available when the input signal has only 2 channels.

When "Dolby Digital" is selected:

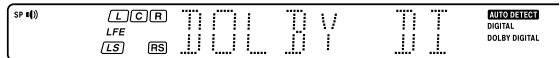

"DOLBY DIGITAL" will scroll from right to left.

When the DTS signal is input:

Display	Listen mode	Indicator
"DTS"	DTS 5.1 channel surround mode	"DTS"
"STEREO"	Stereo mode	"DTS"

When "DTS" is selected:

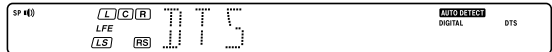

When the analog signal or digital signal (except for Dolby Digital or DTS signal) is input:

Display	Listen mode	Indicator
"PL II MOVIE"	Pro Logic II surround Movie mode	"PRO LOGIC"
"PL II MUSIC"	Pro Logic II surround Music mode	"PRO LOGIC"
"PL II GAME"	Pro Logic II surround Game mode	"PRO LOGIC"
"PRO LOGIC"	Pro Logic mode	"PRO LOGIC"
"ARENA"	DSP surround ARENA mode	"DSP MODE"
"JAZZ CLUB"	DSP surround JAZZ CLUB mode	"DSP MODE"
"THEATER"	DSP surround THEATER mode	"DSP MODE"
"STADIUM"	DSP surround STADIUM mode	"DSP MODE"
"DISCO"	DSP surround DISCO mode	"DSP MODE"
"STEREO"	Stereo mode	--

3 Adjust the volume.

Notes:

- Depending on the type of the signal or speaker setting, some listen modes cannot be selected.
- When playback is started, the sound may be cut or interrupted before the input source is confirmed as Dolby Digital.
- To enjoy Dolby Digital surround (as well as all the other listen modes) from a single component, be sure to use a Dolby Digital compatible source component.
- Dolby Digital or DTS signal having more channels than the maximum number of playback channels available using this unit's current settings is input, downmixing is performed to match the number of available channels.

96kHz LPCM playback

This unit is compatible with the 96kHz LPCM playback. To play a 96kHz DVD, set the listen mode to "STEREO".

- In "F-AUTO" input mode, the listen mode will automatically be STEREO.
- When in "D-MANUAL" input mode (listen mode is not STEREO), "FS 96kHz" will appear in the display and no sound can be heard from the speakers. Press [LISTEN MODE] (the listen mode changes to the "STEREO" mode) to output sound from the speakers.

DVD 6-channel playback

Using a DVD player or the like equipped with six (5.1) output channels and this unit, you can enjoy surround sound playback. Connecting a DVD player which can decode the surround signal itself is also acceptable.

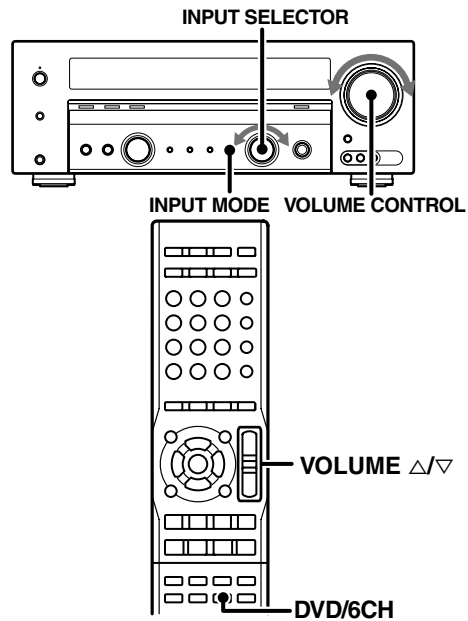

Preparations

- Connect your DVD player to the DVD/6CH INPUT jacks of this unit.
- Turn on all other components that will be used.
- Complete <Speaker settings>.

1 Select "DVD/6CH" as the input source.

2 Press [INPUT MODE] to select "6CH INPT".

3 Start playback of a DVD disc.

4 Adjust the volume.

Notes:

- It is not possible to adjust the speaker level or sound effect ([SETUP], [SOUND], [LISTEN MODE], [ACTIVE EQ] and [TONE] will not be functional) of the channels separately when this unit is in the 6CH INPUT mode. Adjust the speaker level with the controls of the DVD player. Refer to the Instruction manual of the DVD players for the detailed operating instructions.
- For the powered subwoofer, you can adjust the volume of the subwoofer using the subwoofer's own volume control.

Listening to radio broadcasts

This unit can store up to 40 stations in the memory and recall them by one-touch operation.
Radio stations can be classified into RDS (Radio Data System) stations and other stations. To listen to or store RDS stations in the preset memory see <Using RDS (Radio Data System)>.

Tuning (non-RDS) radio stations

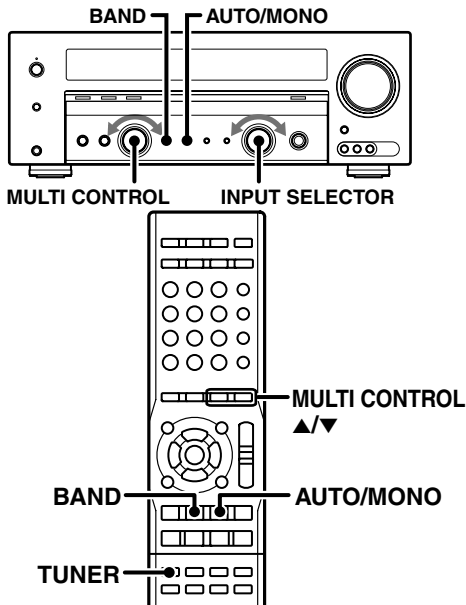

- 1 Use [TUNER] to select the tuner.
- 2 Use [BAND] to select the desired broadcast band.
Each press switches the band as follows:
 - ① FM
 - ② AM

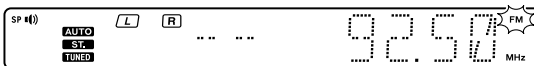

- 3 Use [AUTO/MONO] to select the desired tuning method.

Each press switches the tuning method as follows:

Selection	Operation	Indicator
Auto tuning	The next station is tuned automatically.	"AUTO" lit
Manual tuning	Select a station manually.	"AUTO" not lit

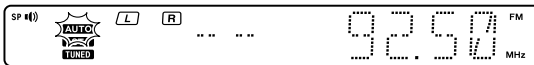

- Normally, set to "AUTO" (auto tuning). If the radio waves are weak and there is a lot of interference, switch to manual tuning. (With manual tuning, stereo broadcasts will be received in monaural.)

- 4 Use [MULTI CONTROL ▲/▼] or [TUNING ◀◀/▶▶] to select the station.

"ST:" lights when a broadcast is being received in stereo.

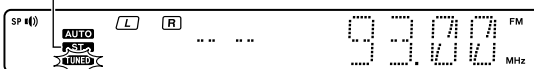

Using RDS (Radio Data System)

RDS is a system that transmits useful information (in the form of digital data) for FM broadcasts along with the broadcast signal. Tuners and receivers designed for RDS reception can extract the information from the broadcast signal for use with various functions, such as automatic display of the station name.

Before using a function utilizing the RDS, be sure to perform the RDS Auto Memory operation by referring to the description in <RDS Auto Memory>. (→ [28])

RDS functions:

RDS AUTO MEMORY function

Automatically selects and stores up to 40 RDS stations in the preset memory.
If fewer than 40 RDS stations have been stored in the preset memory, regular FM stations will be stored in the remaining places.

PS (Program Service) Name Display

Automatically displays the station name transmitted by the RDS station.

PTY (Program TYPe) identification Search

Automatically tunes to a station that is currently broadcasting the specified program type (genre).

RT (Radio Text) function

Displays the radio text data transmitted by some RDS stations when you press [RDS DISP.]. There is "NO RT" or "RT ----" display if no text data is transmitted.
The "RDS" indicator lights up when an RDS broadcast (signal) is received.

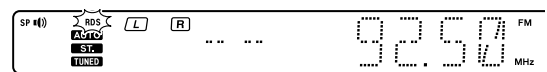

Note:

- Some functions and function names may differ for certain countries and areas.

RDS Auto Memory

This function automatically stores up to 40 RDS stations in the preset memory. In order to use the PTY function, the RDS stations must be stored in the preset memory using the RDS AUTO MEMORY function.

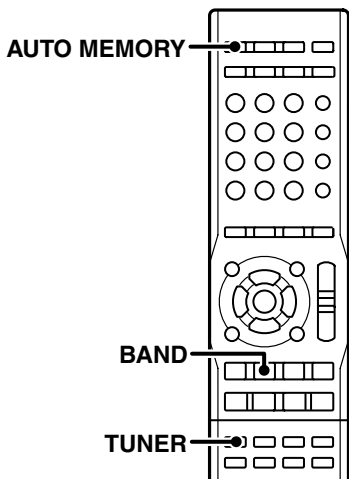

- 1** Use [TUNER] to select the tuner.
- 2** Use [BAND] to set the broadcast band to "FM".
- 3** Press [AUTO MEMORY].

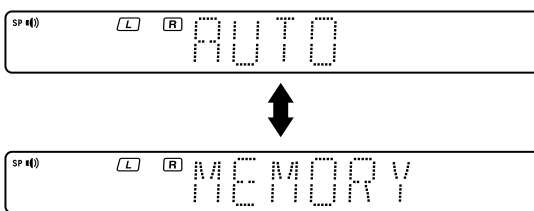

- After a few minutes, up to 40 RDS stations are preset in order from channel "01".
- Stations already stored in the preset memory may be replaced by RDS stations. (i.e., If the RDS AUTO MEMORY function detects 15 RDS stations, the stations currently preset at numbers 01–15 will be replaced by the RDS stations.)

Presetting radio stations manually

The RDS auto memory function assigns preset numbers to RDS stations starting from preset number "1". Therefore, be sure to execute the RDS auto memory function before using the following operations to manually store AM stations and other FM stations, and RDS stations.
See <RDS Auto Memory>.

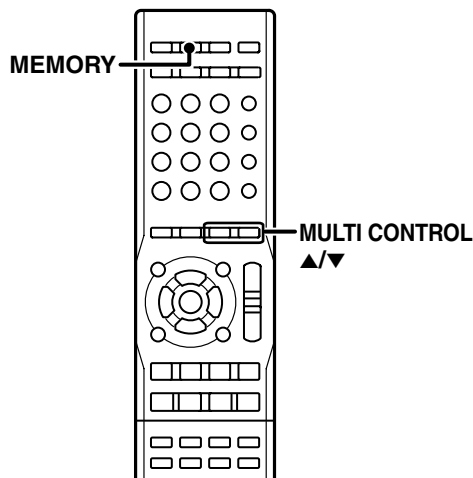

- 1** Tune to the station you want to store.
- 2** Press [MEMORY] while receiving the station.

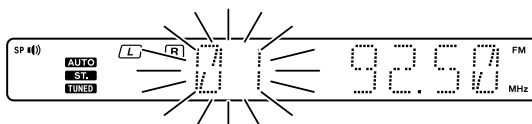

Proceed to step **3** within 20 seconds.
(If more than 20 seconds elapse, press [MEMORY] again.)

- 3** Use [MULTI CONTROL ▲/▼] to select one of the station presets (1 – 40).
- 4** Press [MEMORY] again to confirm the setting.
 - Repeat steps **1**, **2**, **3**, and **4** to store as many stations as necessary.
 - If you store a station at a previously used preset, the previous station will be replaced by the new one.

Receiving preset stations

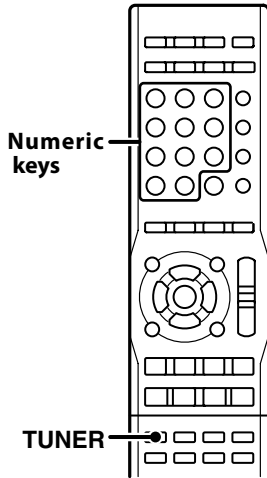

- 1** Press [TUNER] to select tuner as the source.
- 2** Enter the number of the preset station you want to receive (up to "40" preset numbers).
Press the Numeric keys in the following order:
For "15" : press [+10], [5]
For "20" : press [+10], [+10], [0]

- If you make a mistake entering a two digit number, press [+10] repeatedly to return to the original display and start again.



Preset number

Receiving preset stations in order (P.CALL)

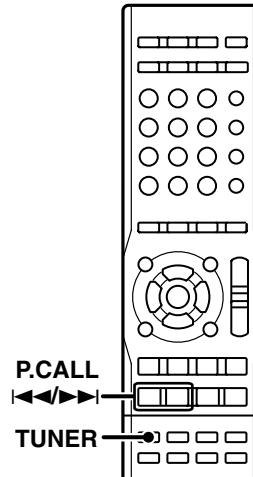

- 1** Press [TUNER] to select tuner as the source.
 - 2** Use [P.CALL <=>/>=>] to select the desired station.
Each time you press the key, another preset station is received in order.
- Holding down the [P.CALL >>>/<<<], lets you skip through the presets, receiving each preset station at 0.5 second intervals.

Tuning by Program Type (PTY search)

This function lets you set the tuner to automatically search for stations which are currently broadcasting the type of program (genre) you want to listen to.

Under certain receiving conditions, it may take more than 1 minute to complete the search.

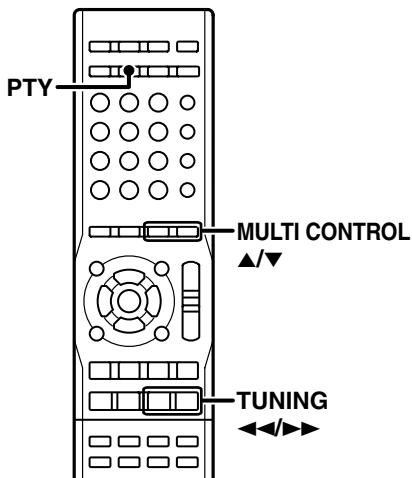

Preparations

- Execute the RDS auto memory procedure.
- Set the broadcast band to FM.
- Tune to an RDS station.

1 Press [PTY] to activate the PTY search mode.

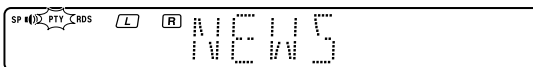

When an RDS broadcast is received, the program type is shown on the display. If no PTY data is available, or if the station is not an RDS station, "NONE" is displayed.

2 While the "PTY" indicator is lit, use [MULTI CONTROL ▲/▼] or [TUNING ◀/▶] to select the program type of your choice.

Program type	Display	Program type	Display
Pop Music	"POP M"	Weather	"WEATHER"
Rock Music	"ROCK M"	Finance	"FINANCE"
Easy Music	"EASY M"	Children's Program	"CHILDREN"
Light Classical Music	"LIGHT M"	Social Affairs	"SOCIAL"
Serious Classical Music	"CLASSICS"	Religion	"RELIGION"
Other Music	"OTHER M"	Phone In	"PHONE IN"
News	"NEWS"	Travel	"TRAVEL"
Current Affairs	"AFFAIRS"	Leisure	"LEISURE"
Information	"INFO"	Jazz Music	"JAZZ"
Sport	"SPORT"	Country Music	"COUNTRY"
Education	"EDUCATE"	National Music	"NATION M"
Drama	"DRAMA"	Oldies Music	"OLDIES"
Culture	"CULTURE"	Folk Music	"FOLK M"
Science	"SCIENCE"	Documentary	"DOCUMENT"
Varied Speech	"VARIED"		

3 Press [PTY] to start searching.

Example: Searching for a Rock Music broadcast.

Display while searching.

Blinks

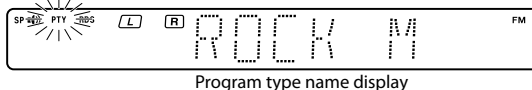

Program type name display

Display when a station is received.

Goes out



Station name display

- No sound is heard while "PTY" is blinking.
- If the desired program type cannot be found, "NO PROG" is displayed, then after several seconds the display returns to the original display.

To select another program type

Repeat steps **1**, **2** and **3**.

Using the RDS DISP. (display) key

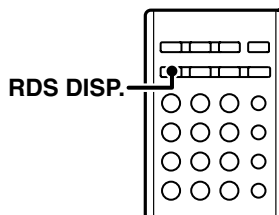

Pressing [RDS DISP.] changes the contents of the display.

Each press switches the display mode as follows:

- ① PS (Program Service) name display
- ② RT (Radio Text) display
- ③ Frequency display

① PS (Program Service) name display:

The station name is displayed automatically when an RDS broadcast is received.

If no PS data was sent, "NO PS" is displayed.



② RT (Radio Text) display:

Text data accompanying the RDS broadcast scrolls across the display. "NO RT" or "RT-----" is displayed if the current RDS station does not provide RT data.



③ Frequency display:

Displays the frequency of the current station.

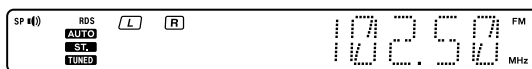

Recording

Recording mode setting in digital audio source recording (main unit only)

When recording a multi-channel digital audio source, it is recommended to set up the recording mode properly to convert the digital input into the 2-channel analog output. Usually use the "A-REC" (Auto record) mode. However, some discs often produce sound skipping. The "M-REC" (Manual record) mode should be used with such a disc.

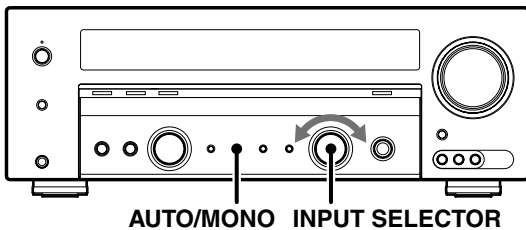

- 1 Use [INPUT SELECTOR] to select the source (CD/DVD, DVD/6CH or VIDEO2) you want to record.
- 2 Set the MD or TAPE recorder to record.
- 3 Press and hold [AUTO/MONO] for more than 2 seconds to select a recording mode during digital input.

Recording mode	Display	Operation
Recording mode off	---	The digital input record mode is switched off.
Auto record mode	"A-REC"	The digital input signals (DTS, Dolby Digital or PCM) are identified automatically and converted into stereo signals that are ready for recording.
Manual record mode	"M-REC"	The input signal type at the moment this mode is selected is held throughout this mode.

- When the "M-REC" mode is selected, the digital input signal is converted to stereo signals (down-mix). But once the digital signal is changed to other signal, no signal is output.
- When the "A-REC" mode is selected, the digital input signal is converted to stereo signals even if the digital signal is changed.
- When the digital mode changes during recording in the "A-REC" mode, the audio input source may be interrupted momentarily.

For "A-REC" mode:

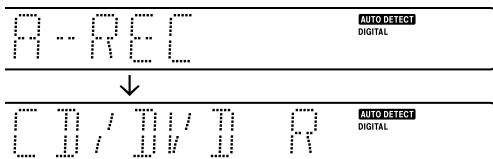

For "M-REC" mode:

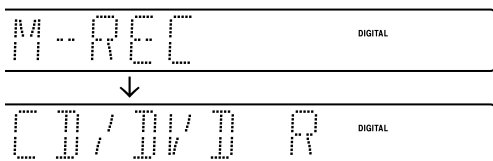

4 Start playback, then start recording.

- If the audio reproduction stops in the middle due to change in the input signals, etc., press [AUTO/MONO].

Recording audio (analog sources)

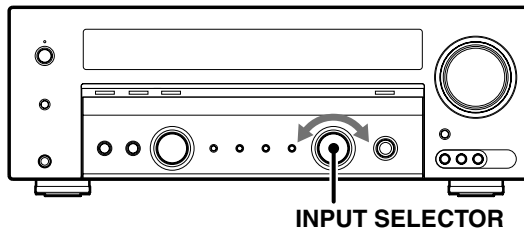

- 1 Use [INPUT SELECTOR] to select the source (other than "MD/TAPE") you want to record.
- 2 Set the MD or TAPE recorder to record.
- 3 Start playback, then start recording.

Recording video

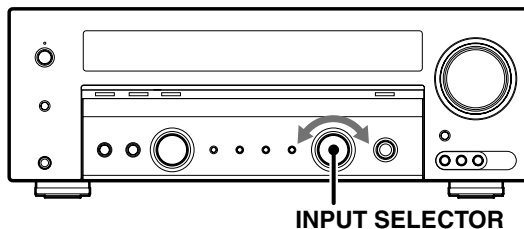

- 1 Use [INPUT SELECTOR] to select the video source (other than "VIDEO1") you want to record.
- 2 Set the video deck connected to VIDEO 1 to record.
 - Select the REC MODE to record a digital input source. See <Recording mode setting in digital audio source recording>.
- 3 Start playback, then start recording.
 - Recording may not be normal for some video software. This is due to the copy guard condition.

Further adjustments

Fine adjustment of the sound

You can make further adjustments to the sound while listening to playback in the surround mode.

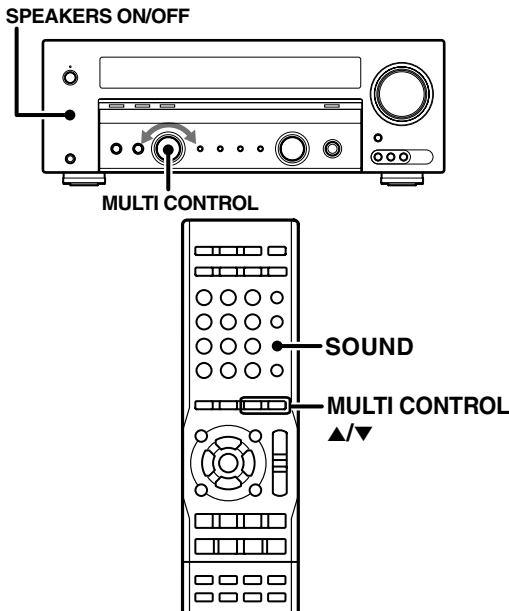

- 1 Press [SOUND] until the desired item appears on the display.

Each time you press the key, the menu changes as follows. Note that some items are not displayed depending on speaker settings and listen mode.

Display	Adjustment	Range
"C"	Center speaker level *1	-10 – +10dB
"RS"	Surround right speaker level *1	-10 – +10dB
"LS"	Surround left speaker level *1	-10 – +10dB
"SW"	Subwoofer level *1	-10 – +10dB
"INPUT"	Input level *2	-6, -3, 0
"NIGHT"	Midnight mode *3	"ON", "OFF"
"PANORAMA"	Panorama mode *4	"ON", "OFF"
"DIMENSION"	Dimension *4	
"CENTER WIDTH"	Center width *4	
Input source name	Exit the adjustment mode.	

*1 The adjustment is only temporary for the current input selection. The value will return automatically to the original setup value when the power is turned on/off or when the input selection is changed.

*2 Analog mode only

*3 Dolby Digital and DTS mode only

*4 Pro Logic II Music mode only

- 2 Use the [MULTI CONTROL ▲/▼] to adjust the setting as desired.

Speaker level adjustment

The output level from the desired speaker channels can be fine adjusted according to the properties of each disc. The adjustment is only temporary for the current input selection. The value will return automatically to the original setup value when the power is turned on/off or when the input selection is changed.

- 1 Press [SOUND] repeatedly until the speaker to be adjusted appears on the display. ("C", "RS", "LS", or "SW")
- 2 Use the [MULTI CONTROL ▲/▼] to adjust the level.

Input level adjustment (analog sources only)

If the input level of an analog source signal is too high, the CLIP indicator will blink to indicate. Adjust the input level.



- 1 Press [SOUND] repeatedly until "INPUT" appears on the display.
- 2 Use the [MULTI CONTROL ▲/▼] to adjust the level.



Midnight mode (Dolby Digital and DTS mode only)

When watching movies at night, you might not be able to raise the volume as loud as normal. Midnight mode compresses the dynamic range of previously specified heavy sound passage of the Dolby Digital and DTS mode sound track (like scenes with sudden increases in volume) to minimize the difference in volume between the scenes with heavy sound passage and scenes with normal sound passage. This makes it easy to hear all of the sound track, even when listening at low volumes.

- 1 Press [SOUND] repeatedly until "NIGHT" appears on the display.

This can be selected only if "CD/DVD", "DVD/6CH" or "VIDEO2" is selected as the source and the listen mode is set to "DOLBY DIGITAL" or "DTS".

- 2 Use [MULTI CONTROL ▲/▼] to select the "ON" or "OFF" setting.



- Some Dolby Digital or DTS software may not be compatible with the Midnight mode.

Panorama mode (Pro Logic II Music mode only)

When listening to music, you will be able to enjoy the "wraparound" sound effect when you adjust the panorama mode.

1 Press [SOUND] repeatedly until "PANORAMA" appears on the display.

- The "PANORAMA" setting indication scrolls across the display.



"PANORAMA" will be scrolled from right to left.

2 Use [MULTI CONTROL ▲/▼] to select the "ON" or "OFF" setting.

- "ON" : PANORAMA mode is ON.
- "OFF" : PANORAMA mode is OFF.



Dimension mode (Pro Logic II Music mode only)

When listening to music with certain recordings, you will also be able to achieve a suitable balance from all the speakers by adjusting the dimension mode.

1 Press [SOUND] repeatedly until "DIMENSION" appears on the display.

- The "DIMENSION" indication scrolls across the display.

2 Use [MULTI CONTROL ▲/▼] to adjust the soundfield towards the rear or the front.

Soundfield is adjusted towards the front.

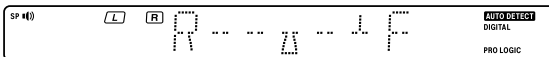

Soundfield is in neutral position.

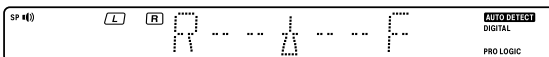

Soundfield is adjusted towards the rear.

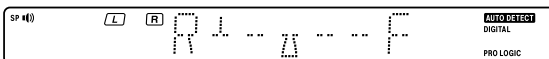

Center Width mode (Pro Logic II Music mode only)

Center Width adjustment allows you to enjoy an enhanced sound when listening to music through center image from only center speaker, or left and right speakers or various combinations adjustments.

1 Press [SOUND] repeatedly until "CENTER WIDTH" appears on the display.

- The "CENTER WIDTH" indication scrolls across the display.

2 Use [MULTI CONTROL ▲/▼] to adjust the left-center-right output.

Center image will be heard from Center speaker only.

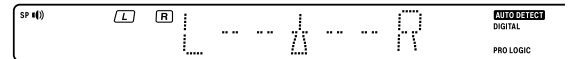

Center image will be heard from Left and Right speakers only.

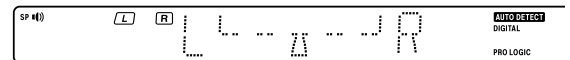

- When in other positions, center image from Center speaker, Left and Right speakers can be heard simultaneously with various combinations.
- When the center speaker is switched OFF, this mode will not be effective.

Additional functions

Convenient functions

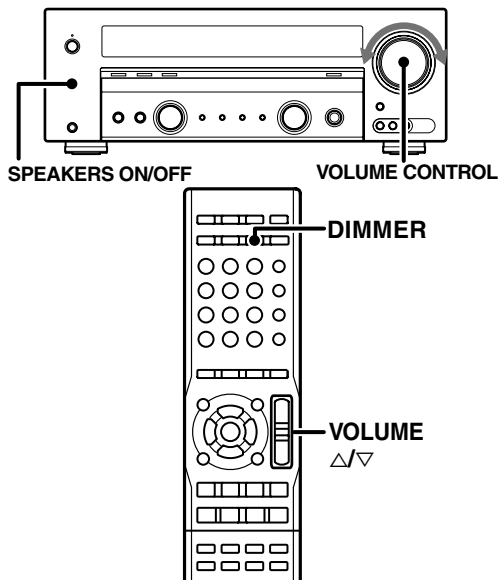

Display dimmer adjustment

The dimmer function lets you select the brightness of the display and indicators of this unit. You might find this useful if you darken your room to watch movies or listen to music.

Press [DIMMER].

The brightness of the display changes among the three available settings. Select the brightness level you find most pleasing.

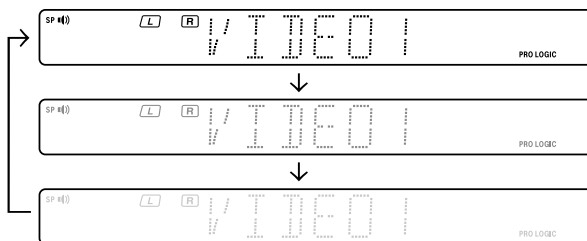

- The brightness of the LED indicators changes in 2 levels.

Listening with headphones (main unit only)

1 Press [SPEAKERS ON/OFF] so that the speaker indicator goes off.

Make sure the "SP" indicator is turned off.

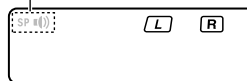

- If you turn off all of the speakers when in surround mode, the surround mode will be canceled as well, resulting in stereo playback.

2 Connect headphones to the PHONES jack.

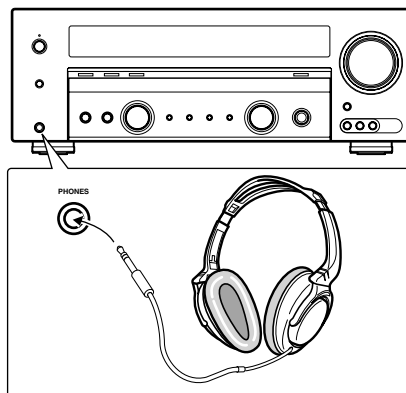

3 Use [VOLUME ▲/▼] to adjust the volume.

Remote control operations for Kenwood DVD players

The remote control of this unit can control Kenwood DVD players directly without using the remote control supplied with the DVD player. DV-4900, DV-4070B, DV-2070, DV-203, DVF-9010, DVF-K7010, DVF-5010, DVF-R9030, DVF-R7030, DVF-3530, DV-402, DV-5900, DV-5700, DVF-R9050, DVF-J6050, DV-505, DV-503, DV-502, DVF-3550, DVF-3050, DVF-R4050, DVF-605, DV-6050, DVF-R5060, DVF-3060, DVF-3060K, DV-705, DVF-R5070, DVF-3070, DVF-3080, DVF-N7080, DVF-8100, DVF-3200, DVF-3250, DVF-3300, DVF-3400, DVF-5400, DVF-3500 and DVF-5500.

How to operate the DVD player with the remote control

- 1 Press [DVD] to turn the DVD player on.
- 2 Press [CD/DVD] or [DVD/6CH] to operate the functions of the DVD player.
- 3 Press each key for DVD player operation. Refer to the operation manual of the DVD players for the detailed operating instructions.
(To return to the receiver operation mode, press other Input source key.)

DVD player operation keys

You can perform these basic operations using the keys described below when connected to Kenwood DVD player.

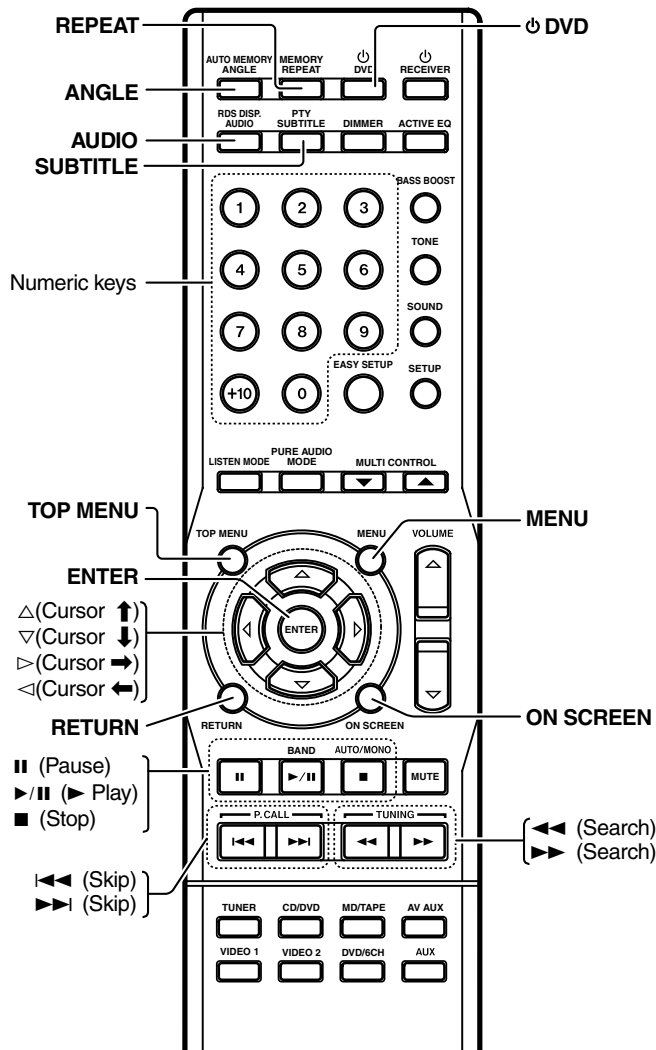

Troubleshooting

Troubles are not always due to malfunction or failure of the system. In case of a trouble, check the following tables before calling for service.

Amplifier

Symptom	Cause	Remedy
No sound from the speakers.	The speaker cords are disconnected.	Connect it properly referring to <Connecting the speakers>. → 14
	VOLUME is set to the minimum position.	Adjust the volume to a proper level.
	MUTE is ON.	Turn OFF the MUTE. → 22
	The SPEAKERS switches are set to OFF.	Set the SPEAKERS switch to ON. → 20
The standby indicator blinks and sound is not output.	Speaker cords are short-circuited.	Turn the power off, eliminate the short-circuiting, then turn on the power again.
	There may be an internal defect.	If the standby indicator still blinks after eliminating the short-circuiting, there may be an internal defect. Switch it off, unplug the power cord and call for service.
Sound is not output from one of the speakers.	The speaker cord is disconnected.	Connect it properly referring to <Connecting the speakers>. → 14
	The speaker is not set up correctly.	Set it up properly referring to <Speaker settings>. → 16
Sound is not output from the surround speakers and/or the center speaker, or their sound is very soft.	The surround speaker cords and/or the center speaker cord is disconnected.	Connect it properly referring to <Connecting the speakers>. → 14
	The speaker is not set up correctly.	Set it up properly referring to <Speaker settings>. → 16
	A surround mode has not been activated.	Select a surround mode. → 25
	The surround and/or center volume controls are set to the minimum level.	Adjust the speaker levels using the test tone. → 18
When playing a Dolby Digital source signal using a DVD player, the sound is cut off soon after it starts.	There are many possible causes for this problem, depending on the type of DVD player used.	Set the input mode to digital manual before starting playback of the Dolby Digital source. → 20
No sound is produced during playback from a DVD player.	The input mode is set to digital manual.	Press the [INPUT MODE] key to select to full auto mode. → 20
A video source cannot be recorded normally.	The software is copy-guarded.	Copy-guarded video software cannot be recorded.
No video output.	PURE AUDIO MODE is on.	Turn off the PURE AUDIO MODE. → 21
Display is turned off.	PURE AUDIO MODE is on.	While the PURE AUDIO MODE is on, the display is turned off. → 21

Tuner

Symptom	Cause	Remedy
Radio stations cannot be received.	No antenna is connected.	Connect an antenna. → 15
	The broadcast band is not set properly.	Set the broadcast band properly. → 27
	The frequency of the desired station is not tuned.	Tune the frequency of the desired station. → 27
Interference	Noise due to ignition of an automobile.	Install the outdoor antenna away from the road.
	Noise due to interference from an electric appliance.	Turn off the power to the appliance.
	Noise due to a nearby TV set.	Install the unit farther away from the TV.
A station which was preset cannot be received by pressing the corresponding numeric key.	The preset station belongs to a frequency that cannot be received.	Preset a station with a receivable frequency. → 28
	The preset memory was cleared because the power cord had been unplugged for a long period of time.	Preset the station again. → 28

Remote control unit

Symptom	Cause	Remedy
Remote control operation is not possible.	The remote control is set to the DVD player operation mode.	Press any of the Input Source keys to select the appropriate operation mode.
	Batteries are exhausted.	Replace with new batteries.
	The remote control unit is too far away from the main system, controlling angle is too large, or there is an obstacle between this unit and the remote.	Operate the remote control unit within the controllable range. 
	The remote control has not been changed to the operation mode for the Kenwood DVD player you wish to control.	Press the [CD/DVD] or [DVD/6CH] key to activate the operation mode for the component you want to control before operation.

Resetting the Microcomputer

The microcomputer may malfunction (unit cannot be operated, or shows an erroneous display) if the power cord is unplugged while the power is ON, or due to some other external factor. If this happens, execute the following procedure to reset the microcomputer and return the unit to its normal operating condition.

While holding down [⏻] key on the unit, unplug the power cord and plug it back in.

- Please note that resetting the microcomputer will clear the contents of the memory and return the unit to the state it was in when it left the factory.

Memory back up function

Please note that the following items will be deleted from the unit's memory if the power cord is disconnected from the AC outlet for approximately 1 day.

- **Input selector settings**
- **Volume level**
- **BASS, TREBLE, INPUT level**
- **TONE ON/OFF**
- **ACTIVE EQ mode**
- **Dimmer level**
- **Speaker settings**
- **Sound Adjustment (Input level, Midnight mode, Panorama mode, Dimension mode, Center Width mode)**
- **Listen mode setting**
- **Tuner setting**

In regard to contact cleaner

Do not use contact cleaners because it could cause a malfunction. Be specially careful not to use contact cleaners containing oil, for they may deform the plastic component.

Maintenance of the unit

When the front panel or case becomes dirty, wipe with a soft, dry cloth. Do not use thinner, benzene, alcohol, etc. for these agents may cause discoloration.

Specifications

AUDIO section

Rated output power during STEREO operation (63 Hz – 12.5 kHz, 0.7% T.H.D., at 6 Ω).....	100 W + 100 W
Effective output power during STEREO operation RMS (1 kHz, 10% T.H.D., at 6 Ω)	120 W + 120 W
Effective power output during SURROUND operation	
FRONT	
(1 kHz, 0.7 % T.H.D. at 6 Ω one channel driven) 100 W + 100 W	
(1 kHz, 10 % T.H.D. at 6 Ω one channel driven) 120 W + 120 W	
CENTER	
(1 kHz, 0.7 % T.H.D. at 6 Ω one channel driven)	100 W
(1 kHz, 10 % T.H.D. at 6 Ω one channel driven)	120 W
SURROUND	
(1 kHz, 0.7 % T.H.D. at 6 Ω one channel driven) 100 W + 100 W	
(1 kHz, 10 % T.H.D. at 6 Ω one channel driven) 120 W + 120 W	
Total harmonic distortion	0.05 % (1 kHz, 50 W, 6 Ω)
Frequency response (IHF'66)	
CD/DVD	20 Hz – 70 kHz, +0 dB – –3.0 dB
Signal to noise ratio (IHF'66)	
CD/DVD	100 dB
Input sensitivity / impedance	
CD/DVD, AUX, MD/TAPE, VIDEO 1, VIDEO 2	550 mV / 40 kΩ
AV AUX	550 mV / 50 kΩ
DVD/6CH INPUT	550 mV / 27 kΩ
Output level / impedance	
REC OUT (MD/TAPE, VIDEO 1)	550 mV / 470 Ω
PRE OUT (SUBWOOFER)	1.5 V / 1.5 kΩ
Tone control	
BASS	±10 dB (at 100 Hz)
TREBLE	±10 dB (at 10 kHz)

DIGITAL AUDIO section

Sampling frequency	32 kHz, 44.1 kHz, 48 kHz, 96 kHz
Input level / wave length	
Optical	-15 dBm – –21 dBm / 660 nm ±30 nm
Input level / impedance	
Coaxial	0.5 Vp-p / 75 Ω

VIDEO section

VIDEO inputs / impedance	
VIDEO (composite)	1 Vp-p / 75 Ω
VIDEO outputs / impedance	
VIDEO (composite)	1 Vp-p / 75 Ω
COMPONENT VIDEO inputs/ impedance (For Australia)	
COMPONENT VIDEO (Y-signal)	1 Vp-p / 75 Ω
COMPONENT VIDEO (CB/ CR-signal)	0.7 Vp-p / 75 Ω
COMPONENT VIDEO outputs/ impedance (For Australia)	
COMPONENT VIDEO (Y-signal)	1 Vp-p / 75 Ω
COMPONENT VIDEO (CB/ CR-signal)	0.7 Vp-p / 75 Ω

FM tuner section

Tuning frequency range	87.5 MHz – 108.0 MHz
Usable sensitivity (DIN at 75 Ω)	
MONO	1.3 μV / 13.2 dBf (40 kHz DEV., S/N 26 dB)
STEREO	45 μV / 42.1 dBf (46 kHz DEV., S/N 46 dB)
Total harmonic distortion (DIN at 1 kHz)	
MONO	0.2% (71.2 dBf input)
STEREO	0.8% (71.2 dBf input)
Signal to noise ratio (DIN weighted at 1 kHz)	
MONO	65 dB (40 kHz DEV., 71.2 dBf input)
STEREO	60 dB (46 kHz DEV., 71.2 dBf input)
Stereo separation (DIN 1 kHz)	36 dB
Selectivity (DIN ±300 kHz)	64 dB
Frequency response (30 Hz – 15 kHz)	+0.5 dB, –3.0 dB

AM tuner section

Tuning frequency range	531 kHz – 1,602 kHz
Usable sensitivity (30% mod., S/N 20 dB)	16 μV / (600 μV/m)
Signal to noise ratio (30% mod.)	
.....	50 dB (60 dBμV EMF input)

General

Power consumption	250 W
Standby power consumption	less than 0.6 W
Dimensions	W: 440 mm (17-5/16")
.....	H: 159 mm (6-1/4")
.....	D: 338 mm (13-5/16")
Weight (net)	8.1 kg (17.9 lb)

Notes:

1. Kenwood follows a policy of continuous advancements in development. For this reason specifications may be changed without notice.
2. The full performance may not be exhibited in an extremely cold location (under a water-freezing temperature).

KENWOOD

For your records

Record the serial number, found on the back of the unit, in the spaces designated on the warranty card, and in the space provided below. Refer to the model and serial numbers whenever you call upon your dealer for information or service on this product.

Model _____ Serial Number _____

Free Manuals Download Website

<http://myh66.com>

<http://usermanuals.us>

<http://www.somanuals.com>

<http://www.4manuals.cc>

<http://www.manual-lib.com>

<http://www.404manual.com>

<http://www.luxmanual.com>

<http://aubethermostatmanual.com>

Golf course search by state

<http://golfingnear.com>

Email search by domain

<http://emailbydomain.com>

Auto manuals search

<http://auto.somanuals.com>

TV manuals search

<http://tv.somanuals.com>