

AM-FM
STEREO TUNER

KT-8300

INSTRUCTION MANUAL



INTRODUCTION

Thank you for purchasing our tuner. Because we take great pride in the long tradition of quality components the name Kenwood represents, your purchase of a Kenwood tuner places you in a distinguished family of connoisseurs of superb high-fidelity sound reproduction.

The purpose of this manual is to acquaint you with the operating features of your new tuner. You will notice that in every detail of planning, engineering, styling, operating convenience, and adaptability, we have sought to anticipate your needs and desires.

We suggest that you read this manual carefully. Knowing how to set up your tuner, to the best advantage, will enhance your listening pleasure right from the start. You will also become aware of the ease with which you can adjust your tuner to meet your special requirements.

Turn the pages and become acquainted with the exciting features of your new tuner that will remain new for endless hours of listening pleasure.

MAINTENANCE

CONCERNING TRANSISTORS

Transistors differ fundamentally from radio vacuum tubes and require special attention to ensure their full performance capabilities. Given proper care, transistors will provide years of practically trouble-free performance.

- (a) Avoid locations subject to direct sunlight.
- (b) Avoid high or low temperature extremes.
- (c) Keep the tuner away from heat radiating sources.

GROUND

Although broadcasts can be received without a ground connection, it is recommended that a good ground connection be made to a buried grounding rod or water pipe to reduce interference and ensure safety. Never use a gas pipe for a ground connection, however.

NOTES

1. Units shipped to the U.S.A. and CANADA are designed to be operated with 120 volts AC only. Units shipped to the Scandinavian countries are designed to be operated with 220 volts AC only. Units shipped to the U.K. are designed to be operated with 240 volts AC only. Therefore the above units are not equipped with an AC Voltage Selector Switch so all reference to such a switch throughout this manual should be disregarded.
2. Units shipped to all other countries are equipped with an AC Voltage Selector Switch on the rear panel that is preset at the factory to the voltage generally available in the destination area. It is very important, however, to check the Voltage Selector Switch setting and make sure that it corresponds to your line voltage before connection the power cord into an AC outlet. If the Voltage Selector Switch requires re-setting, follow the directions outlined on page 5.

CONTENTS

FEATURES	3
INTERCONNECTING DIAGRAM	4
CONNECTING INSTRUCTIONS	5
CONTROLS AND THEIR FUNCTIONS	8
OPERATING INSTRUCTIONS	10
TROUBLE SHOOTING	11

FEATURES

1. Stereo FM Reception Approaching Perfection with D.D. MOS FETs Linearity to 5 MHz, and Exclusive PLL Control Circuit.
2. Dual Diffusion Type MOS FETs and 8-Gang V.C. Up Front.
3. Selectivity Selector and Special Filters for "Unmeasurable" Distortion.
4. Quadrature Process for Wide Range Linearity to 5 MHz.
5. "Only Kenwood" Circuits for Awe-Inspiring Stereo Separation.
6. New Dial Scale in 200 kHz Units.
7. Four Meters for Total Control.
8. A 3-position Muting Switch.
9. Output Level Control and Variable/Fixed Output Terminals.
10. New 75 ohm Connector.
11. Built-in De-emphasiser to Match Any* Dolbized FM Broadcasts.
12. Excellent AM Reception.
13. Multipath Outputs.
14. Rear Cushion Provided.
15. Elegant Styling Matches Technical Excellence.

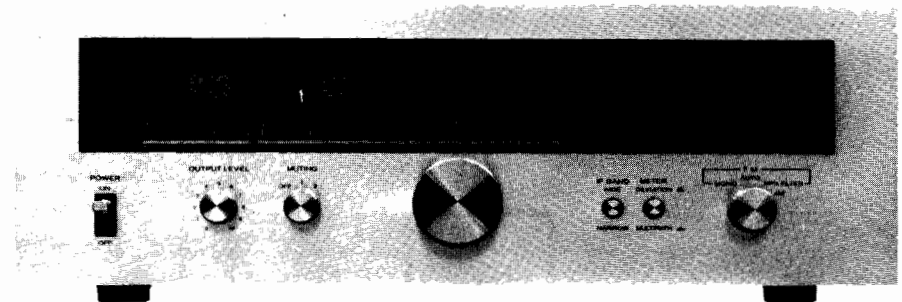

WARNING:
TO PREVENT FIRE OR SHOCK HAZARD,
DO NOT EXPOSE THIS APPLIANCE TO
RAIN OR MOISTURE.

* Dolby is a Trade Mark of Dolby Laboratories, Inc.

INTERCONNECTING DIAGRAM

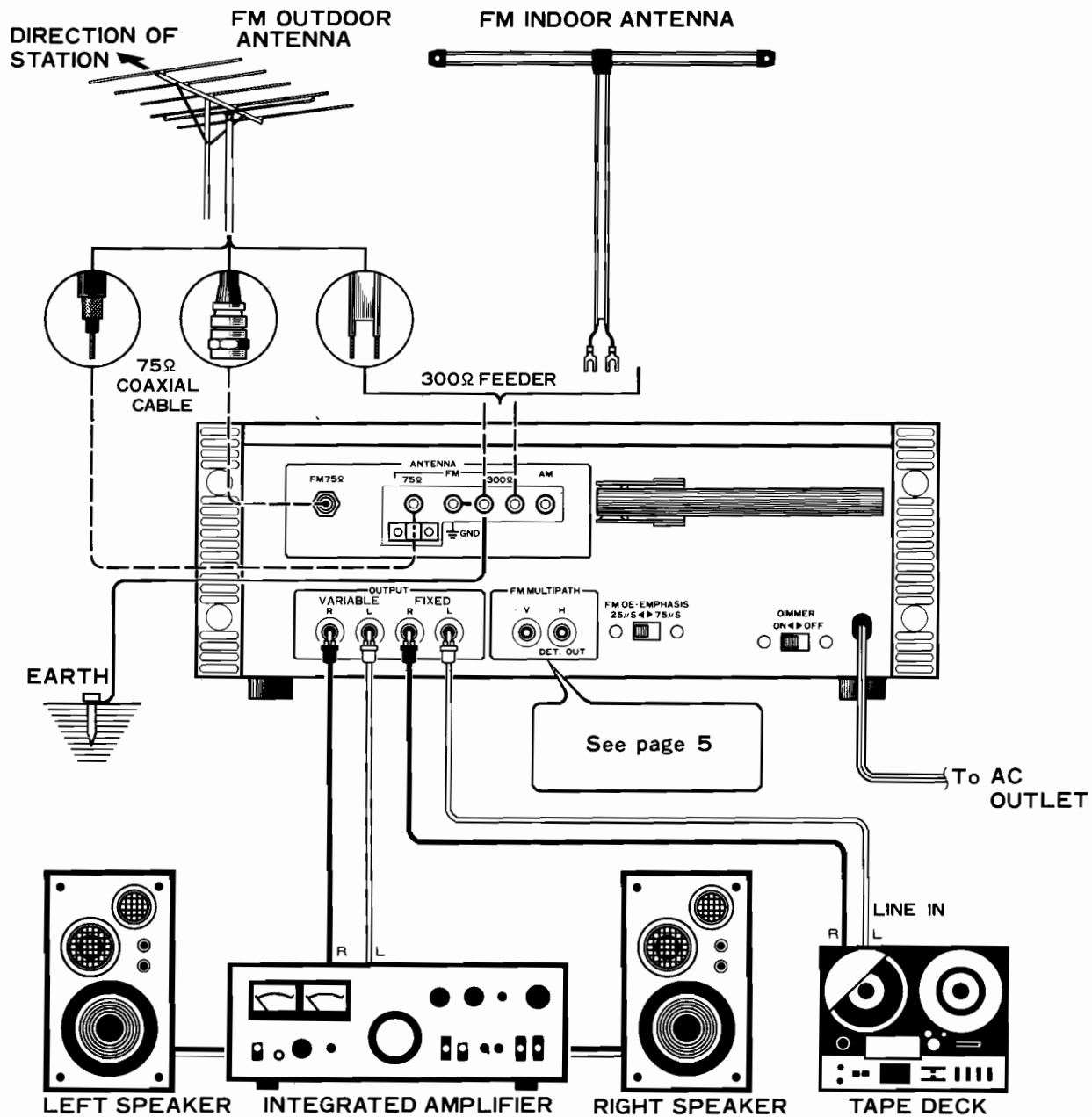

See page 5

CONNECTING INSTRUCTIONS

OUTPUT

VARIABLE

These jacks connect to the stereo amplifier's TUNER or AUX input terminals. The level of these terminals is controlled by the Output Level knob on the front panel.

FIXED

These jacks connect to the tape deck Line Input terminals. The signal level from the output terminals cannot be controlled from the KT-8300; this must be done with the tape deck input level controls.

FM DE-EMPHASIS SWITCH

Selects $75\mu\text{s}$ ($50\mu\text{s}$) or $25\mu\text{s}$ FM DE-EMPHASIS for accurate reception of Dolbyized FM signals. Normally, this switch should be left in the $75\mu\text{s}$ ($50\mu\text{s}$) position. However, if the station is broadcasting the Dolbyized signal using a $25\mu\text{s}$ pre-emphasis, put this switch in the " $25\mu\text{s}$ " position to obtain flat FM frequency response. If in doubt, call the station.

Note: For correct reception of Dolby broadcast, the Dolby Adaptor must be used without fail.

FM MULTIPATH JACKS

This unit is provided with FM multipath jacks through which multipath distortion can be detected in two ways. In one way these jacks are connected with an oscilloscope and the antenna is positioned at the optimum height and in the best direction by observing the displayed wave form until distortion can be lowered to a minimum level. In the other way the antenna is positioned in a direction in which a deflection in the multipath meter on the front panel is reduced to a minimum.

Note: When handling the oscilloscope, please refer to the instruction manual attached to it.

DIMMER SWITCH

The Dial illumination can be dimmed if desired by setting this ON-OFF switch to ON.

DET. OUT (DETECT OUT)

The FM detector circuit output is made available here so that this tuner will be ready for 4-channel broadcasting developments in the future. When FM discrete 4-channel broadcasting becomes a reality, a simple demodulator connected here will enable you to fully enjoy this coming development.

AC VOLTAGE SELECTION

The KT-8300 operates on 110 - 120 volts AC or 220 - 240 volts AC. The AC Voltage Selector Switch on the rear panel is set to the voltage that prevails in the area to which the tuners are shipped. Before operating this tuner, make sure that the position of the AC Voltage Selector Switch matches your line voltage. If not, it must be changed to the proper setting.

To change, first disconnect the AC power cord. Then remove the stopper plate and slide the AC Voltage Selector Switch to the opposite side. Then reattach the stopper plate to the other side.

Note: Our warranty does not cover damage caused by excessive line voltage due to improper setting of the AC Voltage Selector Switch.

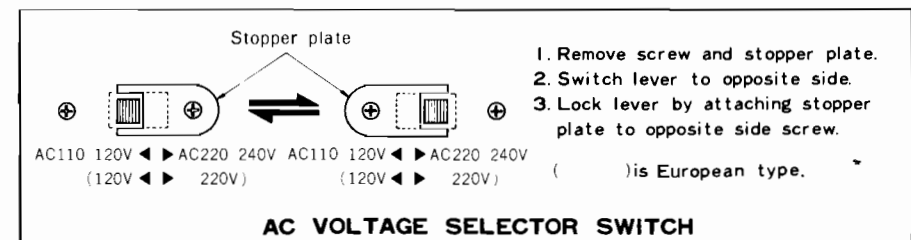

CONNECTING INSTRUCTIONS

FM ANTENNA

Four terminals are provided for connection to a 300 or 75 ohms FM antenna as shown below.

For good FM stereo reception, always use the best antenna possible. In areas close to the transmitter, a simple T-Type antenna may suffice. It should be remembered, however, that the pickup of reflections (similar to "ghosts" on TV) will result in poor stereo reception.

These reflections must therefore be reduced to a minimum, either by careful orientation of the indoor dipole antenna or, if this will not eliminate them, by using a more directional outdoor type antenna.

In areas a greater distance from the transmitter, the use of an outdoor antenna is highly recommended. These are available in various types. For reception of stations scattered in many directions, a non-directional type antenna will offer better results. When using a directional antenna, always orient it for the best reception of the desired station. The correct position will be indicated by maximum deflection of the Signal Meter on your tuner.

Keep FM antennas away from roads.

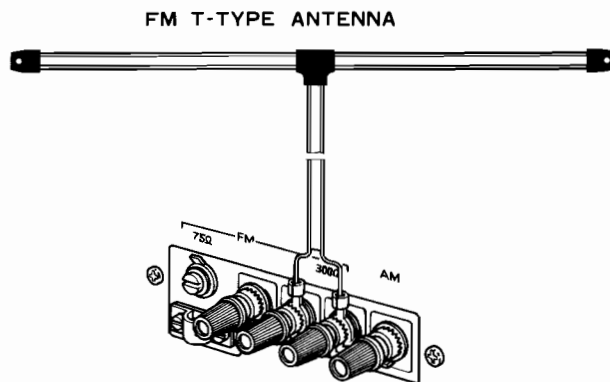
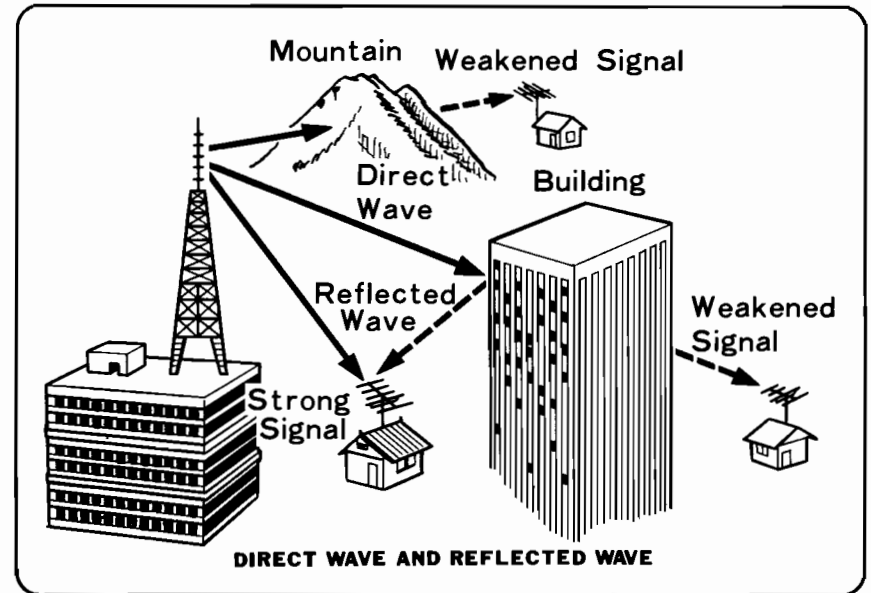

TWIN LEAD (300Ω) CONNECTION

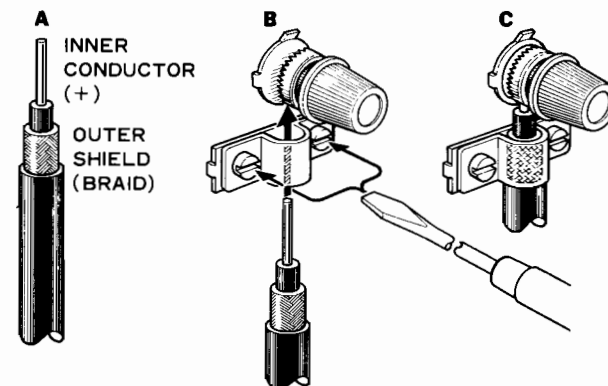

Strip the coaxial cable as shown in (A).
Loosen the screws and connect the cable as shown in (B).
Then tighten all screws for a connection like (C).

COAXIAL CABLE (75Ω) CONNECTION

CONNECTING INSTRUCTIONS

1. Arrange the coaxial cable 3C 2V as illustrated.

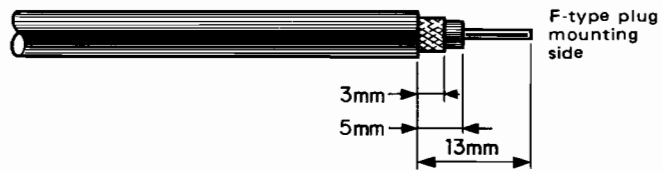

2. Mount the F-type plug on the coaxial cable 3C 2V.

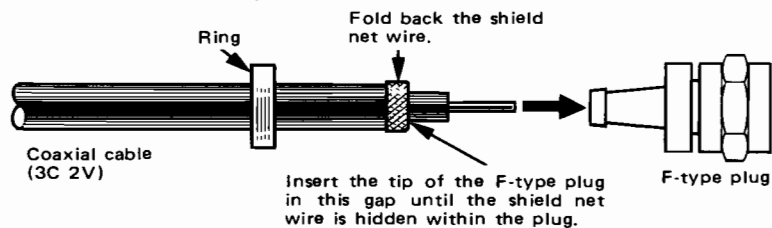

3. Move the ring to the illustrated position and flatten it with pliers.

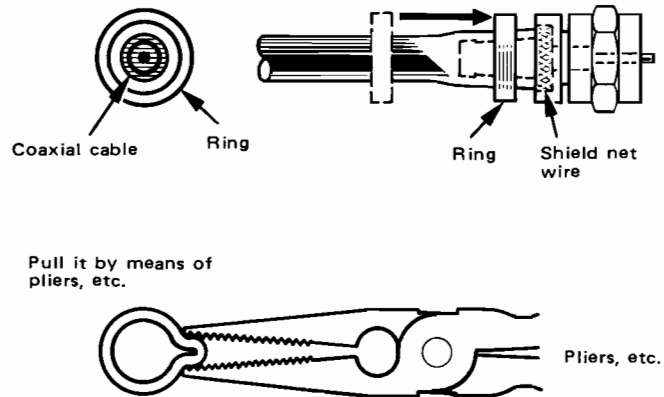

COAXIAL CABLE(75Ω) CONNECTION

AM ANTENNA

The ferrite stick antenna mounted at the rear panel of the tuner will provide satisfactory reception of local stations with strong signals. Because the ferrite stick antenna has directive properties, its direction should be adjusted for best reception while listening to a station. (See Figure below)

AC cords laid adjacent to AM ferrite stick antenna may interfere with reception. Keep them away as far as possible from the ferrite stick antenna.

In fringe areas or in locations surrounded by steel frame buildings where satisfactory reception cannot be obtained with the ferrite stick antenna, an AM outdoor antenna should be connected to the AM terminal.

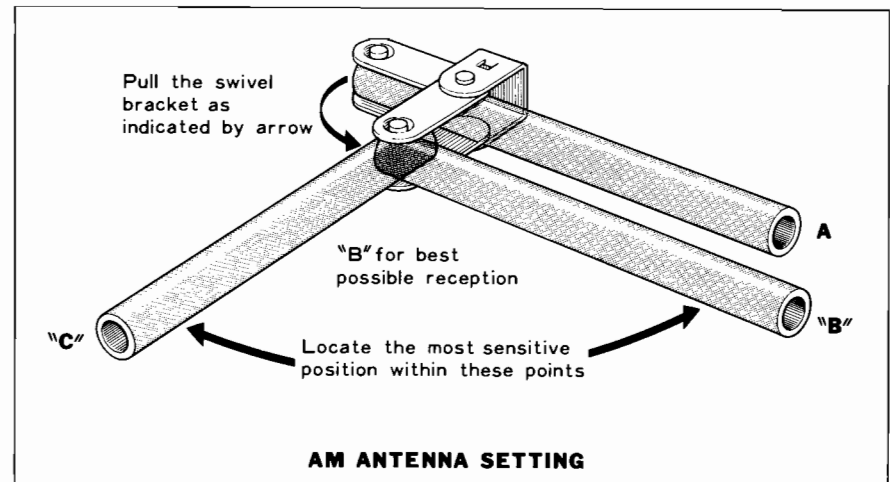

AM ANTENNA SETTING

CONTROLS AND THEIR FUNCTIONS

① POWER SWITCH

Move up to ON to power the set, down to turn it OFF.
The dial indicator lights when the power is on.

② OUTPUT LEVEL CONTROL

The signals passing from the OUTPUT (VARIABLE) terminals can be controlled by the OUTPUT LEVEL knob. Use the controls in the following situations:

- 1) When the KT-8300 is connected to a stereo amplifier and the output level is too high for the input terminals, or too low.
- 2) When the tuner output level does not match that of other units (turntable, tape deck, etc.) connected to the amplifier. When there is a difference in output levels between AM performance and FM performance.

③ MUTING SWITCH

This switch silences interstation noise on the FM band.

The switch positions and functions are as follows:

- 1: Use this setting when the (2) setting cancels the desired station along with the noise.
- 2: To tune in a strong signal station.

Note: When tuning to a weak signal station, turn the MUTING switch off. This will not affect the noise, etc., but such interference usually disappears when you are near or right on the station at any rate.

④ TUNING KNOB

Use the tuning knob to select the AM and FM station desired.
Adjust further by tuning for maximum deflection of the SIGNAL meter while listening to the speaker output.

⑤ IF BAND SELECTOR

Switch positions and functions are as follows:

WIDE — This setting is suitable for normal usage in an area where no radio interference occurs. Reception with a low distortion can be expected.

NARROW — This switch is depressed if radio interference with an adjacent station is rigorous.

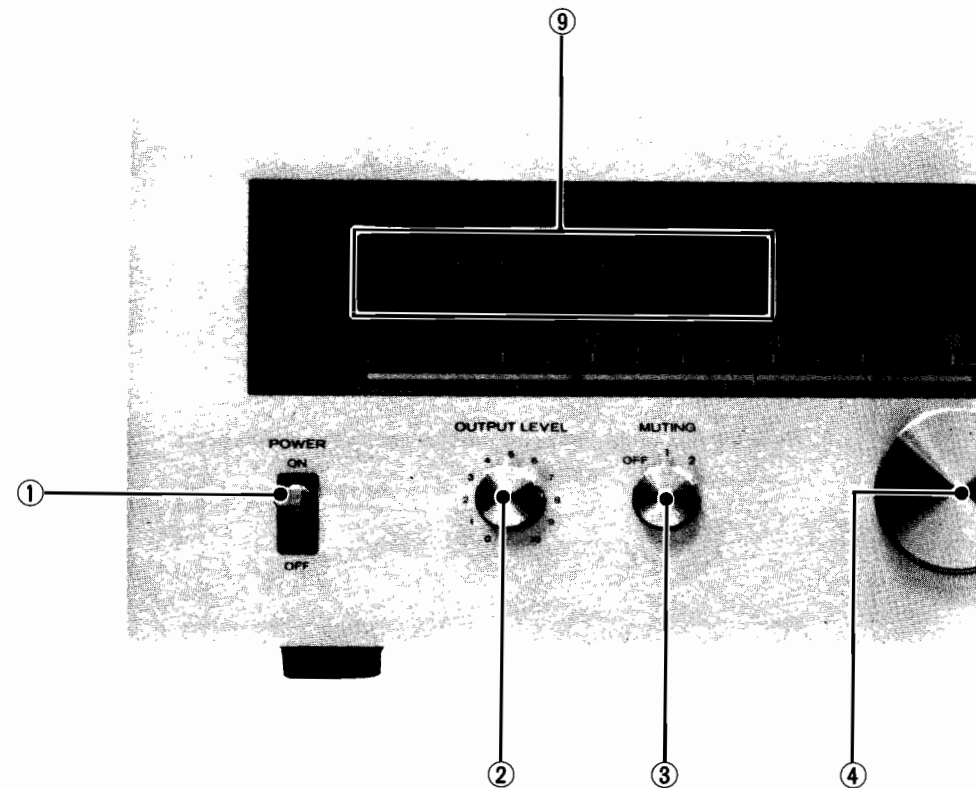

CONTROLS AND THEIR FUNCTIONS

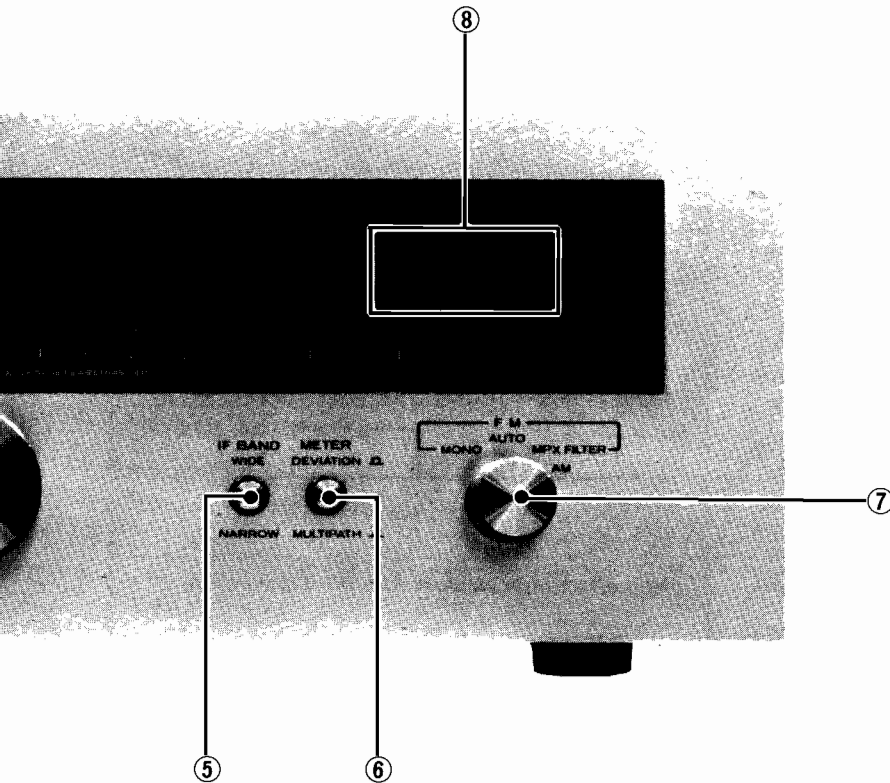

⑥ METER SWITCH

Switch positions and functions are as follows:

BUTTON DEPRESSED — The DEVIATION/MULTIPATH Meter acts as a MULTIPATH Meter.

BUTTON RELEASED — The DEVIATION/MULTIPATH Meter acts as a DEVIATION Meter.

⑦ SELECTOR SWITCH

FM MONO — For FM monaural reception.

FM AUTO — For reception of both FM monaural and stereo. The tuner will automatically identify and separate FM stereophonic broadcasts. When an FM stereo broadcast is tuned in the STEREO indication lights up.

MPX FILTER — Unlike FM monaural reception, high frequency noise may sometimes be encountered when receiving FM stereophonic broadcasts. The MPX FILTER in this tuner effectively cuts such disturbances. This switch has nothing to do with monaural reception.

AM — For AM reception.

⑧ DEVIATION/MULTIPATH METER

DEVIATION — Functions as a meter which indicates a peak value of the modulation degree for FM broadcast. This meter makes it possible to monitor the maximum modulation degree for the received FM broadcast signal. If used in combination with the VU meter of the tape deck, an optimum recording level can be obtained.

MULTIPATH — Functions as a multipath detection meter. Reception with a minimal distortion is possible by depressing this switch and positioning the antenna in a direction where this meter gives a minimum deflection.

⑨ SIGNAL/TUNING METER

SIGNAL METER — This meter indicates incoming signal strength at the antenna with correct linearity from the weakest to the strongest signals.

TUNING METER — This meter is used for precise tuning to the center of the FM channel. Turn the tuning knob until meter pointer is at the center of the heavy black area of the meter scale. Center tuning provides maximum separation and minimum distortion.

OPERATING INSTRUCTIONS

FM RECEPTION

1. Set the Selector switch to FM AUTO.
2. Set the MUTING LEVEL switch to OFF.
This switch cuts FM noise between stations with an efficiency that varies according to 1 (weak) or 2 (strong) settings. But it also affects reception of weak FM signals, and should therefore be left off except when tuning. For details, see the facing page.
3. Turn the TUNING knob to select a station. First tune so that the SIGNAL meter needle swings as far to the right as possible, then finish the precise tuning by centering the TUNING meter needle. If the STEREO indicator lamp lights, the broadcast is in stereo; if not, it is monophonic.
4. Set the OUTPUT LEVEL knob to its central position. For details, see the facing page.
5. If you are using a stereo amplifier, set its controls for the desired volume level and tonal quality.
6. If continuous high-frequency noise occurs during FM stereo listening, set the Selector switch to MPX FILTER position.

Note: It may be impossible to eliminate noise from an FM stereo broadcast if the signal is extremely weak. In such a case the relative signal strength can be improved by switching to FM MONO with the Selector switch. While the stereo effect will be lost somewhat, a great deal of the noise can be substantially eliminated in this way.

AM RECEPTION

1. Set the Selector switch to position AM.
2. Turn the tuning knob to select a station. Tune in so that the SIGNAL meter needle swings as far to the right as possible.
3. If you are using a stereo amplifier, set its controls for the desired volume level and tonal quality.

GROUND

For optimum safety and noise-free performance be sure the GND terminal is connected to a good ground.

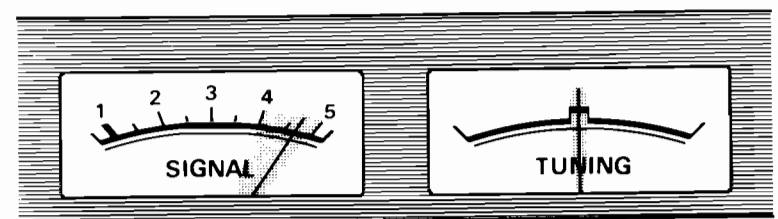

SIGNAL METER

TUNING METER

TROUBLE SHOOTING

In initially installing this tuner, improper connections may result in one of the following indications. Their possible causes and corrective measures are listed below to facilitate installation. If you cannot find or correct it, see your audio dealer.

SYMPTOM	PROBABLE CAUSE	CORRECTION
Continuous low frequency buzz. Most noticeable at night on weak signal stations. Poor AM reception.	Interference from electrical appliances or atmospherics. In ferroconcrete buildings or in areas remote from the broadcasting station.	Erecting a 10 meter outdoor antenna and securing good ground conditions should reduce interference considerably. Complete elimination is difficult. An outdoor antenna necessary.
Continuous high frequency whine which increases at night.	TV interference. 10 kHz beat interference from adjacent AM station.	Turn TV off. (Neighboring TV set may also be the cause). Impossible to eliminate from tuner side. Use MPX Filter to cut off high frequency interference, amplifier side.
Intermittent buzzing or sharp cracking noise.	Lightning interference. Interference from fluorescent lamps. AC plug Connection.	Usually unavoidable in certain areas. Occurs when lamps are on and cannot be helped. Try reversing AC plug connections. Occurs only on certain stations due to high voltage power line and cannot be helped in many areas.
Continuous hiss or buzzing interference with broadcast. Becomes louder during stereo.	Incoming signal too weak at ANT terminal.	Erect outdoor FM antenna if only indoor T-type is used. A 5 or 7 element antenna is necessary if you are located at a considerable distance from the broadcasting station.
Occasional sharp buzzing or crackling noise.	Automobile ignition noise. More noticeable on weak signals.	Erect outdoor FM antenna as far away from roads as practicable.
FM Automatic Circuit fails to respond to stereo broadcast.	Incoming signal is exceptionally weak.	Erect an FM outdoor antenna.

RATING

Power Consumption:	22 watts
Dimensions:	W 16-15/16" (430 mm)
	H 5-7/8" (149 mm)
	D 14-13/16" (376 mm)
Weight:	18.7 lbs. (8.5 kg)



© 6432 PRINTED IN JAPAN B50-1513-00 (UM) (T)

Free Manuals Download Website

<http://myh66.com>

<http://usermanuals.us>

<http://www.somanuals.com>

<http://www.4manuals.cc>

<http://www.manual-lib.com>

<http://www.404manual.com>

<http://www.luxmanual.com>

<http://aubethermostatmanual.com>

Golf course search by state

<http://golfingnear.com>

Email search by domain

<http://emailbydomain.com>

Auto manuals search

<http://auto.somanuals.com>

TV manuals search

<http://tv.somanuals.com>