

KENWOOD

COMPACT HI-FI SYSTEM

NV-SERIES

NV-701/NV-301

INSTRUCTION MANUAL

KENWOOD CORPORATION

**This instruction manual is used to describe multiple models listed above.
Model availability and features (functions) may differ depending on the country
and sales area.**



B60-4755-00 (EN)

2 Before applying power

⚠ **Caution :** Read this page carefully to ensure safe operation.

Units are designed for operation as follows.

U.S.A. and Canada AC 120 V only
Australia AC 240 V only

Europe and U.K. AC 230 V only
China AC 220 V only
***Other countries** AC 110-120 / 220-240 V switchable

For the United Kingdom

Factory fitted moulded mains plug

1. The mains plug contains a fuse. For replacement, use only a 13-Amp ASTA-approved (BS1362) fuse.
2. The fuse cover must be refitted when replacing the fuse in the moulded plug.
3. Do not cut off the mains plug from this equipment. If the plug fitted is not suitable for the power points in your home or the cable is too short to reach a power point, then obtain an appropriate safety approved extension lead or adapter, or consult your dealer.

If nonetheless the mains plug is cut off, remove the fuse and dispose of the plug immediately, to avoid a possible shock hazard by inadvertent connection to the mains supply.

IMPORTANT: The wires in the mains lead are colored in accordance with the following code:
 Blue : Neutral
 Brown : Live

Do not connect those leads to the earth terminal of a three-pin plug.

*AC voltage selection (For U.S. military and other selected regions)

The AC voltage selector switch on the rear panel is set to the voltage that prevails in the area to which the unit is shipped. Before connecting the power cord to your AC outlet, make sure that the setting position of this switch matches your line voltage. If not, it must be set to your voltage in accordance with the following direction.

AC voltage selector switch

Move switch lever to match your line voltage with a small screwdriver or other pointed tool.

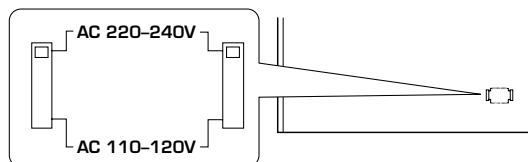

Note:

Our warranty does not cover damage caused by excessive line voltage due to improper setting of the AC voltage selector switch.

Safety precautions

WARNING : TO PREVENT FIRE OR ELECTRIC SHOCK, DO NOT EXPOSE THIS APPLIANCE TO RAIN OR MOISTURE.

	<p>CAUTION RISK OF ELECTRIC SHOCK DO NOT OPEN</p>		<p>CAUTION: TO REDUCE THE RISK OF ELECTRIC SHOCK, DO NOT REMOVE COVER (OR BACK). NO USER-SERVICEABLE PARTS INSIDE. REFER SERVICING TO QUALIFIED SERVICE PERSONNEL.</p>
	<p>THE LIGHTNING FLASH WITH ARROWHEAD SYMBOL, WITHIN AN EQUILATERAL TRIANGLE, IS INTENDED TO ALERT THE USER TO THE PRESENCE OF UNINSULATED "DANGEROUS VOLTAGE" WITHIN THE PRODUCT'S ENCLOSURE THAT MAY BE OF SUFFICIENT MAGNITUDE TO CONSTITUTE A RISK OF ELECTRIC SHOCK TO PERSONS.</p>		
	<p>THE EXCLAMATION POINT WITHIN AN EQUILATERAL TRIANGLE IS INTENDED TO ALERT THE USER TO THE PRESENCE OF IMPORTANT OPERATING AND MAINTENANCE (SERVICING) INSTRUCTIONS IN THE LITERATURE ACCOMPANYING THE APPLIANCE.</p>		

The marking of products using lasers (Except for some areas)





The marking is located on the rear panel and says that the component uses laser beams that have been classified as Class 1. It means that the unit is utilizing laser beams that are of a weaker class. There is no danger of hazardous radiation outside the unit.

Contents

Caution : Read the pages marked  carefully to ensure safe operation.

Preparation section

-  **Before applying power** 2
-  **Safety precautions** 2
- Special features** 4
- System connection** 5
 - Accessories 5
 - Connection of the system accessories 5
 - Connection with other components (optional or commercially-available equipment) 8
- Controls and indicators** 11
 - Main unit 11
 - Display 13
 - Remote control unit (RC-NV301 / RC-NV301E) 14
 - Remote control unit (RC-NV701 / RC-NV701E) 15
- Operation of the remote control unit** 17
- Operation of the MULTI CONTROL setting mode** 18
- Clock adjustment** 19
- Setting up for surround sound (NV-701 only)** 20
 - Setting the configuration of the speaker system 20
 - Setting speaker distances and system volume levels 21
- Setting the audio for connected components (NV-701 only)** 23

Basic section

- Let's have sound** 24
 - Basic operation 24
 - CD Playback 26
 - Tape playback 28
 - Receiving broadcast stations 31
 - CHANNEL SPACE setting (Except for the U.S.A., Canada, U.K., Europe, and Australia) 33
- Let's record** 34
 - Recording onto a tape 34

Application section

- Special playback options for CD** 37
 - Listening in the desired sequence (program playback) 37
 - Repeated playback 39
 - Random playback 41
- R.D.S. (Radio Data System) (For U.K. and Europe)** 42
 - Searching for a desired program type (PTY search) (For U.K. and Europe) 43
- Convenient CD recording** 45
 - Selection of a recording type 45
 - Recording only the desired track (CD ONE TRACK RECORDING) 46
 - Recording an entire CD (CD DIRECT RECORDING) 47
 - Recording programmed tracks (CD PROGRAM RECORDING) 48
 - Recording digital sound tracks (DIGITAL SOURCE RECORDING) (NV-701 only) 49
- Effective sound adjustment** 50
 - Balance adjustment 50
 - Input level adjustment 51
 - Listening to music with the desired sound (NV-701 only) 52
 - Surround modes 52
 - Surround play (NV-701 only) 54
 - Subwoofer level adjustment (NV-701 only) 55
- Remote operation of other components (NV-701 only)** 56
 - Setting up the remote control unit 56
 - Key functions when operating other components 57
- Timer operation** 59
 - Sleep timer 59
 - Timer programming 60

Knowledge section

- Important Items** 63
 - Setup Codes (RC-NV701) 63
 - Setup Codes (RC-NV701E) 64
 - Maintenance 65
 - Reference 65
- Handling of discs and tapes** 66
- In case of difficulty** 67
- Specifications** 71



As an ENERGY STAR® Partner, Kenwood Corporation has determined that this products meets the ENERGY STAR® guidelines for energy efficiency. This product can save energy. Saving energy reduces air pollution and lowers utility bills.

Preparation section

Basic section

Application section

Knowledge section

4 *Special features*

Simple operation of numerous unit functions using MULTI CONTROL setting mode

The MULTICONTROL setting mode gives you control of a number of unit operations including CD program playback and timer programming while using an easy to use menu format.

3-Disc carousel CD player

Three discs can be set. You can enjoy listening to your CDs with program playback, repeat playback, random playback, etc.

Convenient timer functions

Timer programming : Timer playback, AI timer playback, and timer recording can be set.

- AI timer playback : When the unit is turned ON by the timer, the sound level increases gradually.

Sleep timer : Useful when you want to fall asleep while listening to music.

Auto power save

When the power is ON and neither recording nor playback occurs for 30 minutes or more, the power is switched to standby mode automatically.

CD text information display (CD TEXT compatibility)

The text information (disc title and track titles) recorded on CDs can be displayed.

True home theater sound (NV-701 only)

Internal multichannel audio decoding

This unit incorporates internal Dolby Digital and DTS decoding. By connecting a commercially available DVD player to this unit, you can enjoy cinematic quality 5.1-channel surround sound when playing back media encoded in Dolby Digital and DTS formats. This unit's CD player is also compatible with playback of DTS CDs.

Discreet 6-channel input capability

This unit features discreet 6-channel input for connection to a DVD player or an external decoder. This feature allows the flexibility for connection to an external digital audio decoder of a current or future digital audio format.

Remote operation of other components (NV-701 only)

The remote control unit is programmed with the control codes of a number of manufacturers so you can operate the other components in your system.

Discs which can be played with this unit

CD (12 cm, 8 cm), and the audio part of CDV, CD-G, CD-EG and CD-EXTRA.

Use discs that comply with the IEC standard, for example a disc carrying the  marking on the label surface.

Demonstration

When the power supply is restored after a power failure or the power cord is unplugged and then plugged in again during use, this unit automatically starts the demonstration function (display only). During the demonstration, the display changes in sequence but the sound mode does not change.

To switch the demonstration on and off :



Turn the unit to the standby mode and press the MENU(DEMO) key.
Each press of the key switches the demonstration on and off.

Accessories

FM indoor antenna
(1)

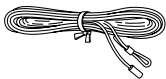

AM loop antenna
(1)



Remote control unit
(1)

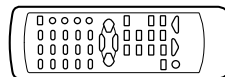

RC-NV301
RC-NV301E
(For NV-301)

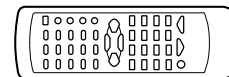

RC-NV701
RC-NV701E
(For NV-701)

Speaker cords
NV-301 (2)
NV-701 (6)



(Speaker cords are provided in the speaker package. Be sure to check that the correct lengths have been provided.)

Batteries (R6/AA)
(2)

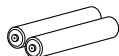

AC plug adaptor (1)

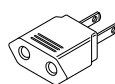

Use to adapt the plug on the power cord to the shape of the wall outlet. (Accessory only for regions where use is necessary.)

Preparation section

Unpacking

Unpack the unit carefully and make sure that all accessories are put aside so they will not be lost. Examine the unit for any possibility of shipping damage. If your unit is damaged or fails to operate, notify your dealer immediately. If your unit was shipped to you directly, notify the shipping company without delay. Only the consignee (the person or company receiving the unit) can file a claim against the carrier for shipping damage.

We recommend that you retain the original carton and packing materials for use should you transport or ship the unit in the future.

Keep this manual handy for future reference.

When unpacking the main unit

Plastic protective adhesives have been applied to the front panel of the main unit to prevent minor scratches to the front panel during shipping. Please remove these adhesives before using this unit.

Connection of the system accessories

CAUTION Note on Connection

Connect the components as shown in the diagrams. Do not plug the power cord into a power outlet until connections are complete. The rear panel configuration varies depending on the models (countries or area).

FM indoor antenna

The accessory antenna is for temporary indoor use only. For stable signal reception we recommend using an outdoor antenna. Remove the indoor antenna if you connect one outdoors.

- ❶ Connect to the antenna terminal.
- ❷ Locate a position providing good reception.
- ❸ Fix the antenna in place.

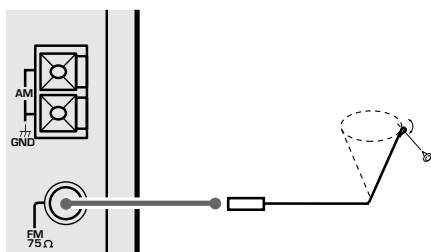

AM loop antenna

The supplied antenna is for indoor use. Place it as far as possible from the main unit, TV sets, speaker cords, and the power cord, and set it in the direction that provides the best reception.

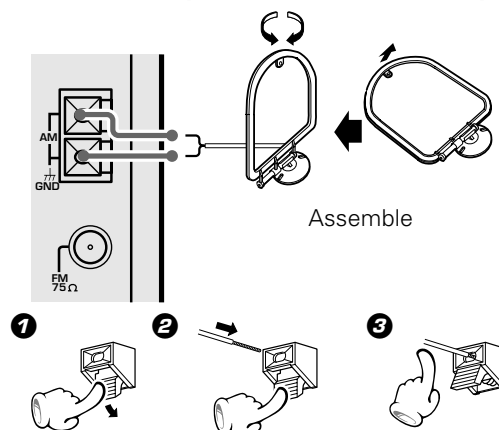

Connecting the speakers

When connecting the speakers, be sure to keep in mind the following points regarding speaker connection.

- Never short-circuit the "+" and "-" speaker cords.
- If the left and right speaker connections or the "+" and "-" polarity are inverted, the sound will be unnatural with unclear positioning of musical instruments, etc. Be sure to connect the transparent cord and striped cord of the speaker cable to the matching terminals on the speakers and the main unit.
- (NV-701 only) When all connections are complete, be sure to perform the "Setting up for surround sound" operations to ensure the best possible surround sound from your system. → 20

Main Unit

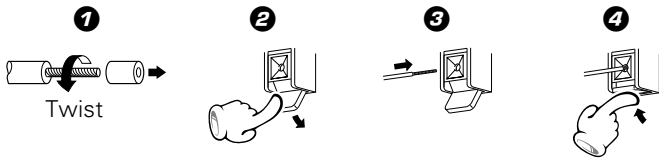

Speaker Unit

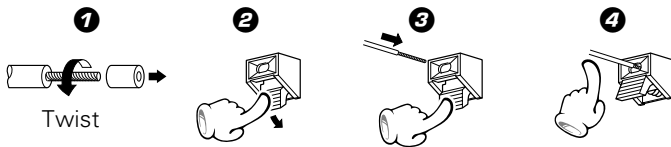

Front speakers (NV-301 only)

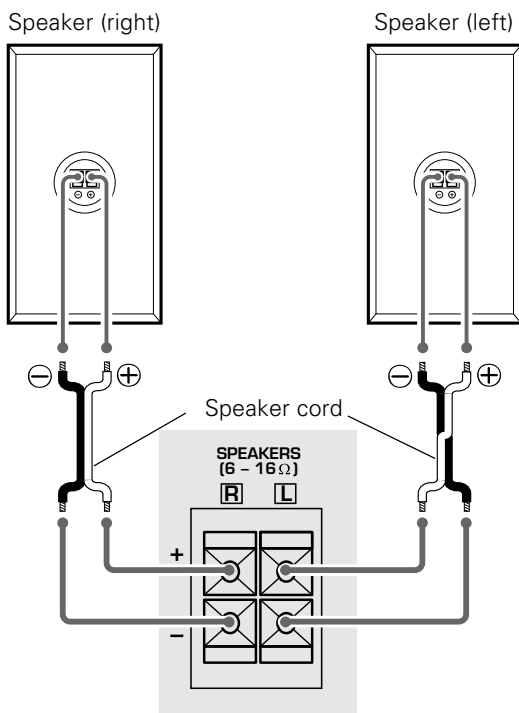

Surround speaker system (NV-701 only)

Speaker cords are supplied with this unit. Use the 2 m (6 ft.) speaker cords for the front and center speakers, the 8 m (26 ft.) speaker cords for the surround speakers, and the 3 m (10 ft.) speaker cord for the subwoofer. Be sure to match the colored terminals on the speakers with the similarly labeled terminals on the main unit as follows:

- Front Right speaker: RED
- Front Left speaker: BLUE
- Center speaker: GREEN
- Surround Right speaker: ORANGE
- Surround Left speaker: GRAY
- Subwoofer: BROWN

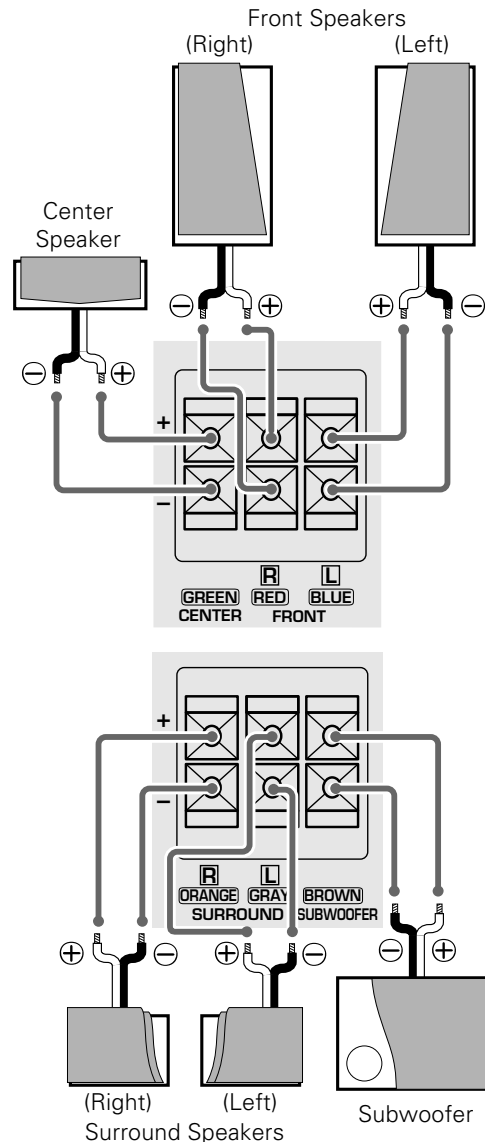

Speaker placement in a multichannel home theater setup

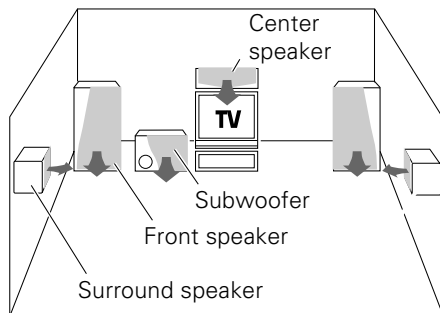

Front speakers: Place to the front left and right of the listening position at equal distances from both the unit and the listening position. Front speakers are required for all surround modes.

Center speaker: Place front and center. This speaker stabilizes the sound image and helps recreate more natural sound motion.

Surround (rear) speakers: Place to the direct left and right, or slightly behind, the listening position at even heights approximately 1 meter (3.5 ft.) above the ears of the listeners. These speakers recreate rear sound motion and atmosphere, and are required for surround playback.

Subwoofer: Reproduces deep bass and other low frequency sounds.

By performing the "Surround Options" setup operations, this unit makes automatic adjustments to account for the way the speakers have been set up in order to deliver the best possible surround sound. 

CAUTION

(For U.S.A., U.S.-Military and Canada)

Be sure to adhere to the following or proper ventilation will be blocked causing damage or fire hazard.

- Do not place any objects impairing heat radiation onto the top of this unit.

Speaker and TV installation

The magnet in the speakers may cause color irregularity if set on the TV. If this occurs, place the speaker farther away from the TV set.

Malfunction of the microcomputer

If operation is not possible or an erroneous display appears even though all connections have been made properly, reset the microcomputer. Refer to "In case of difficulty". 



- Be sure to insert all connection cords securely. If connections are not secure, the sound may not be produced or noise may interfere.**
- Before plugging or unplugging a connection cord, be sure to unplug the power cord from the wall AC outlet. If connection cords are plugged or unplugged with the power cord left plugged in, malfunction or damage may result.**

CAUTION

Be sure to adhere to the following or proper ventilation will be blocked causing damage or fire hazard.

- Do not place any objects impairing heat radiation onto the top of unit.
- Do not place a speaker or any other object next to the ventilation holes on the left side of the main unit. For proper ventilation, be sure to provide sufficient space on the left side of the main unit.
- Leave a space around the unit (from the largest outside dimension including projection) equal or greater than, shown below.

Top panel : 50 cm

Side panel : 10 cm

Back panel : 10 cm

Connection with other components (optional or commercially-available equipment)

CAUTION Note on Connection

Connect the components as shown in the diagrams. Do not plug the power cord into a power outlet until connections are complete. The rear panel configuration varies depending on the models (countries or area).



When an external system component is connected, please read the instruction manual of the component as well.

MD recorder, DVD player, VCR, or analog turntable (NV-301 only)

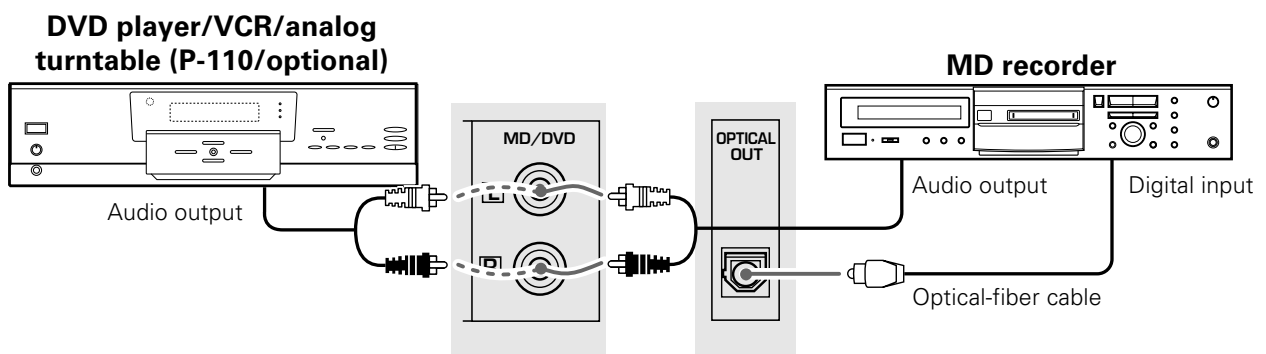

When making connections

- Make connections to the MD/DVD jacks using a commercially available audio cable.
- Be sure to match the colors of the plugs with the colors of the jacks for correct right (red) and left (white) channel matching.
- Make connections to the OPTICAL OUT optical jack using a commercially available digital optical cable to an MD recorder or other digital recording device for digital recording of CDs played on this unit.

Subwoofer (NV-301 only)

Connect a subwoofer (optional) for powerful low frequency sounds.

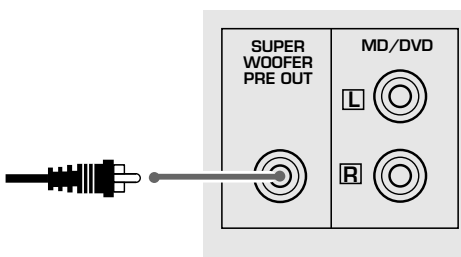

FM outdoor antenna

Lead the 75Ω coaxial cable connected to the FM outdoor antenna into the room and connect it to the FM 75Ω terminal.

Use a commercially-available antenna adapter (a small-sized model).

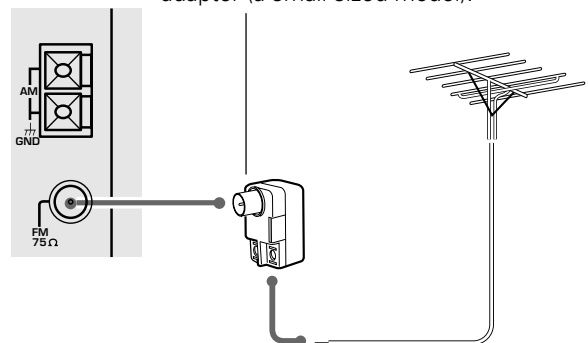

VCR, MD/CD recorder, or analog turntable (NV-701 only)

The VIDEO 1 jacks can be used for connection of a VCR or similar component that features audio and video input and output capability.

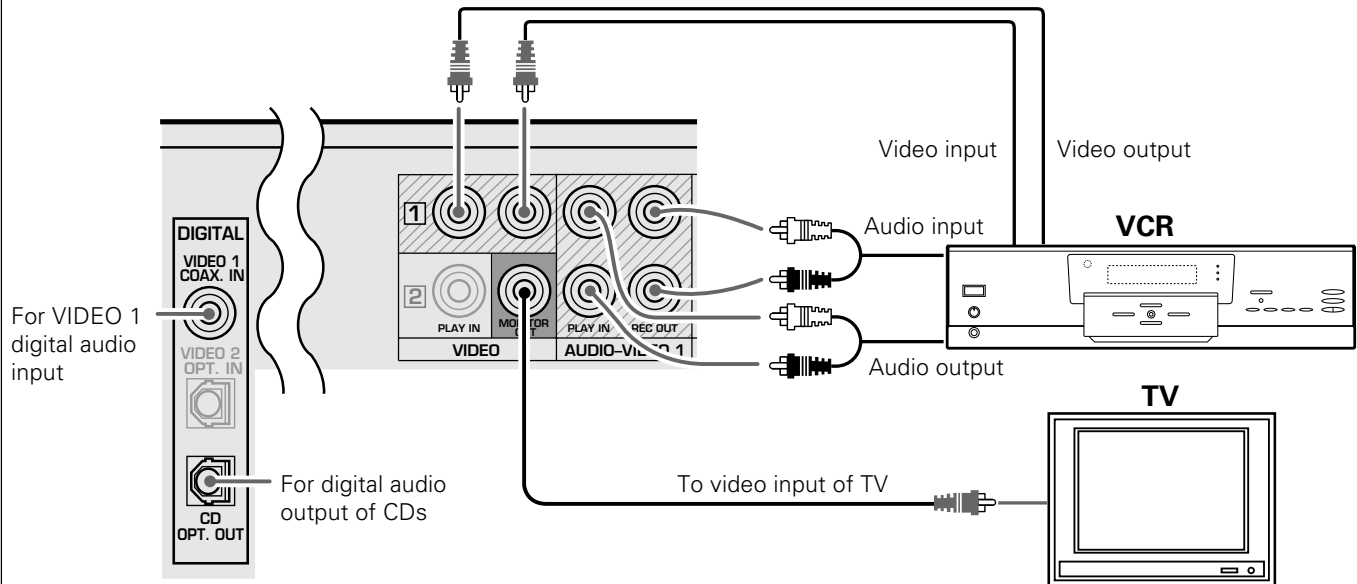

When making connections to a VCR:

- For complete video connection, use commercially available video cables to make connections from the video output jack on the VCR to the VIDEO 1 PLAY IN jack, from the video input jack on the VCR to the VIDEO 1 output jack (located above the MONITOR OUT jack), and from the VIDEO MONITOR OUT jack to a TV or monitor.
- Make audio connections from the audio output jacks on the VCR to the AUDIO – VIDEO 1 PLAY IN jacks and from the audio input jacks on the VCR to the AUDIO – VIDEO 1 REC OUT jacks using commercially available audio cables.
- Be sure to match the colors of the plugs with the colors of the jacks for correct right (red) and left (white) channel matching.
- For greatly improved sound, make connections to the DIGITAL VIDEO 1 COAX. IN jack using a commercially available coaxial cable if the component you are making connections to features digital audio output from a coaxial jack.

When making connections to an MD or CD recorder:

- Make audio connections from the audio output jacks on the MD or CD recorder to the AUDIO – VIDEO 1 PLAY IN jacks and from the audio input jacks on the MD or CD recorder to the AUDIO – VIDEO 1 REC OUT jacks using commercially available audio cables.
- Do not make any connections to the VIDEO 1 PLAY IN and output jacks.
- If digital connections are made to the DIGITAL VIDEO 1 COAX. IN jack, it is also recommended to make connections to the analog AUDIO – VIDEO 1 PLAY IN jacks.
- Make connections from the DIGITAL CD OPT. OUT jack to the corresponding input jack on the MD or CD recorder for digital recording of CDs played on this unit.

DVD player (NV-701 only)

The VIDEO 2 jacks can be used for connection of a DVD player or similar component that features audio and/or video output capability.

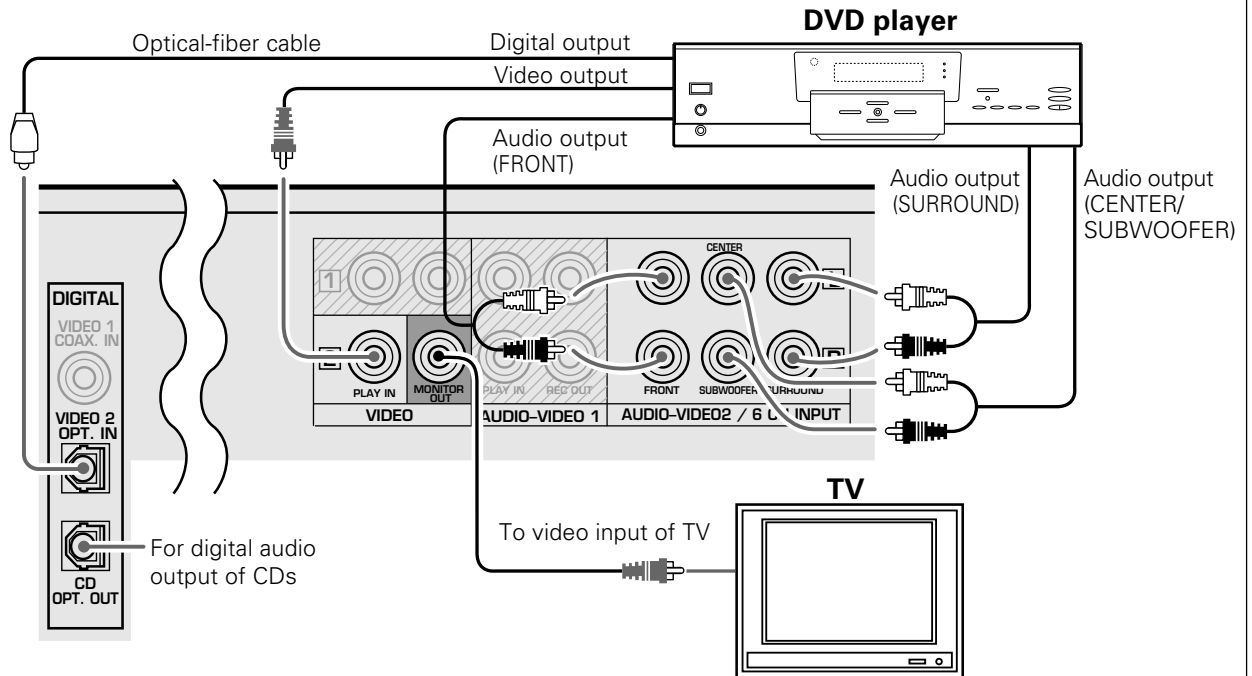

When making audio connections to a DVD player or similar component:

- For complete video connection, use commercially available video cables to make connections from the video output jack on the DVD player to the VIDEO 2 PLAY IN jack, and from the VIDEO MONITOR OUT jack to a TV or monitor.
- When making analog connections from a DVD player that only features right and left channel stereo output, make connections to the AUDIO – VIDEO 2/6 CH INPUT FRONT R and L jacks respectively. When making this type of connection, do not make connections to the CENTER, SUBWOOFER, or SURROUND R/L jacks.
- When you are making connections from a DVD player that features internal decoding or when the digital signal is routed through a decoder for full 6 channel discrete audio output, make connections from the output jacks on the DVD player or decoder to the corresponding AUDIO – VIDEO 2/6 CH INPUT jacks .
- For greatly improved sound, make connections to the DIGITAL VIDEO 2 OPT. IN jack using a commercially available optical-fiber cable.
- If digital connections are made to the DIGITAL VIDEO 2 OPT. IN jack, it is also recommended to make connections to the appropriate analog AUDIO – VIDEO 2/6 CH INPUT jacks.

About the DIGITAL jacks on this unit

When using the DIGITAL OPT. (optical) jacks, remove the cap and plug in the optical-fiber cable.

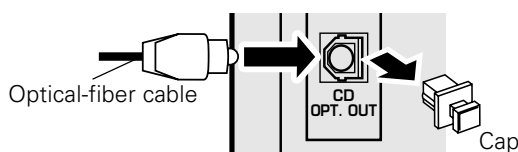

- Insert the optical-fiber cable straight into the connector until it clicks.
- Be sure to attach the protection cap when the connector is not used.
- Never bend or bundle up the optical-fiber cable.

(NV-701 only) When using the DIGITAL VIDEO 1 COAX. IN jack, insert the coaxial cable firmly into the jack.

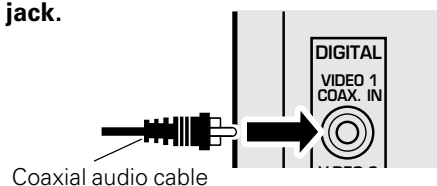

Main unit

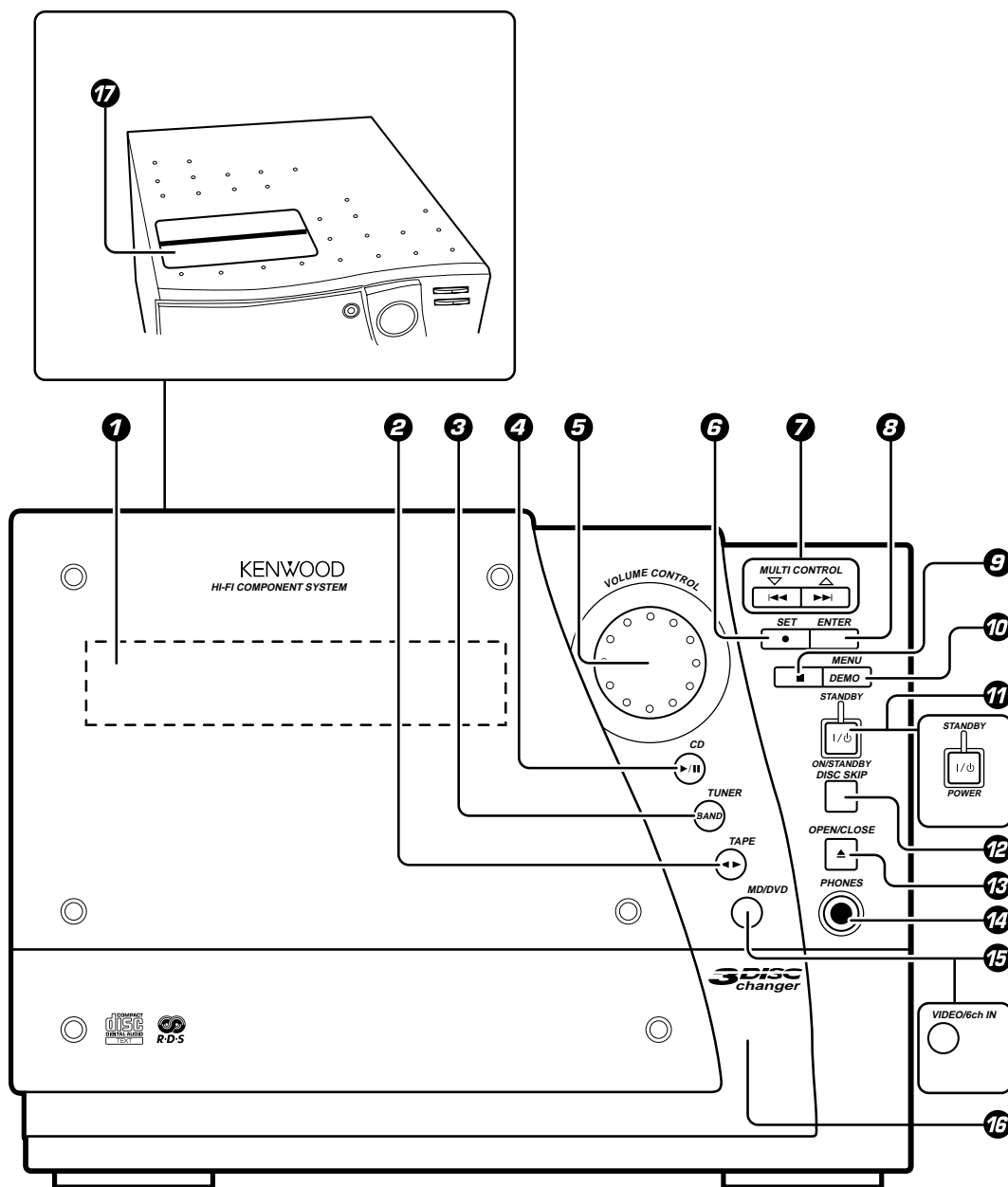

- 1 Display** → 13
- 2 TAPE (◀▶) key** → 28
Press to select the cassette deck and start playback.
- 3 TUNER (BAND) key** → 31
Press to select the tuner and switch the receiving band.
- 4 CD (▶/II) key** → 26
Press to select the CD input and start playback.
- 5 VOLUME CONTROL knob** → 24
Use to adjust the volume.
- 6 SET (●) key** → 18 → 35
Press to set items when using the MULTI CONTROL setting mode.
When the TAPE input is selected, press to start recording. Pressing this key while recording stops it after creating a non-recorded space (blank) of about 4 seconds.
- 7 MULTI CONTROL (◀◀/▶▶) keys**
→ 18 → 27 → 29 → 31
Use these keys to select optimum modes according to the desired operations.
When the CD input is selected, these keys are used to skip tracks.
When the TUNER input is selected, these keys are used to select a station.
When the TAPE input is selected, these keys are used to fast forward or rewind the tape.
- 8 ENTER key** → 18
Press to enter settings and perform functions when using the MULTI CONTROL setting mode.
When power is in the standby mode:
Used for displaying the time. (If this key is pressed while a timer operation is set, the timer icon and the timer reservation setting mode appear in the display, then the display returns to the previous condition.)

- 9 ■ (stop) key** → 27 → 29
Operation key for the CD player and cassette deck.
- 10 MENU (DEMO) key** → 4 → 18
Switches the displayed information. Press to switch the MULTI CONTROL setting mode on and off.
When power is in the standby mode:
Use to turn the demonstration on and off.
- 11 | / ⏻ (ON/STANDBY) key** → 24
| / ⏻ (POWER) key (For U.S.A.)
Press to turn the power ON and put in STANDBY.
STANDBY indicator
The indicator lights up when the power is set to the standby mode.
- 12 DISC SKIP key** → 26 → 27
The disc for playback (or recording) is selected. This is also used to rotate the disc tray when loading CDs onto the disc tray.
- 13 OPEN/CLOSE (▲) key** → 26
The disc tray is opened and closed.
- 14 PHONES jack** → 24
For connection of headphones (optional).
- 15 MD/DVD key (NV-301 only)** → 24
Press to select input from the component connected to the MD/DVD jacks on the rear panel.
VIDEO/6ch IN key (NV-701 only)
Press to switch between selection of the components connected to the VIDEO 1 and VIDEO 2 related jacks on the rear panel.
- 16 Disc tray** → 26
Three discs can be stored.
- 17 Cassette holder** → 28
Press **PUSH OPEN** to load or remove a tape.

Display

The displays given in this manual are approximations only. They may differ from what actually appears on the display.

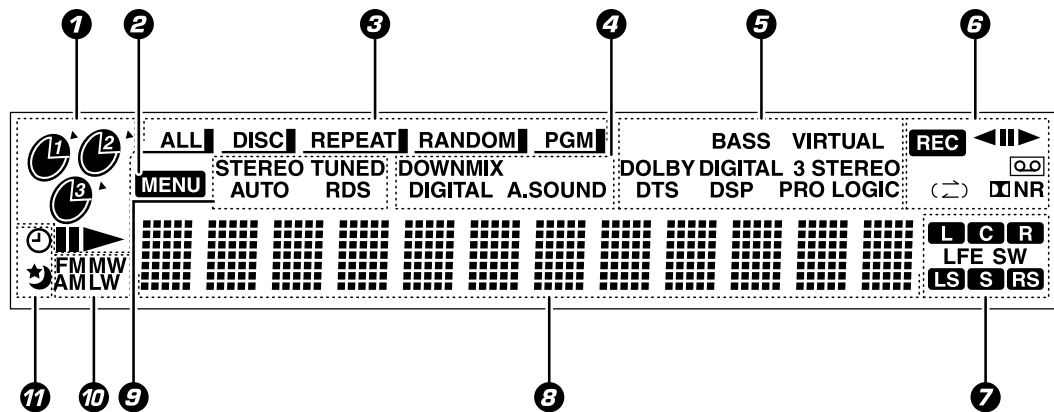

1 CD player indicators

Indicate which disc trays contain discs, which disc is currently selected as well as play and pause indications.

2 MENU indicator

The unit is in the MULTI CONTROL setting mode.

3 CD playback mode indicators

ALL: ALL disc playback is selected.

DISC: Single disc playback is selected.

REPEAT: Repeat playback is being performed.

PGM: Program playback is being performed.

RANDOM: Random playback is being performed.

4 Audio input selection indicators (NV-701 only)

DOWNMIX: A multichannel audio source is being downmixed for stereo output.

DIGITAL: The digital audio input from a connected component is selected.

A.SOUND: The audio signal format from a connected component is automatically selected.

5 Sound mode indicators

The following indicators light for NV-301 only

BASS: The bass is being emphasized using the Exbass function.

The following indicators light for NV-701 only

VIRTUAL: The Virtual surround mode is selected.

DOLBY DIGITAL: Dolby Digital processing is selected.

3 STEREO: The 3 STEREO surround mode is selected.

DTS: DTS processing is selected.

DSP: One of this unit's DSP modes is selected.

PRO LOGIC: A Dolby Pro Logic source is being played back.

6 Cassette deck-related indicators

Indicate the play/record status, the reverse mode, the tape playback direction, and whether Dolby NR (noise reduction) is being used.

7 Multichannel audio indicators (NV-701 only)

Indicate the active audio channels present in a source or the type of playback being performed.

L: Front left channel

C: Center surround channel

R: Front right channel

LFE: Low Frequency Effects (included in 5.1 channel sound tracks)

SW: Subwoofer channel

LS: Left surround channel

S: Monaural rear surround channel

RS: Right surround channel

8 Character information display

Displays the MULTI CONTROL setting items, input selection, tuner frequency, volume level, etc.

9 Tuner broadcast indicators

Depending on the region, not all indicators appear.

STEREO: The broadcast is being received in stereo.

TUNED: A station has been preset in memory.

AUTO: Automatic preset tuning is being performed.

RDS: (For U.K. and Europe) A station that features RDS functions is tuned.

10 Tuner band indicators

Indicates the currently selected broadcast band.

Depending on the region, not all band indicators appear.

11 Timer indicators

Indicate a timer reservation has been set.

Remote control unit (RC-NV301 / RC-NV301E)

The keys on the remote control unit with the same names as on the main unit have the same function as the keys on the main unit.

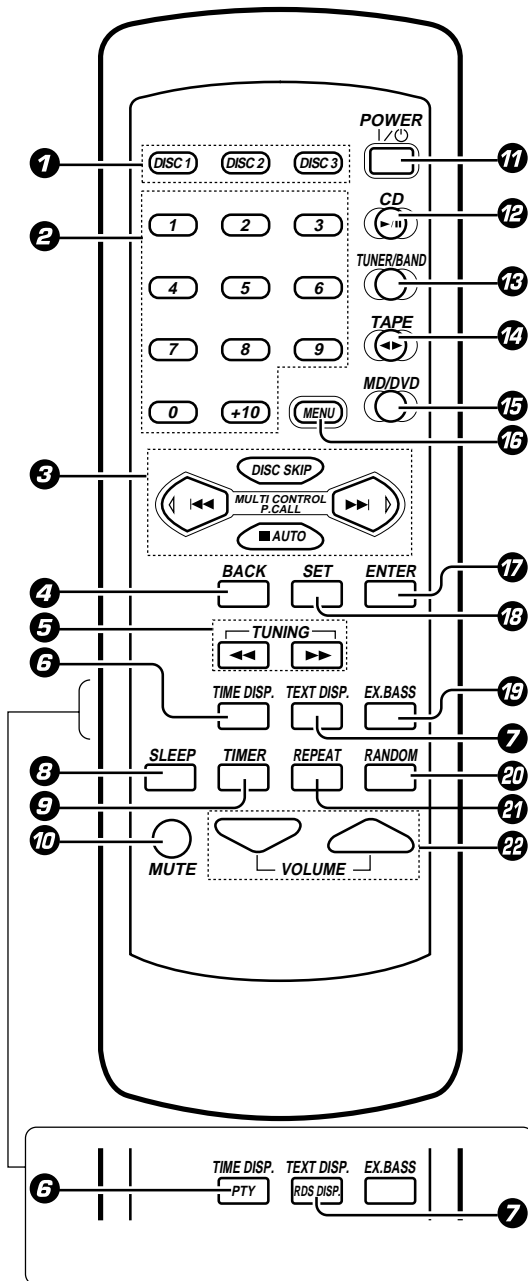

- 1 DISC SELECTOR keys** → 26 → 27
Use to select the disc for playback (or recording).
- 2 Numeric keys** → 27
Used as number keys when the input is CD or TUNER.
- 3 MULTI CONTROL keys** → 18 → 27 → 29 → 31
P.CALL |◀◀/▶▶| (skip) keys → 27 → 31
DISC SKIP key → 26 → 27
■/AUTO key → 27 → 29 → 31
When the CD or TAPE input is selected, press to stop playback.
When the TUNER input is selected, press to select automatic tuning.

- 4 BACK key** → 18
Press in the MULTI CONTROL setting mode to return to a previous step.
- 5 TUNING (◀◀/▶▶) keys** → 27 → 32
When the CD input is selected, press to fast forward or backward the disc.
When the TUNER input is selected, press to tune in a station.
- 6 TIME DISP. key** → 27
Press to switch the time information on the CD player unit.
- PTY key (For U.K. and Europe)** → 43
This is used to specify the program type when searching for a station.
- 7 TEXT DISP. key** → 45
Press to switch the text information recorded in a CD TEXT disc.
- RDS DISP. key (For U.K. and Europe)** → 42
The display contents are switched during reception of RDS broadcasts.
- 8 SLEEP key** → 59
Press to set the sleep timer.
- 9 TIMER key** → 60
Press to set the timer programming mode.
- 10 MUTE key** → 25
This is used to mute the sound temporarily.
- 11 POWER (| / ⏻) key** → 24
- 12 CD (▶ / ⏸) key** → 26
- 13 TUNER/BAND key** → 31
- 14 TAPE (◀ ▶) key** → 28
- 15 MD/DVD key** → 24
- 16 MENU key** → 18
- 17 ENTER key** → 18
- 18 SET key** → 18 → 34
- 19 EX. BASS key** → 25
Press to enhance the bass during audio playback.
- 20 RANDOM key** → 41
For CD playback, switching is executed between random playback and normal playback.
- 21 REPEAT key** → 39
Used for repeated playback of a CD.
- 22 VOLUME keys** → 24
Use to adjust the volume.

Remote control unit (RC-NV701 / RC-NV701E)

The keys on the remote control unit with the same names as on the main unit have the same function as the keys on the main unit.

Functions listed in brackets [] can be set up to be used with the components you have connected to this unit.

For more details, see "Remote operation of other components" — 56

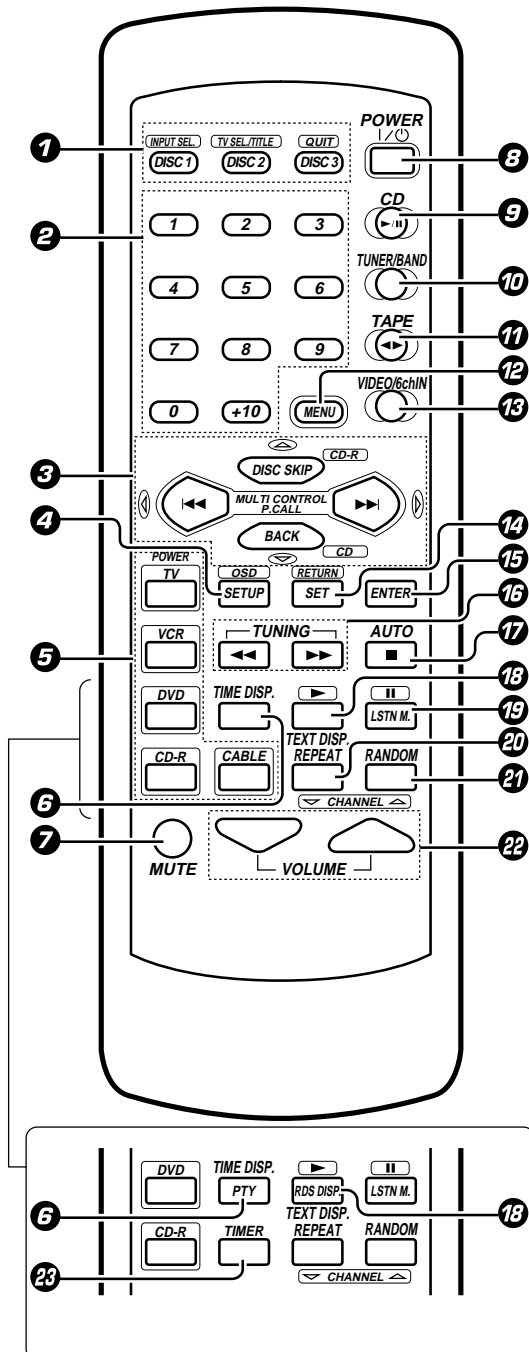

1 DISC SELECTOR keys — 26 — 27

Use to select the disc for playback (or recording).

[INPUT SEL]

Use to select/change the input on a TV, VCR, etc.

[TV SEL/TITLE]

Use to change the TV to the TV mode. Use to display the title menu when controlling a DVD player.

[QUIT]

Use to quit operation of a TV, VCR, DVD player, CD recorder, etc.

2 Numeric keys — 27

Used as number keys when the input is CD or TUNER.

[Numeric keys]

Use to enter numbers for use with a TV, VCR, DVD player, CD recorder, etc.

3 MULTI CONTROL keys — 18 — 27 — 29 — 31

P.CALL ◀◀/▶▶ (skip) keys — 27 — 31

[Skip tracks/ ◀/▶ cursor control]

Use to skip through tracks on a CD recorder or navigate right and left on a DVD player menu screen.

DISC SKIP key — 26 — 27

[CD-R/▲ cursor control]

Use to select the CDR functions of a CD recorder or navigate up on a DVD player menu screen.

BACK key — 18

Press in the MULTI CONTROL setting mode to return to a previous step.

[CD/▼ cursor control]

Use to select the CD functions of a CD recorder or navigate down on a DVD player menu screen.

4 SETUP key — 56

Press to set up the remote control unit to control other components.

[OSD]

Use to open the setup menu of a DVD player, etc.

5 [TV, VCR, DVD, CD-R source power keys] — 56

Use to switch the power of your other components on and off. There are separate keys that can be set up for control of each component.

[CABLE power key] (For U.S.A.)

Use to switch the cable box on and off.

6 TIME DISP. key — 27

Press to switch the time information on the CD player unit.

PTY key (For U.K. and Europe) — 43

This is used to specify the program type when searching for a station.

- 7 MUTE key** → 25
This is used to mute the sound temporarily.
- 8 POWER (I / ⏻) key** → 24
- 9 CD (▶/⏸) key** → 26
- 10 TUNER/BAND key** → 31
- 11 TAPE (◀▶) key** → 28
- 12 MENU key** → 18
[MENU]
Use to display the menu screen when using a DVD player, etc.
- 13 VIDEO/6ch IN key** → 24
- 14 SET key** → 18 → 35
[RETURN]
Use to return to a previous screen on DVD player menu screen.
- 15 ENTER key** → 18
[ENTER/Play]
Use to enter settings in a TV or DVD player, etc., or also start playback of a VCR, CD recorder, etc.
- 16 TUNING (◀◀/▶▶) keys** → 27 → 32
When the CD input is selected, press to fast forward or backward the disc.
When the TUNER input is selected, press to tune in a station.
[Fast forward and reverse]
Use to perform fast forward and reverse scanning with a VCR, DVD player, or CD recorder.
- 17 AUTO (■) key** → 27 → 29 → 31
When the CD or TAPE input is selected, press to stop playback.
When the TUNER input is selected, press to select automatic preset tuning.
[Stop]
Use to stop playback of a VCR, DVD player, or CD recorder.
- 18 TEXT DISP. key** → 45
Press to switch the text information recorded in a CD TEXT disc.
- RDS DISP. key (For U.K. and Europe)** → 42
The display contents are switched during reception of RDS broadcasts.
[▶] (play)
Use to start playback of a VCR, DVD player, or CD recorder.
- 19 LSTN M. key** → 54
Press to select an audio effect.
[II] (pause)
Use to pause playback of a VCR, DVD player, or CD recorder.
- 20 REPEAT key** → 39
Used for repeated playback of a CD.
[CHANNEL ▼]
Use to select lower channel selections when controlling a TV, VCR, etc.
- 21 RANDOM key** → 41
For CD playback, switching is executed between random playback and normal playback.
[CHANNEL ▲]
Use to select higher channel selections when controlling a TV, VCR, etc.
- 22 VOLUME keys** → 24
[volume]
Use to control the volume of a TV, etc.
- 23 TIMER key (For U.K. and Europe)** → 60
Press to set the timer programming mode.

Loading batteries

① Remove the cover.

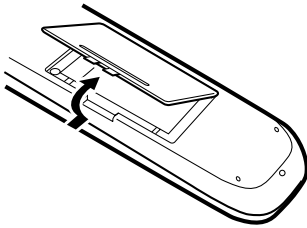

② Insert batteries.

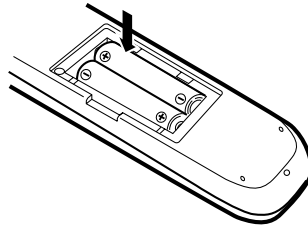

③ Close the cover.

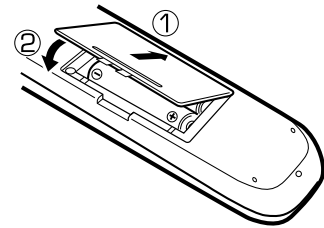

- Insert two R6 ("AA"-size) batteries following the polarity indications.

Operation

Plug the power cord into the mains power outlet and press the **POWER** (I / ⏻) key of the remote control unit to turn the power ON. After the power has been turned ON, press the desired key.

To put the power in standby, press the **POWER** (I / ⏻) key again. The power mode enters the standby mode and the **STANDBY** indicator lights up.

- When pressing more than one remote control key successively, press the keys securely and leave an interval of 1 second or more between the key presses.

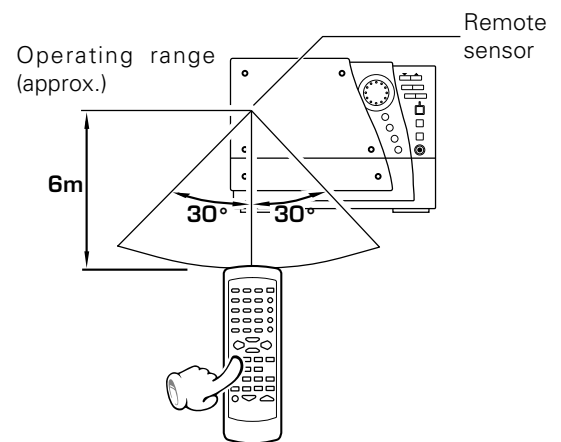

1. The provided batteries are intended for use in operation checking, and their service life may be short.
2. When the remote controllable distance becomes short, replace both of the batteries with new ones.
3. If direct sunlight or the light of a high-frequency fluorescent lamp (inverter type, etc.) is incident to the remote sensor, malfunction may occur. In such a case, change the installation position to avoid malfunction.

Operation of the MULTI CONTROL setting mode

The MULTI CONTROL keys make it possible to perform a number of functions in a simple procedure. When the MENU key is pressed, items appear in the display according to the MULTI CONTROL key operation, so you can select the desired mode more intuitively. You can also use the $\leftarrow\leftarrow\rightarrow\rightarrow$ keys on the remote control unit in the same manner as the MULTI CONTROL keys on the main unit.

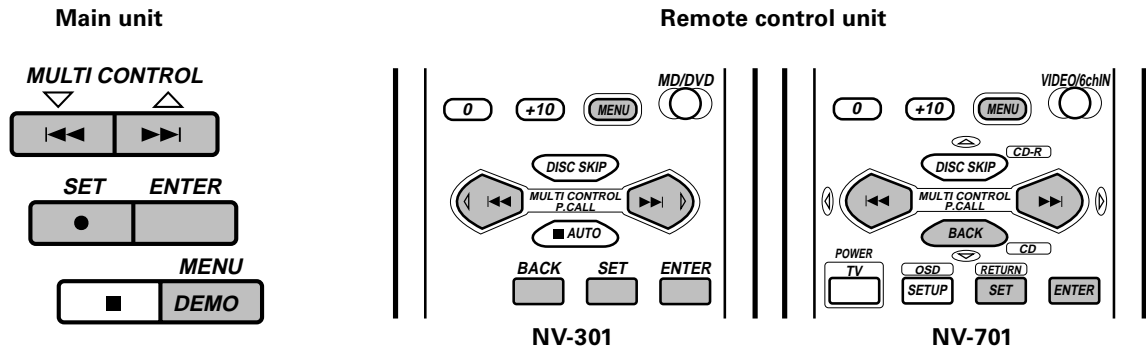

MULTI CONTROL key operation

- ❶ Press the MENU key to enter the MULTI CONTROL setting mode.
- ❷ Select an operation mode by pressing the MULTI CONTROL keys repeatedly.
- ❸ Set items by pressing the SET and ENTER keys as described for each item.

Display examples

The following items can be selected by pressing the MULTI CONTROL keys.

- "CD Program Play" (This item only appears when CD input is selected and playback is stopped.)
- "Recording Options" (This item only appears when a tape is in the tape holder, and does not appear when TAPE input is selected.)
- "Tape Options"
- "Audio Options"
- "Clock Options"
- "Surround Options" (NV-701 only)

- To cancel the MULTI CONTROL setting mode, press the **MENU** key again.
- Press the **BACK** key on the remote control unit to return to the previous step and restart operation from there. (The **BACK** key is inoperative once the message "Press "ENTER" to ---" has been scrolled.)
- Keys on the remote control unit that have the same name as keys on the main unit perform the same functions.
- Depending on the source selected, some items may not be displayed.

The volume control can be used to control the current function while in the MULTI CONTROL setting mode.

This unit incorporates a clock function. It is necessary to set the correct time before using the timer functions. The time can be displayed only while the power is in standby.

1 Select "Clock Options".

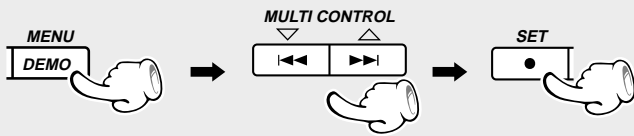

2 Select "Adjust Time".

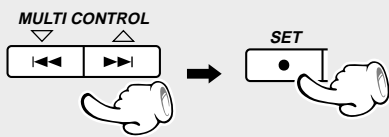

3 Adjust the hour.

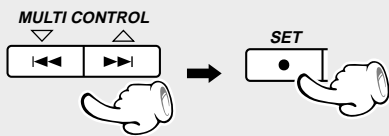

To decrease the figure To increase the figure

4 Adjust the minute.

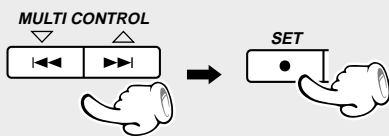

To decrease the figure To increase the figure

5 Start the clock.



To display the time

(In standby mode or when the MD/DVD (NV-301 only) or VIDEO/6ch IN (NV-701 only) input is selected.)



(Displayed for approximately 5 seconds)

The following items can be selected by pressing the MULTI CONTROL keys repeatedly.

- ("CD Program Play")
- ("Recording Options")
- "Tape Options"
- "Audio Options"
- **"Clock Options"**
- "Surround Options" (NV-701 only)

← "Clock Options" is scrolled in the display



The following items can be selected by pressing the MULTI CONTROL keys repeatedly.

- "Sleep Timer"
- **"Adjust Time"**
- "Timer Play"
- "Auto Power Save"

Example: Setting the time to 8:45 in the morning



(For U.K. and Europe) 0 ↔ 1 ↔ 2 ... 13 ↔ 14 ... ↔ 0 ...
 (Other countries) AM12 ↔ AM1 ↔ AM2 ...
 PM1 ↔ PM2 ... ↔ AM12 ...

- The time display starts to blink.
- Press the **SET** key. The hour is entered and the minute display starts to blink.



(For U.K. and Europe) (Other countries)

00 ↔ 01 ↔ 02 ... 59 ↔ 00 ↔ 01 ...

- Press the **BACK** key to return to the previous step and restart operation from there.
- To set the time precisely, press the **ENTER** key at the same moment as a time announcement.

- The clock is reset and the clock display blinks if the power cord has been unplugged from the AC power outlet and plugged in again, or after a power failure. In this case, set the time again.

Once you have completed setting up your speakers, make sure to complete the following speaker settings to obtain and enjoy the best possible surround sound possible from this system.

Setting the configuration of the speaker system

A full surround speaker system is supplied with the NV-701, and the factory settings have been set up according to the specifications of the supplied speakers. However, if you do not connect all the speakers or use different speakers, change the settings as needed to ensure the best possible surround sound for your system.



If you have connected all of the supplied speakers as described on page 6, it is not necessary to perform the procedure on this page. If this is the case, proceed to "Setting speaker distances and system volume levels" on the following page.

1 Select "Surround Options".

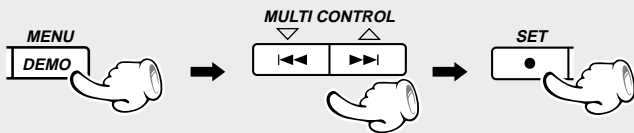

2 Select "Speaker Selection".

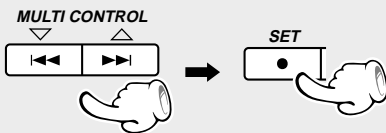

3 Set the size (or presence) of the speakers.

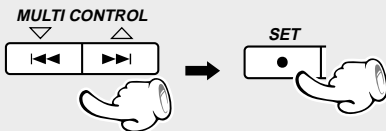

4 Complete and save the settings.



The following items can be selected by pressing the MULTI CONTROL keys repeatedly.

- ("CD Program Play")
- ("Recording Options")
- "Tape Options"
- "Audio Options"
- "Clock Options"
- **"Surround Options" (NV-701 only)**

← "Surround Options" is scrolled in the display

Surround Opt

The following items can be selected by pressing the MULTI CONTROL keys repeatedly.

- "Speakers Distance"
- "Input Mode"
- **"Speaker Selection"**

← "Speaker Selection" is scrolled in the display

Speaker Sele

The following items can be set for each speaker by pressing the MULTI CONTROL keys repeatedly.

- Set "Subwoofer" to establish whether a subwoofer is connected or not.
 - "Yes" (factory setting)
 - "No"
- Set the size of the "Front" speakers. (If "No" is set for the "Subwoofer", the "Front" speaker setting is skipped.)
 - "Normal" (factory setting)
 - "Large"
- Set the size of the "Center" speaker.
 - "Normal" (factory setting)
 - "Large"
 - "No" (no center speaker is connected)
- Set the size of the "Surround" speakers.
 - "Normal" (factory setting)
 - "Large"
 - "No" (no surround speakers are connected)

Setting speaker distances and system volume levels

Set the speaker distances and levels accurately for the best possible delivery of sound when listening to multichannel sources or when applying a digital soundfield to a stereo source.

1 Select "Surround Options".

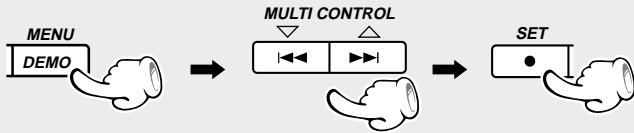

2 Select "Speakers Distance".

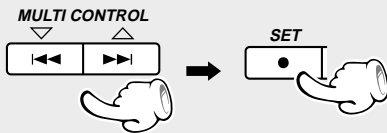

3 Set the distance to the speakers.

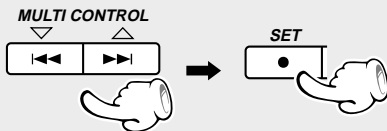

To decrease the distance To increase the distance

The following items can be selected by pressing the MULTI CONTROL keys repeatedly.

- ("CD Program Play")
- ("Recording Options")
- "Tape Options"
- "Audio Options"
- "Clock Options"
- "Surround Options" (NV-701 only)

← "Surround Options" is scrolled in the display

Surround Opt

The following items can be selected by pressing the MULTI CONTROL keys repeatedly.

- "Speakers Distance"
- "Input Mode"
- "Speaker Selection"

← "Speakers Distance" is scrolled in the display

Speakers Dis

Use the MULTI CONTROL keys to set the distance and SET to proceed to the next setting. The speaker channels that the distance is being set for flash in the display.

Front speakers

Front "R" and "L" indicators flash

1ft 0.3m

- Set the distance to the center speaker and surround speakers in the same way.
- The adjustable range for all of the speakers is 1 to 30 ft. (0.3 to 10 m) in 1 ft. (0.3 m) steps.
- When the distance settings are complete, set the volume levels.

Continued on next page...

4 Turn on the test tone.

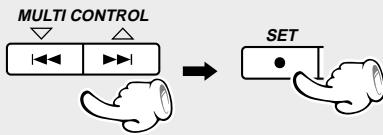

5 Set the speaker levels.

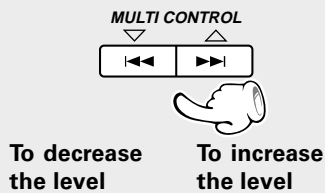

6 Complete and save the settings.



The test tone can be turned on and off by pressing the **MULTI CONTROL** keys repeatedly.

- ▶ "Test ON"
- ▶ "Test OFF"

- The test tone is output from all of the speakers in the system in the following order:

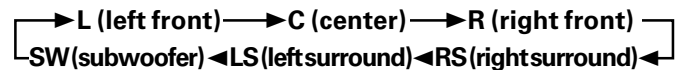

- While listening to the test tone, use the **MULTI CONTROL** keys to adjust the volume levels of each channel when the channel name is displayed. The test tone continues to be output from the selected channel while adjustments are being made. If no adjustments are made for 2 seconds, the test tone resumes the cycle of speaker channels.
- Adjust all of the speakers so that they sound the same from the listening position.
- Because the subwoofer outputs extremely low frequencies, the volume may sound lower with respect to the other speakers.

Once you are through adjusting the levels of the speakers, press the **SET** key to end the test tone and conclude adjustments.

← "Press "ENTER" to save" is scrolled in the display

Press "ENTER"

Press the **ENTER** key to save the settings.

There are different types of audio connections available with this unit depending on what type of component you are making connections to. Select the type of audio input that best reflects the type of connections you have made to external components.

1 Select "Surround Options".

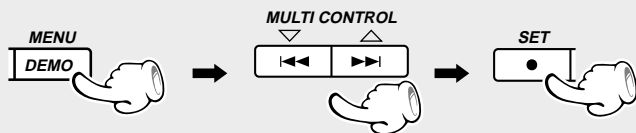

2 Select "Input Mode".

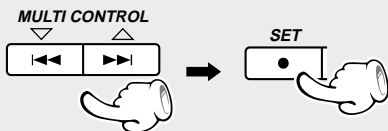

3 Select the input.

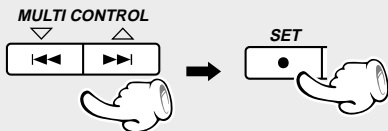

4 Set the input mode.

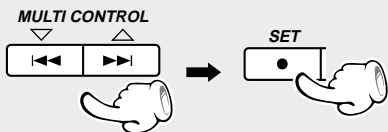

5 Save the settings.



The following items can be selected by pressing the MULTI CONTROL keys repeatedly.

- ("CD Program Play")
- ("Recording Options")
- "Tape Options"
- "Audio Options"
- "Clock Options"
- "Surround Options" (NV-701 only)

← "Surround Options" is scrolled in the display

Surround Opt

The following items can be selected by pressing the MULTI CONTROL keys repeatedly.

- "Speakers Distance"
- "Input Mode"
- "Speaker Selection"

← "Input Mode" is scrolled in the display

Input Mode

The following items can be selected by pressing the MULTI CONTROL keys repeatedly.

- "VIDEO1"
- "VIDEO2"

• The input setting is stored independently for each input. If you have made connections to components using both VIDEO 1 and VIDEO 2 input jacks, be sure to perform this procedure for each component.

The following items can be selected by pressing the MULTI CONTROL keys repeatedly.

- "D – Auto" (Automatic digital signal selection)
- "D – Manual" (Manual digital signal selection)
- "Analog"

- Set "D – Auto" or "D – Manual" when you have made connections to the DIGITAL VIDEO 1 COAX. IN jack or the DIGITAL VIDEO 2 OPT. IN jack.
- When "D – Auto" is set, the format of the digital audio signal being input is automatically selected and decoded.
- When "D – Manual" is set, the format of the digital audio signal being input is manually selected using the **LSTN M.** key on the remote control unit.
- For more details on selecting a digital audio format, see "Surround play" on page 54.
- Set "Analog" when you have made connections to the AUDIO – VIDEO 1 PLAY IN/REC OUT jacks or the AUDIO – VIDEO 2/6 CH INPUT discreet input jacks (stereo/6-channel).

Basic operation

Reproducing sound with enhanced bass (EX.BASS) (NV-301 only)

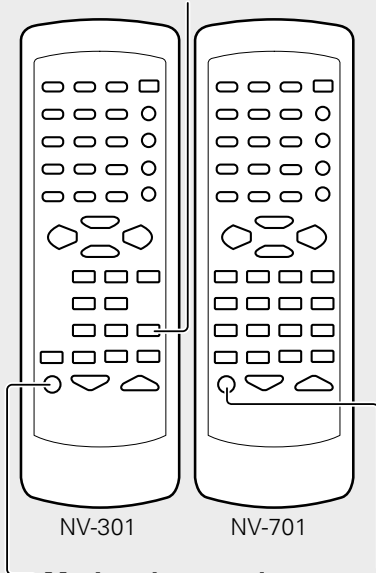

Muting the sound temporarily (MUTE)

Listening through headphones (optional)

Insert the headphone plug into the PHONES jack.

- The sound from all speakers is cut off.

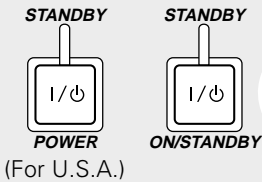
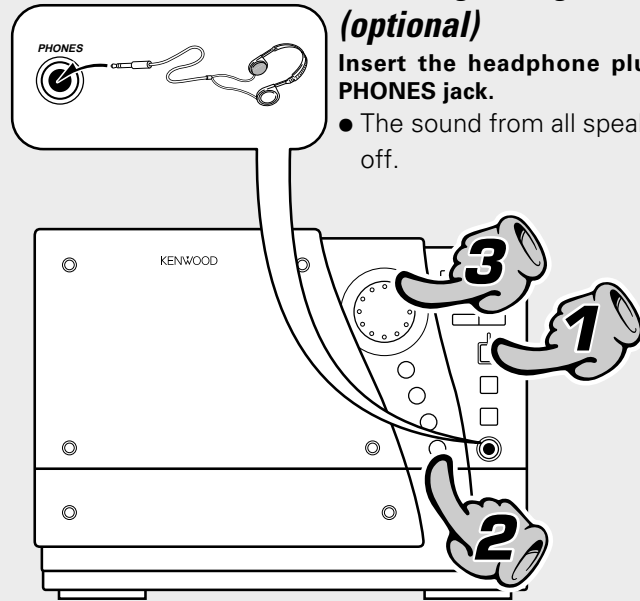

1. Switching the power ON (OFF)

When the power is ON, pressing the ON/STANDBY I/⏻ (POWER) key puts the unit in the standby mode and the STANDBY indicator lights up.

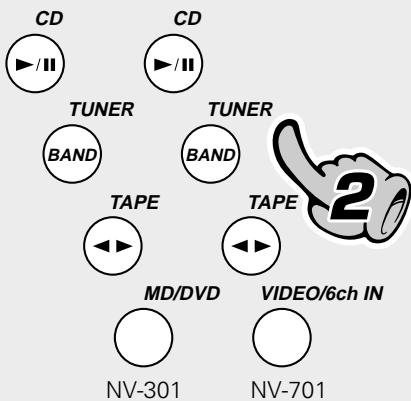

2. Selecting the desired output

Select the desired source by pressing the CD, TUNER, TAPE, MD/DVD (NV-301 only), or VIDEO/6ch IN (NV-701 only) key.

- When you press the TAPE or CD key, the unit starts playback automatically (if a tape or CD has been loaded beforehand).
- If you select the MD/DVD (NV-301 only), or VIDEO/6ch IN (NV-701 only) external input mode, also read the instruction manual of the component connected to the MD/DVD (NV-301 only) jacks or VIDEO jacks (NV-701 only).
- (NV-701 only) Pressing the VIDEO/6ch IN key repeatedly switches the input between the components connected to the VIDEO 1 and VIDEO 2 jacks.

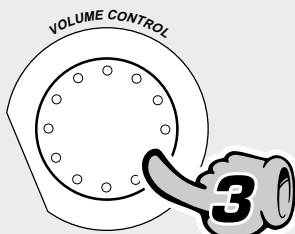

3. Volume adjustment

- The display shows a reference value.

Muting the sound temporarily (Remote control unit only)

Blinks

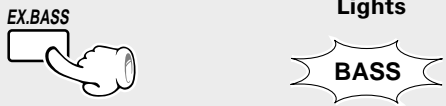

- Press again to resume the original volume.
- The sound muting is also canceled when the volume is controlled.

Reproducing sound with enhanced bass (Exbass) (Remote control unit only) (NV-301 only)

- Each press switches Exbass Mode on and off alternately.
- The Exbass Mode is switched off at factory settings.

Selecting 6-channel audio input (NV-701 only)

When you want to select 6-channel audio input after having made 6-channel connections, press and hold VIDEO/6ch IN to select "6ch Input" instead of the "Video2" input. To select another input source from VIDEO2 (digital or 2-channel analog), press and hold again until "Video2" appears in the display.

One-touch operation function

The power can also be turned ON by pressing the CD, TUNER, or TAPE key.

It is also possible to turn the power ON by simply pressing the OPEN/CLOSE (▲) key.

- When the CD or TAPE input is selected and a disc has been loaded in the disc tray or a tape has been loaded in the deck for use in playback, playback starts automatically.

Standby mode

While the STANDBY indicator of the unit is lit, a small amount of current is flowing into the unit to back up its internal memory. (The TIMER indicator also lights if a timer program has been activated before entering the STANDBY mode.)

This condition is referred to as the standby mode of the unit. While the unit is in the standby mode, it can be turned ON from the remote control unit.

This unit has been designed to minimize power consumption.

When CD has been selected.



CD Playback



If a disc has already been loaded in the CD player and the power is OFF, simply pressing the CD key automatically turns the power ON and sets the function selection to CD.

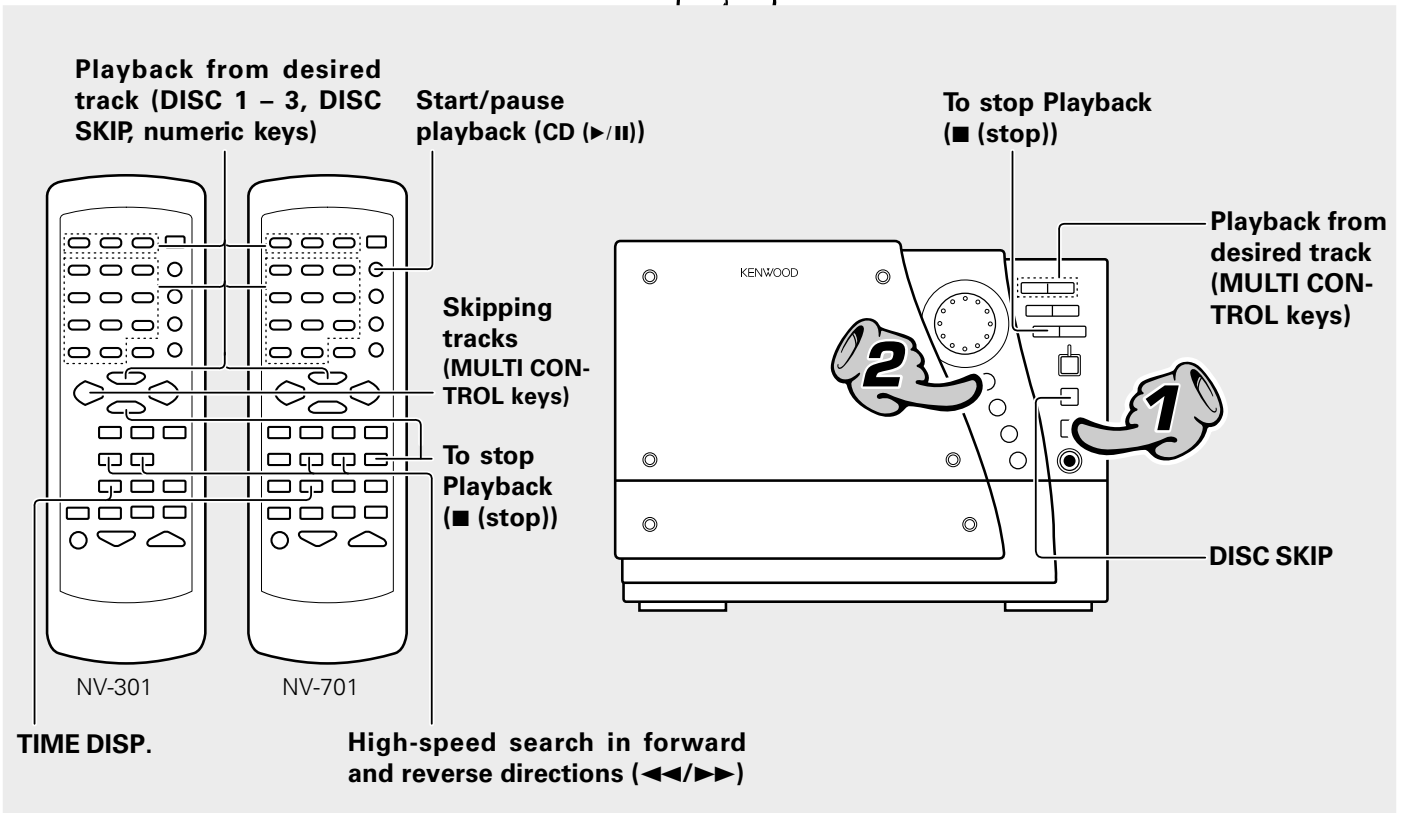

OPEN/CLOSE



The tray opens when the key is pressed and closes when the key is pressed again.

1. Load discs.

- ① Open the tray.
- ② Place discs.
- ③ Close the tray.

Disc played first when the CD (▶/||) key is pressed.

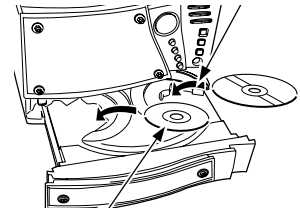

The label must be on top.

2. Start playback.



- After a few seconds, playback starts from the first track.
- Playback stops after having played all the discs in the trays. (Relay play)
- When the **OPEN/CLOSE (▲)** key is pressed during playback, the tray opens but playback continues. However, the **DISC SKIP** key is inoperative at this time.

Skipping tracks

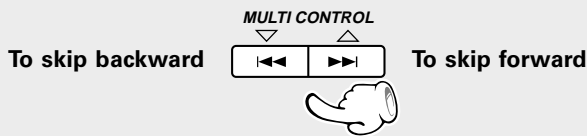

- The tracks in the direction corresponding to marks on the MULTI CONTROL keys (◀◀ and ▶▶) are skipped, and the selected track will be played from the beginning.
- When the MULTI CONTROL key (◀◀) is pressed once during playback, the track being played will be played from the beginning.
- The CD tracks can also be skipped using the MULTI CONTROL keys (◀◀ and ▶▶) on the remote control unit.

High-speed search in forward and reverse directions (Remote control unit only)

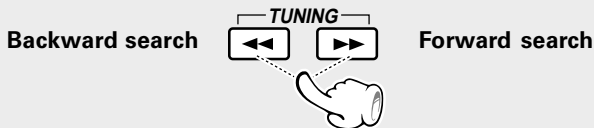

- Playback starts from the location where the key is released.

- Do not touch the playing side of disc.
- Rotate the tray with the **DISC SKIP** key to insert the third disc.
- The tray containing the disc to be played should come to the front right position when the unit is seen from the front.

The selected disc is indicated.

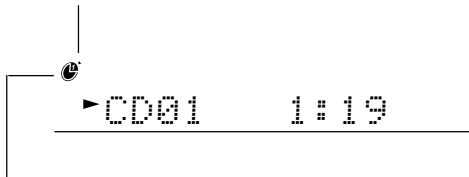

Lights when a disc is inserted at the time of playback.

Playback from a desired track

Select the disc

(Main unit)

(Remote control unit)

Select the desired track No.

Press the numeric keys as shown below....

To select track No. 23: **+10 +10 3**

To select track No. 40: **+10 +10 +10 +10 0**

To pause playback



- Each press pauses and plays the CD alternately.

To stop playback

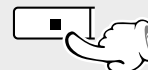

Time display on the CD player (Remote control unit only)

Each press of the **TIME DISP.** key switches the displayed time information.

- ① 1 : 12 Elapsed time of track being played
- ② - 4 : 18 Remaining time of track being played
- ③ 5 : 46 Elapsed time of disc being played
- ④ - 63 : 14 Remaining time of disc being played

- When the CD being played contains more than 30 tracks, the remaining time of tracks with numbers 31 and higher is displayed as "--:--".
- Only the elapsed and remaining time of the track being played is displayed during program playback and random playback.

Tape playback



When the power is off:
By loading a tape in the cassette deck beforehand, simply pressing the play key automatically turns the power ON and sets the function selection to Tape.

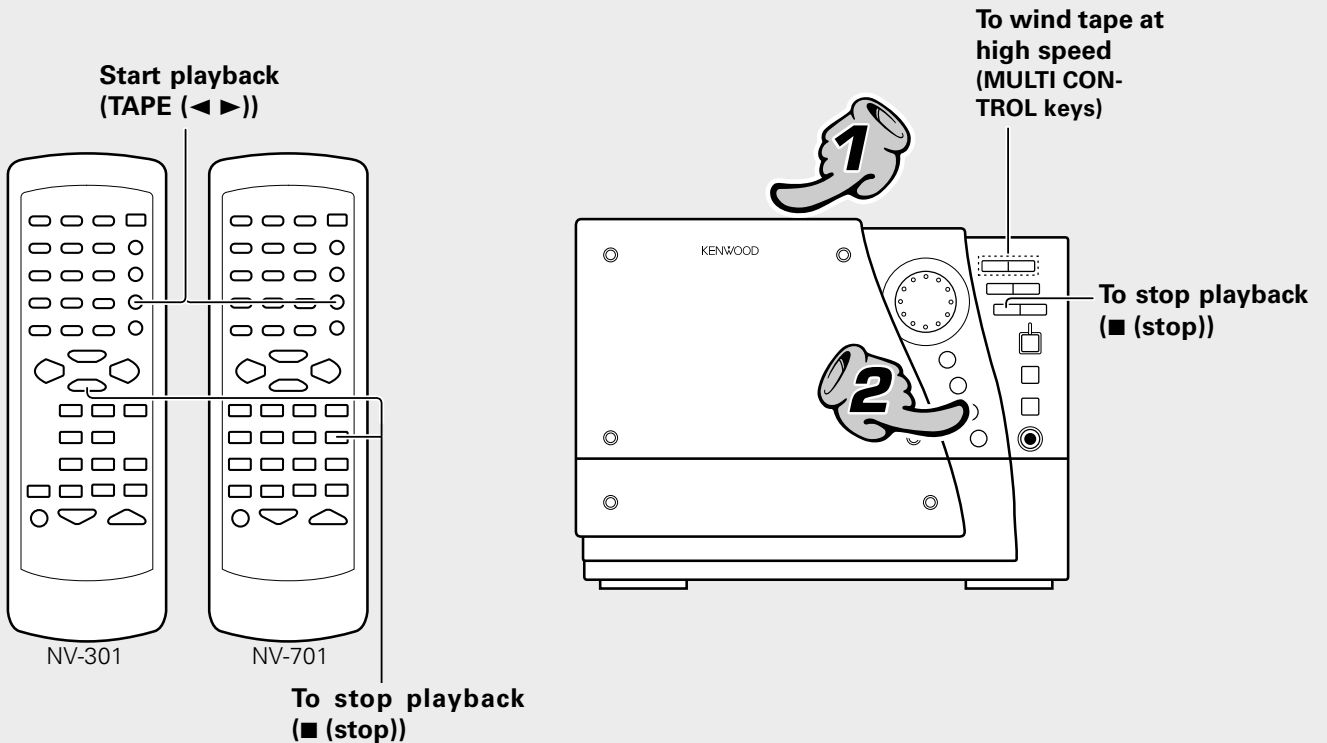

1. Load a cassette tape.

- ① Open the cassette holder.
- ② Insert a tape and close the door.
Be sure to load the top of the tape in the cassette holder first with the side you want to play facing up.

- Normal (TYPE I) or high (TYPE II) tape selection is set automatically.
- Remove tape slack before loading.
- Close the door securely.

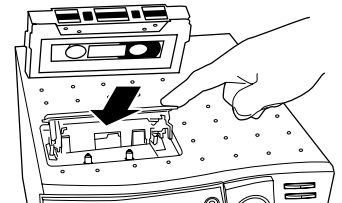

2. Select the TAPE input.

The deck starts playback.

- Each time you press the **TAPE (< >)** key, the playback direction changes.

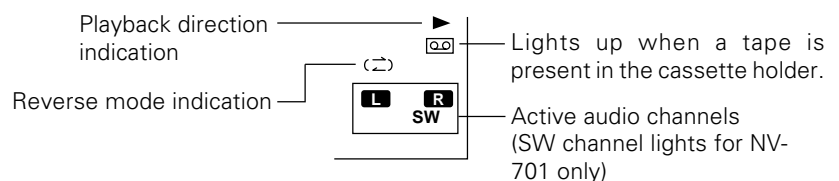

- If the tape transport direction is opposite to the desired direction, press the **TAPE (< >)** key to reverse the direction.

To wind tape at high speed

- Press the ■ (stop) key to stop fast winding.

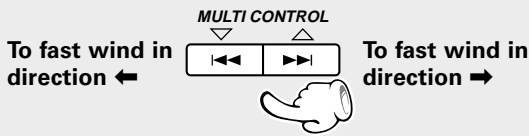

To skip to a song or selection on a tape (DPSS)

Press the MULTI CONTROL (◀◀ or ▶▶) during playback. Pressing the keys repeatedly adjusts the number of songs or selections to be skipped.

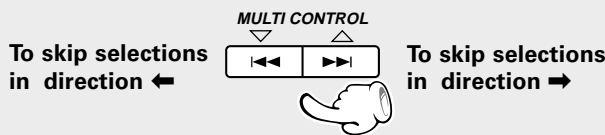

DPSS FF 02

When a tape is fast forwarded two songs

DPSS REW 01

When a tape is rewound to the beginning of the current selection

- There must be a gap of silence lasting at least 4 seconds long between selections.
- This function may not work properly with tapes that have gaps of silence lasting less than four seconds or selections containing numerous silent passages.
- The search stops at the end of the tape even if the number of selections to be skipped has not yet been reached.

To stop playback



- Do not take out the cassette tape until the tape transport has stopped completely.

To select the reverse mode

You can select the manner in which the cassette tape is played back or recorded on.

1 Select "Tape Options".

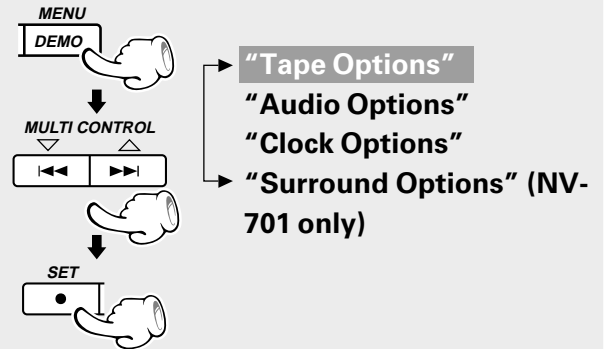

2 Select "Reverse Mode".

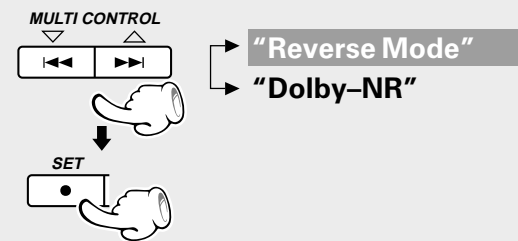

3 Select the reverse mode.

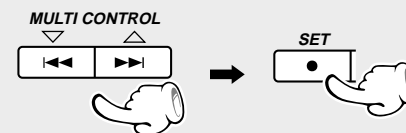

The following items can be selected by pressing the MULTI CONTROL keys repeatedly.

- "One Way" : Playback stops after having played one side of tape. "⏮" lights in the display.
- "Reverse" : Playback stops after having played both sides of tape in a deck. "⏮" lights in the display.
- "Endless" : Continuous playback of both sides of tape. "⏮" lights in the display.

4 Save the setting and exit the mode.



To reduce noise in playback

You can select Dolby NR (Noise Reduction) to reduce high frequency noise and improve the sound of audio playback when listening to tapes.

1 Select "Tape Options".



2 Select "Dolby-NR".

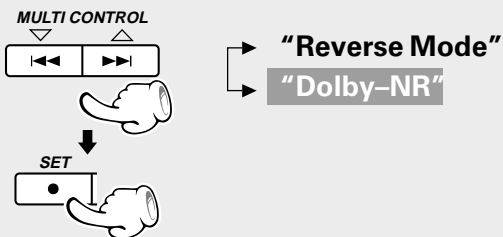

3 Turn Dolby NR on or off.

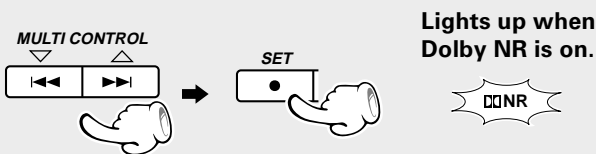

The following items can be selected by pressing the MULTI CONTROL keys repeatedly.

- "Dolby NR-ON": Add noise reduction to the audio playback.
- "Dolby NR-OFF": Play the cassette tape without any noise reduction processing.

4 Save the setting and exit the mode.



Transport direction indicators

The indicators (◀, ▶) indicate the current direction in which the tape advances when playback or recording is started automatically by the one-touch operation function, etc. This direction is the direction stored in memory when tape playback was last stopped. (To switch the tape transport direction, press the TAPE (◀▶) key to reverse the direction, then press the ■ (stop) key.)

Tape direction indicators

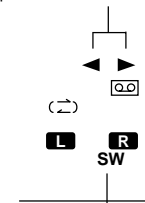

(SW channel lights for NV-701 only)

A tip for the use of the tape counter

The tape counter is set to "0000" when a cassette tape is loaded. In case you want to interrupt recording (playback) in the middle of the tape, the counter reading will be helpful as a reference for locating the same location when continuing the recording (playback) the next time. The tape counter figure decrements during recording or playback of the reverse side (while the ▶ tape transport indicator is lit). To reset the tape counter to "0000", open the cassette holder once. The counter will be reset.

N-TAPE 0000

"N-TAPE" or "C-TAPE" appear to indicate whether the tape in the cassette deck is normal or high bias.

Receiving broadcast stations

It is also possible to receive stations by one-touch operations.



When the TUNER key is pressed, this unit will be switched on automatically and tuned to the last received frequency.

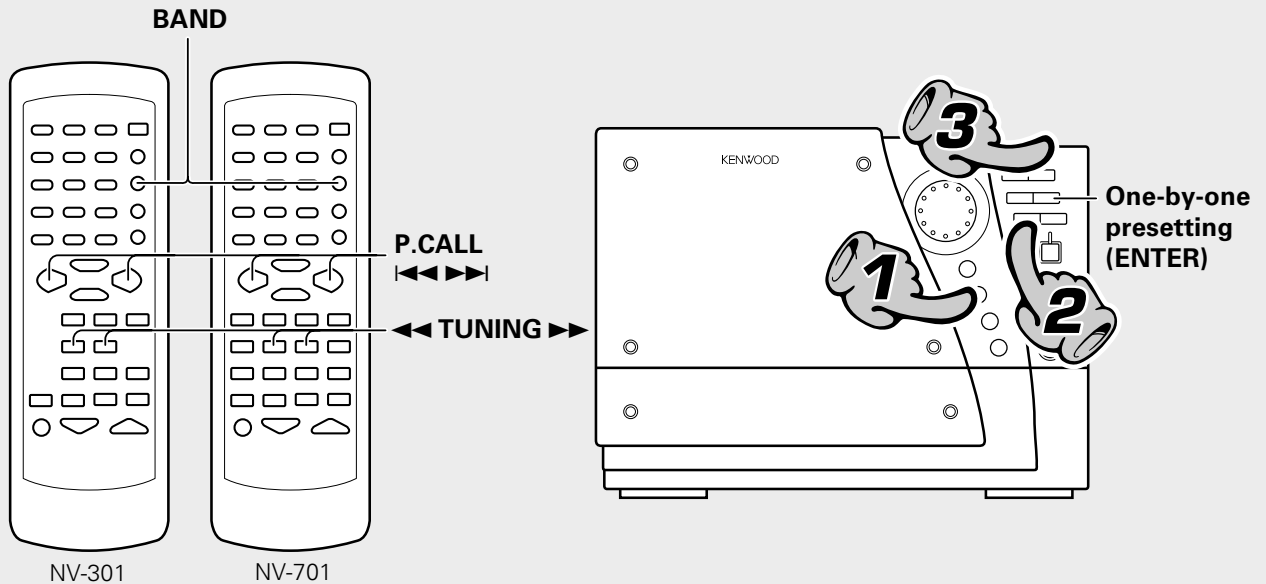

1. Select the broadcast band.

Each press changes the band.

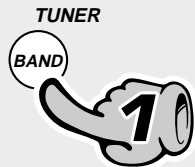

- ① FM or ① FM
- ② AM or ② MW (AM)
- ③ LW

•The broadcast bands defer depending on the model (country or area).

Example when an FM station is received



2. Select the tuning mode.

The following tuning modes can be selected by pressing the MULTI CONTROL keys repeatedly.

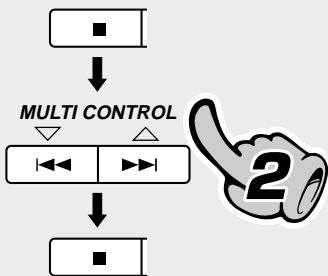

- “Auto/Stereo” (Auto tuning)
- “P. call on” (Preset call)
- “Manual/Mono” (Manual tuning)

- Normally, use the “Auto/Stereo” (Auto tuning) mode.
- Use the “Manual/Mono” when reception is noisy due to weak reception. (In the manual mode, stereo broadcasts are received in monaural.)
- When the **P.CALL** keys on the remote control unit are pressed, “P. call on” is displayed and the preset call mode is automatically selected.

Continued on next page...

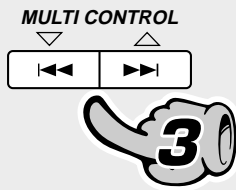

3. Select a station.

- Auto tuning** : Press the **MULTI CONTROL** keys to receive the next tuned station automatically.
(On the remote control unit, press the ◀◀ or ▶▶ key.)
- P. call on** : Press the **MULTI CONTROL** keys to select a stored preset. When a key is held depressed, preset stations will be skipped at an interval of about 0.5 second. See the procedures below for details on presetting stations.
(On the remote control unit, press the number buttons.)
- Manual tuning** : Press the **MULTI CONTROL** keys to select a frequency.
(On the remote control unit, press the ◀◀ or ▶▶ key.)

Collective presetting of stations (Auto memory)

Keep the **TUNER (BAND)** key depressed for about 2 seconds. (Main unit only)

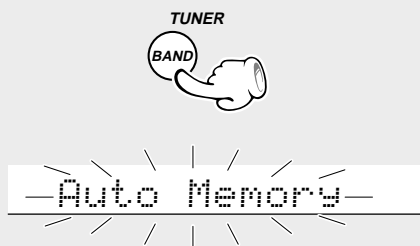

- When the Auto memory is complete, the station assigned to preset 1 is tuned.

01 87.50MHz

- With models that have RDS functions (U.K. and Europe models only), only FM stations are preset using the Auto Memory function. To preset AM (MW/LW) stations, please follow the procedure in "One-by-one presetting (manual preset)" on this page.
- Some stations may not be able to be preset if their reception conditions are weak.
- A maximum of 40 stations are preset automatically with priority given to the FM band.
- When there are many stations and the intended station has not been preset, please follow the procedure in "One-by-one presetting (manual preset)" on this page.
- The stations which were previously preset are overwritten.

One-by-one presetting (manual preset)

- 1 Keep the **ENTER** key depressed for about 2 seconds during reception to enter the memory mode.



(Presetting is cancelled when no operation is executed for 5 seconds or more.)

- 2 Select one of the preset numbers from 1 to 40.

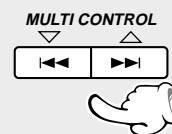

(Presetting is cancelled when no operation is executed for 5 seconds or more.)

- 3 Press the **ENTER** key to set the preset.



- Repeat the above procedure to preset other stations.
- If two stations are preset under the same number, the previous memory is replaced with the newest preset information.

CHANNEL SPACE setting *(Except for the U.S.A., Canada, U.K., Europe, and Australia)*

The space between radio channels has been set to the one that prevails in the area to which the system is shipped. However, if the current channel space setting does not match the setting in the area where the system is to be used, for instance when you move from area 1 or area 2 shown in the following table or vice versa, proper reception of AM/FM broadcasts cannot be expected. In this case, change the channel space setting in accordance with your area by referring to the following table.

Area	CHANNEL SPACE freq.
① U.S.A., Canada and South American countries	FM : 100 kHz AM : 10 kHz
② Other countries	FM : 50 kHz AM : 9 kHz

① Press the ON/STANDBY (or POWER) (I / ⏻) key to put the unit in the standby mode.

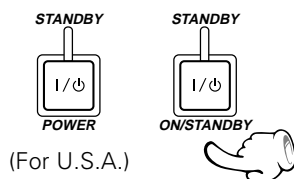

② Press the ■ (stop) key to select the channel spacing setting.

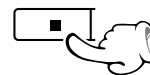

③ Press the ■ (stop) key repeatedly to set the channel space.

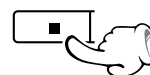

- ① "FM100/AM10" STEP
- ② "FM 50 /AM 9" STEP

- The display turns off 10 seconds after the setting is made if no further changes are made.
- The "AM" display is variable depending on the model (country or area), and "MW" may be displayed in some areas.
- When the channel spacing is changed, all stored tuner presets are cleared.

Recording onto a tape



Note that this cassette deck cannot record onto Metal tapes.

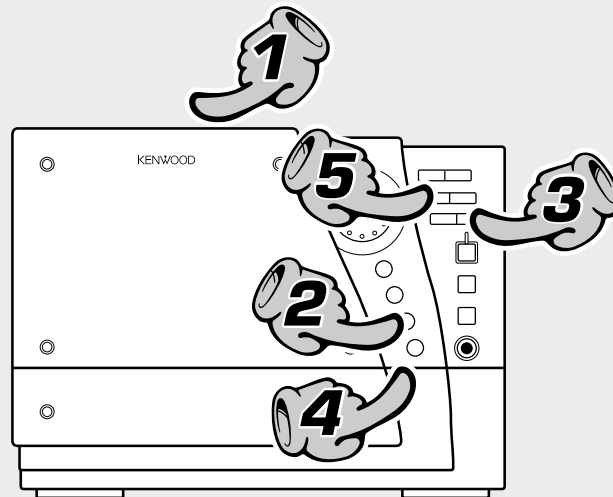

1. Load a cassette tape.

- ① Open the cassette holder.
- ② Insert a tape top end first with the side you want to record on the top.
- ③ Close the holder.
 - Differentiation between normal (TYPE I) and high (TYPE II) tape is set automatically.
 - Remove tape slack before loading.

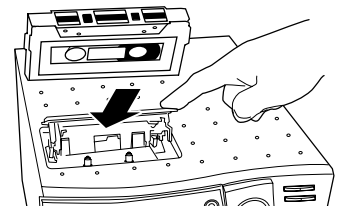

2. Select the tape transport direction.

To reverse the transport direction



- ① Select the TAPE input by pressing the TAPE key.
- ② Press the TAPE key so that the desired direction indicator appears. → 28
- ③ Stop playback by pressing the ■ (stop) key.

- When recording is started, the tape is transported in the direction selected in this step.
- Wind the tape to the position where recording is to be started.

3. Set the recording condition.

Select the reverse mode.



→ 29

Select CD, TUNER, or MD/DVD (NV-301 only) or VIDEO/6ch IN (NV-701 only) input for the source.

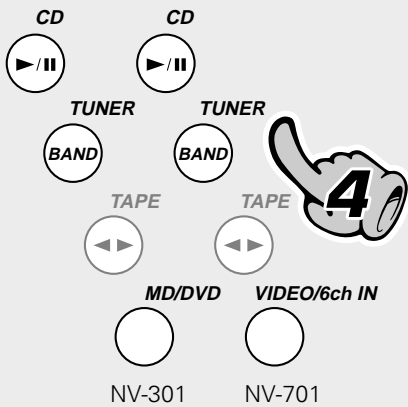

4. Select the source to be recorded. (Except for TAPE input)

Press the desired key.



The input source component to be recorded should be displayed.

- If a disc has already been loaded when the CD input is selected, it starts to play automatically. In this case, press the ■ (stop) key to stop it.
- When you select VIDEO/6ch IN (NV-701 only) or MD/DVD (NV-301 only) to record the external input, adjust the input level. → 51

5. Start recording.

① Start recording.

② Play (or tune) the input source to be recorded.

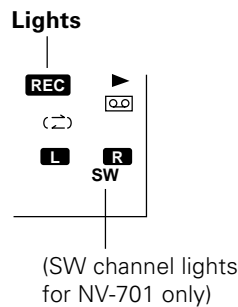
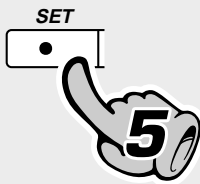

- If a disc has already been loaded when the CD input is selected, it will start recording automatically.
- Recording stops automatically when the tape side(s) to be recorded have been fully recorded.
- Press the stop (■) key of the cassette deck unit to stop recording (see the next page).

To pause recording (Main unit only)

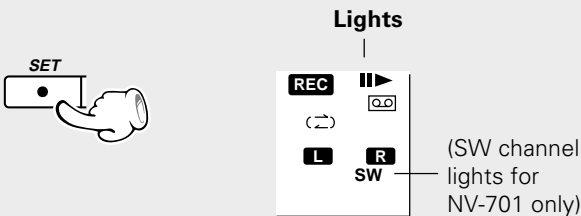

- Pressing the **SET** (●) key pauses recording after leaving a non-recorded space of about 4 seconds.
- If the key is pressed again in less than 4 seconds after it has been pressed, recording resumes from that instant.

Tips in CD recording

When recording CD tracks onto a tape, if you leave the cassette deck in record-pause mode beforehand, the cassette deck recording can be started at the same time as the CD starts to be played (synchronous recording function).

- ❶ Set the CD player in pause mode.
- ❷ Select the track to be recorded with the MULTI CONTROL (◀◀, ▶▶) keys.
(The CD player pauses at the beginning of the selected track.)
- ❸ Put the cassette deck in record-pause mode.
(Press the SET (●) key twice in succession.)
- ❹ Start playing the CD.
(Synchronous recording starts.)

- Recording stops when the ■ (stop) key is pressed.

Beat cancel function

In some cases, noise may be produced while recording AM (MW/LW) stations. When this occurs, press the TUNER (BAND) key while the unit is in the record pause mode to reduce or eliminate the noise for a better recording.

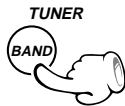

- Each press switches the beat cancel function on and off alternately.

Listening in the desired sequence (program playback)

Any titles on the discs in the tray can be listened to in the desired sequence. (Max. 32 steps)

Select the "CD" input.

1 Check that the CD player is in the stop mode.

If it is in play mode



2 Select "CD Program Play".

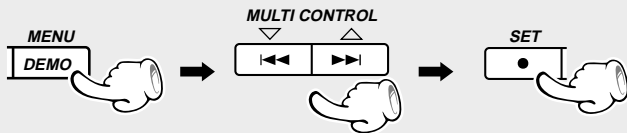

3 Enter track numbers in the order you want to play them.

1 Select the disc.

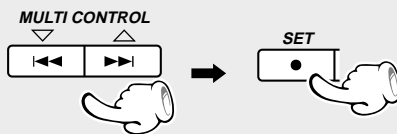

2 Select the track.

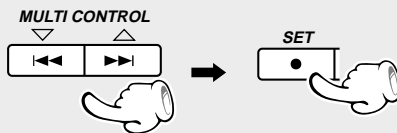

(To select other tracks, repeat steps 1 and 2 for each of the additional tracks.)

3 Press the ENTER key.



The following items can be selected by pressing the MULTI CONTROL keys repeatedly.

- "CD Program Play"
- ("Recording Options")
- "Tape Options"
- "Audio Options"
- "Clock Options"
- "Surround Setup" (NV-701 only)

← "CD Program Play" is scrolled in the display

CD Program P

← "Select Disc/Track No." is scrolled in the display

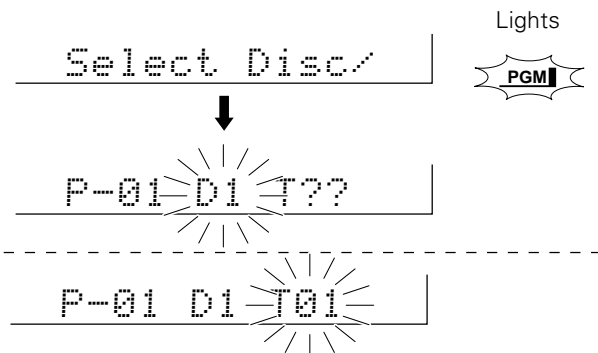

- Even if you program a disc or track which does not exist in the tray, it is deleted automatically in playback.
- Press the **BACK** key to return to the previous step and restart operation from there.
- Up to 32 tracks can be programmed. When "Full" is displayed, no more tracks can be programmed.

← "Press "ENTER" to Start, "MULTI" to Edit and Check" is scrolled in the display

Press "ENTER"

Continued on next page...

4 Start programmed playback.

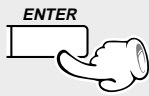

(Playback starts from the first programmed track (program step number 1))

- Press the **MULTI CONTROL** keys during program playback to go to the previous or next programmed track.
- When the left **MULTI CONTROL** key is pressed once during playback, the track being played will be played from the beginning.

Press the **TIME DISP.** key on the remote control unit to switch the time display.

Check the programmed tracks (and replace, add, or delete tracks as required).

After a program has been made

1 Select "CD Program Play" for program editing.

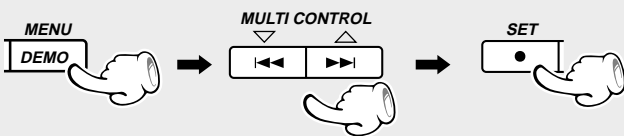

To check:

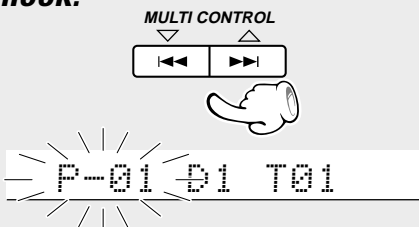

- The programmed tracks are displayed in sequence.

To replace a track in the program:

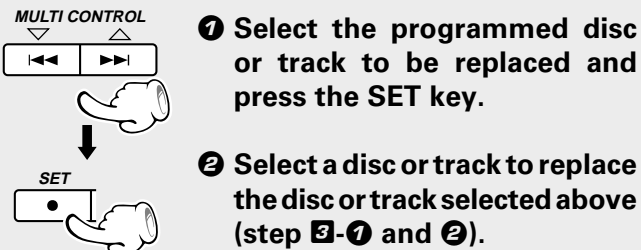

- 1 Select the programmed disc or track to be replaced and press the **SET** key.
- 2 Select a disc or track to replace the disc or track selected above (step 1-1 and 2).

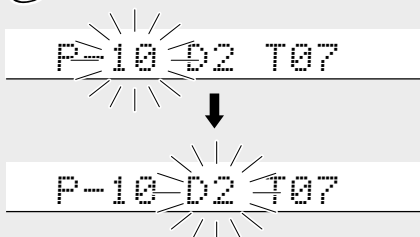

- The blinking item can be replaced.

To add a track to the program:

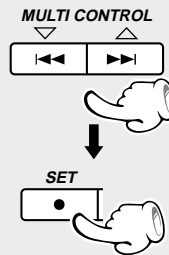

- 1 Select the display as shown on the left, and press the **SET** key.
- 2 Perform the same operation as in step 1-1 and 2 on the previous page.

Display when 12 tracks have been programmed



- The added track number is added to the end of the existing program.

To delete a track from the program:

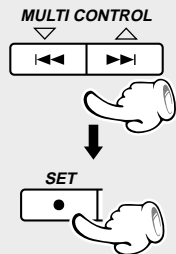

- 1 Select the programmed disc of the step to be cleared and press the **SET** key.
- 2 Select "Clear" and press the **SET** key.

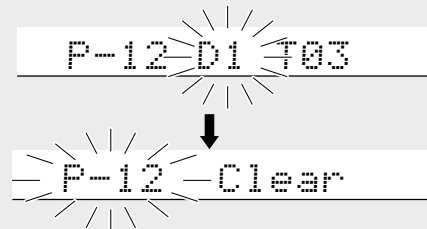

2 Finish editing and start playback.



To quit the program mode

- 1 Select "CD Program Play".



- 2 Press the **MENU** key.

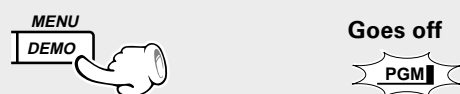

- If the **MENU** key is pressed during playback, normal playback in the order of tracks resumes from the current track.
- The program mode can also be canceled by pressing the **OPEN/CLOSE** (\blacktriangle) key.

Repeated playback

Desired titles or discs can be played back repeatedly.

Please note that repeat playback of a single track, single disc, or all discs is not possible during programmed playback. If the PGM indicator is lit in the display, perform the procedure on page 38 to cancel the program playback mode.

Select the "CD" input.

To repeat only one track

1 Select the disc.

(Main unit)



(Remote control unit)



2 Select the track.

(Main unit)

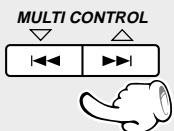

(Remote control unit)

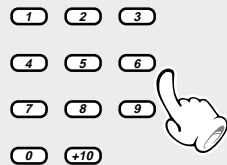

3 Select "One Track Repeat".

(Remote control unit only)

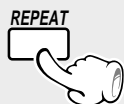

Press the key repeatedly to switch the display.

- ① "One Track Repeat"
- ② "One Disc Repeat"
- ③ "All Discs Repeat"
- ④ "Repeat off" (Repeat canceled)

←"One Track Repeat" is scrolled in the display

Lights



One Track Re

To repeat a disc

1 Select the disc.

(Main unit)



(Remote control unit)



2 Select "One Disc Repeat".

(Remote control unit only)



Press the key repeatedly to switch the display.

- ① "One Track Repeat"
- ② "One Disc Repeat"
- ③ "All Discs Repeat"
- ④ "Repeat off" (Repeat canceled)

←"One Disc Repeat" is scrolled in the display

Lights

One Disc Rep



To stop repeated playback

Press the REPEAT key repeatedly until the repeat mode is switched off.

- The repeat mode can also be canceled by pressing the ■ (stop) key.

Select the "CD" input.

To repeat all discs

1 Select the disc to be played first.

(Main unit)



(Remote control unit)



2 Select "All Discs Repeat".

(Remote control unit only)



Press the key repeatedly to switch the display.

- ① "One Track Repeat"
- ② "Disc Repeat"
- ③ "All Discs Repeat"
- ④ "Repeat off" (Repeat canceled)

← "All Discs Repeat" is scrolled in the display

ALL Discs Re

Lights



To repeat programmed tracks

1 Perform steps 1 through 3 of the procedure in "Listening in the desired sequence (program playback)" to program the desired CD tracks.

Lights



→ 37

- All of the programmed tracks will be played repeatedly.

2 Start playback.



3 Select "PGM All Discs Repeat".

(Remote control unit only)



Press the key repeatedly to switch the display.

- ① "PGM One Track Repeat"
- ② "PGM All Discs Repeat"
- ③ "Repeat off" (Repeat canceled)

← "PGM All Discs Repeat" is scrolled in the display

PGM ALL Disc

Lights



To stop repeated playback

Press the REPEAT key repeatedly until the repeat mode is switched off.

- The repeat mode can also be canceled by pressing the ■ (stop) key.

Random playback

As the titles are selected randomly each time, the music can be enjoyed of it. Random playback can play tracks in one to three discs.

Please note that random playback is not possible during programmed playback. If the PGM indicator is lit in the display, perform the procedure on page 38 to cancel the program playback mode.

Select the "CD" input.

1 Select the RANDOM mode.

(For "One Disc Random" playback, select the disc in advance.)

(Remote control unit only)



To select another track in the middle of playing one





- Pressing the left arrow key once returns to the beginning of the track being played.

To repeat random playback

Select "One Disc Random Repeat".

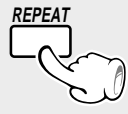
(Remote control unit only)

Each press switches the modes as follows.

- "One Disc Random Repeat" (Random repeat mode)
- "One Disc Random" (Repeat canceled)

Press the key repeatedly to switch the display.

- "One Disc Random" Random play of one disc
- "All Discs Random" Random play of all discs
- "Random off" (Normal playback)

Random play of one disc

← "One Disc Random" is scrolled in the display

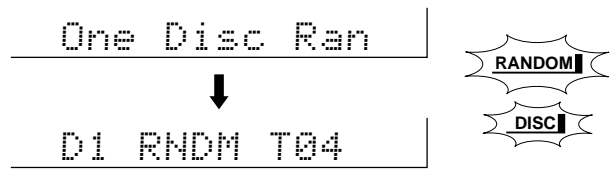

Random play of all discs

← "All Discs Random" is scrolled in the display

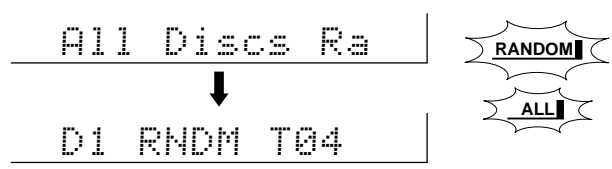

- Playback stops after each title has been played once.

To cancel random playback

Select "Random off".

(Remote control unit only)



Goes out



- The displayed character information returns to the normal display and normal playback in the order of the track numbers starts from the track being played.

RDS is a system which transmits useful information (digital data) for FM broadcasts together with the broadcast signal. Tuners and receivers designed for RDS reception can extract the information from the broadcast signal for use with various functions such as automatic display of the station name.

Set the reception band to FM. Preset RDS stations with the auto memory function.



This unit is equipped with the following functions utilizing RDS data:

PTY (Program TYPe) Search :



The tuner automatically searches for a station which is currently broadcasting a specified program type (genre).

The "RDS" indicator lights up when an RDS broadcast (signal) is received.

PS (Program Service) Display : (See below.)

When an RDS broadcast is received, the station name is automatically displayed.



- Some functions may not be provided or be given different names depending on countries or areas.

Note before the use of RDS

For reception of RDS stations, the auto presetting function must be used to preset the stations. With the auto memory function, RDS stations are preset with priority.

To switch the display contents

Pressing the RDS DISP. key changes the display contents.

(Remote control unit only)

NV-301



NV-701



Display mode priority

When an RDS broadcast is received :

① **PS (Program Service) Display :**

When an RDS broadcast is received, the station name is automatically displayed. If it is not an RDS broadcast, "No PS" is displayed.



② **Frequency Display :**

The frequency of the current station is displayed.



Searching for a desired program type (PTY search) (For U.K. and Europe)

By specifying the type of program (genre) you want to listen to, the tuner automatically searches for a station which is currently broadcasting a program of the specified type.

Set the reception band to FM. Preset RDS stations with the auto memory function.



1 Select the PTY search mode.

(Remote control unit only)



2 Select the desired program type.

Use program type table on the right for your convenience.

To select using the **◀▶** keys

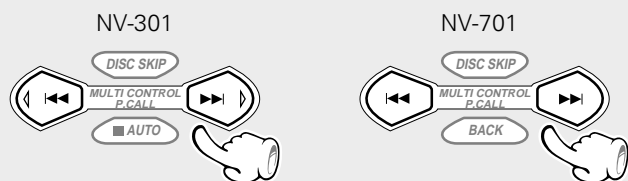

Select while "PTY" is lit.

The **◀▶** keys can be used to select one of the 29 program types by displaying them in sequence. Press and hold the key and release it when the desired program type appears.

PTY: ROCK M

When an RDS broadcast is received, the program type is shown on the display. If the station is not an RDS station, "None" is displayed.

Program type table

◀▶ keys	Program Type Name	Display
DOWN ↑ UP ▶▶	Pop Music	POP M
	Rock Music	ROCK M
	Easy Listening Music	EASY M
	Light classical	LIGHT M
	Serious classical	CLASSICS
	Other Music	OTHER M
	News	NEWS
	Current Affairs	AFFAIRS
	Information	INFO
	Sport	SPORT
	Education	EDUCATE
	Drama	DRAMA
	Culture	CULTURE
	Science	SCIENCE
	Varied	VARIED
	Weather	WEATHER
	Finance	FINANCE
	Children's program	CHILDREN
	Social Affairs	SOCIAL
	Religion	RELIGION
	Phone In	PHONE IN
	Travel	TRAVEL
	Leisure	LEISURE
	Jazz Music	JAZZ
	Country Music	COUNTRY
	National Music	NATION M
	Oldies Music	OLDIES
	Folk Music	FOLK M
	Documentary	DOCUMENT
Alarm Test*	TEST	
Alarm*	ALARM	

* This item appears only when the unit receives the data. You cannot select it using the **◀▶** keys.

Continued on next page...

3 Start the search.

(Remote control unit only)



(Press the key again during search to cancel it.)

- No sound is heard while "PTY" is blinking.
- If a program of the desired type cannot be found, "No Program" is displayed (blinking), then after several seconds the display returns to the original display.
- If a program of the desired type is found, that program is received and the program type name display changes temporarily to the frequency display, and then to the station name display.

To change to a different program type :

Repeat steps 1, 2, and 3.

When searching for a Rock Music broadcast

Display while the tuner is searching.

Program type name display.

Blinks

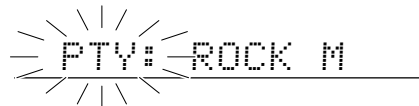

When a station is received.



Station name display.



When a station of the selected PTY cannot be found.

Blinks



Selection of a recording type

With this unit, the following edit recording is possible to suit different situations.



- Note that this cassette deck cannot record onto Metal tapes.
- When an edit recording type is selected, random and repeat playback is automatically canceled.

If you want to select the track to be recorded while playing a CD

Recording only the desired track → 46

CD ONE TRACK RECORDING

Perform this operation during CD playback when the track you want to record starts. This starts recording of the track from the beginning. This operation can only be performed when the CD player is in the play mode

If you want to record a CD with the track order as it is

Recording an entire CD → 47

CD DIRECT RECORDING

Perform "CD DIRECT RECORDING" operation while the CD player is in the stop mode to start recording.

If you want to record only the tracks you want

Recording programmed tracks → 48

CD PROGRAM RECORDING

Program the desired tracks from up to 3 CDs in the order you want and record the programmed playback onto tape. This operation can only be performed when the CD player is in the stop mode

If you want to record the sound of multichannel digital sound tracks on tape (stereo downmix)

Recording a digital source → 49

DIGITAL SOURCE RECORDING

Perform "DIGITAL REC MODE" operation while the CD player is in the stop mode to start recording.



At the end of a tape, the music is not recorded on the leader tape portion. If you do not want the recording to be interrupted in the middle, refer to "Recording onto a tape" and start recording on side B. → 34

Regarding CD-TEXT (Remote control unit only)

When a CD-TEXT disc is played on this unit, it displays the text information (disc or track title) recorded on the CD.

To switch the displayed text information between the disc title and track title during playback, press the TEXT DISP. key.

(When pressed during playback)

NV-301

NV-701

TEXT DISP.
RDS DISP.



RDS DISP.
TEXT DISP.



Scrolls the track title display.

New Orleans

CD player's time display.

▶ CD01 0:02

Scrolls the disc title display.

World Music

Recording only the desired track (CD ONE TRACK RECORDING)

During CD playback, any track can be selected immediately for recording.



When effects are applied to the sound, the effect applied to the sound can be recorded. → 54

Recording preparations are required. → 34 (Steps 1 to 3)

1 Play a CD.



2 Select "Recording Options".



3 Select "CD One Track Recording".

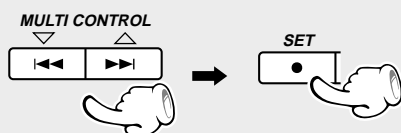

4 Start recording.



When recording has been completed, a non-recorded portion of 4 seconds will be produced and the cassette deck part will stop. The CD playback will be paused.

To record a different track, repeat steps 1 through 4.

- Select a mode other than random play.

The following items can be selected by pressing the MULTI CONTROL keys repeatedly.

"Recording Options"

"Tape Options"

"Audio Options"

"Clock Options"

"Surround Setup" (NV-701 only)

← "Recording Options" is scrolled in the display

Recording Op

The following items can be selected by pressing the MULTI CONTROL keys repeatedly.

"CD One Track Recording"

(Only during CD playback)

"Timer Recording"

"Digital Rec Mode" (NV-701 only)

← "CD One Track Recording" is scrolled in the display

▶ CD One Track

← "Press "ENTER" to start" is scrolled in the display

Press "ENTER

- Playback restarts from the beginning of the track being played and recording starts at the same time.

To end recording in the middle



- Both the cassette deck and CD player stop.

Recording an entire CD (CD DIRECT RECORDING)

Perform the following operation while the CD player is in play or stop mode to start recording at the same time as the start of playback.



When effects are applied to the sound, the effect applied to the sound can be recorded. → 54

Recording preparations are required. → 34 (Steps 1 to 4)

1 Select "Recording Options".

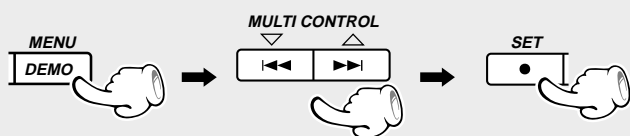

The following items can be selected by pressing the MULTI CONTROL keys repeatedly.

- "CD Program Play"
- "Recording Options"
- "Tape Options"
- "Audio Options"
- "Clock Options"
- "Surround Setup" (NV-701 only)

← "Recording Options" is scrolled in the display

Recording Op

2 Select "CD Direct Recording".

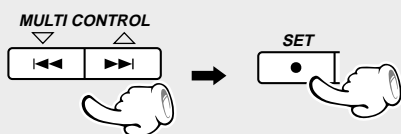

The following items can be selected by pressing the MULTI CONTROL keys repeatedly.

- "CD Direct Recording"
- "CD Program Recording"
- "Timer Recording"
- "Digital Rec Mode" (NV-701 only)

← "CD Direct Recording" is scrolled in the display

CD Direct Re

3 Select the disc.

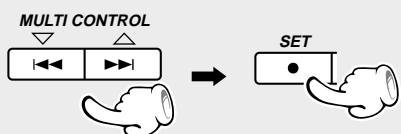

← "Select Disc No." is scrolled in the display

Select Disc

↓

Disc No. 1

← "Press "ENTER" to start" is scrolled in the display

Press "ENTER

4 Start recording.



- Recording of CD starts at the same time as playback.
- At the end of tape, the music is not recorded on the leader tape portion. If you do not want the recording to be interrupted in the middle, refer to "Recording onto a tape" and start recording on side B. → 34

To end recording in the middle



- Both the cassette deck and CD player stop.

Recording programmed tracks (CD PROGRAM RECORDING)

Program the desired tracks from up to 3 CDs in the order you want and record the programmed playback onto tape.



When effects are applied to the sound, the effect applied to the sound can be recorded. → 54

Recording preparations are required. → 34 (Steps 1 to 4)

1 Select "Recording Options".

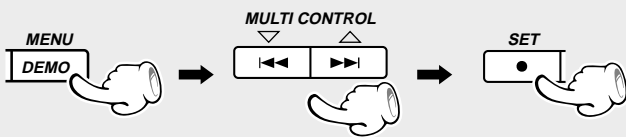

The following items can be selected by pressing the MULTI CONTROL keys repeatedly.

- "CD Program Play"
- "Recording Options"
- "Tape Options"
- "Audio Options"
- "Clock Options"
- "Surround Setup" (NV-701 only)

← "Recording Options" is scrolled in the display

Recording Op

2 Select "CD Program Recording".

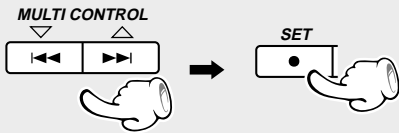

The following items can be selected by pressing the MULTI CONTROL keys repeatedly.

- "CD Direct Recording"
- "CD Program Recording"
- "Timer Recording"
- "Digital Rec Mode" (NV-701 only)

Lights



← "CD Program Recording" is scrolled in the display

CD Program R

3 Program the desired tracks.

- 1 Select tracks in the order you want to play them. (Perform step 3 on page 37.)
- 2 Check, replace, add or delete the programmed tracks as required. (Perform steps 1 and 2 on page 38.)

4 Start recording.

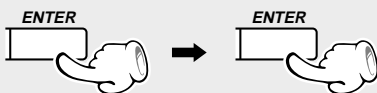

← "Press "ENTER" to Start, "MULTI" to Edit and Check" is scrolled in the display

Press "ENTER

To end recording in the middle



- Both the cassette deck and CD player stop.

- The program mode is maintained even after recording is completed. To return to the normal playback mode, cancel the program playback mode. → 38

Recording digital sound tracks (DIGITAL SOURCE RECORDING) (NV-701 only)

When a multichannel digital source is input from an externally connected component such as a DVD, the sound track can be recorded as a stereo mix.



When effects are applied to the sound, the effect applied to the sound can be recorded. → 54

Recording preparations are required. → 34 (Steps 1 to 4)

- 1 Select the input.**
- 2 Select "Recording Options".**
- 3 Select "Digital Rec Mode".**
- 4 Select the recording mode.**
- 5 Save the setting.**

(NV-701 only) Pressing the VIDEO/6ch IN key repeatedly switches the input between the components connected to the VIDEO 1 and VIDEO 2 jacks.

The following items can be selected by pressing the MULTI CONTROL keys repeatedly.

- "CD Program Play"
- "Recording Options"
- "Tape Options"
- "Audio Options"
- "Clock Options"
- "Surround Setup" (NV-701 only)

← "Recording Options" is scrolled in the display



The following items can be selected by pressing the MULTI CONTROL keys repeatedly.

- "CD Direct Recording" Lights
- "CD Program Recording" PGM
- "Timer Recording"
- "Digital Rec Mode" (NV-701 only)

← "Digital Rec Mode" is scrolled in the display

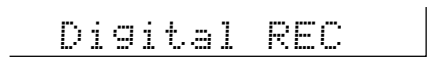

The following items can be selected by pressing the MULTI CONTROL keys repeatedly.

- "A-Rec Mode"
- "M-Rec Mode"

← "Press "ENTER" to save" is scrolled in the display.



To end recording in the middle

- The cassette deck stops.

- When "A-Rec Mode" automatic recording is selected, the tape player starts recording when an audio signal is detected.
- When "M-Rec Mode" manual recording is selected, the tape player starts recording when the ● (record) key is pressed.

Application section

Balance adjustment

Adjusts the balance of left and right volume.

Check that the CD player is in the stop mode.

1 Select "Audio Options".

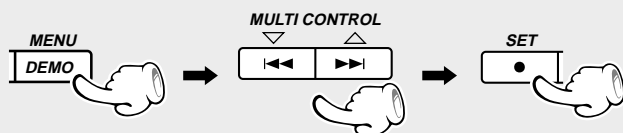

2 Select "Balance".

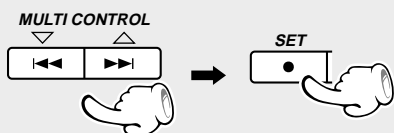

3 Adjust.

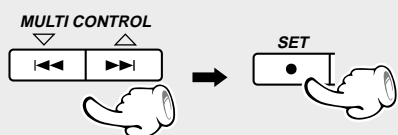

Shifts the balance to the left

Shifts the balance to the right

4 Save the setting.



The following items can be selected by pressing the MULTI CONTROL keys repeatedly.

- ("CD Program Play")
- ("Recording Options")
- "Tape Options"
- **"Audio Options"**
- "Clock Options"
- "Surround Setup" (NV-701 only)

← "Audio Options" is scrolled in the display

Audio Option

The following items can be selected by pressing the MULTI CONTROL keys repeatedly.

- "Exbass Mode" (NV-301 only)
- "Listen Mode" (NV-701 only)
- **"Balance"**
- "Tone Control"
- "Input level"
- "SW level" (NV-701 only)

← "Balance" is scrolled in the display

Balance

← "Adjust L/R balance" is scrolled in the display

Adjust L/R b

Indicates the center

L-----T-----R

Indicates the balance setting

← "Press "ENTER" to save" is scrolled in the display

Press "ENTER

Input level adjustment

The input level from an external component connected to the MD/DVD (NV-301) or VIDEO 1/VIDEO 2 (NV-701) jacks, such as an MD/CD recorder, DVD player, VCR, or analog turntable can be adjusted as desired. Adjust so that the volume of the input source sounds at an equivalent level to the CD.

1 Select the external input.

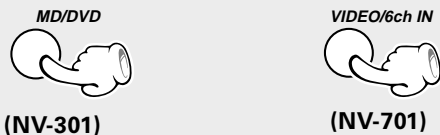

2 Select "Audio Options".

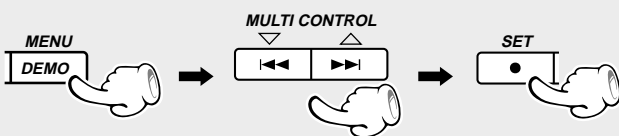

3 Select "Input level".

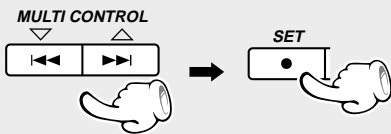

4 Select the input.

(With the NV-301, the MD/DVD input is automatically selected.)

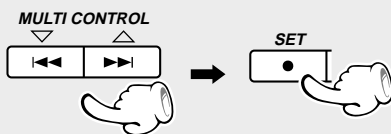

5 Adjust.

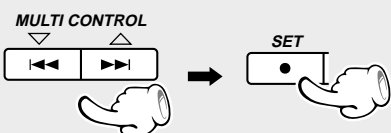

The level is decreased The level is increased

6 Save the settings.



(NV-701 only) Press VIDEO/6 ch INPUT repeatedly to switch between VIDEO 1 and VIDEO 2 input.

The following items can be selected by pressing the MULTI CONTROL keys repeatedly.

- ▶ "Recording Options"
- ▶ "Tape Options"
- ▶ "Audio Options"
- ▶ "Clock Options"
- ▶ "Surround Setup" (NV-701 only)

← "Audio Options" is scrolled in the display

Audio Option

The following items can be selected by pressing the MULTI CONTROL keys repeatedly.

- ▶ "Exbass Mode" (NV-301 only)
- ▶ "Listen Mode" (NV-701 only)
- ▶ "Balance"
- ▶ "Tone Control"
- ▶ "Input level"
- ▶ "SW level" (NV-701 only)

← "Input level" is scrolled in the display

Input level

(NV-701 only) The following items can be selected by pressing the MULTICONTROL keys repeatedly.

- ▶ "Video1"
- ▶ "Video2"

← "Adjust level" is scrolled in the display

Adjust level



Level -7 dB

- Adjustment is possible in the range of -7 to 0.

← "Press "ENTER" to save" is scrolled in the display

Press "ENTER"

Listening to music with the desired sound (NV-701 only)

This unit is compatible with Dolby Digital and DTS digital audio formats. When playing back a source that is recorded in Dolby Digital, Dolby Pro Logic, or DTS, you can enjoy cinematic quality surround sound. You can also select a DSP (Digital Soundfield Processor) to add a surround effect to standard stereo sources or even enhance multichannel surround sources.

Surround modes

DTS

The DTS multichannel audio format is available on selected CD, LD, and DVD software. DTS is a strictly digital format. The NV-701 incorporates a DTS decoder for playback of DTS CDs in this unit's CD player or for DVDs or LDs played on connected components.

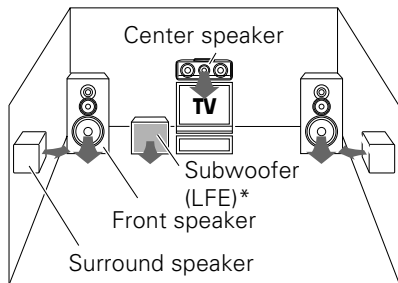

* Optional in this mode.

* LFE = Low Frequency Effects. This channel delivers separate non-directional bass signals to the subwoofer for more dynamic deep bass sound effects. DTS has a ".1" or LFE channel.

Manufactured under license from Digital Theater Systems, Inc. US Pat. No. 5,451,942 and other worldwide patents issued and pending. "DTS" and "DTS Digital Surround" are trademarks of Digital Theater Systems, Inc. © 1996 Digital Theater Systems, Inc. All rights reserved.



Dolby Digital (AC-3)

The Dolby Digital (AC-3) surround format lets you enjoy up to 5.1 channels of digital surround sound from Dolby Digital (AC-3) program sources (such as LD or DVD software marked). Compared with previous Dolby Surround, Dolby Digital (AC-3) provides even better sound quality, greater spatial accuracy, and improved dynamic range.

Although a full set of speakers (front left, right, and center, surround left and right, and a subwoofer) is required for true 5.1 channel Dolby Digital (AC-3) surround sound, NV-701 lets you enjoy Dolby Digital (AC-3) (and Dolby Surround) program sources, even if you connect only the front speakers.

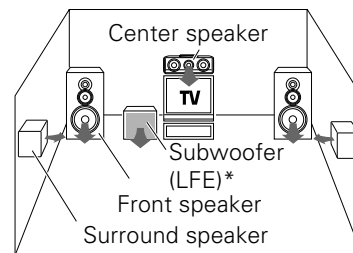

* LFE = Low Frequency Effects. This channel delivers separate non-directional bass signals to the subwoofer for more dynamic deep bass sound effects.

Although only Dolby Digital (AC-3) soundtracks incorporate a separate low frequency channel, connecting a subwoofer will also improve deep bass performance in the other surround modes.

The indication "LFE" appears in the display when a signal is being input for this channel.

Manufactured under license from Dolby Laboratories. "Dolby", "Pro Logic" and the double-D symbol are trademarks of Dolby Laboratories. Confidential Unpublished Works. ©1992-1997 Dolby Laboratories. All rights reserved.

Dolby Pro Logic

Dolby Pro Logic is a specially encoded 2-channel surround format designed to provide theater-like surround sound from Dolby Surround encoded sources (such as video and LD software marked ). This unit is equipped with a Dolby Pro Logic surround decoder to let you enjoy the wide variety of currently available Dolby Surround home video software.

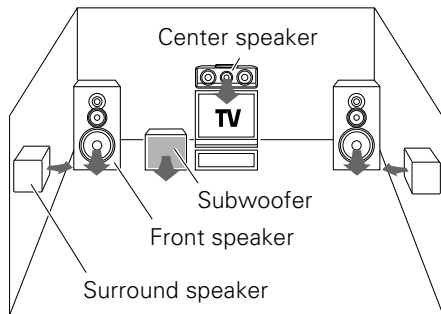

VIRTUAL SURROUND

The surround signals of Dolby Digital and DTS have been designed to provide a rich feeling of presence through usually 5 loudspeakers.

The Virtual Surround feature incorporated in this unit makes it possible to obtain a simulated surround effect using the left and right front speakers alone.

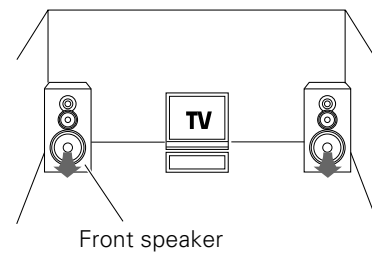

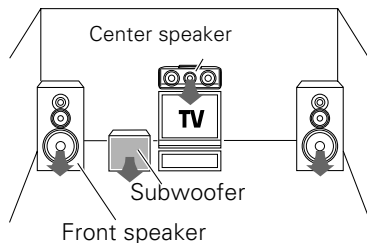

Dolby 3 Stereo

Dolby 3 Stereo is available for systems that do not have surround speakers. When in the Dolby 3 Stereo mode, the surround information is redirected to the front left and right speakers. This mode is designed for use with Dolby Surround program sources, but can also improve sound field unity for programs that are not Dolby Surround encoded. Dialog positioning and sound image definition, however, may not be as accurate when used with programs that are not Dolby Surround encoded.



Surround play (NV-701 only)

The DTS mode can be used only with CD, DVD or LD media carrying the DTS mark. DOLBY DIGITAL can be used when playing DVD or LD software bearing the  mark and when playing DOLBY DIGITAL (AC-3) format digital broadcasts (etc.). DOLBY PRO LOGIC and DOLBY 3 STEREO can be used when playing video, DVD, or LD software bearing the  mark.

Be sure to complete "Setting up for surround sound" in order to achieve the best possible surround sound. → 

1 Play the source.

2 Select the desired sound mode.

(Remote control unit only)

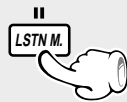

Press the CD key to start playback of a CD, or the VIDEO/6ch IN key repeatedly to select the appropriate video input.

The sound mode changes each time you press the LSTN M. (Listen Mode) key as follows:

- ▶ "Stereo"
- ▶ "Pro Logic"
- ▶ "3 Stereo"
- ▶ "Virtual"
- ▶ "Theater"
- ▶ "Arena"

Note that the only listening mode settings that can be used for playback with the current input signal type and speaker settings are available.

SOURCE \ MODE	DTS	DOLBY DIGITAL	DOLBY PRO LOGIC	DOLBY DIGITAL (2ch)	PCM
DTS	●				
DOLBY DIGITAL		●			
DOLBY PRO LOGIC			●	●	●
DOLBY 3 STEREO			●	●	●
VIRTUAL SURROUND	●	●	●	●	●
STEREO	●	●	●	●	●
THEATER	●	●	●	●	●
ARENA	●	●	●	●	●

- When listening to DTS or Dolby Digital sources, the DSP modes "VIRTUAL SURROUND", "STEREO", "THEATER", and "ARENA" can be selected to further enhance the audio.
- PCM is the standard 2-channel digital audio format recorded on CDs.

- The listening mode settings are stored separately for each input. If the input mode is set to "D – Auto", the receiver selects the optimal listening mode automatically based on the type of input signal and the speaker settings.
- When playback is started, the sound may be cut or interrupted before the input source is confirmed as Dolby Digital.
- If a Dolby Digital signal having more channels than the maximum number of playback channels available using the receiver's current settings is input, the DOWNMIX indicator lights on the display and downmixing is performed to match the number of available channels.
Example: If a Dolby Digital 5.1 signal is being input and the unit is set to the STEREO mode or if the center speaker channel is turned off.
- Noise will be produced if a DTS source is played and the Input Mode is set to "Analog" analog input. Should this occur, set the input mode to "D – Auto" or "D – Manual" for digital audio input.

Example using a Dolby Digital source signal

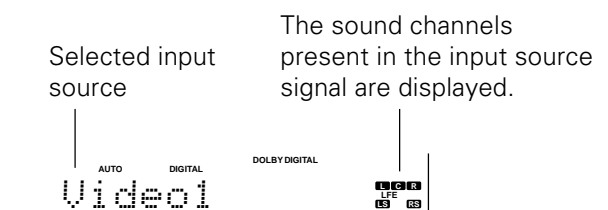

Subwoofer level adjustment (NV-701 only)

Adjusts the output level of the subwoofer speaker for greater or reduced impact of low frequency sounds.

Check that the CD player is in the stop mode.

1 Select "Audio Options".

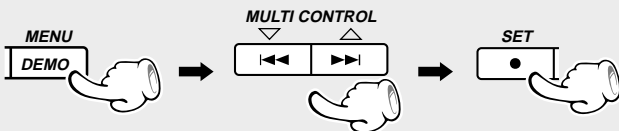

2 Select "SW level".

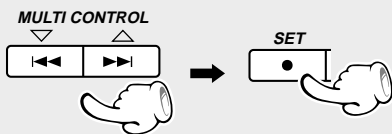

3 Adjust.

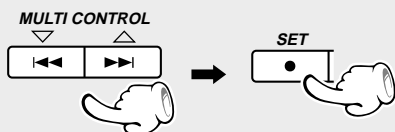

Decreases the level

Increases the level

4 Save the setting.



The following items can be selected by pressing the MULTI CONTROL keys repeatedly.

- ("CD Program Play")
- ("Recording Options")
- "Tape Options"
- **"Audio Options"**
- "Clock Options"
- "Surround Setup" (NV-701 only)

← "Audio Options" is scrolled in the display

Audio Option

The following items can be selected by pressing the MULTI CONTROL keys repeatedly.

- "Exbass Mode" (NV-301 only)
- "Listen Mode" (NV-701 only)
- "Balance"
- "Tone Control"
- "Input level"
- **"SW level" (NV-701 only)**

← "SW level" is scrolled in the display

SW level

← "Adjust Level" is scrolled in the display

Adjust Level



SW 0dB

The subwoofer level can be adjusted between -10 and +10 dB.

← "Press "ENTER" to save" is scrolled in the display

Press "ENTER

Setting up the remote control unit

You can control other components that you have using the remote control unit of this unit.

1 Press and hold the **SETUP** key.



2 Enter the code number of the component you want to control.

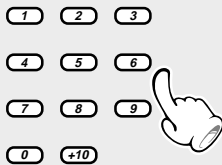

For example, to input the code of a Kenwood DVD player, enter the code 805.



3 Release the **SETUP** key.



4 Verify the code by controlling the other component.

For North America

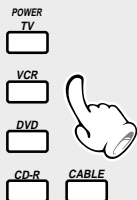

For U.K. and Europe

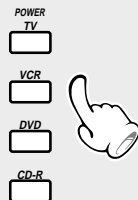

Repeat steps 1 through 4 to input the codes of your other components.

It is necessary to depress the **SETUP** key throughout the setup procedure, or the **SETUP** mode will be exited and the setup cannot be completed correctly.

Refer to the setup codes to determine the correct manufacturer's code for the component.

Except for U.K. and Europe → 63

For U.K. and Europe → 64

- The codes and controllable components may differ depending on the model and region where this unit is operated.

Verify the code by turning the component **ON** (or **OFF**) by pressing down one of the **POWER** keys for more than 2 seconds.

If the component turns on or off when the corresponding key is pressed, the code was entered correctly.

- If the component does not respond when you try to control it, repeat the procedure from step 1 and enter the next setup code on the list. Repeat this procedure until you find the code that matches the component.
- Point the remote control unit at the other component to control.
- The remote control unit may not operate other components if the batteries are weak. If you should notice a shortening in the distance from which the remote control unit can operate, replace both batteries with new ones.

When you control another component, the keys on the remote control unit do not operate to control the current input of the main unit (CD, TAPE, TUNER). In order to return to controlling the main unit with the remote control unit, press the **QUIT (DISC 3)** key.



Key functions when operating other components (NV-701 only)

Depending on the component, not all functions may be available as shown below.

TV operations

Volume	Mute	Channel selection	VIDEO SEL Input selection	TV SEL TV selection	QUIT TV operation	
ENTER	TV POWER					Numeric buttons

VCR operations

Pause	Channel selection	VIDEO SEL Input selection	QUIT VCR operation		Stop	Fast Forward / Rewind
VCR POWER				Numeric buttons		

DVD player operations

Pause	TITLE	QUIT DVD player operation	Stop		Return	Fast Forward / Reverse
Cursor control	MENU	Play/ENTER		Numeric buttons	OSD	DVD player POWER

CD-R operations

Pause	QUIT CD-R operation		Stop	Fast Forward / Reverse	Skip Forward / Back
Play	CD-R POWER	Numeric buttons			

DSS operations (For U.S.A.)

Channel
selection



QUIT DSS
operation

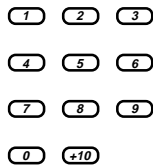

Numeric
buttons



Cursor control



MENU



ENTER



DSS receiver
POWER

Cable operations (For U.S.A.)

Volume



Channel
selection



QUIT Cable
operation

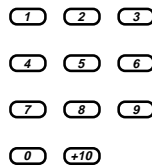

Numeric
buttons

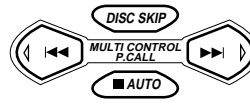

Cursor control



MENU



ENTER



OSD



Cable box
POWER

Sleep timer

The power is turned to standby mode automatically after a specified time period has elapsed.

Timer programming

- Timer playback :** Plays (or receives) the selected source during a set time range.
Use **AI timer playback** to increase the volume gradually when timer playback starts.
- Timer recording :** Records the TUNER input (NV-301 only) or the TUNER or selected VIDEO input (NV-701 only) during a set time range.

Auto Power Save

When the power is ON and neither recording nor playback is executed for 30 minutes or more, the power is switched to standby mode automatically by this function.
When the volume control is set to 0 or the mute function is on during playback, the Auto Power Save function is also activated.

Set the clock before setting the timer.
Check that the CD player is in the stop mode.



Sleep timer

Set the number of minutes after which the power is to be turned OFF.

1 Select "Clock Options".

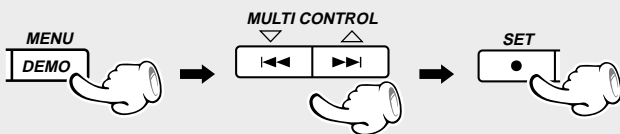

2 Select "Sleep Timer".

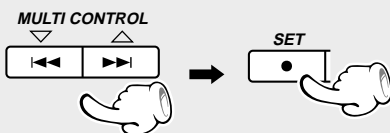

3 Set the time.

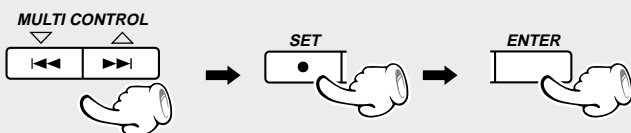

You can also set the sleep time by pressing the SLEEP key on the remote control unit. (NV-301 only)



- Each time you press the **SLEEP** key, the sleep time increases in 10-minute steps.

10 → 20 → 30 → 60 → 90 → "Sleep off"

The following items can be selected by pressing the **MULTI CONTROL** keys repeatedly.

- "CD Program Play")
- "Recording Options")
- "Tape Options"
- "Audio Options"
- "Clock Options"**
- "Surround Setup" (NV-701 only)

← "Clock Options" is scrolled in the display

Clock Option

The following items can be selected by pressing the **MULTI CONTROL** keys repeatedly.

- "Sleep Timer"**
- "Adjust Time"
- "Timer Play"
- "Auto Power Save"

Lights



Sleep 90 min

10 ↔ 20 ↔ 30 ↔ 60 ↔ 90 ↔ "Sleep off" ↔ 10 ↔ 20...

- The displayed time changes in 10-minute steps. The maximum time that can be set is 90 minutes.
- The power is turned to standby mode automatically after the set time has elapsed.
- To cancel the sleep timer, turn the power to standby mode (or OFF) or select **"Sleep off"**.

← "Press "ENTER" to save" is scrolled in the display

Press "ENTER"

Timer programming

The program timer can set either timer playback or timer recording. Either "Everyday" (executing a timer program once every day) or "One Time" (executing it only once) can be selected for each timer program. Once the time range and content of a timer program has been set, it can be activated or deactivated as desired.

● If you made a mistake during timer setting:

Press the **BACK** key to return to the previous step and restart operation from there.

Set the clock before setting the timer.

Check that the CD player is in the stop mode.

→ 19

1 Make preparations for playback (recording).

To listen to the radio

The station to be received should already be preset in advance.

→ 31

To listen to a CD

Insert a disc. (Program playback is not possible.)
Select the disc to be played (1, 2 or 3).

→ 26

To listen to a tape

Set a tape in the deck.

→ 28

Playing or recording the auxiliary input source

Make timer settings for the component connected to the AUDIO – VIDEO 2/6 CH INPUT (NV-701) or MD/DVD (NV-301) jacks.

For recording

Make preparations for recording.

→ 34

2 Adjust the listening volume.

3 Select the timer operation.

- When the timer function is used for timer recording of an input source, the speakers do not output the audio even after the unit is turned on by the timer.

For timer playback or AI timer playback

1 Select "Clock Options".

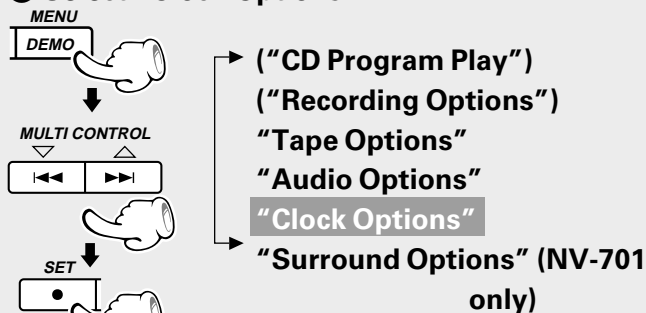

2 Select "Timer Play".

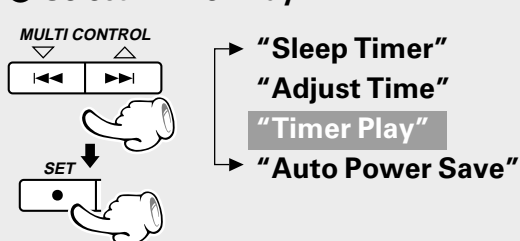

For timer recording

1 Select "Recording Options".

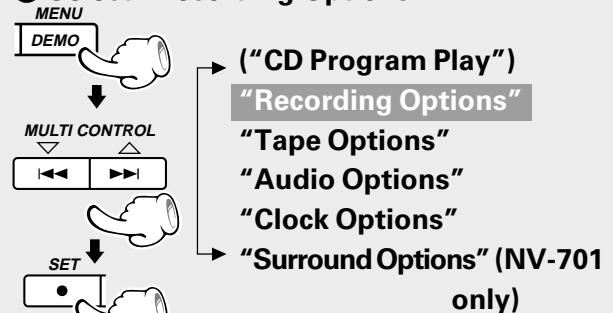

2 Select "Timer Recording".

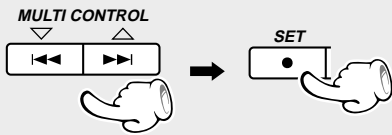

4 Select "Everyday" or "One Time".

The saved contents cannot be cleared. The contents are cleared only when they are changed.

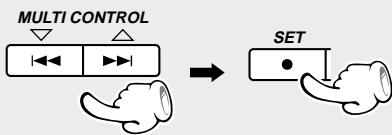
5 Enter the ON time.

The time is returned The time is advanced

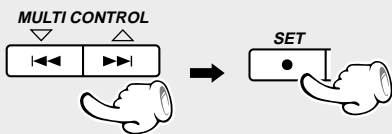
6 Enter the OFF time.

The time is returned The time is advanced

The following items can be selected by pressing the MULTI CONTROL keys repeatedly.

- "Timer off" (Canceled)
- "Everyday"
- "One Time"

- To cancel a timer operation, select "Timer off" under "Timer Play" (in case of timer playback) or "Timer Recording" (in case of timer recording).

← "Select on time" is scrolled in the display

Select on ti



(For U.K. and Europe)

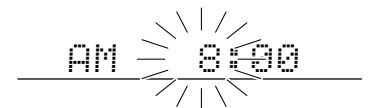

(Other countries)

- After entering the "hour", enter the "minute" with the same procedure.

← "Select off time" is scrolled in the display

Select off t

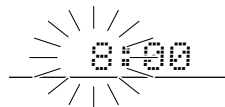

(For U.K. and Europe)

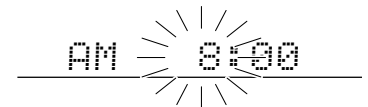

(Other countries)

- After entering the "hour", enter the "minute" with the same procedure.
- If you have set both a timer recording program and a timer playback program, leave an interval of 1 minute or more so that their time ranges do not overlap.

Continued on next page...

Auto Power Save

When the power is ON and neither recording nor playback is executed for 30 minutes or more, the power is switched off automatically by the Auto Power Save function.

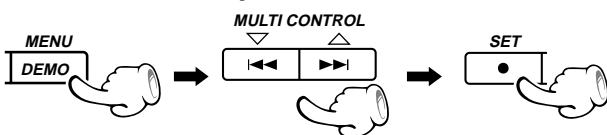
1 Select "Clock Options".

- ("CD Program Play")
- ("Recording Options")
- "Tape Options"
- "Audio Options"
- "Clock Options"
- "Surround Options" (NV-701 only)

- The auto power save operation does not occur unless the clock has already been set.
- When the TUNER or external input is selected, this function works only when the volume is set to zero or the mute function is ON.

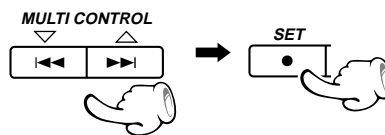
2 Select "Auto Power Save".

- "Sleep Timer"
- "Adjust Time"
- "Timer Play"
- "Auto Power Save"

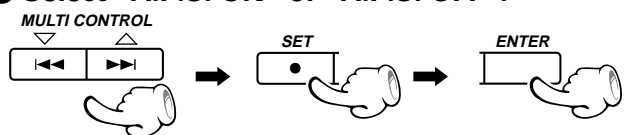
3 Select "A.P.S. ON" or "A.P.S. OFF".

- "A.P.S. OFF"
Auto Power Save is not used.
- "A.P.S. ON"
Auto Power Save is used.

7 Make the desired reservation.

For timer playback or AI timer playback

1 Select the mode.

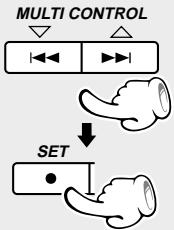

Select "Timer Play" or "AI Play".

- ① "Timer Play" Timer play
- ② "AI Play" .. Timer play with gradually increasing volume

2 Select the input source.

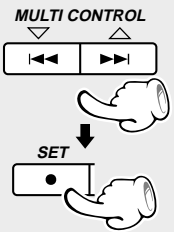

Select the source to be played.

- ① "TUNER" ... Radio
- ② "CD"
- ③ "TAPE"
- ④ "VIDEO 1" (NV-701 only)
- ⑤ "MD/DVD" (NV-301 only)
- ⑥ "VIDEO 2" (NV-701 only)

3 Select the broadcast station (only when "TUNER" is selected above).

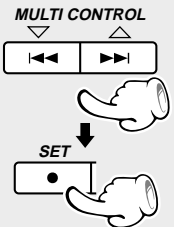

Select the preset station No.

01 87.50MHz

For timer recording

1 Select the input source.

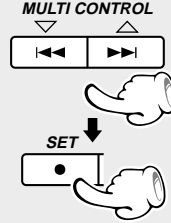

Select the recorded input source.

- ① "TUNER" Radio
- ② "VIDEO 1" (NV-701 only)
- ③ "VIDEO 2" (NV-701 only)

2 Select the broadcast station (only when TUNER is selected above).

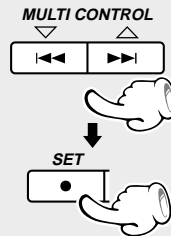

Select the preset station number

01 87.50MHz

8 Complete the setup and save the settings.



Lights



← "Press "ENTER" to save" is scrolled in the display

Press "ENTER"

Lights



9 Put the unit in standby mode.

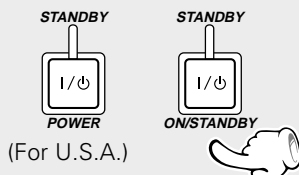

- When this unit is put in the standby mode, the STANDBY indicator lights green to indicate that a timer operation has been set.

Setup Codes (RC-NV701)

(Except for U.K. and Europe)

Use the codes on this page to set up the remote control unit to operate your other components.

TV	
BRAND NAME	SETTING NUMBER
SONY	101
GE/RCA	102
RCA	103,104,105,106,117
ZENITH	107, 108
MAGNAVOX	109
SHARP	110
PANASONIC	111, 112, 122
SAMSUNG	109
JVC	113
HITACHI	114, 115
PIONEER	116
PROSCAN	117
QUASAR	118
PHILIPS	109
SANYO	119
TOSHIBA	120
mitsubishi	121

CABLE	
BRAND NAME	SETTING NUMBER
JERROLD	201, 202
S.ATLANTA	203
ZENITH	204, 205
PIONEER	206, 207
TOCOM	208
G.I.	209
HAMLIN	210, 211
OAK	212, 213, 214
MACOM	215, 216, 217
GEMINI	218
PHILIPS	219, 220
PANASONIC	221, 222
SAMSUNG	223

DSS/CDR	
BRAND NAME	SETTING NUMBER
RCA	901
G.I.	902
ECHOSTAR	903
TOSHIBA	904
PANASONIC	905
HUGHES	906
SONY	907
HITACHI	908
PRIMESTAR	909
KENWOOD (CDR)	910
PHILIPS (CDR)	910
PIONEER (CDR)	911

VCR	
BRAND NAME	SETTING NUMBER
SONY	301,302,303,304,305,306
GE/HITACHI	307
RCA/HITACHI	308
PANASONIC	309, 310
MAGNAVOX	311, 312, 313
TOSHIBA	314
MITSUBISHI	315, 316, 317, 318
SHARP	319, 320
G.E.	321
ZENITH	322
GOLD STAR	323
JVC	324, 325, 326, 327
PHILIPS	313
HITACHI	328, 329
SANYO	330
TOSHIBA	331

DVD	
BRAND NAME	SETTING NUMBER
JVC	801
SONY	802
PIONEER	803
PANASONIC	804
KENWOOD	805, 808
TOSHIBA	806
PHILIPS	807

Setup Codes (RC-NV701E)

(For U.K. and Europe)

Use the codes on this page to set up the remote control unit to operate your other components.

TV	
BRAND NAME	SETTING NUMBER
BLAUPANKT	401
GRUNDIG	402
MIVER	401
NOKIA	403
NORDMENDE	404, 405
PHILIPS	406
SABA	404, 407
SCHNEIDER	408
TELEFUNKEN	407, 409, 410
THOMSON	411
AKAI	408
FENNER	412
FISHER	413
HITACHI	414, 415
INNO-HIT	416
IRRADIO	408
JVC	417
MAGNAVOX	406
OKANO	416
ORION	418
PANASONIC	419, 420
SAMSUNG	421
SANYO	413
SHARP	422
SONY	423, 424, 425, 426, 427
TOSHIBA	428

VCR	
BRAND NAME	SETTING NUMBER
BLAUPANKT	501
GRUNDIG	502
LOEWE	503, 504
NOKIA	505
NORDMENDE	506, 507, 508
PHILIPS	509
SABA	510
SIEMENS	502
TELEFUNKEN	511, 512
AIWA	513
BELL+HOWELL	514
CGM	514, 515
DIGITAL	515
FISHER	514
G.E.	516
HITACHI	517, 518
JVC	519
MAGNAVOX	501, 515
MITSUBISHI	520, 521, 522, 523
PANASONIC	524
PHONOLA	515
SAMSUNG	525, 526
SANYO	514
SHARP	527, 528
SONY	529, 530, 531
TOSHIBA	532

CD-R	
BRAND NAME	SETTING NUMBER
KENWOOD	901
PHILIPS	901
PIONEER	902

DVD	
BRAND NAME	SETTING NUMBER
JVC	801
SONY	802
PIONEER	803
PANASONIC	804
KENWOOD	805, 808
TOSHIBA	806
PHILIPS	807

Maintenance

Cleaning the head section

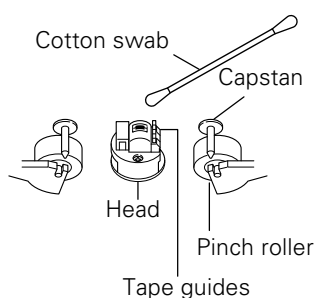

Cleaning the heads and peripheral components

For maintaining the best condition of the deck and for longer service life, always keep the heads (recording / playback / erase), capstan, and pinch roller clean.

To clean them, perform the following:

1. Open the cassette holder.
2. Using a cotton swab dipped in alcohol, clean the head (recording / playback / erase), capstan, and pinch roller carefully.

Demagnetizing the head

When the recording / playback head is magnetized, the sound quality will deteriorate. In such a case, demagnetize the head using a commercially available demagnetizer (head eraser).



There are precisely aligned parts around the heads, including the tape guides. When cleaning, pay special attention so as not to subject them to unnecessary shock.

Maintenance of the unit

When the front panel or case becomes dirty, wipe with a soft, dry cloth. Do not use thinner, benzine, alcohol, etc. for these agents may cause discoloration.

In regard to contact cleaner

Do not use contact cleaners because they could cause a malfunction. Be specially careful not to use contact cleaners containing oil, for they may deform the plastic component.

Reference

Caution on condensation

Condensation (of dew) may occur inside the unit when there is a great difference in temperature between this unit and the outside.

This unit may not function properly if condensation occurs. In this case, leave the unit for a few hours with the power left ON, and restart the operation after the condensation has dried up.

Be specially cautious against condensation in the following circumstances:

When this unit is carried from one place to another across a large difference in temperature, when the humidity in the room where this unit is installed increases, etc.

Notes related to transportation and movement

Before transporting or moving this unit, carry out the following procedures.

- 1 Turn the power ON but do not load a disc.
- 2 Press the CD (▶/||) key.
- 3 Wait a few seconds, and ensure that the display is as shown below.

CD No Disc

- 4 Wait for a few seconds then turn power off.

Memory backup function

Stored contents which are cleared immediately when power plug is unplugged from power outlet	Clock display
Stored contents which are cleared in at least a day after power plug is unplugged from power outlet	Amplifier POWER status (ON or OFF) Input selection Volume control value Balance level Surround sound settings Tuner unit Receiving band Frequency Preset stations Program timer setting contents Cassette deck unit Transport direction Dolby Noise Reduction Reverse mode

WARNING NOTICE:

IN MOST CASES IT IS AN INFRINGEMENT OF COPYRIGHT TO MAKE COPIES OF TAPES OR DISCS WITHOUT THE PERMISSION OF THE COPYRIGHT OWNERS. ANYONE WISHING TO COPY COMMERCIALY AVAILABLE TAPES OR DISC SHOULD CONTACT THE MECHANICAL COPYRIGHT PROTECTION SOCIETY LIMITED OR THE PERFORMING RIGHTS SOCIETY LIMITED.

Disc handling precautions

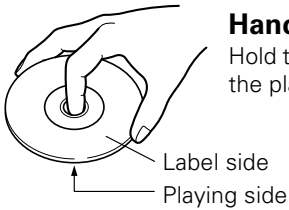

Handling

Hold the discs so that you do not touch the playing surface.

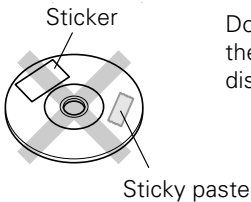

Do not attach paper or tape to either the playing side or the label side of the discs.

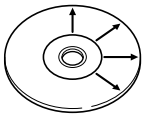

Cleaning

If fingerprints or foreign matter become attached to the disc, lightly wipe the disc with a soft cotton cloth (or similar) from the center of the disc outwards in a radial manner.

Storage

When a disc is not to be played for a long period of time, remove it from the player and store it in its case.

Never play a cracked or warped disc

During playback, the disc rotates at high speed in the player. Therefore, to avoid danger, never use a cracked or deformed disc or a disc repaired with tape or adhesive agent. Please do not use discs which are not round because they may cause a malfunction.

Disc accessories

The disc accessories (stabilizer, protection sheet, protection ring, etc.) which are marketed for improving the sound quality or protecting discs as well as the disc cleaner should not be used with this system because they may cause malfunction.

Notes on cassette tape

Safety tab (accidental erasure prevention tab)

After an important recording has been finished, break the safety tab, to prevent the recorded contents from being erased or recorded on accidentally.

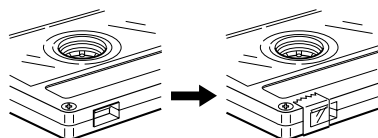
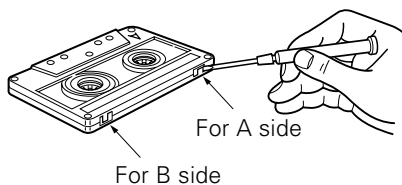

To re-record

Apply tape only to the position where the tab has been removed.

To store cassette tapes

Do not store the tapes in a place which is subject to direct sunlight, or near equipment that generates heat. Keep the cassette tapes away from any magnetic field.

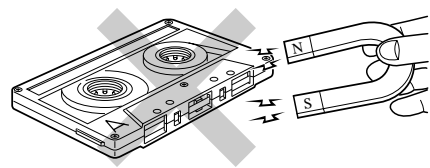

When there is slack in the tape

In such a case, insert a pencil into the reel hole and wind the reel hub to remove the slack.

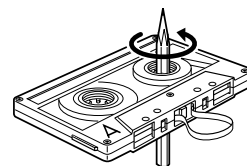

1. Cassette tapes that are longer than 100 minutes

Since tapes that are longer than 100 minutes are very thin, the tape could adhere to the pinch roller or be easily cut. It is recommended that these tapes not be used with this unit to prevent possible damage.

2. Endless tapes

Do not use an endless tape, as this could damage the mechanism of the unit.

What seems to be a malfunction is not always so. Before calling for service, check the following table according to the symptom of your trouble.

Operation to reset

The microcomputer may fall into malfunction (impossibility to operate, erroneous display, etc.) if the power cord is unplugged while power is ON or due to an external factor. In this case, execute the following procedure to reset the microcomputer and return it to normal condition.

Unplug the power cord from the power outlet then, while holding the SET (●) key depressed, plug the power cord again.



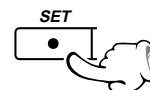

(Main unit only)







- Please note that resetting the microcomputer clears the stored contents and returns to the factory set condition.

Receiver, speakers

Symptom	Cause	Remedy
Sound is not produced.	<ul style="list-style-type: none"> ● The speaker cords are disconnected. ● The MUTE key on the remote control unit is switched ON. ● The headphone plug is inserted into the jack. 	<ul style="list-style-type: none"> ● Connect properly referring to "System connection". → 5 ● Press MUTE key to cancel muting. → 25 ● Unplug the headphone plug. → 24
"STANDBY" and "TIMER" indicators blink alternately and no sound is output.	<ul style="list-style-type: none"> ● The speaker cords are short-circuited. 	<ul style="list-style-type: none"> ● Turn the power OFF, correct the short-circuit problem and turn the power ON again.
Sound is not produced from the left or right speakers.	<ul style="list-style-type: none"> ● The speaker cords are disconnected. ● The left and right volumes are not balanced. 	<ul style="list-style-type: none"> ● Connect properly referring to "System connection". → 5 ● Adjust the left and right volume balance. → 50
The clock display blinks.	<ul style="list-style-type: none"> ● There was a power failure. ● The power cord was unplugged from the outlet. 	<ul style="list-style-type: none"> ● Adjust the present time again. → 19 ● Adjust the present time again. → 19
Timer operation is not possible.	<ul style="list-style-type: none"> ● The present time has not been adjusted or there was a power failure. ● The timer program or the timer ON/OFF time has not been set properly. 	<ul style="list-style-type: none"> ● Adjust the present time referring to "Clock adjustment". → 19 ● Check the timer program and set its ON/OFF time properly. Note that "Everyday" and "One Time" cannot be set simultaneously for a single timer program. → 60
Radio stations cannot be received.	<ul style="list-style-type: none"> ● The antennas have not been connected. ● A proper broadcasting band has not been selected. ● The frequency of the station to be received is not tuned. 	<ul style="list-style-type: none"> ● Connect antennas. → 5 ● Select a band. → 31 ● Tune to the frequency of the desired station. → 32
Sound from the MD/DVD (NV-301) or VIDEO 1/2 (NV-701) (external input) is distorted.	<ul style="list-style-type: none"> ● The input level is too high. 	<ul style="list-style-type: none"> ● Decrease the input level. → 51

Noise interferes.	<ul style="list-style-type: none"> ● Car ignition noise. ● Influence of an electric appliance. ● A TV set is installed near the system. 	<ul style="list-style-type: none"> ● Install the outdoor antenna in an apart position from the road. ● Switch the suspected electric appliance OFF. ● Increase the distance between the sets. 	→  7
No station can be received by preset call operation.	<ul style="list-style-type: none"> ● The frequency of the preset station is not tunable. ● The preset memory has been cleared because the power cord has been unplugged for a long period. 	<ul style="list-style-type: none"> ● Preset stations with tunable frequencies. ● Preset stations again. 	→  32 →  32
Demonstration starts suddenly.	<ul style="list-style-type: none"> ● The power plug was unplugged from the outlet while the power switch was ON, or there was a power failure. 	<ul style="list-style-type: none"> ● This is not a malfunction. Press the MENU (DEMO) key to cancel the demonstration. 	→  4
Power turns OFF in the middle of operation.	<ul style="list-style-type: none"> ● "A.P.S. ON" is set. 	<ul style="list-style-type: none"> ● Set it to "A.P.S. OFF". 	→  61

Cassette deck

Symptom	Cause	Remedy	
Sound cannot be produced by pressing the play key.	<ul style="list-style-type: none"> ● The head is dirty. ● The tape is wound too tight due to irregular winding. ● A nonrecorded tape is played. 	<ul style="list-style-type: none"> ● Clean the head referring to "Maintenance". ● Try another tape. ● Play a recorded tape. 	→  65
No operation occurs even when an operation key is pressed.	<ul style="list-style-type: none"> ● The cassette holder is not closed completely. ● The operation key is pressed immediately after closing the cassette holder. ● The operation key is pressed in less than 4 seconds after turning the power ON. ● A tape is not inserted in the unit. ● The tape is wound too tight due to irregular winding. ● The tape is fully wound to one of the reels. 	<ul style="list-style-type: none"> ● Close the holder completely. ● Press operations keys in more than a few seconds after closing the holder. ● Press operation keys after waiting for more than 4 seconds. ● Insert a tape. ● Try another tape. ● Change the tape transport direction or reverse the tape insertion orientation. 	→  28 →  28 →  28
The cassette holder cannot be opened by pressing the PUSH OPEN key.	<ul style="list-style-type: none"> ● The key is pressed during recording or playback. ● The microcomputer is malfunctioning due to external noise. 	<ul style="list-style-type: none"> ● Press in stop mode. ● Reset the microcomputer. 	→  67







1. With some tapes, a squeaky noise is produced when the tape is stopped automatically. This is due to the tape protection function, and not a malfunction.
2. Do not use longer tape than 100 minutes tapes, for the tape is too thin and gets easily tangled.

Sound is harsh or high frequencies are not reproduced.	<ul style="list-style-type: none"> ● The head is dirty. ● The tape is stretched or shrunk. 	<ul style="list-style-type: none"> ● Clean the head referring to "Maintenance". → 65 ● Try another tape.
Sound is distorted.	<ul style="list-style-type: none"> ● The tape being played was recorded with distorted sound. 	<ul style="list-style-type: none"> ● Try another tape.
Noise is noticeable.	<ul style="list-style-type: none"> ● The tape head is magnetized. ● External noise is induced. 	<ul style="list-style-type: none"> ● Demagnetize the head referring to "Maintenance". → 65 ● Install the system at a distance from other electric appliances and TV. ● Switch on the Tape Equalizer.
Sound vibrates.	<ul style="list-style-type: none"> ● The capstans or pinch rollers are dirty. ● The tape is wound irregularly. 	<ul style="list-style-type: none"> ● Clean the head referring to "Maintenance". → 65 ● Wind the tape again by fast forwarding, rewinding or playing from an end to the other.
Recording cannot be started by pressing the record key.	<ul style="list-style-type: none"> ● There is no tape in the tape holder. ● The recording protect tab of the cassette has been broken. ● The cassette holder is not closed completely. ● The TAPE input is selected. ● The tape is fully wound to one of the reels. 	<ul style="list-style-type: none"> ● Load a tape in the holder. → 34 ● Use a cassette with an unbroken recording protect tab or block the hole. → 66 ● Close the holder completely. → 28 ● Select the source to be recorded with the CD, TUNER, or MD/DVD (NV-301) or VIDEO 1/2 (NV-701) key. → 24 ● Change the tape transport direction or reverse the tape insertion orientation. → 28

CD player

Symptom	Cause	Remedy
A CD is placed in the player but it cannot be played.	<ul style="list-style-type: none"> ● The disc is placed upside down. ● The disc position is displaced. ● The disc is extremely dirty. ● The disc is scratched. ● Dew is condensed on the optics lens. 	<ul style="list-style-type: none"> ● Place the disc properly, with the label side facing upward. → 26 ● Place the disc properly. → 26 ● Clean the disc referring to "Handling of discs and tapes". → 66 ● Try another disc. ● Refer to "Caution on condensation" and remove the condensation by evaporation. → 65
Sound is not produced.	<ul style="list-style-type: none"> ● The disc has not been placed. ● The player is not set to the play mode. ● The disc is extremely dirty. ● The disc is scratched. 	<ul style="list-style-type: none"> ● Place a disc in the CD player. → 26 ● Press the play key. → 26 ● Clean the disc referring to "Handling of discs and tapes". → 66 ● Try another disc.
Sound skips.	<ul style="list-style-type: none"> ● The disc is dirty. ● The disc is scratched. ● The player was subjected to vibration. 	<ul style="list-style-type: none"> ● Clean the disc referring to "Handling of discs and tapes". → 66 ● Try another disc. ● Install the unit in a place not subject to vibrations.

Remote control unit

Symptom	Cause	Remedy
Remote control operation is not possible.	<ul style="list-style-type: none"> ● Batteries are exhausted. ● The remote control is too far away from the system, the controlling angle is deviated or there is an obstacle in between. ● There is no tape or CD set in the component to be played. ● An attempt is made to play the cassette deck which is recording something. ● The MULTI CONTROL setting mode is activated. 	<ul style="list-style-type: none"> ● Replace with new batteries. →  17 ● Operate the unit within the remote controllable range. ● Set a tape or CD in the component to be played. →  26 →  28 ● Wait until the recording ends. ● Cancel the MULTI CONTROL setting mode. →  18

General

Symptom	Cause	Remedy
No operation occurs when an operation key is pressed.	<ul style="list-style-type: none"> ● The MULTI CONTROL setting mode is activated. 	<ul style="list-style-type: none"> ● Cancel the MULTI CONTROL setting mode. →  18



- 1.KENWOOD follows a policy of continuous advancements in development. For this reason specifications may be changed without notice.
- 2.Sufficient performance may not be possible at very low temperatures (0°C or less).

Main unit (NV-301)

[Amplifier section]

Continuous rated power output during STEREO operation (FTC)
(U.S.A. and Canada)

70 watts per channel minimum RMS, all channels driven,
at 6 Ω from 40 Hz to 20,000 Hz with no more than 0.9 %
total harmonic distortion.

(U.K. and Europe)

1 kHz, 0.7 % T.H.D., 6 Ω (DIN) 53 W + 53 W

(Other countries)

1 kHz, 1 % T.H.D., 6 Ω (RMS) 55 W + 55 W

Effective output power during STEREO operation

(U.S.A. and Canada)

1 kHz, 10 % T.H.D., 6 Ω (RMS) 85 W + 85 W

(U.K. and Europe)

1 kHz, 10 % T.H.D., 6 Ω (RMS) 70 W + 70 W

(Other countries)

1 kHz, 10 % T.H.D., 6 Ω (RMS) 70 W + 70 W

Signal to noise ratio

Line (MD/DVD) 90 dB (IHF' 66)

Input sensitivity / impedance

Line (MD/DVD) 400 mV / 47 k Ω

Output level / impedance

Super Woofer Preout 2 V / 600 Ω

[Cassette deck section]

Track system 4-track, 2-channel stereo

Recording system AC bias
(Frequency: 105 kHz)

Heads

Playback / recording head 1

Erasing head 1

Fast winding time Approx. 110 seconds
(C-60 tape)

[CD player section]

Laser wave length 770 to 795 nm

Wow & Flutter Less than measurable Limit

Digital output (Optical) -15 dBm ~ -21 dBm
(Wave length 660 nm)

[Tuner section]

FM tuner section

Reception frequency range 87.5 MHz ~ 108 MHz

MW (AM) Tuner section

Reception frequency range

(U.S.A. and Canada) 530 kHz ~ 1700 kHz

(U.K. and Europe) 531 kHz ~ 1602 kHz

(Other countries)

9 kHz step 531 kHz ~ 1602 kHz

10 kHz step 530 kHz ~ 1610 kHz

LW Tuner section (For U.K.)

Reception frequency range 153 kHz ~ 279 kHz

[General]

Power consumption

(U.S.A. and Canada) 94 W

(U.K. and Europe) 93 W

(Australia) 93 W

(For U.S. military and other regions) 95 W

Dimensions W : 285 mm (11-1/4 in.)

H : 210 mm (8-1/4 in.)

D : 355 mm (14 in.)

Weight (net) 10.2 kg (22 lbs. 8 oz.)

Main unit (NV-701)**[Amplifier section]**

Continuous rated power output during STEREO operation (FTC)
(Front channels only) (For U.S.A., Canada, and U.S. military)

50 watts per channel minimum RMS, all channels driven,
at 6 Ω from 40 Hz to 20,000 Hz with no more than 0.9 %
total harmonic distortion.

(U.K. and Europe)

1 kHz, 0.7 % T.H.D., 6 Ω (DIN) 35 W + 35 W

(Other countries)

1 kHz, 1 % T.H.D., 6 Ω (RMS) 38 W + 38 W

Effective output power during STEREO operation

(U.S.A. and Canada)

FRONT (1 kHz, 10 % T.H.D., 6 Ω) (RMS) 50 W + 50 W

SUB WOOFER (65 Hz, 10 % T.H.D., 6 Ω) (RMS) 50 W

(U.K. and Europe)

FRONT (1 kHz, 10 % T.H.D., 6 Ω) (RMS) 50 W + 50 W

SUB WOOFER (65 Hz, 10 % T.H.D., 6 Ω) (RMS) 50 W

(U.S. military)

FRONT (1 kHz, 10 % T.H.D., 6 Ω) (RMS) 50 W + 50 W

SUB WOOFER (65 Hz, 10 % T.H.D., 6 Ω) (RMS) 50 W

(Other countries) (Front channels only)

FRONT (1 kHz, 10 % T.H.D., 6 Ω) (RMS) 70 W + 70 W

Effective output power during SURROUND operation

(One channel driven)

FRONT (1 kHz, 10 % T.H.D., 6 Ω) (RMS) 50 W + 50 W

CENTER (1 kHz, 10 % T.H.D., 6 Ω) (RMS) 50 W

SURROUND (1 kHz, 10 % T.H.D., 6 Ω) (RMS) 50 W + 50 W

SUB WOOFER (65 Hz, 10 % T.H.D., 6 Ω) (RMS) 50 W

Signal to noise ratio

LINE (VIDEO) 90 dB (IHF' 66)

Input sensitivity / impedance

LINE (VIDEO) 400 mV / 47 k Ω

Output level / impedance

REC OUT (VIDEO1) 400 mV / 47 k Ω

[Video]

Input level / impedance

VIDEO (composite) 1 Vp-p / 75 Ω

Output level / impedance

VIDEO (composite) 1 Vp-p / 75 Ω

[Digital]

Sampling frequency 32 kHz, 44.1 kHz, 48 kHz

Input level / impedance

Coaxial (VIDEO 1) 0.5 Vp-p / 75 Ω

Optical (VIDEO 2) -15 dBm ~ -21 dBm (660 nm \pm 30nm)

Output level / impedance

Optical -15 dBm ~ -21 dBm (660 nm \pm 30nm)

[Cassette deck section]

Track system 4-track, 2-channel stereo

Recording system AC bias

(Frequency: 105 kHz)

Heads

Playback / recording head 1

Erasing head 1

Fast winding time Approx. 110 seconds

(C-60 tape)

[CD player section]

Laser wave length 770 to 795 nm

Wow & Flutter Less than measurable Limit

[Tuner section]

FM tuner section

Reception frequency range 87.5 MHz ~ 108 MHz

MW (AM) Tuner section

Reception frequency range

(U.S.A. and Canada) 530 kHz ~ 1700 kHz

(U.K. and Europe) 531 kHz ~ 1602 kHz

(Other countries)

9 kHz step 531 kHz ~ 1602 kHz

10 kHz step 530 kHz ~ 1610 kHz

LW Tuner section (For U.K.)

Reception frequency range 153 kHz ~ 279 kHz

[General]

Power consumption

(U.S.A. and Canada) 158 W

(U.K. and Europe) 109 W

(Australia) 109 W

(For U.S. military and other regions) 157 W

Dimension W : 285 mm (11-1/4 in.)

H : 210 mm (8-1/4 in.)

D : 355 mm (14 in.)

Weight (net) 10.7 kg (23 lbs. 9 oz.)

Speakers

[Front Speakers]

Enclosure Passive radiator, floor type
(magnetically shielded)

Speaker configuration

Woofer 120 mm (5 in.), paper cone type
Tweeter 50 mm (2 in.), paper cone type
Passive radiator 125 mm (5 in.)

Impedance 6 Ω
Peak input level 120 W
Dimensions W : 182 mm (7-3/16 in.)
H : 360 mm (14-3/16 in.)
D : 268 mm (10-9/16 in.)
Weight (net) 4.3 kg (9 lbs. 8 oz.) (1 piece)

[Center speaker] (NV-701 only)

Enclosure Acoustic air suspension
(magnetically shielded)

Speaker configuration

Full range speaker 80 mm (3 in.) x2, paper cone type
Impedance 6 Ω
Peak input level 80 W
Dimensions W : 280 mm (11 in.)
H : 130 mm (5-1/8 in.)
D : 166 mm (6-9/16 in.)
Weight (net) 2.3 kg (5 lbs. 1 oz.)

[Surround speakers] (NV-701 only)

Enclosure Acoustic air suspension

Speaker configuration

Full range speaker 100 mm (4 in.), paper cone type
Impedance 6 Ω
Peak input level 80 W
Dimensions W : 177 mm (6-15/16 in.)
H : 150 mm (5-7/8 in.)
D : 166 mm (6-9/16 in.)
Weight (net) 1.3 kg (2 lbs. 14 oz.) (1 piece)

[Subwoofer] (NV-701 only)

Enclosure Bass-reflex

Speaker configuration

Woofer 160 mm (6.5 in.), paper cone type
Impedance 6 Ω
Peak input level 80 W
Dimensions W : 280 mm (11 in.)
H : 200 mm (7-7/8 in.)
D : 345 mm (13-9/16 in.)
Weight (net) 5.6 kg (12 lbs. 5 oz.)

This instruction manual is used to describe multiple models.
 Model availability and features (functions) may differ depending on the country and sales area.



	NV-301	NV-701
SPEAKERS terminals → 6	YES	YES
RDS capability → 42	YES (For U.K. and Europe)	YES (For U.K. and Europe)
DIGITAL OUT OPTICAL jack → 8 → 9	YES	YES
DIGITAL IN (OPTICAL and COAXIAL) → 9 → 10	NO	YES
Internal DTS and Dolby Digital decoding → 52	NO	YES
Discreet 6-channel input → 10 → 25	NO	YES
Remote control of other component capability → 56	NO	YES

KENWOOD

For your records

Record the serial number, found on the back of the unit, in the spaces designated on the warranty card, and in the space provided below. Refer to the model and serial numbers whenever you call upon your dealer for information or service on this product.

Model _____ Serial Number _____

Free Manuals Download Website

<http://myh66.com>

<http://usermanuals.us>

<http://www.somanuals.com>

<http://www.4manuals.cc>

<http://www.manual-lib.com>

<http://www.404manual.com>

<http://www.luxmanual.com>

<http://aubethermostatmanual.com>

Golf course search by state

<http://golfingnear.com>

Email search by domain

<http://emailbydomain.com>

Auto manuals search

<http://auto.somanuals.com>

TV manuals search

<http://tv.somanuals.com>