

KENWOOD

CX-SR10

Sirius® Satellite Antenna Installation Manual



Introduction

Your Sirius satellite antenna, approved by Sirius Satellite Radio, Inc., has been specially designed to receive signals from Sirius' three satellites and Sirius' network of ground-based "repeater" transmitters.

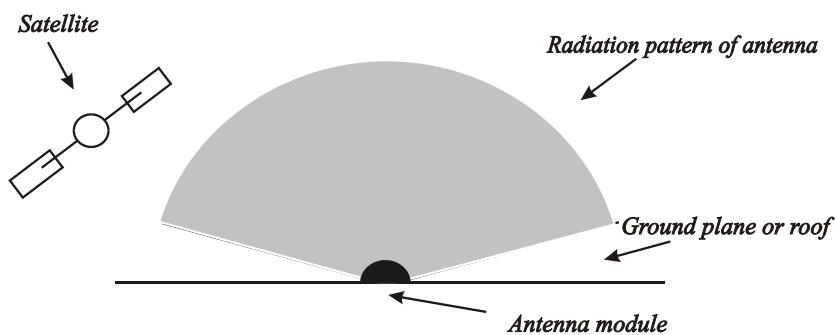

Figure 1: Ideal reception pattern

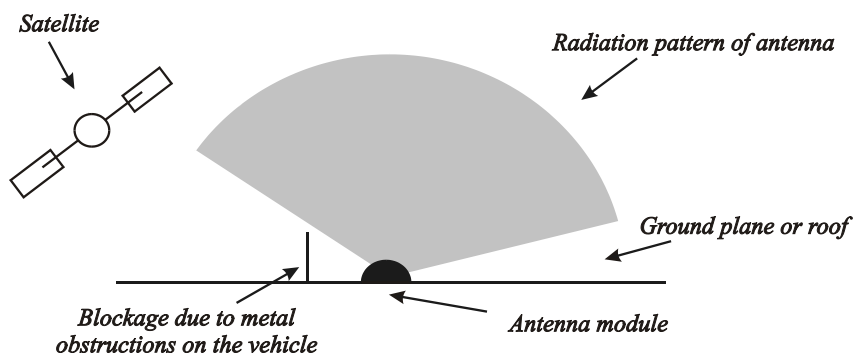

Figure 2: Effect of obstruction on reception pattern

Roof-Mount Antenna



Figure 3: CX-SR10 low profile roof-mount Sirius antenna

Environmental data:

Functional operating temperature	-40 to +105 degC
Storage temperature	-45 to +120 degC
Humidity	Power wash proof

Mechanical data:

Shape	"Beveled teardrop"
Color	Black
Dimensions	95mm x 70mm x 38mm (approx)
Weight	150 grams (5.25oz) (excl. cables)
Cables	4 meters (13 feet) micro low loss
Connectors	2 x FAKRA / SMB (keyed per specification)
Mounting	Acrylic foam adhesive pads
Cover	Impact resistant glass filled nylon (paintable)

Electrical data:

Sirius	Per specification Sirius RX000002-010300
Peak Gain (SAT)	6 dBic
3 dB beam width (SAT)	130 degree
4 dB beam width (SAT)	140 degree
Noise figure (SAT)	0.7 dB
Peak Gain (Ter.)	6 dBi
Noise figure (Ter.)	1.1 dB

General Instructions

Satellite antennas are extremely sensitive and finely specified to facilitate reception of satellite signals under a variety of conditions across the whole of North America. It is important to read these instructions carefully to ensure that the antenna is mounted properly in the best location in order to provide optimum reception quality.

Mounting location

The satellite antenna should be mounted horizontally on a metal surface measuring at least 18 inches by 18 inches. The best reception quality is achieved at the highest point of the vehicle (i.e. the roof) but the trunk lid is an alternate location for convertibles and for some sedans.

It is important that the antenna has a clear "view" to the satellites and ground-based repeaters and should therefore be mounted in an unobstructed location (i.e. clear of roof racks, sunroofs, other antennas). Use the table below as a guide for the required distance between the antenna placement and a possible obstruction with a given height.

Mount the antenna this far away	From an obstruction this high
12"	4"
18"	6"
24"	8"
30"	10"

(Glass sunroofs, which open outwards and cover the rear roof area, should not affect the location of the antenna module).

Installation temperature

Installation should be carried out when conditions are at room temperature or above. Firstly, colder temperatures could affect the curing time of the antenna module's adhesive. Secondly, when mounting the antenna module on a sedan, it will be easier to work with the rubber molding around the window.

Shortening the antenna "tail"

The antenna module is supplied with a 6 inch tail. For vehicles with flat roofs (SUVs, Mini-vans) and for convertibles, it is possible to shorten the tail by up to 2 inches.

NOTE: For vehicles with a sloping roof, or if the module is mounted on the trunk of a convertible, the tail should not be shortened!

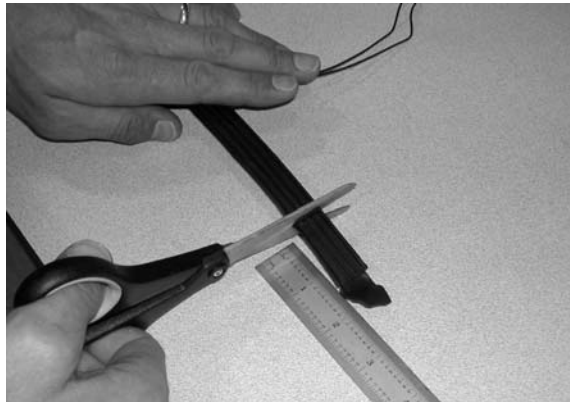

Figure 4: Shortening the antenna tail

After the precise length of the tail has been determined, the adhesive strip may be cut to length and applied to the antenna tail.



Figure 5: Applying adhesive tape

Removing the antenna

The antenna module may be removed, using a nylon cord (e.g. fishing line) to cut through the adhesive pad between the antenna module and the vehicle. Work from the front to the tail in a side-to-side cutting motion. Any remaining adhesive may be removed with an appropriate cleaner.

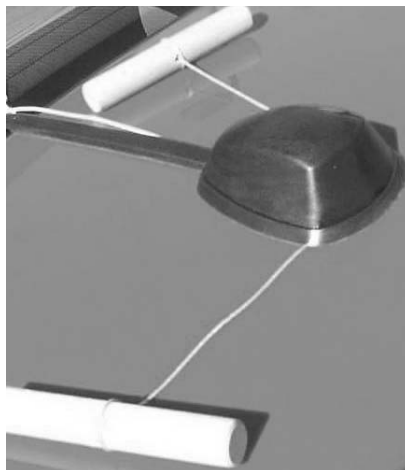

Figure 6: Removing antenna

Installing on Sedans

The antenna module should be located along the centerline of the roof, at least 4 inches from the rear window.



Figure 7: Installed antenna

The antenna cables should be tucked and routed underneath the rubber molding around the rear window and into the trunk.

Note: Routing the cable in the window molding will not affect the sealing of the window.

- 1. Clean the general area where the antenna is to be mounted (using the provided alcohol wipe).**
- 2. Identify and mark the precise location of the antenna module.**
- 3. Peel off protective liner from adhesive pads.**
- 4. Starting with the tail in position, work towards the module, applying pressure of approximately 12 psi for a minimum of 15 seconds.**

Note: Maximum adhesion occurs within 72 hours, during which time car washes and other contact with the antenna should be avoided.

- 5. Carefully tuck the cables under the rubber molding, working from the tail of the antenna, around the window and into the trunk area.**

(A flat tip dental pick or cotter-pin remover is ideal for lifting the rubber molding and tucking in the cables.)

Note: Determine whether there is enough space under the molding to conceal both cables, in which case they may be run together. If not, route a single cable around each side of the window.

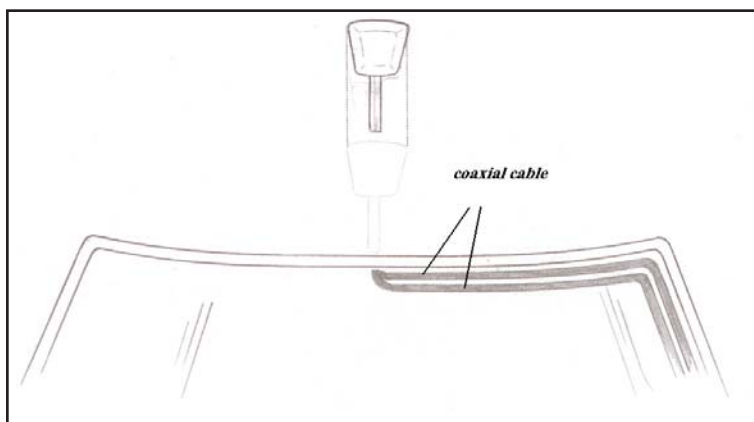

Figure 8: Cables routed together

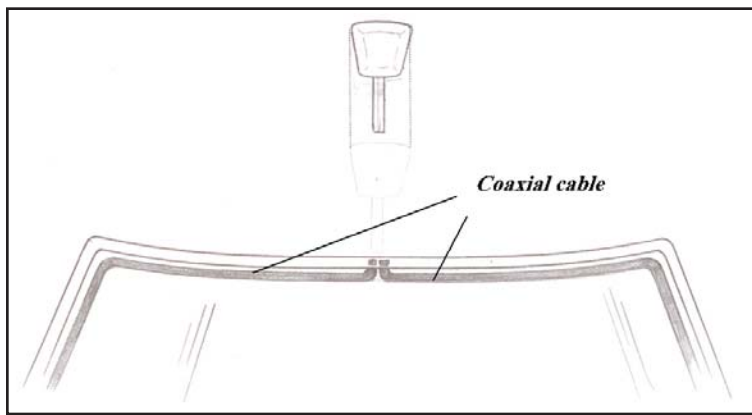

Figure 9: Cables routed separately

Two types of window moldings (Outside and Encapsulated) are used on most vehicles. Both are suitable for concealing the antenna cable.

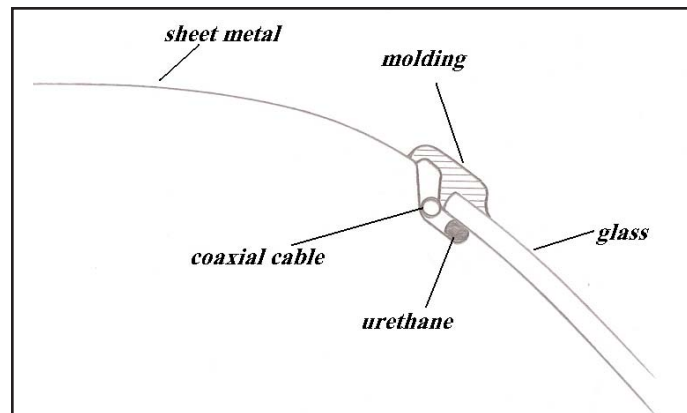

Figure 10: Outside rubber molding (most common)

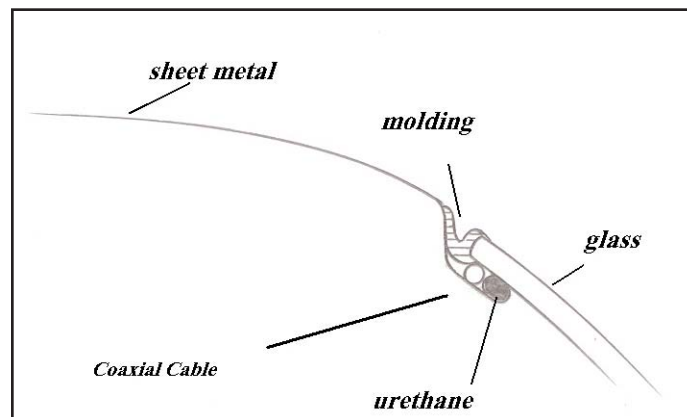

Figure 11: Encapsulated molding (less common)

Note: The window molding will be more flexible and easier to work with at room temperature or above. Ensure the molding is clean, and if necessary apply a small amount of oil to make the process easier.

It is important that the coaxial cable does not become damaged or kinked during the installation procedure.

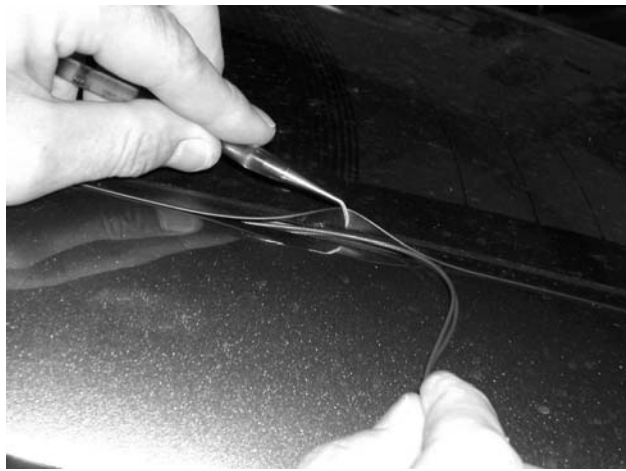

Figure 12: Cables routed in standard molding

6. Route the cable from the lowest point of the rear window into the trunk area. Take advantage of any existing cable channel or wiring conduit.

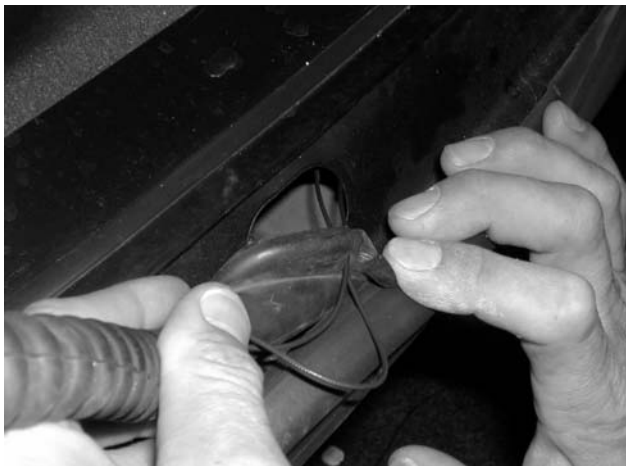

Figure 13: Entering the trunk through cable channel

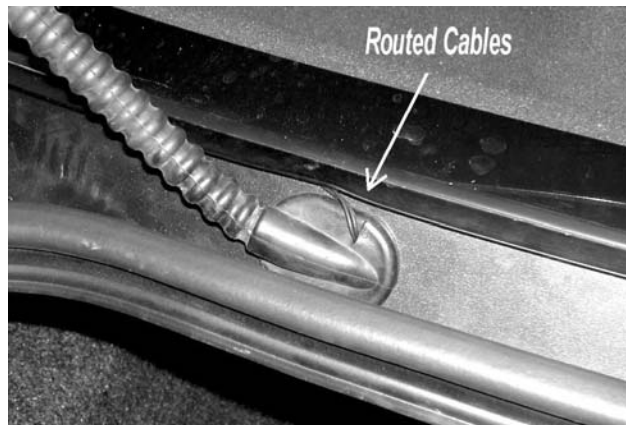

Figure 14 Cables routed directly through the molding and through the cable channel to the interior

7. If there is no suitable cable channel, the cable may be routed directly from the window molding to the right or left corner of the trunk.



Figure 15: Cable routing along the trunk rubber molding

It may be necessary to remove the plastic housings from the antenna connectors in order to feed the cables through narrow openings. Note: Remember to reconnect the correct housing to its corresponding cable.

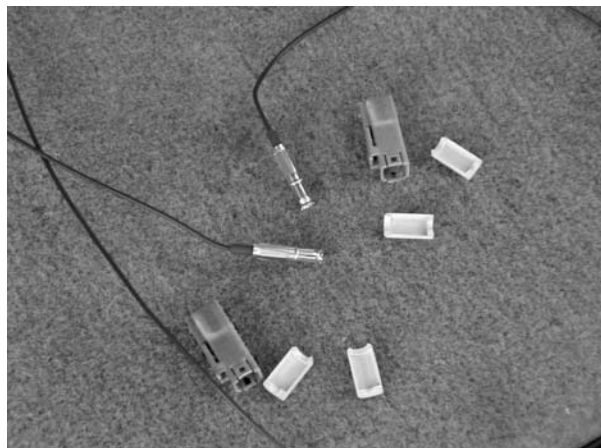

Figure 16 Removing connector housings

Most Sirius receivers (including the Kenwood KTC-SR901) have two antenna inputs with the same color-coding as the antenna cable - white = terrestrial; blue = satellite. Simply plug the cable with the blue connector into the blue input and the cable with the white connector into the white input.



Figure 17: Connecting the Sirius receiver

However, some receivers use only one SMB connector, in which case the plastic housing must be permanently removed and the connector inserted directly into the receiver.

Installing on Convertibles

On convertibles the antenna module should be located on the centerline of the trunk approximately 6 inches from the rear window.

WARNING: Mounting the antenna on the trunk will only work with convertibles. For all other types of vehicles mount the antenna on the roof.



Figure 18: Mounted on trunk of convertible

1. Follow steps 1 to 4 under "Installing on Sedans" to attach the antenna module to the vehicle.
2. Route the cable from the rim further underneath the lid (use some telephone wire clips) to the cable channel. Attach the cable to the cable channel with some zip ties.



Figure 19: Routing the cables around the trunk lid rim



Figure 20: Attaching the cable to the cable channel

3. Drill a small hole or cut a gap into the rubber sleeve and lead the cable through the interior trim to the receiver.



Figure 21: Entering the interior through the cable channel

Note: Many convertibles have composite trunk lids. In such cases it will be necessary to create a metal "ground plane". This can be done by gluing aluminum foil (at least 2 square feet) underneath the trunk lid between the composite lid and the liner.

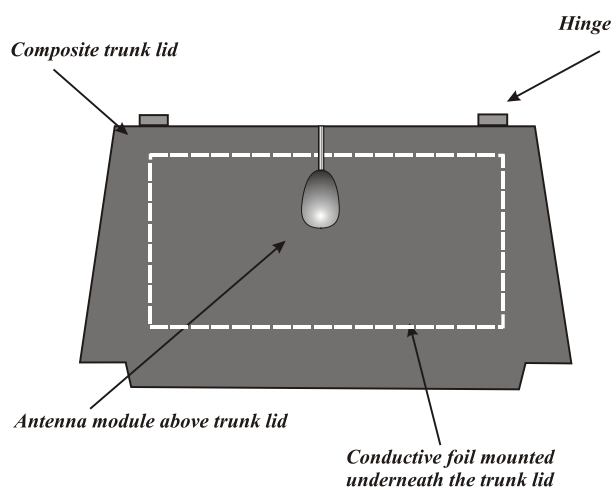

Figure 22: Antenna mounting on a composite trunk lid

It is important that the coaxial cable does not become damaged or kinked during the installation procedure.

Installing on SUVs, Minivans and 5-Door Vehicles

The antenna module should be located on the centerline of the roof, not less than 4 inches from the gap between the roof and tailgate:



Figure 23: Minivan with Antenna Module

Note the following:

- If the vehicle is equipped with a roof rack, the crossbar should be placed at least 6 inches away from the antenna module.

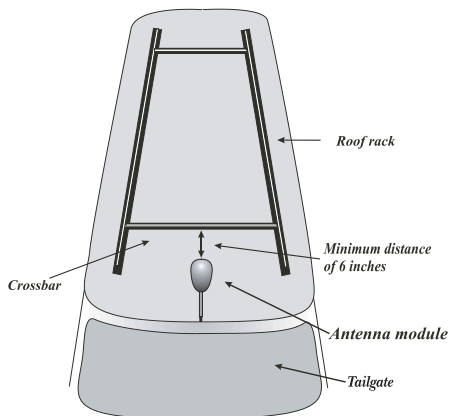

Figure 24: Preferred mounting location

- It may be necessary to locate the antenna to the right or left of center in order to avoid "skid ribs" or brakelight.



Figure 25: "Skid Ribs" and brakelight

Other roofs have a brakelight in the back and the cable may be routed through the brakelight (see "Mounting on Pickup Trucks").

1. Follow steps 1 to 4 under "Mounting on Sedans" to attach the antenna module to the vehicle.

2. Route the cable between the roof and the tailgate to the inside. Take advantage of any existing cable channel or wiring conduit.
3. There are two alternative methods to route the cable under the headliner and to the receiver:
 - a. The cable may be routed to the cable channel, lift up the channel and go through the small opening and push the cable directly between sheet metal and headliner. This option is recommended. The cable and the receiver may be concealed behind the interior trim in the back of the vehicle.



Figure 26: Cable routed through roof end and tailgate under the rubber molding

- b. Alternatively, the cable may be hidden under the rubber molding following the metal groove underneath the molding to the interior.



Figure 27: Hiding the cable under the rubber molding



Figure 28: Going inside under the interior trim

It is important that the coaxial cable does not become damaged or kinked during the installation procedure.

Mounting on Pickup Trucks

The antenna module should be mounted on the centerline of the roof approximately 4 inches from the rear of the cab. The cables may be routed into the cab through the brake light cavity.



Figure 29: Pickup truck with antenna module

1. Follow steps 1 to 4 under "Installing on Sedans" to attach the antenna module to the vehicle.

Note: If the molding of the brakelight is made of rigid plastic/composite, it may be necessary to drill a small hole or slot to route the cable. Seal the hole with silicone compound after the installation.



Figure 30: Brakelight cavity



Figure 31: Completed installation

2. Route the cable through the interior trim to where the receiver is located.
3. See Figure 19 under "Installing on Sedans" for connection to the receiver.

It is important that the coaxial cable does not become damaged or kinked during the installation procedure.

KENWOOD

Internet

www.kenwoodusa.com

E-mail

inquiry@kenwoodusa.com

Telephone

1-800-KENWOOD

Main Office

P.O. Box 22745
Long Beach, CA 90801-5745

Free Manuals Download Website

<http://myh66.com>

<http://usermanuals.us>

<http://www.somanuals.com>

<http://www.4manuals.cc>

<http://www.manual-lib.com>

<http://www.404manual.com>

<http://www.luxmanual.com>

<http://aubethermostatmanual.com>

Golf course search by state

<http://golfingnear.com>

Email search by domain

<http://emailbydomain.com>

Auto manuals search

<http://auto.somanuals.com>

TV manuals search

<http://tv.somanuals.com>