

KENWOOD

INSTRUCTION MANUAL

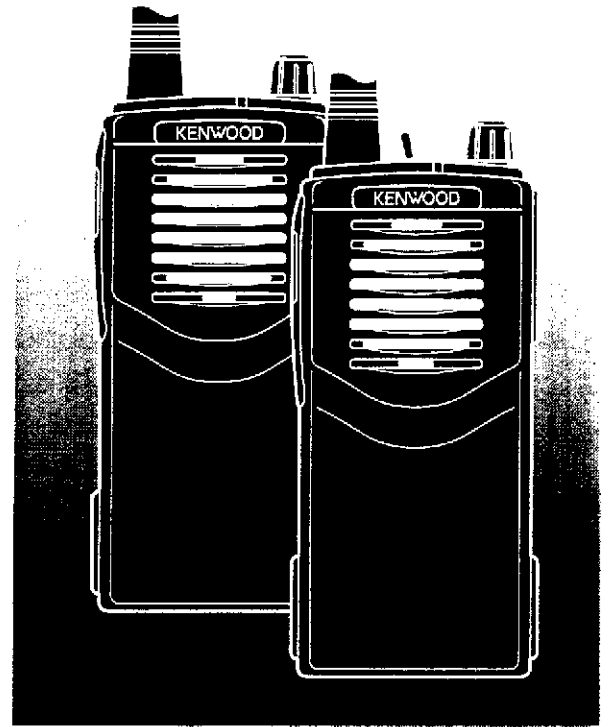

VHF FM TRANSCEIVER (TK-2100)

ProTalk™ VHF

UHF FM TRANSCEIVER (TK-3100)

ProTalk™ UHF

KENWOOD CORPORATION

© B62-0950-30 (K)
09 08 07 06 05 04 03

INTRODUCTION

KENWOOD welcomes you to the Business Radio Service (BRS). Your **KENWOOD** 2-way Business Radio is called a “transceiver”, meaning “transmitter and receiver”.

For your convenience, this transceiver is equipped with automatic squelch control which quiets your transceiver when you are not receiving any calls. For your privacy, this transceiver provides you with a feature called Quiet Talk (QT). This feature allows you to use the same channel as others without having to listen to their conversations. Another feature of this transceiver is its sliding battery pack which simplifies installing, removing, and charging.

Your transceiver provides safety and convenience almost anywhere, indoors or out. It follows both EMI (Electromagnetic Interference) and military standards. The communications range depends on your location, and can be up to 5 miles (8 km) in open areas (refer to the chart below for talk ranges).

This **KENWOOD** transceiver is a precision device. Treat it with care, and you will enjoy years of reliable operation.

Conditions	ProTalk™ VHF range	ProTalk™ UHF range
Open locations (no obstructions)	Up to 5 miles (8 km)	Up to 5 miles (8 km)
Residential areas (near buildings)	Up to 2.5 miles (4 km)	Up to 2 miles (3 km)
• In steel/ concrete reinforced buildings • In high rises	• Up to 180,000 sq. ft (55,000 sq. m) • Up to 10 floors	• Up to 250,000 sq. ft (76,000 sq. m) • Up to 20 floors

Note: The listed ranges are based on field testing and may vary with individual transceivers.

FCC LICENSE INFORMATION

Your **KENWOOD** radio operates on communications frequencies which are subject to FCC (Federal Communications Commission) Rules & Regulations. FCC Rules require that all operators using Private Land Mobile radio frequencies obtain a radio license before operating their equipment. Application for license must be made on FCC form 600, and schedules D, E, and G.

FAX: Forms can be obtained by fax from the FCC Fax-On-Demand system. Call 1-202-418-0177 from your fax machine and request document number 000600 for the form, schedules, and instructions.

MAIL: Forms can be ordered by telephone, and will be sent to you by first class mail. Call the FCC Forms Hotline at 1-800-418-FORM (1-800-418-3676).

INTERNET: Form 600 and instructions can be downloaded from the FCC Forms website at <http://www.fcc.gov/formpage.html>

Before filling out your Form 600 application Technical Data section, you must decide which frequency (or frequencies) you will operate on. See the frequency charts on page 9.

QUESTIONS? Call the FCC for license application questions at 1-888-CALL-FCC (1-888-225-5322).

MODELS COVERED BY THIS MANUAL

ProTalk™ VHF (TK-2100):

- 1 channel VHF FM Transceiver/
2 channel VHF FM Transceiver

ProTalk™ UHF (TK-3100):

- 1 channel UHF FM Transceiver/
2 channel UHF FM Transceiver

NOTICES TO THE USER

- ◆ *GOVERNMENT LAW PROHIBITS THE OPERATION OF UNLICENSED RADIO TRANSMITTERS WITHIN THE TERRITORIES UNDER GOVERNMENT CONTROL.*
- ◆ *ILLEGAL OPERATION IS PUNISHABLE BY FINE OR IMPRISONMENT OR BOTH.*

SAFETY: It is important that the operator is aware of, and understands, hazards common to the operation of any transceiver.

PRECAUTIONS

- Refer service to qualified technicians only.
- Do not operate your transceiver or charge your battery pack in an explosive atmosphere (gases, dust, fumes, etc.).
- Turn OFF your transceiver while taking on fuel, or while parked in gasoline service stations.
- Do not modify this transceiver for any reason.
- Do not expose the transceiver to long periods of direct sunlight, nor place it close to heating appliances.
- Do not place the transceiver in excessively dusty, humid, and wet areas, nor on unstable surfaces.

One or more of the following statements may be applicable:

FCC WARNING

This equipment generates or uses radio frequency energy. Changes or modifications to this equipment may cause harmful interference unless the modifications are expressly approved in the instruction manual. The user could lose the authority to operate this equipment if an unauthorized change or modification is made.

INFORMATION TO THE DIGITAL DEVICE USER REQUIRED BY THE FCC

This equipment has been tested and found to comply with the limits for a Class B digital device, pursuant to Part 15 of the FCC Rules. These limits are designed to provide reasonable protection against harmful interference in a residential installation.

This equipment generates, uses and can generate radio frequency energy and, if not installed and used in accordance with the instructions, may cause harmful interference to radio communications. However, there is no guarantee that the interference will not occur in a particular installation. If this equipment does cause harmful interference to radio or television reception, which can be determined by turning the equipment off and on, the user is encouraged to try to correct the interference by one or more of the following measures:

- *Reorient or relocate the receiving antenna.*
- *Increase the separation between the equipment and receiver.*
- *Connect the equipment to an outlet on a circuit different from that to which the receiver is connected.*
- *Consult the dealer for technical assistance.*

ATTENTION (U.S.A. Only):



The RBRC Recycle seal found on **KENWOOD** nickel-cadmium (Ni-Cd) battery packs indicates **KENWOOD's** voluntary participation in an industry program to collect and recycle Ni-Cd batteries after their operating life has expired. The RBRC program is an alternative to disposing Ni-Cd batteries with your regular refuse or in municipal waste streams, which is illegal in some areas.

For information on Ni-Cd battery recycling in your area, call (toll free) 1-800-8-BATTERY (1-800-822-8837).

KENWOOD's involvement in this program is part of our commitment to preserve our environment and conserve our natural resources.

CONTENTS

UNPACKING AND CHECKING EQUIPMENT	1
Supplied Accessories	1
PREPARATION	3
Installing/ Removing the NiCd Battery Pack	3
Installing the Antenna	4
Installing the Belt Clip	4
Installing the Cover over the Speaker/ Microphone Jacks	5
Installing the (Optional) Speaker/ Microphone	5
GETTING ACQUAINTED	6
OPERATING BASICS	7
CHANNEL FREQUENCY SELECTION	8
QUIET TALK (QT)	11
QT Tone Setup	12
CHANNEL SETTING CONFIRMATION	16
Frequency Confirmation	16
QT Tone Confirmation	16
Confirmation Beep Patterns	17
Reference Tables	17
TRANSCIVER FUNCTIONS	18
Time-out Timer (TOT)	18
Battery Save	18
Low Battery Warning	18
CHARGING THE NiCd BATTERY PACK	19
OPTIONAL ACCESSORIES	21
TROUBLESHOOTING GUIDE	22

UNPACKING AND CHECKING EQUIPMENT

Carefully unpack the transceiver. We recommend that you identify the items listed in the following table before discarding the packing material. If any items have been damaged during shipment, file a claim with the carrier immediately.

■ Supplied Accessories

Item		Part Number	Quantity
Antenna	ProTalk™ VHF	T90-0695-X5	1
	ProTalk™ UHF	T90-0694-X5	
Battery charger		W08-0552-X5	1
AC adaptor		W08-0551-X5	1
NiCd battery pack (KNB-14)		W09-0939-X5	1
Speaker/ microphone jack cover		B09-0351-X3	1
Speaker/ microphone locking bracket		J21-4493-X4	1
Belt clip		J29-0624-03	1
Screw set		N99-0396-X5	1
Warranty card		—	1
Instruction manual		B62-0950-XX	1

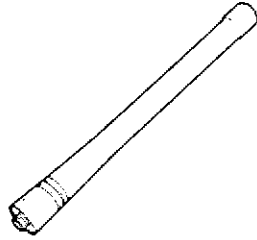

Antenna
(ProTalk™ VHF)

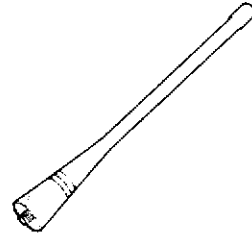

Antenna
(ProTalk™ UHF)

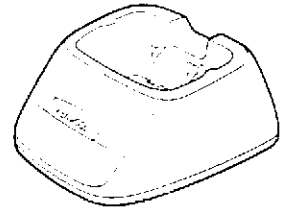

Battery charger

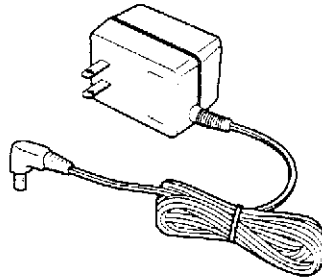

AC adaptor

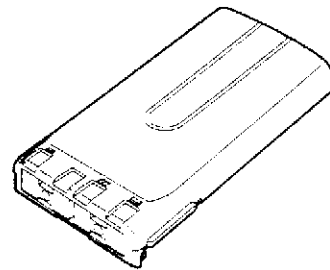

NiCd battery
pack (KNB-14)



Speaker/ microphone
jack cover

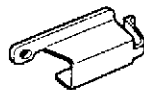

Speaker/ microphone
locking bracket

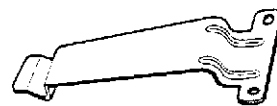

Belt clip



Screw set

PREPARATION

■ Installing/ Removing the NiCd Battery Pack

The battery pack is not charged at the factory; charge it before use {page 19}.

Average battery pack life:

- KNB-14 (supplied): 8 hours (ProTalk™ VHF/ UHF)
- KNB-15A (optional): 10 hours (ProTalk™ VHF/ UHF)

Average times are calculated using 5% transmit time, 5% receive time, and 90% standby time.

CAUTION:

- ◆ *DO NOT SHORT THE BATTERY TERMINALS OR DISPOSE OF THE BATTERY BY FIRE.*
- ◆ *NEVER ATTEMPT TO REMOVE THE CASING FROM THE BATTERY PACK.*

1 Match the four grooves of the battery pack with the corresponding guides on the back of the transceiver.

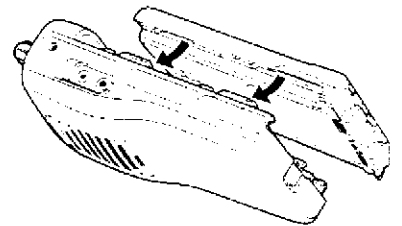

2 Slide the battery pack along the back of the transceiver until the release latch on the base of the transceiver locks.

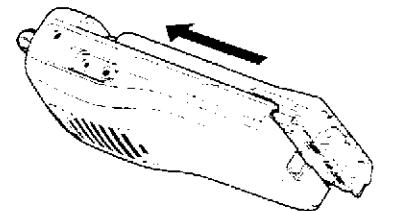

3 To remove the battery pack, pull back on the release latch and slide the pack away from the transceiver.

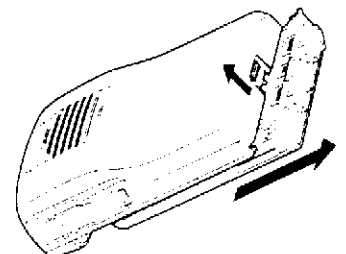

■ Installing the Antenna

Screw the antenna into the connector on the top of the transceiver by holding the antenna at its base and turning it clockwise until secure.

Note: The antenna is neither a handle, a key ring retainer, nor a speaker/microphone attachment point. Using the antenna in these ways may damage the antenna and degrade your transceiver's performance.

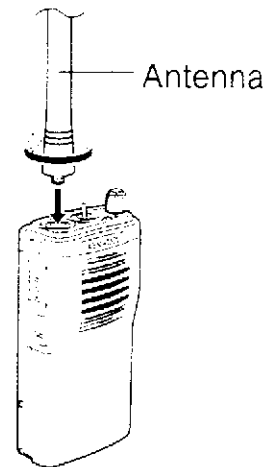

■ Installing the Belt Clip

If necessary, attach the belt clip using the two supplied 3 x 8 mm screws.

Note: If the belt clip is not installed, its mounting location may get hot during continuous transmission or when left sitting in a hot environment.

CAUTION: DO NOT USE GLUE WHICH IS DESIGNED TO PREVENT SCREW LOOSENING WHEN INSTALLING THE BELT CLIP, AS IT MAY CAUSE DAMAGE TO THE TRANSCEIVER. ACRYLIC ESTER, WHICH IS CONTAINED IN THESE GLUES, MAY CRACK THE TRANSCEIVER'S BACK PANEL.

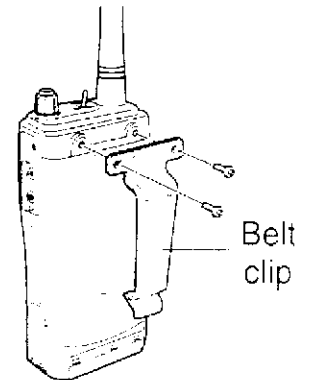

■ Installing the Cover over the Speaker/ Microphone Jacks

If you are not using a speaker/ microphone, install the cover over the speaker/ microphone jacks using the supplied 3 x 6 mm screw.

Note: To keep the transceiver water resistant, you must cover the speaker/ microphone jacks with the supplied cover.

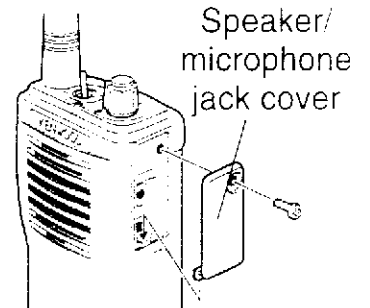

■ Installing the (Optional) Speaker/ Microphone

- 1 Insert the speaker/ microphone plugs into the speaker/ microphone jacks.
- 2 Attach the locking bracket using the supplied 3 x 6 mm screw.

Note: The transceiver is not fully water resistant while using the speaker/ microphone.

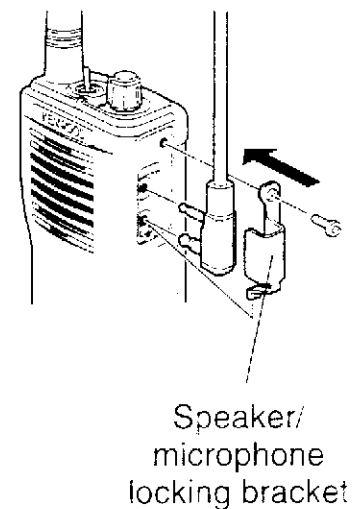

GETTING ACQUAINTED

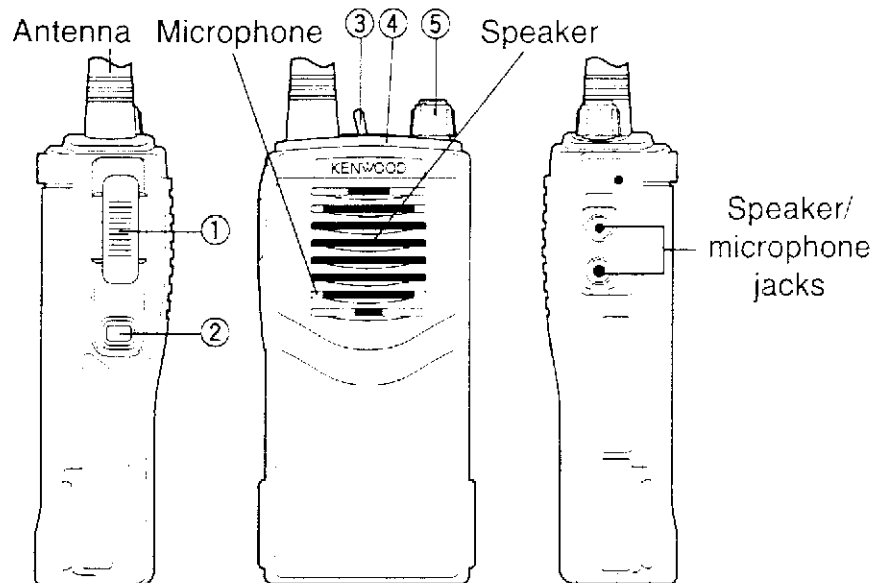

① **PTT (Push-To-Talk) switch**

Press this switch, then speak into the microphone to call a station. Release the switch to receive.

② **Monitor key**

Press and hold this key to turn the squelch OFF. You will hear background noise. Release the key to turn the squelch back ON.

③ **Channel switch (2 channel model only)**

Toggle this switch to select channel 1 or channel 2.

④ **LED indicator**

Lights red while transmitting, green while receiving a signal, and orange while in setup mode. Flashes red when the battery voltage is low while transmitting.

⑤ **Power switch/ Volume control**

Turn clockwise to switch ON the transceiver. Turn counterclockwise until a click sounds, to switch OFF the transceiver. Rotate to adjust the volume level.

OPERATING BASICS

- 1 Switch ON the transceiver by turning the **Power** switch/ **Volume** control clockwise.

- A beep sounds.

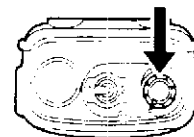

- 2 Adjust the volume by pressing and holding the **Monitor** key, then rotating the **Power** switch/ **Volume** control.

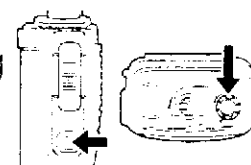

- 3 Use the **Channel** switch (2 channel model only) to choose your desired channel.

- When you receive an appropriate signal, you will hear audio from the speaker.

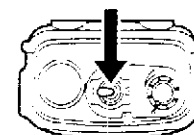

- 4 To make a call, press and hold the **PTT** switch, then speak into the microphone using your normal speaking voice.

- Hold the microphone approximately 1.5 inches (3 to 4 cm) from your lips.

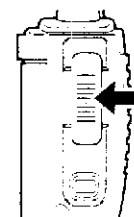

- 5 Release the **PTT** switch to receive.

Note:

- ◆ *The channel in use may have been programmed with a signalling code. Refer to "QUIET TALK (QT)" on page 11.*
- ◆ *When the battery pack voltage becomes too low, transmission will stop and the LED will blink red. Refer to "Low Battery Warning" on page 18.*
- ◆ *Channels are preprogrammed with frequencies and QT tones. Refer to "Reference Tables" on page 17.*

CHANNEL FREQUENCY SELECTION

You can change the frequency on each channel.

The transceiver will exit the setup mode if no operation is performed within 5 seconds.

- 1 Press and hold the **PTT** switch and **Monitor** key, then turn the power ON.

- Continue to hold the **PTT** switch and **Monitor** key until the LED lights orange, then release the keys.

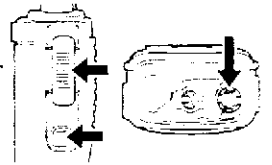

- 2 Press the **PTT** switch.

- The LED changes from orange to red and a beep sounds. The transceiver is now in frequency setup mode.

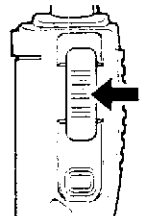

- 3 Use the **Channel** switch (2 channel model only) to choose the channel you want to set up.

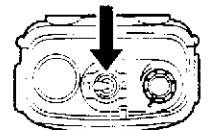

- 4 Press the **PTT** switch to change the frequency number.

- Each time you press the **PTT** switch, a beep sounds and the frequency number changes. There are a total of 4 different frequencies (1 ~ 4) for the ProTalk™ VHF and 8 different frequencies (1 ~ 8) for the ProTalk™ UHF.

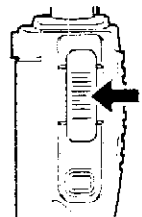

ProTalk™ VHF:

Action	Frequency			Beep pattern
	No.	Value (MHz)	Color	
Press PTT 1 time	1	151.6250	Red	•
Press PTT 2 times	2	151.9550	Purple	••
Press PTT 3 times	3	154.5700	Blue	•••
Press PTT 4 times	4	154.6000	Green	••••

*Note: Pressing the **PTT** switch more than 4 times will cause an error tone to sound, and no value will be selected.*

ProTalk™ UHF:

Action	Frequency			Beep pattern
	No.	Value (MHz)	Color	
Press PTT 1 time	1	464.5000	Brown	•
Press PTT 2 times	2	464.5500	Yellow	••
Press PTT 3 times	3	467.7625	J	•••
Press PTT 4 times	4	467.8125	K	••••
Press PTT 5 times	5	467.8500	Silver Star	•••••
Press PTT 6 times	6	467.8750	Gold Star	-•
Press PTT 7 times	7	467.9000	Red Star	-••
Press PTT 8 times	8	467.9250	Blue Star	-•••

Note:

- ◆ Pressing the **PTT** switch more than 8 times will cause an error tone to sound, and no value will be selected.
- ◆ If you are a new licensee, please do not use frequencies 3 (color: J) and 4 (color: K). If you have any questions, please call 1-888-CALL-FCC (1-888-225-5322).

- 5 Wait for 2 seconds to hear the beep pattern of the selected frequency number.

6 Press the **Monitor** key to complete the setting.

- The red LED blinks twice.

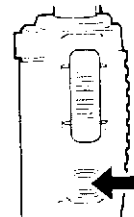

7 Press the **Monitor** key again to confirm the beep pattern of the selected frequency number.

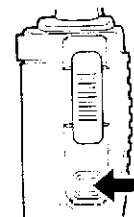

8 On the 2 channel model, repeat steps 3 to 7 to set up the other channel.

Example of setting a channel to frequency no. 3:

- 1 After entering frequency setup mode, select channel 1.
- 2 Press the **PTT** switch 3 times to select frequency 3 (ProTalk™ VHF: Blue/ ProTalk™ UHF: J).
 - A beep sounds each time you press the **PTT** switch.
- 3 Wait for 2 seconds to hear the beep pattern of the frequency number.
 - Three short beeps sound.
- 4 Press the **Monitor** key.
 - The red LED blinks twice.
- 5 Press the **Monitor** key again.
 - Three short beeps sound to confirm that frequency 3 has been selected.

QUIET TALK (QT)

QT allows you to hear only signals on your channel which are coded to match your transceiver. When a received signal has a code different from the one set up in your transceiver, squelch will not open and you will not hear the signal. When a received signal has a code that matches your code, squelch will open and you will hear the signal.

Likewise, when you transmit on a channel set up with QT, the receiving station must have a matching code in order to hear your signal.

- QT tones are selected from 38 standard signalling codes (see the table below).
- Selecting "00" will turn signalling OFF.

Code	No.	Freq. (Hz)	Code	No.	Freq. (Hz)	Code	No.	Freq. (Hz)
XZ	01	67.0	1B	14	107.2	6Z	27	167.9
XA	02	71.9	2Z	15	110.9	6A	28	173.8
WA	03	74.4	2A	16	114.8	6B	29	179.9
XB	04	77.0	2B	17	118.8	7Z	30	186.2
WB	05	79.7	3Z	18	123.0	7A	31	192.8
YZ	06	82.5	3A	19	127.3	M1	32	203.5
YA	07	85.4	3B	20	131.8	M2	33	210.7
YB	08	88.5	4Z	21	136.5	M3	34	218.1
ZZ	09	91.5	4A	22	141.3	M4	35	225.7
ZA	10	94.8	4B	23	146.2	M5	36	233.6
ZB	11	97.4	5Z	24	151.4	M6	37	241.8
1Z	12	100.0	5A	25	156.7	M7	38	250.3
1A	13	103.5	5B	26	162.2	—	00	OFF

■ QT Tone Setup

Note:

- ◆ Refer to the signalling codes listed in the table on page 11.
- ◆ When selecting a single digit number (0 ~ 9), always use 2 digits (00 ~ 09).
- ◆ When you are confirming the selected signalling number, there is a short pause between the 10's digit and the 1's digit.

The transceiver will exit the setup mode if no operation is performed within 5 seconds.

- 1 Press and hold the **PTT** switch and **Monitor** key, then turn the power ON.

- Continue to hold the **PTT** switch and **Monitor** key until the LED lights orange, then release the keys.

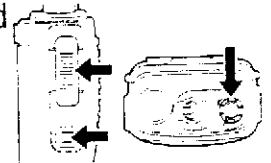

- 2 Press the **Monitor** key.

- The LED changes from orange to green and a beep sounds. The transceiver is now in QT tone setup mode.

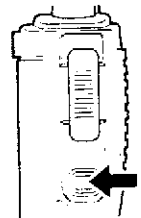

- 3 Use the **Channel** switch (2 channel model only) to choose the channel you want to set up.

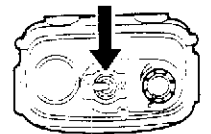

4 Press the **PTT** switch to select the 10's digit of the signalling number.

- Each time you press the **PTT** switch, a beep sounds and the 10's digit of the signalling number changes. There are a total of 4 different numbers (0 ~ 3).

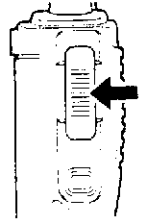

Action	Value	Beep pattern
Press and hold PTT for 2 seconds	0 x	1 second tone
Press PTT 1 time	1 x	•
Press PTT 2 times	2 x	••
Press PTT 3 times	3 x	•••

Note:

- ◆ To select "0", press and hold the **PTT** switch until a 1 second tone sounds (approximately 2 seconds).
- ◆ Pressing the **PTT** switch more than 3 times will cause an error tone to sound, and no value will be selected.

5 Wait for 2 seconds to hear the beep pattern of the 10's digit number you selected .

6 Press the **PTT** switch to select the 1's digit of the signalling number.

- Each time you press the **PTT** switch, a beep sounds and the 1's digit of the signalling number changes. There are a total of 10 different numbers (0 ~ 9).

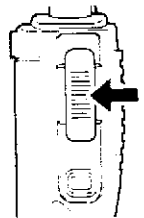

Action	Value	Beep pattern
Press and hold PTT for 2 seconds	x 0	1 second tone
Press PTT 1 time	x 1	•
Press PTT 2 times	x 2	••
Press PTT 3 times	x 3	•••
Press PTT 4 times	x 4	••••
Press PTT 5 times	x 5	•••••
Press PTT 6 times	x 6	-•
Press PTT 7 times	x 7	-••
Press PTT 8 times	x 8	-•••
Press PTT 9 times	x 9	-••••

Note:

- ◆ To select "0", press and hold the **PTT** switch until a 1 second tone sounds (approximately 2 seconds).
- ◆ Pressing the **PTT** switch more than 9 times will cause an error tone to sound, and no value will be selected. (If you set the 10's digit to "3", an error will occur after pressing the **PTT** switch more than 8 times.)

7 Wait for 2 seconds to hear the beep pattern of the 1's digit number you selected.

8 Press the **Monitor** key to complete the setting.

- The green LED blinks twice.

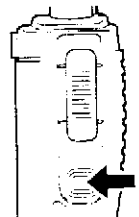

- 9 Press the **Monitor** key again to confirm the beep pattern of the selected signalling number.

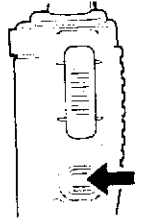

- 10 On the 2 channel model, repeat steps 3 to 9 to set up the other channel.

Example of setting up a channel with QT tone no. 01:

- 1 After entering QT setup mode, select channel 1.
- 2 Press and hold the **PTT** switch until a 1 second tone sounds, to select 0 for the 10's digit (approximately 2 seconds).
 - A 1 second tone will sound to confirm that 0 has been selected.
- 3 Wait for 2 seconds.
 - A 1 second tone will sound to confirm that 0 has been selected.
- 4 Press the **PTT** switch 1 time to select 1 for the 1's digit.
 - A beep sounds when you press the **PTT** switch.
- 5 Wait for 2 seconds.
 - A short beep will sound to confirm that 1 has been selected.
- 6 Press the **Monitor** key.
 - The green LED blinks twice.
- 7 Press the **Monitor** key again.
 - A 1 second tone will sound (0), there will be a short pause, and then a short beep will sound (1) to confirm that 01 has been selected.

CHANNEL SETTING CONFIRMATION

You can confirm the channel settings of your transceiver.

Note: After confirming a setting, you must turn the power OFF and then ON again so the transceiver can operate normally.

■ Frequency Confirmation

- 1 Select the channel you want to confirm.
- 2 Press and hold the **PTT** switch, then turn the power ON.
 - The beep pattern will sound. [i.e.- If frequency 3 (ProTalk™ VHF: Blue/ ProTalk™ UHF: J) is set up on the channel, 3 short beeps will sound.]
- 3 Turn the power OFF after confirming the number.
- 4 On the 2 channel model, repeat steps 1 to 3 to confirm the frequency of the other channel.

■ QT Tone Confirmation

Note: There is a short pause between the confirmation of the 10's digit and the confirmation of the 1's digit.

- 1 Select the channel you want to confirm.
- 2 Press and hold the **Monitor** key, then turn the power ON.
 - The beep pattern will sound. [i.e.- If QT tone 01 is set up on the channel, a 1 second tone will sound (0), there will be a short pause, and then a short beep will sound (1).]
- 3 Turn the power OFF after confirming the number.
- 4 On the 2 channel model, repeat steps 1 to 3 to confirm the QT tone of the other channel.

■ Confirmation Beep Patterns

Number	Beep pattern	Number	Beep pattern
0	1 second tone	5	•••••
1	•	6	–•
2	••	7	–••
3	•••	8	–•••
4	••••	9	–••••

■ Reference Tables

Factory Default Channel Settings:

Channel	ProTalk™ VHF	ProTalk™ UHF
1	Blue (154.5700 MHz)/ Quiet Talk: 01 (67.0 Hz)	Yellow (464.5500 MHz)/ Quiet Talk: 01 (67.0 Hz)
2	Green (154.6000 MHz)/ Quiet Talk: 01 (67.0 Hz)	Blue Star (467.9250 MHz)/ Quiet Talk: 01 (67.0 Hz)

Personal Channel Settings:

Channel number	Frequency setting	Signalling setting
1		
2		

TRANSCEIVER FUNCTIONS

■ Time-out Timer (TOT)

The purpose of the Time-out Timer is to prevent any single person from using a channel for an extended period of time.

If you continuously transmit for 3 minutes, the transceiver will stop transmitting and a tone will sound. To stop the tone, release the **PTT** switch. You can press the **PTT** switch again to resume transmitting.

■ Battery Save

The Battery Save function decreases the amount of power used when a signal is not being received and no operations are being performed (no keys are being pressed, and no switches are being turned).

While the channel is not busy and no operation is performed for 10 seconds, Battery Save is enabled. When a signal is received or an operation is performed, Battery Save is disabled.

■ Low Battery Warning

Low Battery Warning alerts you when the battery needs to be recharged.

While transmitting, if the battery power goes below a pre-determined value, the LED will blink red. When a tone sounds, the transceiver stops transmitting. Replace or recharge the battery pack.

CHARGING THE NiCd BATTERY PACK

Initially charging the battery pack after purchase or extended storage (greater than 2 months) will not bring the battery pack to its normal operating capacity. After repeating the charge/discharge cycle two or three times, the operating capacity will increase to normal.

CAUTION:

- ◆ *DO NOT RECHARGE THE BATTERY PACK IF IT IS ALREADY FULLY CHARGED. DOING SO MAY CAUSE THE LIFE OF THE BATTERY PACK TO SHORTEN OR THE BATTERY PACK MAY BE DAMAGED.*
- ◆ *AFTER RECHARGING THE BATTERY PACK, DISCONNECT IT FROM THE CHARGER. CHARGING THE BATTERY PACK FOR MORE THAN 5 DAYS MAY REDUCE THE BATTERY PACK LIFE DUE TO OVERCHARGING.*

Note:

- ◆ *The ambient temperature should be between 41 and 104°F (5 and 40°C) while charging is in progress. Charging outside this range may not fully charge the battery.*
- ◆ *Always switch OFF the transceiver equipped with a NiCd battery pack before charging. Using the transceiver while charging its battery pack will interfere with correct charging.*
- ◆ *The battery pack life is over when its operating time decreases even though it is fully and correctly charged. Replace the battery pack.*

1 Plug the AC adaptor cable into the adaptor jack located on the rear of the charger.

2 Plug the AC adaptor into an AC outlet.

3 Slide the NiCd battery pack or the transceiver equipped with a NiCd battery pack into the charging slot.

- Make sure the metal contacts on the battery pack come in contact with the charging terminals.
- The charger LED lights and charging begins.

4 After charging the supplied KNB-14 battery pack for 8 hours, remove it or the transceiver from the charger.

- The charger does not turn OFF automatically after charging is completed.

5 Unplug the AC adaptor from the AC outlet.

Note: It takes approximately 15 hours to fully charge the optional KNB-15A battery pack.

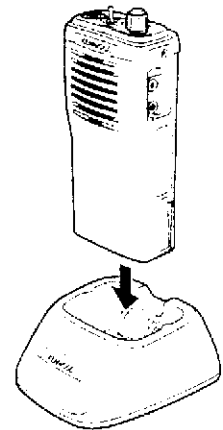
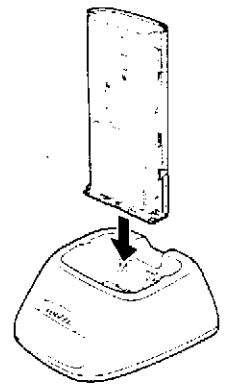
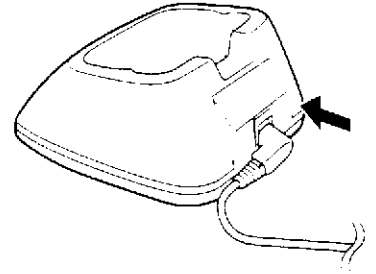

OPTIONAL ACCESSORIES

You can use the following accessories with your transceiver:

- KNB-14: Standard Battery (7.2 V/ 600 mAh)
- KNB-15A: Long Life Battery (7.2 V/ 1100 mAh)
- KSC-15: Regular Battery Charger
- KSC-16: Rapid Battery Charger
- KSC-21R: Refreshable Rapid Battery Charger
- KHS-1: Head Set with VOX (Voice Operated Transmit)
- KMC-17: Speaker/ Microphone (Standard Duty)
- KMC-21: Speaker/ Microphone (Light Duty)
- KBP-1: Alkaline Battery Case
- KBH-8: Spring-action Belt Clip
- KWR-1: Water Resistant Bag

TROUBLESHOOTING GUIDE

Problem	Solution
No power.	<ul style="list-style-type: none"> • The battery pack may be dead. Recharge or replace the battery pack. • The battery pack may not be installed correctly. Remove the battery pack and install it again.
Battery power dies shortly after charging.	The battery pack life is finished. Replace the battery pack with a new one.
Cannot talk to or hear other members in your group.	<ul style="list-style-type: none"> • Make sure you are using the same frequency and Quiet Talk tone as the other members in your group. • Other group members may be too far away. Make sure you are within range of the other transceivers.
Other voices (besides group members) are present on the channel.	Change the Quiet Talk tone. Be sure to change the tone on all transceivers in your group.

Free Manuals Download Website

<http://myh66.com>

<http://usermanuals.us>

<http://www.somanuals.com>

<http://www.4manuals.cc>

<http://www.manual-lib.com>

<http://www.404manual.com>

<http://www.luxmanual.com>

<http://aubethermostatmanual.com>

Golf course search by state

<http://golfingnear.com>

Email search by domain

<http://emailbydomain.com>

Auto manuals search

<http://auto.somanuals.com>

TV manuals search

<http://tv.somanuals.com>