

KENWOOD

sovereign
User's Guide

How to Use And Enjoy Your
LCD Remote Control

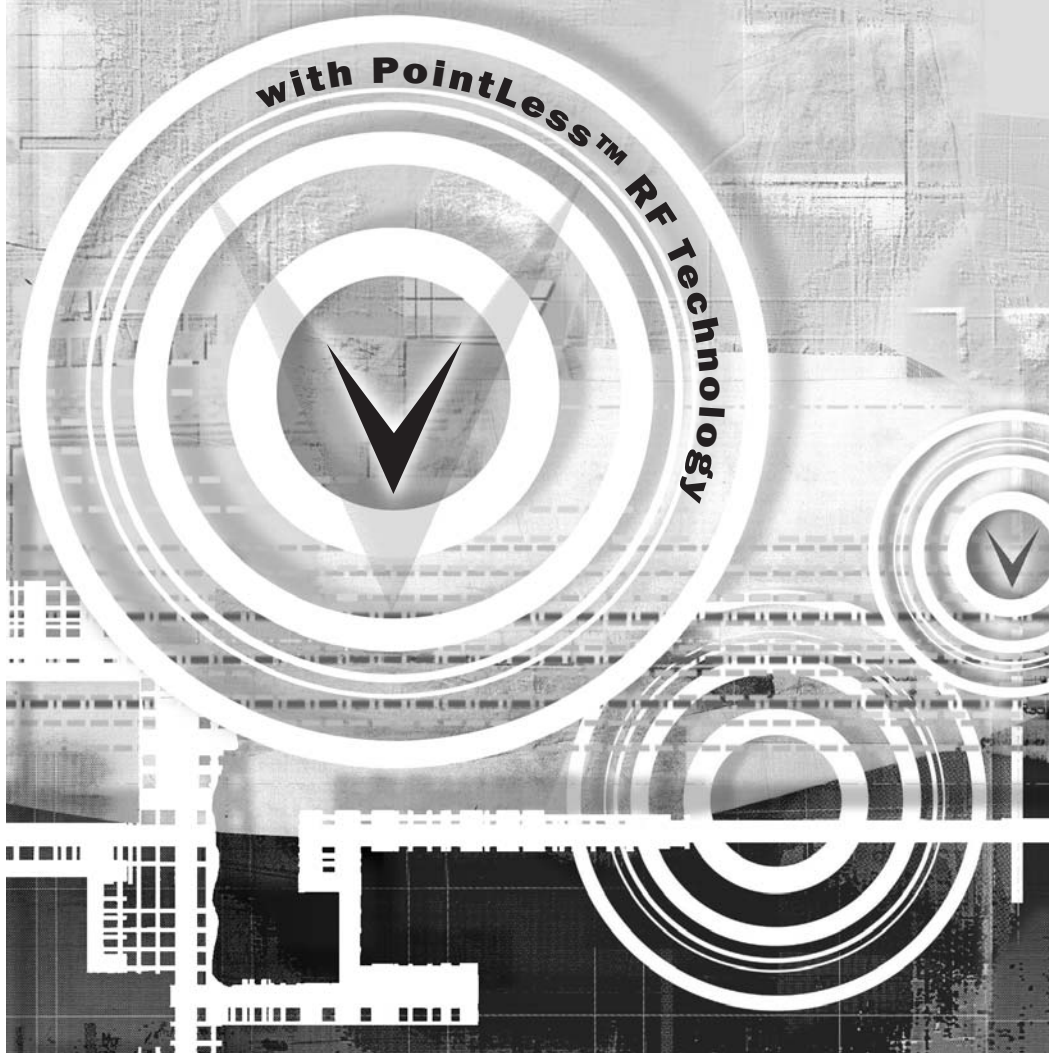

Setting Up Your LCD Remote Controller

Your new LCD Remote is a powerful controller that you can easily set up to remotely control a Kenwood receiver as well as all of the IR-controllable audio and video components in your entertainment system. The remote's macro capabilities make it easy for you to perform complex operations by touching a single button.

Before you can use your remote to control any of your system's components you first must program it. Programming the remote to control components will be described later in this chapter.

Installing the Batteries

Before you can set up any remote control unit item, you need to install batteries.

- The batteries that came with your new remote control unit are intended for an operation check—they may not last as long as alkaline batteries. We recommend replacing them with batteries for normal use.

To install the batteries:

1. Slide down the battery cover as shown by the figure to remove it.
2. Insert four AA(R6) batteries with the correct polarity. Then close the battery cover.

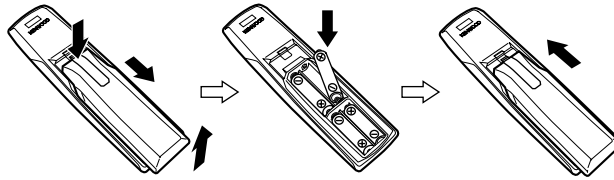

When the remote control range reduces or the Low Battery indicator () flashes on the LCD screen, replace all of the four batteries at the same time as described above.

Resetting the Remote



The Remote Control unit can be reset in two ways

To reset the remote without clearing the setups:

- Remove the batteries then reload them again.

This resets the Remote Control unit but the speaker setup and device setup remain unchanged.

To reset everything and initialize the remote to the factory condition:

1. Remove the batteries.
2. While holding the  (function up) button and  button simultaneously, load the batteries.

This operation resets all of the setups made by you.

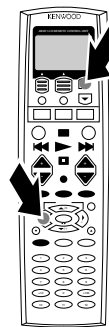

Changing the RF Transmission Frequency

The RF remote function may be affected by radio interference, etc. If this happens, you can change the RF transmission frequency.

To change the RF remote transmission frequency:

1. Open the battery cover on the rear.
2. Change the RF switch setting.

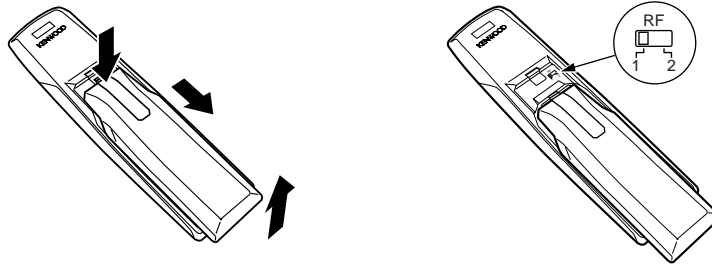

After changing remote control's RF frequency, you also must change the receiver's RF reception frequency.

3. To change the receiver's RF reception frequency.

- Press and hold the RF BAND button (TAPE2/CD2 /MONITOR button) behind the receiver's front panel door for more than 2 seconds. Each time you do this, the RF reception frequency switches between RF Band 1 and RF Band 2. Select the same band as the position number of the remote's RF switch.

Remote Controllable Range

Your LCD remote transmits RF signals to the receiver, and the receiver sends IR signals back to the remote.

The remote's range is about 20 ft provided there are no obstacles (see illustration to right).

The remote transmits an infrared signal in addition to an RF signal. When RF operation is not possible because of radio wave conditions, you can aim the remote towards the receiver and use it as a conventional infrared remote control.

Since the LCD remote uses infrared signals to control other A/V components and devices, aim it towards the respective unit.

The following factors can maximize the performance of your LCD remote:

1. Position the receiver's RF antenna to achieve maximum RF range.
2. Do not position the receiver near metal (such as heat ducts). Metal can absorb RF signals.

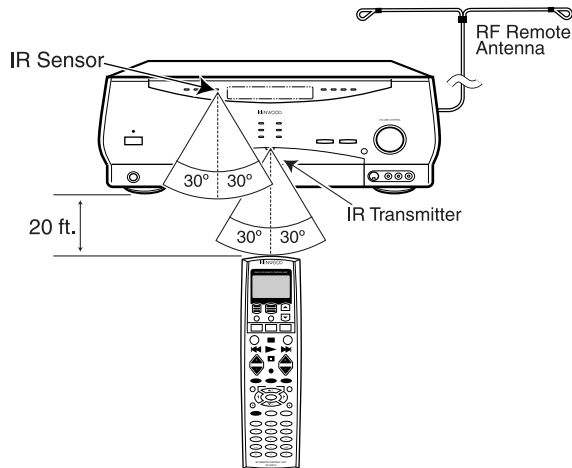

- Do not install the receiver where direct sunlight or high-frequency fluorescent lighting can shine directly into the infrared remote sensor. This can limit the remote's operating range.
- Make sure that the remote's range is not being affected by other radio frequency transmissions.
- Do not block the IR transmitter on the remote or on the receiver's front panel. Even a brief blockage of the transmission (such as someone walking by) can cause the communication and feedback to become temporarily erratic. If this happens, press the CONFIRM/SHIFT button on the remote and it will resume normal operation (you might need to reenter the interrupted command).
- When the remote's operating range gets shorter or the low battery indicator () flashes on its LCD display, replace all 4 batteries:

Programming the LCD Remote to Control Other Components

Your LCD remote can be programmed to control almost any IR-controllable audio-video source component and television. If the component's code is not already part of the remote's extensive library, you can use the remote's Learn feature to teach the component's commands to it. You can also use the Learn function to expand the control capabilities of components with existing codes.

- Press the MUSIC or MOVIE button.
The display will show:

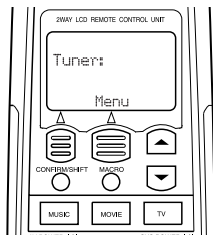

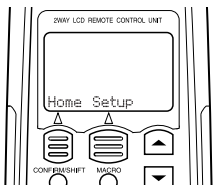

- Press 'Menu'. The display will show:



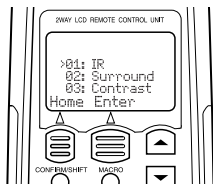

- Press 'Setup'. The display will show:



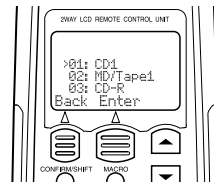

- Use the  and  buttons to select "01: IR", and press 'Enter'. The display will show a list of the receiver's input jack sets:

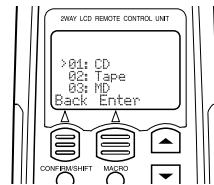

- Use the  and  buttons to select one of the receiver's jack sets that has a component connected to it, and press 'Enter'. The display will show a list of component types:



- Use the  and  buttons to select the type of component connected to that jack set, then press 'Enter'. The display will show a list of brands:

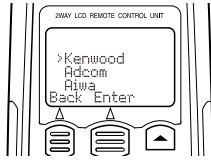

7. Use the and buttons to select the component's brand, then press 'Enter'.
 - If the manufacturer of your component is not listed, select 'Nothing' and press 'Enter'. You can program the component's functions using the remote's Learning capability (see below).

The display will show a list of control codes for your component:



8. Select the first control code on the list.
 - If the component is a Kenwood component connected to the receiver via a System Control cable, select 'System'. The remote will send all commands for the component to the receiver, which will control the component via the System Control cable.
9. Press the remote's AV POWER button.

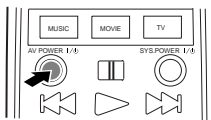

The remote will send a "power" test signal to the component. If the component turns on, the code you selected was correct. If it does not turn on, try the next code on the list. Continue until one of the codes works. If none of the codes work, you can program the component's functions using the remote's Learning capability.

- If you entered 'System' in step 8, skip this step.
10. When you have finished step 9 the remote's LCD display reverts to step 4. Repeat steps 4 through 9 for each component you want the LCD Remote to control.

Changing a Setup Code

If you replace an existing component with a new one you will need to perform steps 1 - 10 to program the remote to control the new component.

Deleting a Setup Code

If you disconnect a component from the system and do not replace it, you can remove its control code from the remote.

1. Repeat steps 1 - 6 above.
2. In step 6, select "No Type" or "Delete".
 - If you select "No Type", the input will still appear when you select inputs using the remote's MUSIC, MOVIE or TV buttons, but no component is associated with it.
 - If you select "Delete", the remote deletes the input, and it does not appear when you select inputs using the remote's MUSIC, MOVIE or TV buttons.

Programming a Function in a Button (Learning)

Your LCD remote can learn functions from almost any standard IR remote. The remote can learn commands to control a component that couldn't be successfully programmed in the previous section, and the remote can learn codes to extend the functions of components that were successfully programmed.

- The remote can learn new functions onto the buttons marked gray in the illustration:
- The remote can learn a different set of functions for each component that has been identified to the remote in steps 1 - 10 of the previous section). See pages 9 - 14 for the button layouts of the various types of components.



To Control a Component that Couldn't be Successfully Programmed

1. Place the LCD Remote and the remote you want to learn the commands from head-to-head, about 4 inches apart:

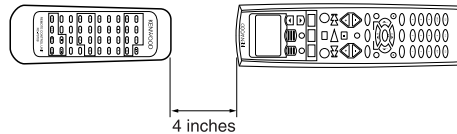

2. Press the MUSIC, MOVIE or TV button to select the component whose commands you want to learn.
3. Press the remote's LEARN button.

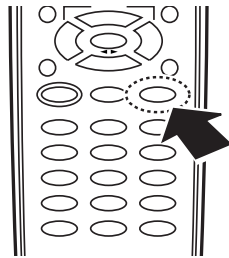

4. Press the button on the LCD remote into which you want to program the new function. The display will show:



5. Press and hold the button with the function that you want the LCD remote to learn. Do not move either remote until the LCD remote's display changes from "Waiting" to "Complete".

- To reset a button to its original factory-programmed function, press the 'Clr' button in step 3 of the above procedure.
6. Repeat steps 3 -4 to finish programming the remote to control the component.
 7. Repeat steps 1 - 4 to program the remote to control a different component.
- When you are finished, press the 'Exit' button.

To Extend the Functions of a Component that was Successfully Programmed

By using the LCD remote's "Extend 1 - 5" functions you can program up to 5 extended functions for each component you have set the remote up to control.

1. Place the LCD Remote and the remote you want to learn the commands from head-to-head, about 4 inches apart:

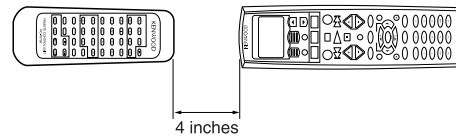

2. Press the MUSIC, MOVIE or TV button to select the component you want to add functions to.
3. Press the remote's LEARN button.

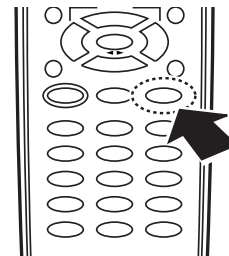

The display will show:

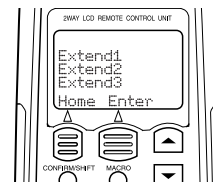

4. Use the and buttons to select 'Extend1', 'Extend2', 'Extend3', 'Extend4', or 'Extend5'; press 'Enter'. The display will show:

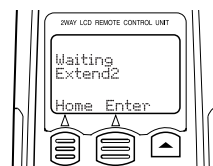

5. Press the button on the LCD remote into which you want to program the new function.
6. Press and hold the button with the function that you want the LCD remote to learn. Do not move either remote until the LCD remote's display changes from "Waiting" to "Complete".
 - To reset a button to its original factory-programmed function, press the 'Clr' button in step 3 of the above procedure.
7. Repeat steps 1 - 6 to program more extended functions for that component, or to program extended functions for another component.
 - When you are finished, press the 'Exit' button.

Using Your LCD Remote

Note: Pressing the F.SHIFT button (#25) activates a button's secondary function

1. **LCD display:** see page 9
- 2/3. **LCD function buttons 1 and 2:**
Selects the function shown directly above the button on the LCD display
4. **CONFIRM/SHIFT button:** CONFIRM: re-establishes interrupted communication with the receiver; SHIFT: lets you use the Input Selector buttons (see #17) to select a component and control it without making it the active input
5. **MACRO button:** press to create and execute macros (see page 15)
6. **AV POWER button:** turns other A/V system components on and off
7. **AV component control buttons**
8. **CH.(+/-) buttons:** changes channels for the radio and A/V system components
9. **LISTEN M./INPUT MODE button:** LISTEN M cycles through the receiver's various surround sound modes; INPUT MODE cycles through the receiver's different input types (digital, analog, etc.)
10. **SOUND/DIMMER button:** SOUND activates the receiver's sound controls; DIMMER dims the receiver's fluorescent display
11. **TITLE/GUIDE button:** Controls functions of A/V components
12. **Cursor Controls:** Controls functions of A/V components
13. **RETURN/PAGE Down button:** Controls functions of A/V components
14. **REC/REC MODE button:** REC activates recording in an A/V component; REC MODE cycles the receiver's record mode between Auto/Manual/Off
15. **Numeric buttons:** Enters numeric commands
16. **LCD display cursor up/down buttons:**
Cycles through lists of items that appear on the remote's LCD display

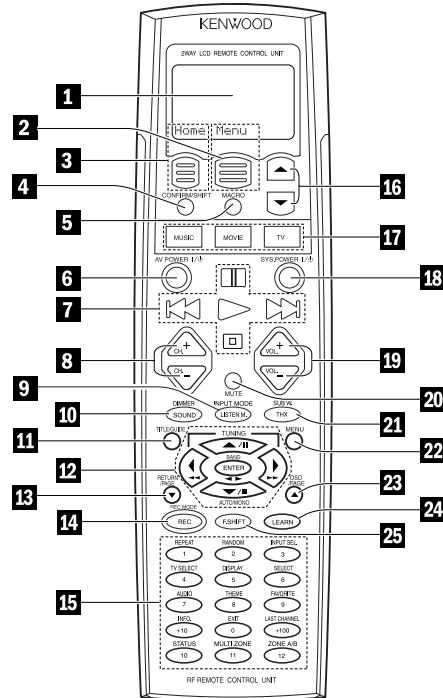

17. **Input selector buttons:** MUSIC: Selects the system's audio components; MOVIE: Selects the system's video components; TV: Controls TVs or video monitors
18. **SYS. POWER button:** Turns the receiver on and puts it into standby
19. **VOL. (+/-) buttons:** Raises and lowers the receiver's volume
20. **MUTE button:** Mutes the sound
21. **THX/SUB W. button:** THX activates the THX Cinema listening mode; SUB W. allows control of the receiver's subwoofer output volume
22. **MENU button:** Controls functions of A/V components
23. **OSD/PAGE 5 button:** Controls functions of A/V components
24. **LEARN button:** Activates the remote's learning capability (see page 5)
25. **F.SHIFT button:** Activates secondary button functions

LCD Display Indicators

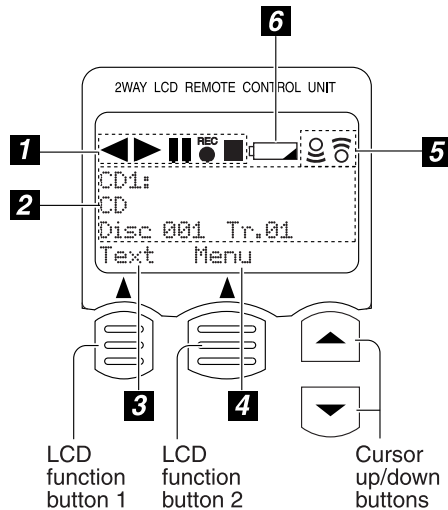

1. Playback/recording mode indicators:

◀▶ Play indicator/ || Pause indicator/
● REC Record indicator/ ■ Stop indicator

2. Character display:

Shows various information such as the source component name and track number.

3. Current function of LCD function button 1

4. Current function of LCD function button 2

5. Communication indicators:

☎ Sending / ☎ Receiving.

6. Battery indicator:

☐ appears when the batteries are nearly exhausted. When it does, replace all of the four batteries together.

Controlling Other A/V Components

In addition to controlling a Kenwood receiver, your LCD Remote can also control a variety of A/V components. Since the functions of the remote's buttons will vary depending on what component it is controlling, we suggest that you keep the following function charts handy for reference.

- The remote may not be able to control all A/V components
- Certain components may function differently from the functions shown in this manual

Cassette Deck Operation:

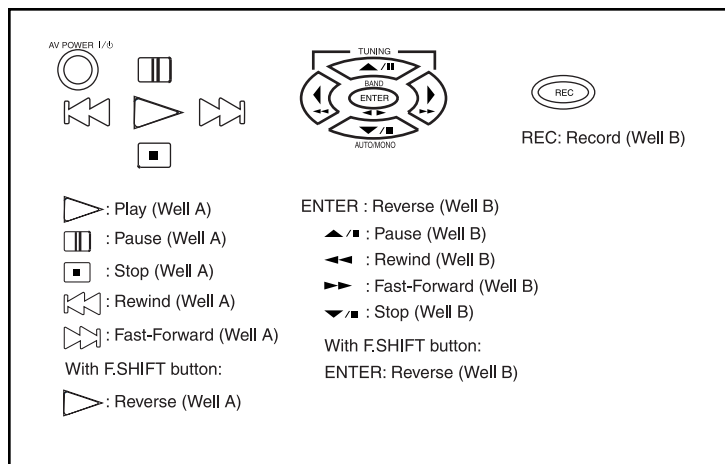

CD Player Operation:

AV POWER 1/3

TITLE GUIDE

TUNING BAND ENTER AUTOMONO

REPEAT 1 2 3
TV SELECT 4 5 6
AUDIO 7 8 9
INFO +10 0 +100
STATUS MULTI ZONE ZONE A/B 10 11 12

▶ : Play/Pause
⏸ : Pause
■ : Stop
⏮ : Skip Backward
⏭ : Skip Forward
⏪ : Disc Select (Up)
⏩ : Disc Select (Down)

⏮ : Scan Backward
⏭ : Scan Forward
○ : Track/Title

Numeric Entry

With F.SHIFT button:
REPEAT 1 : Repeat
RANDOM 2 : Random Play
DISPLAY 5 : Display

LCD Display Functions:

01: Disc Select	07: Track Title
02: Set	08: All Data Read
03: Play Mode	09: Subout Monitor
04: Check	10: Continuous Play
05: Clear	11: All Info
06: Disc Title	

CD-R Recorder Operation:

AV POWER 1/3

TUNING BAND ENTER AUTOMONO

REPEAT 1 2 3
TV SELECT 4 5 6
AUDIO 7 8 9
INFO +10 0 +100
STATUS MULTI ZONE ZONE A/B 10 11 12

▶ : Play
⏸ : Pause
■ : Stop
⏮ : Skip Backward
⏭ : Skip Forward
⏪ : Scan Forward
⏩ : Scan Backward

ENTER : Enter
▲ : Cursor Up
▼ : Cursor Down
◀ : Cursor Left
▶ : Cursor Right
REC : Record

Numeric Entry

With F.SHIFT button:
REPEAT 1 : Repeat
RANDOM 2 : Shuffle/Random Play
DISPLAY 5 : Display

LCD Display Functions:

01: Open/Close	06: Clear
02: CDR Mode	
03: CD Mode	
04: Program	
05: Record Mute	

MD Player Operation:

AV POWER 1/3

TITLEGUIDE

TUNING BAND / II

ENTER

AUTOMONO

REPEAT 1

RANDOM 2

INPUT SEL 3

TV SELECT 4

DISPLAY 5

SELECT 6

AUDIO 7

THEME 8

FAVORITE 9

INFO 10

EXIT 0

LAST CHANNEL +100

STATUS 10

MULTI ZONE 11

ZONE A/B 12

Play

Pause

Stop

Skip Backward

Skip Forward

Scan Backward

Scan Forward

Track/Title

Record

Numeric Entry

With F.SHIFT button:

REPEAT 1 : Repeat

RANDOM 2 : Random Play

DISPLAY 5 : Time

DVD Player Operation:

AV POWER 1/3

TITLEGUIDE

TUNING BAND / II

ENTER

AUTOMONO

REPEAT 1

RANDOM 2

INPUT SEL 3

TV SELECT 4

DISPLAY 5

SELECT 6

AUDIO 7

THEME 8

FAVORITE 9

INFO 10

EXIT 0

LAST CHANNEL +100

STATUS 10

MULTI ZONE 11

ZONE A/B 12

Play

Pause

Stop

Skip Backward

Skip Forward

Scan Forward

Scan Backward

ENTER : Enter

Cursor Up

Cursor Down

Cursor Left

Cursor Right

MENU

Menu

TITLEGUIDE

Title

OSD / PAGE

On-Screen Display

RETURN / PAGE

Return

With F.SHIFT button:

REPEAT 1 : Repeat

RANDOM 2 : Random Play

DISPLAY 5 : Display

AUDIO 7 : Audio

With F.SHIFT button:

Slow Reverse

Slow Forward

LCD Display Functions:

01: Disc Select	07: Clear	13: All Data Read
02: Chapter/Time	08: Repeat A - B	14: Aspect
03: Angle	09: Subtitles	15: On/Off
04: Program	10: Title Search	
05: DVD Setup	11: Disc Title	
06: Memory	12: Track Title	

VCR Operation:

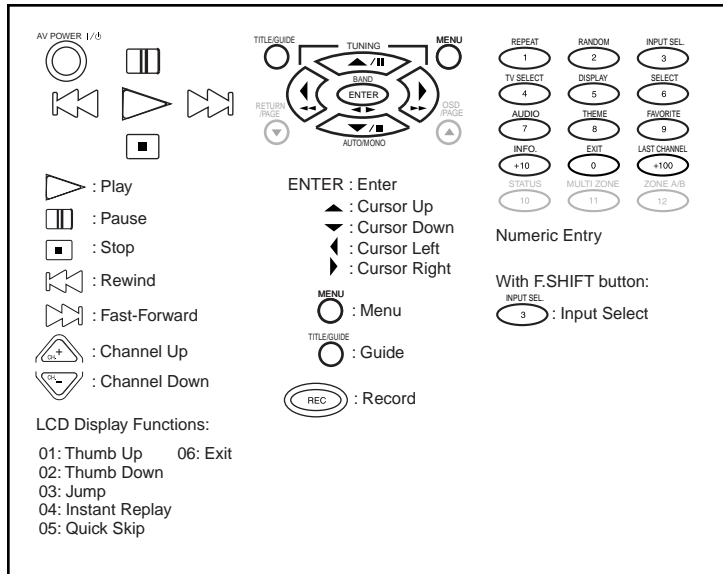

Laser Disc Player Operation:

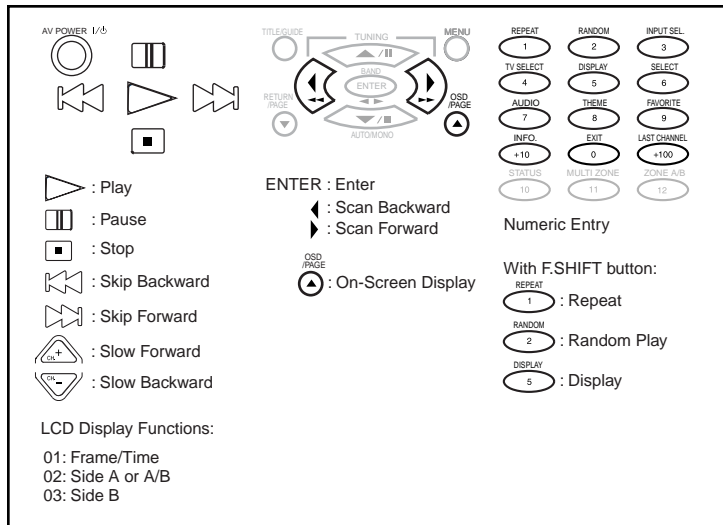

TV Operation:

AV POWER I/O

TUNING BAND ENTER AUTO MONO

REPEAT 1, RANDOM 2, INPUT SEL 3
 TV SELECT 4, DISPLAY 5, SELECT 6
 AUDIO 7, THEME 8, FAVORITE 9
 INFO, EXIT, LAST CHANNEL
 +10, 0, +100
 STATUS, MULTI ZONE, ZONE A/B
 10, 11, 12

ENTER : Enter
 ▲ : Cursor Up
 ▼ : Cursor Down
 ◀ : Cursor Left
 ▶ : Cursor Right

Mute
 Volume Down
 Volume Up
 Channel Up
 Channel Down

LCD Display Functions:
 01: - / - -
 02: >12
 03: Wide
 04: Picture-In-Picture
 05: Text/Mix/TV
 06: Text Off
 07: Mix
 08: Exit
 09 - 13: Extend 1 - 5

Numeric Entry
 With F.SHIFT button:
 INPUT SEL 3 : Video Select
 TV SELECT 4 : TV Select
 AUDIO 7 : Audio

Cable Tuner Operation:

AV POWER I/O

TITLEGUIDE TUNING BAND ENTER AUTO MONO MENU

RETURN PAGE OSD PAGE

REPEAT 1, RANDOM 2, INPUT SEL 3
 TV SELECT 4, DISPLAY 5, SELECT 6
 AUDIO 7, THEME 8, FAVORITE 9
 INFO, EXIT, LAST CHANNEL
 +10, 0, +100
 STATUS, MULTI ZONE, ZONE A/B
 10, 11, 12

ENTER : Enter
 ▲ : Cursor Up
 ▼ : Cursor Down
 ◀ : Cursor Left
 ▶ : Cursor Right

MENU : Menu
 TITLEGUIDE : Guide
 OSD PAGE : Page Up
 RETURN PAGE : Page Down

Volume Down
 Volume Up
 Channel Up
 Channel Down

LCD Display Functions:
 01: A
 02: B
 03: C
 04 - 08: Extend 1 - 5

Numeric Entry
 With F.SHIFT button:
 EXIT 0 : Exit
 INPUT SEL 3 : Input Select
 DISPLAY 5 : On-Screen Display
 SELECT 6 : Select
 THEME 8 : Theme
 FAVORITE 9 : Favorite
 INFO +10 : Info
 LAST CHANNEL +100 : Last Channel

Satellite Receiver Operation:

AV POWER 1/5

RETURN/PAGE

TITLEGUIDE

TUNING

MENU

REPEAT

RANDOM

INPUT SEL

TV SELECT

DISPLAY

SELECT

AUDIO

THEME

FAVORITE

INFO

EXIT

LAST CHANNEL

+10

0

+100

STATUS

MULTI ZONE

ZONE A/B

BAND

ENTER

AUTOMONO

OSD/PAGE

OSD/PAGE

ENTER : Enter

▲ : Cursor Up

▼ : Cursor Down

◀ : Cursor Left

▶ : Cursor Right

OSD/PAGE : On-Screen Display

Channel Up

Channel Down

LCD Display Functions:

01 - 05: Extend 1 - 5

Numeric Entry

With F.SHIFT button:

INPUT SEL : Input Select

SELECT : Select

AUDIO : Alternate Audio

DSS Receiver Operation:

AV POWER 1/5

RETURN/PAGE

TITLEGUIDE

TUNING

MENU

REPEAT

RANDOM

INPUT SEL

TV SELECT

DISPLAY

SELECT

AUDIO

THEME

FAVORITE

INFO

EXIT

LAST CHANNEL

+10

0

+100

STATUS

MULTI ZONE

ZONE A/B

BAND

ENTER

AUTOMONO

OSD/PAGE

OSD/PAGE

ENTER : Enter

▲ : Cursor Up

▼ : Cursor Down

◀ : Cursor Left

▶ : Cursor Right

MENU : Menu

TITLEGUIDE : Channel Guide

Channel Up

Channel Down

LCD Display Functions:

01: Exit

02 - 06: Extend 1 - 5

Numeric Entry

With F.SHIFT button:

INPUT SEL : Input Select

SELECT : Select

AUDIO : Alternate Audio

THEME : Theme

FAVORITE : Favorite

INFO : Info

Performing Several Actions at Once (Macros)

Your LCD Remote allows you to perform up to 20 different actions by pressing a single button. For example, you can create a macro that turns the TV on, turns the VCR on, selects the correct TV channel or input, and starts the VCR playing. The remote can store 3 different macros.

Creating a Macro

1. Think about the sequence of events you want to set up. You may even want to write down which actions you want the macro to take and what buttons you need to press (and in what order) to perform them.

2. Press and hold the MACRO button for more than 2 seconds.

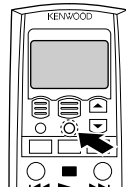

The display will show:

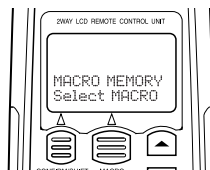

3. Within 8 seconds, press the MUSIC (Macro1), MOVIE (Macro2) or TV (Macro3) button. The display will read "MACRO 1", "MACRO 2" or "MACRO 3".
4. Press the control buttons for the functions you want the macro to perform in the order you want them to happen. Press each button slowly and firmly. Each macro can contain a maximum of 20 different steps.
5. Press the MACRO button to register the macro.
- Since most components take a few seconds after power-up before they will perform another function, we recommend programming all of a macro's power-up commands so they happen sequentially, then program the other functions of the first component that powered up, then the second, etc.
 - If a macro function is not performed properly, insert some delay time by programming the function twice.

The display will read "Full" when you have registered 20 steps for a particular macro.

To Use a Macro

1. Press the MACRO button.
 2. Within 3 seconds, press the button to which you have programmed the macro (MUSIC, MOVIE or TV).
- Continually aim the remote at the components until the macro has completed executing. (The remote's display will return to the previous screen.)

KENWOOD

Internet

www.kenwoodusa.com

e-mail:

inquiry@kenwoodusa.com

1-800-KENWOOD

Main Office:

P.O. Box 22745

Long Beach, CA 90801-5745

Canada Office:

6070 Kestrel Rd.

Mississauga, Ontario L5T 1S8

©2002 Kenwood USA Corporation. All Rights Reserved

Free Manuals Download Website

<http://myh66.com>

<http://usermanuals.us>

<http://www.somanuals.com>

<http://www.4manuals.cc>

<http://www.manual-lib.com>

<http://www.404manual.com>

<http://www.luxmanual.com>

<http://aubethermostatmanual.com>

Golf course search by state

<http://golfingnear.com>

Email search by domain

<http://emailbydomain.com>

Auto manuals search

<http://auto.somanuals.com>

TV manuals search

<http://tv.somanuals.com>