

 **KENWOOD**

TS-430S

HF TRANSCEIVER

KW-SENDEEMPFÄNGER

EMETTEUR-RECEPTEUR COMBINE HF

TRANSCEPTOR HF

RICETRASMITTORE HF

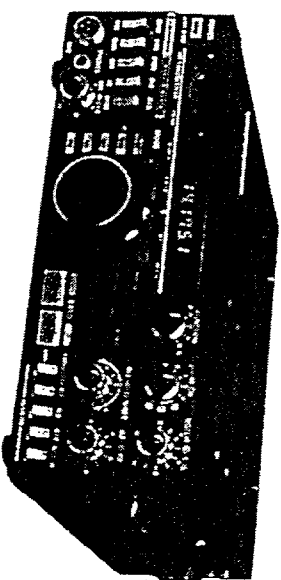

INSTRUCTION MANUAL

BEDIENUNGSANLEITUNG

MODE D'EMPLOI

MANUAL DE INSTRUCCIONES

MANUALE D'ISTRUZIONE

● SPECIFICATIONS ● TECHNISCHE DA'EN
● CARACTERISTIQUES TECHNIQUES ● ESPECIFICACIONES ● DATI TECNICI

(GENERAL)

Transmitter Frequency Range:
160, 80, 40, 30, 20, 17*, 15, 12*,

10 meter Amateur bands

Receiver Frequency Range:
150 kHz to 30 MHz

Mode: 1st IF - 48,055 MHz
AC/LSB, USB, A1 (CW), A3 (AM),

FS (FM),

Antenna Impedance:
50Ω

Power Requirement:
12.0 to 16.0 VDC (13.8 V nominal)

Power Consumption:
20A approx. in transmit mode

1-2A approx. in receive mode

Dimensions:
ZPD (10.61W x 9.6 (3.91H) x 2.75

(10.81D mm (inch))

Weight: 6.5 kg (14.3 lbs.)

4.4 kg (9.7 lbs.)

(TRANSMITTER)

Final Power Input:
160m - 1.5m band

SSB: 250WPEP

CW: 200WDC

FM: 120W

AM: 60W

10m band

SSB: 250WPEP

CW: 200WDC

FM: 120W

AM: 60W

Modulation:
SSB - Balanced Modulation

FM - Variable Reactance Direct

Shift (with FM-430 optional

accessory)

AM - Low-Level Modulation (IF

stage)

Carrier Suppression:
Better than 40 dB

Unwanted Sideband Suppression:
Better than 50 dB

Harmonic Content:
Less than -40 dB

Maximum Frequency Division

(FM): 15.6 kHz (with FM-430 optional

accessory) 10.4 kHz (with

accessory) 500.0 to 50.0 kHz

(RECEIVER)

Circuitry:
SSB, CW, AM - Double conversion

Superheterodyne

FM - Triple Conversion

Superheterodyne

Intermediate Frequency:
1st IF - 48,055 MHz

2nd IF - 8.83 MHz

3rd IF - 455 kHz (FM only)

Sensitivity:
Frequency: 150 kHz - 500 kHz

SSB/CW (10 dB S/N): Less than

1 μV

AM (10 dB S/N): Less than 13 μV

FM (30 dB S/N): -

FM (12 dB SINAD) -

Frequency: 500 kHz - 1.8 MHz

SSB/CW (10 dB S/N): Less than

4 μV

AM (10 dB S/N): Less than 40 μV

FM (30 dB S/N): -

FM (12 dB SINAD): -

Frequency: 1.8 MHz - 30MHz

SSB/CW (10 dB S/N): Less than

0.25 μV

AM (10 dB S/N): Less than 2.5 μV

FM (30 dB S/N): *Less than 1 μV

FM (12 dB SINAD): *Less than

0.7 μV

* with FM-430 optional accessory

Image Ratio:
More than 70 dB (1.8 to 30 MHz)

More than 50 dB (FM, 3rd image

ratio)

IF Rejection:
More than 70 dB (1.8 to 30 MHz)

Selectivity:
Selectivity: -6 dB

SSB/CW: 2.4 kHz

AM *1: 6 kHz

FM *2: 15 kHz

Selectivity: -60 dB

SSB/CW: 4.4 kHz

AM *1: 12 kHz

FM *2: 32 kHz

*1 with YK-88A optional filter

*2 with FM-430 optional accessory

Frequency Stability:
Better than ±30 × 10⁻⁶ (0°C to

+50°C) Within ±200 Hz from 1 to

60 minutes after turn-on, within

±30 Hz any 30 minute period

thereafter

Frequency Accuracy:
Better than 10 × 10⁻⁶

BIT Variable Range:
More than ±1 kHz

Audio Output Impedance:
4Ω to 16Ω

Audio Output Power:
More than 1.5W across 8Ω (at 10%
distortion)

* Will transmit on the new 17 and 12

meter bands, Lockout factory

installed to prevent accidental

transmission. (Note for U.S.A. only)

Note: Circuit and ratings subject to

change without notice due to

developments in technology

(ALLGEMEINES)

Sender-Abstimmbereich:
160, 80, 40, 30, 20, 17*, 15, 12*,

10m Amateur-KW-Bänder

Empfänger-Abstimmbereich:
150 kHz - 30 MHz, durchgehender

Kontrollempfänger

Betriebsarten:
J3E (USB/LSB), A1A (CW), A3E

(AM), F3E (FM) mit Modul FM-430

Antennenimpedanz:
50 Ohm

Betriebsspannung:
12.0 - 16.0V - (Nennspannung

13.8V -)

Stromverbrauch:
20A bei Senderbetrieb

1.2A bei Empfängerbetrieb

Abmessungen (B x H x T):
270 x 105 x 340 mm

Gewicht:
6.5 kg

(EMPFANGSTEIL)

Schaltungsart
J3E, A1A, A3E - Doppelsuper

F3E - Dreiflachsper

(nur mit Modul FM-430)

Zwischenfrequenzen:
1. ZI - 48,055 MHz

2. ZI - 8.83 MHz

3. ZI - 455 kHz (nur mit Modul

FM-430)

Eingangsempfindlichkeit:
Frequenz: 150 - 500 kHz

J3E/A1A (10 dB S/N): < 1 μV

A3E (10 dB S/N): < 13 μV

F3E (30 dB S/N): -

F3E (12 dB SINAD): -

Frequenz: 500 kHz - 1.8 MHz

J3E/A1A (10 dB S/N): < 4 μV

A3E (10 dB S/N): < 40 μV

F3E (30 dB S/N): -

F3E (12 dB SINAD): -

Frequenz: 1.8 - 30 MHz

J3E/A1A (10 dB S/N): < 0.25 μV

A3E (10 dB S/N): < 2.5 μV

F3E (30 dB S/N): < 1 μV*

F3E (12 dB SINAD): < 0.4 μV*

*1 mit F3E-Modul FM-430

Spiegelreflexionsunterdrückung:
70 dB (1.8 - 30 MHz)

50 dB (F3E, 3. ZI-Stufe)

ZI-Unterdrückung
70 dB (1.8 - 30 MHz)

Trennschärfe
Betriebsart: -6 dB Bandbreite

J3E/A1A: 2.4 kHz

A3E *1: 6 kHz

F3E *2: 15 kHz

Betriebsart: -60 dB Bandbreite

J3E/A1A: 4.4 kHz

A3E *1: 12 kHz

F3E *2: 32 kHz

*1) mit Zusatz-Quarzfilter YK-88A.

*2) mit F3E-Modul FM-430

Frequenzstabilität:
> ±30 × 10⁻⁶ (0°C bis +50°C),

±200 Hz innerhalb der ersten

Betriebsstunde nach dem Einschalt-

ten, danach ±30 Hz nach jeweils

weiteren 30 Minuten im betriebs-

warmen Zustand.

Frequenzgenauigkeit:
> 10 × 10⁻⁶



3

● PREPARATION FOR USE ● BETRIEBSVORBEREITUNGEN ● MISE EN PLACE PRELIMINAIRE ● PREPARACION PARA LA UTILIZACION ● PREPARATIVI PER L'USO

INTERCONNECTION

Connect the transceiver as illustrated.

ANSCHLUSS-SCHEMA

Den Transceiver wie auf Abb. 3-1 und 3-2 gezeigt anschließen.

INTERCONNEXIONS

Connecter l'émetteur-récepteur comme cela est illustré.

INTERCONEXION

Conectar el transceptor como se muestra en las ilustraciones.

COLLEGAMENTI

Collegare l'apparecchio nel modo illustrato.

Fixed Station Connection

Anschluss des ortsfesten Betriebes
Connexions de station fixe
Conexión a modo de estación fija
Collegament per l'uso come stazione fissa

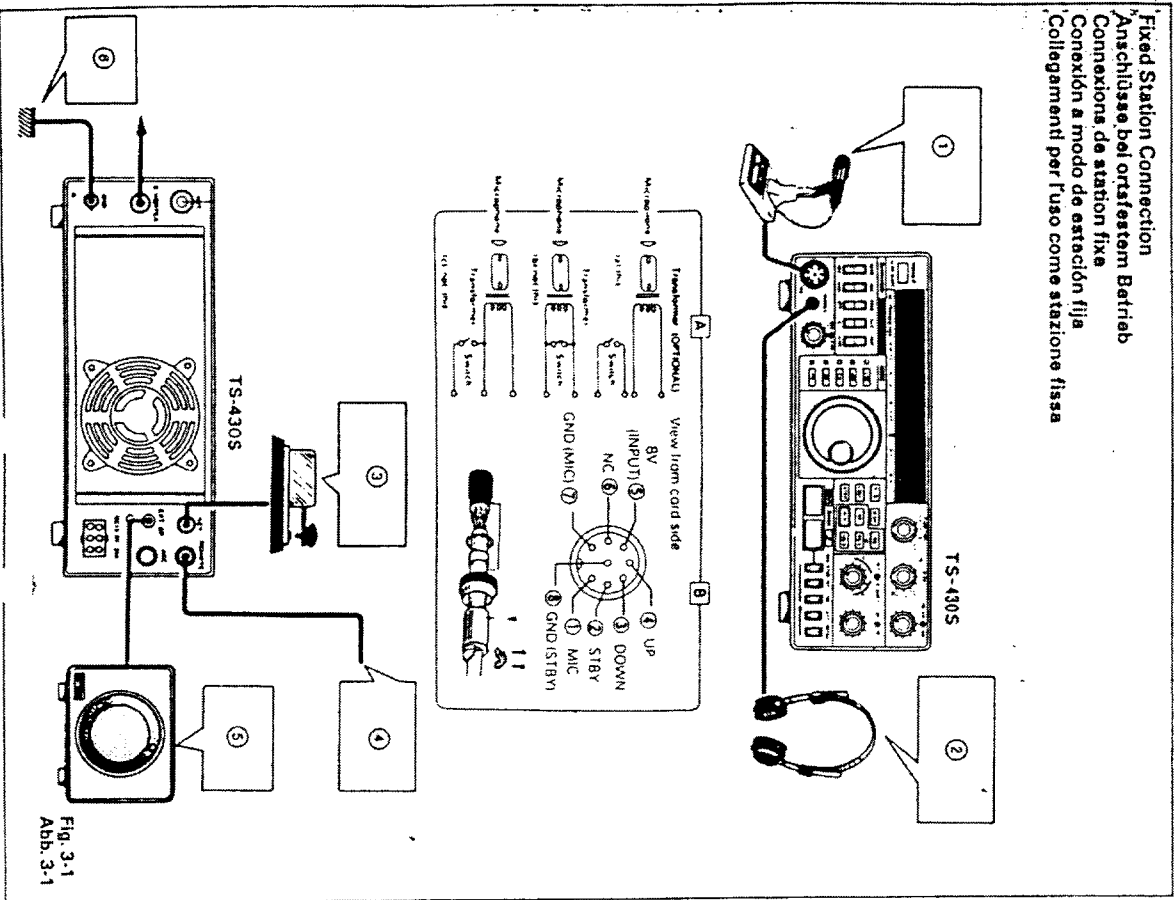

Fig. 3-1
Abh. 3-1

Antenna and Power Supply Connection for TS-430S

Antennen- und Spannungsversorgungs-Anschlüsse für TS-430S
Connexions de l'alimentation et de l'antenne du TS-430S
Conexión de la antena y fuente de alimentación para el TS-430S
Collegament de l'antenna e per l'alimentazione del TS-430S

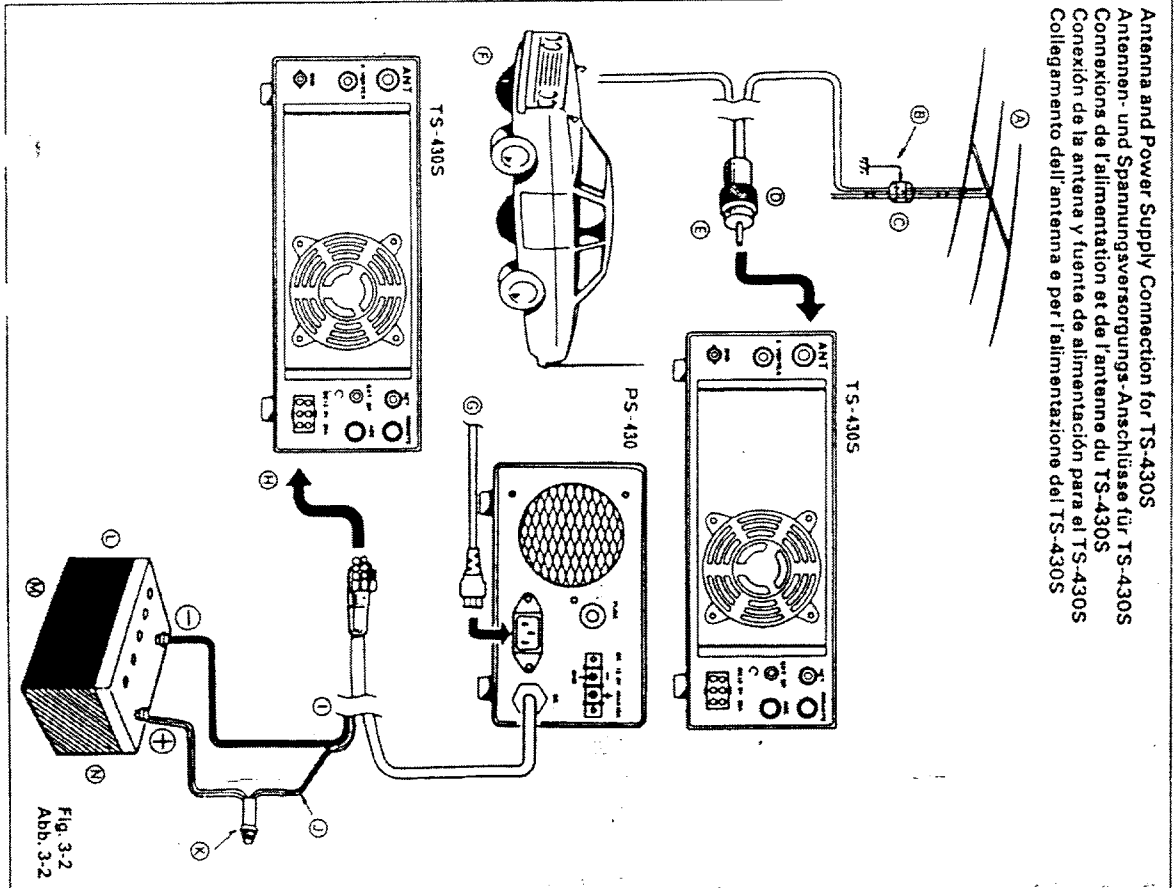

Fig. 3-2
Abh. 3-2

- ① **Microphone**
Either a low or high impedance microphone (500Ω to 50 kΩ) can be used. The PTT switch should be isolated from the mic circuit (shown in [A]). Use a microphone with a separate switch and MIC line so both PTT and VOX are available.
- ② **Headphones**
Use headphones of 4 to 16Ω impedance. The optional HS-5 or HS-6 headphones are best suited for use with the TS-430S.
- ③ **Stereo-type headphones can also be used.**
- ④ **Key**
For CW operation, connect your key to the KEY jack at the rear. Use shielded cable.
- ⑤ **External connectors**
External accessories can be connected to the TS-430S through the REMOTE connector. The PTT terminal can be used for remote control of transmit/receive operation.
- ⑥ **External speaker**
Besides the built-in speaker, an external speaker can also be used. Connect to the rear EXT SP jack using the supplied plug.
- ⑦ **GND terminal**
It is recommended that a ground lead be connected to the GND terminal at the rear of the set to prevent the possibility of electric shock. TVI and BCI. Use as short and heavy a lead as possible.
- ⑧ **Fixed station operation**
- ⑨ **Lighting bracket**
- ⑩ **For fixed station antenna installation, see Page 10.**
- ⑪ **UHF type connector**
- ⑫ **Antenna socket**
- ⑬ **Mobile station operation**
- ⑭ **To AC outlet**
- ⑮ **DC power terminal**
- ⑯ **Black-Grey**
- ⑰ **Red-White**
- ⑱ **Fuse 20A**
- ⑲ **Connect battery to DC power**
- ⑳ **12V Battery**
- ㉑ **Note: Use either battery or regulated supply, but not both.**

- ① **Mikrofon**
Ein Mikrofon mit niedriger oder hoher Impedanz (500Ω bis 50 kΩ) kann verwendet werden. Der PTT-Schalter sollte von der Mikrofonleitung getrennt werden (in [A] gezeigt). Ein Mikrofon mit einem separaten Schalter und Mikrofonkabel verwenden, so dass sowohl PTT als auch VOX-Betrieb möglich ist.
- ② **Kopfhörer**
Einem Kopfhörer mit einer Impedanz von 4 bis 16Ω verwenden. Für den TS-430S sind die als Sonderzubehör erhältlichen Kopfhörer HS-5 oder HS-6 am besten geeignet.
- ③ **Stereo-Kopfhörer können auch verwendet werden.**
- ④ **Morsastele**
Für AIA-Betrieb die Morsastele an der KEY-Buchse an der Rückseite anschließen. Ein abgeschirmtes Kabel verwenden.
- ⑤ **Fernschalt-Anschluss**
Externe Geräte können über den REMOTE-Anschluss an den TS-430S angeschlossen werden. Der PTT-Kontakt kann auch für Fernbedienung des Sendes- und Empfangsbetriebs verwendet werden.
- ⑥ **Externe Lautsprecher**
Neben dem eingebauten Lautsprecher kann auch ein externer Lautsprecher verwendet werden. An die EXT SP-Buchse an der Rückseite mit dem mitgelieferten Stecker anschließen.
- ⑦ **Erdungsanschluss (GND)**
Es wird empfohlen, ein Erdungskabel an die GND-Klemme an der Rückseite anzuschließen, um elektrische Schläge, Rundfunk- und Fernsehstörungen zu vermeiden. Das Kabel so kurz und dick wie möglich halten.
- ⑧ **Ortstreiber Betrieb**
- ⑨ **Antennen-Installation bei ortstreiber Betrieb siehe Seite 10.**
- ⑩ **Blitzableiter**
- ⑪ **PL-259-Stecker**
- ⑫ **Antennenbuchse**
- ⑬ **Mobilier Betrieb**
- ⑭ **Zur Netzsteckdose**
- ⑮ **Gleichstrom-Anschluss**
- ⑯ **Schwarz-grau**
- ⑰ **Rot-Weiß**
- ⑱ **Sicherung 20A**
- ⑲ **Batterie an Gleichstrom-Anschluss anschließen.**
- ⑳ **12V-Batterie**
- ㉑ **Hinweis: Entweder Batterie- oder Netzversorgung verwenden, aber nicht beide zusammen.**

- ① **Microphone**
On peut utiliser un microphone à basse ou à haute impédance (500Ω à 50 kΩ). L'interrupteur PTT doit être isolé du circuit du micro (indiqué en [A]). Utiliser un microphone avec un interrupteur et une ligne MIC séparés de manière à pouvoir disposer du PTT et du VOX.
- ② **Casque d'écoute**
Utiliser un casque d'écoute d'une impédance de 4 à 16Ω. Les casques d'écoute en option HS-5 ou HS-6 répondent le mieux à l'utilisation du TS-430S.
- ③ **On peut également utiliser un casque d'écoute de type stéréo.**
- ④ **Touche**
Pour le fonctionnement CW, relier votre touche à la prise KEY se trouvant à l'arrière. Utiliser un câble blindé.
- ⑤ **Connecteur de commande à distance (REMOTE)**
Les accessoires externes peuvent être reliés au TS-430S grâce au connecteur REMOTE. On peut utiliser la borne PTT pour les opérations de commande à distance de transmission et de réception.
- ⑥ **Haut-parleur externe**
On peut utiliser également un haut-parleur externe en plus du haut-parleur intégré. Le relier à la prise EXT SP se trouvant à l'arrière de l'appareil en utilisant la fiche fournie.
- ⑦ **Borne de mise à la terre (GND)**
Il est conseillé de relier un conducteur de mise à la terre à la borne GND se trouvant à l'arrière de l'appareil afin de prévenir toute électrocution, TVI et BCI. Utiliser un conducteur aussi court et aussi lourd que possible.
- ⑧ **Fonctionnement de station fixe**
- ⑨ **Paratonnerre**
- ⑩ **Pour l'installation de l'antenne de station fixe se reporter à la page 10.**
- ⑪ **Connecteur de type UHF**
- ⑫ **Douille d'antenne**
- ⑬ **Fonctionnement de station mobile**
- ⑭ **Vers la prise secteur**
- ⑮ **Borne d'alimentation CC**
- ⑯ **Noir-Gris**
- ⑰ **Rouge-Blanc**
- ⑱ **Fusible 20A**
- ⑲ **Relier la batterie à la borne d'alimentation CC**
- ⑳ **Batterie de 12 volts**
- ㉑ **Remarque: Utiliser soit la batterie soit l'alimentation secteur, mais pas les deux ensemble.**

- ① **Micrófono**
Podrá utilizarse un micrófono de baja impedancia o un micrófono de alta impedancia (de 500Ω a 50 kΩ). La llave PTT debe aislarse del circuito del micrófono (mostrado en [A]). Utilizar un micrófono con una llave y línea separadas para que pueda disponer de PTT y VOX.
- ② **Auriculares**
Utilizar auriculares de 4 a 16Ω de impedancia. Los auriculares opcionales HS-5 o HS-6 son los más apropiados para utilizarlos con el TS-430S.
- ③ **Los auriculares de tipo estéreo también pueden utilizarse.**
- ④ **Llave**
Para la operación CW, conectar la tecla a la toma KEY situada en el panel trasero. Utilizar un cable blindado.
- ⑤ **Conector para control remoto (REMOTE)**
Los accesorios externos pueden conectarse al TS-430S a través del conector REMOTE. El terminal PTT puede utilizarse para el control remoto de la operación de transmisión/recepción.
- ⑥ **Altavoz externo**
Además del altavoz incorporado, también puede utilizarse un altavoz externo. Conectar el altavoz externo a la toma EXT SP utilizando el enchufe suministrado.
- ⑦ **Terminal de tierra (GND)**
Para evitar la posibilidad de descargas eléctricas, interferencias con la recepción de programas de radiodifusión e interferencias de la TV, se recomienda que el cable de tierra esté conectado al terminal GND situado en la parte posterior del aparato.
- ⑧ **Operación a modo de estación fija**
- ⑨ **Pararrayos**
- ⑩ **Para la instalación de la antena de estación fija, ver la página 10.**
- ⑪ **Conector tipo UHF**
- ⑫ **Receptáculo para la antena**
- ⑬ **Operación a modo de estación móvil**
- ⑭ **Ala salida de CA**
- ⑮ **Terminal de alimentación de CC**
- ⑯ **Negro-Gris**
- ⑰ **Rojo-Blanco**
- ⑱ **Fusible de 20A**
- ⑲ **Conectar la batería al terminal de alimentación de CC**
- ⑳ **Batería de 12V**
- ㉑ **Nota: Utilizar bien la batería o la alimentación regulada pero no ambos.**

- ① **Micrófono**
È possibile usare un microfono a bassa o a alta impedenza (da 500Ω a 50 kΩ). L'interruttore PTT deve rimanere separato dal circuito del microfono (illustrato in [A]). Usare un microfono con interruttore linea MIC separati, così da poter usufruire del PTT e del VOX.
- ② **Cuffie**
Usare una cuffia con un'impedenza di 4 a 16Ω. Le cuffie opzionali HS-5 e HS-6 sono l'ideale per l'uso con il TS-430S.
- ③ **È pure possibile usare una cuffia stereo.**
- ④ **Tasto**
Per l'uso a CW, collegare il tasto alla presa KEY sul retro. Usare un cavo schermato.
- ⑤ **Pressa per collegamento a distanza (REMOTE)**
Gli accessori esterni possono essere collegati al TS-430S usando la presa REMOTE. Il terminale PTT può essere usato sia per il comando a distanza, come pure per la trasmissione/ricezione.
- ⑥ **Altoparlante esterno**
Benché l'apparecchio incorpori già un altoparlante, è possibile collegare un altro, esterno. Usare la presa EXT SP, sul retro, collegandovi i cavi con lo spinotto in dotazione.
- ⑦ **Terminale di massa a terra (GND)**
Si consiglia di collegare un filo di messa a terra a questo terminale, sul pannello posteriore, per prevenire qualsiasi scarica elettrica, TVI e BCI. Usare un cavo il più corto e pesante possibile.
- ⑧ **Usò come stazione fissa**
- ⑨ **Paratimone**
- ⑩ **Per l'installazione dell'antenna per la stazione fissa, vedere a pagina 10**
- ⑪ **Connettore tipo UHF**
- ⑫ **Pressa per antenna**
- ⑬ **Usò come stazione mobile**
- ⑭ **Ala presa di rete**
- ⑮ **Terminale alimentazione CC**
- ⑯ **Nero-grigio**
- ⑰ **Rosso-bianco**
- ⑱ **Fusibile 20A**
- ⑲ **Collegare la batteria al terminale CC**
- ⑳ **Batteria 12V**
- ㉑ **Nota: Usare la batteria o l'alimentazione di rete, ma non entrambe.**

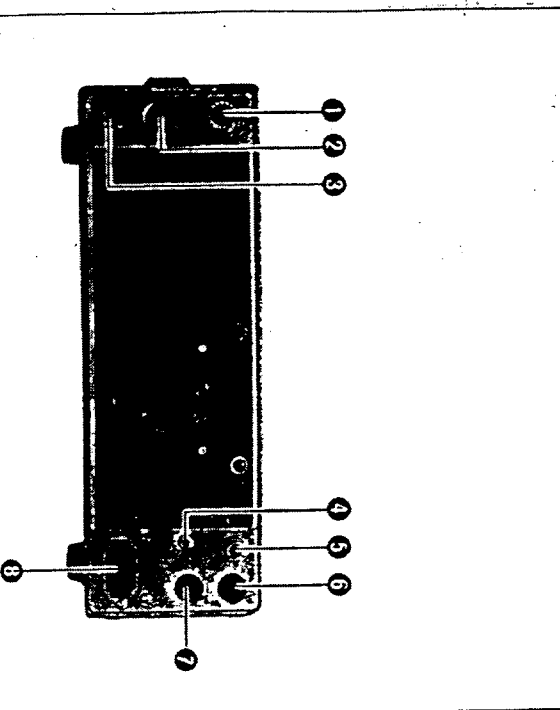
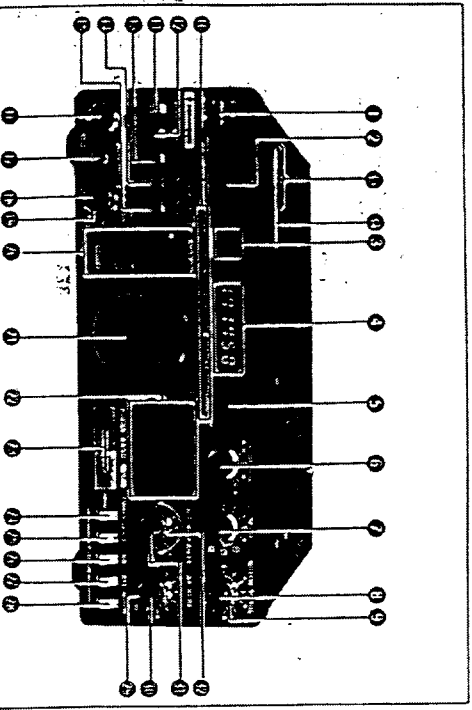

4.1 FRONT AND TOP PANELS (TS-430S shown)

- ① **POWER switch**
This switches the TS-430S ON and OFF.
Before operating the POWER switch, confirm that the VOX ⑫ is off, and the STANDBY switch ⑩ is set to the reception mode (REC).
- ② **METER**
The meter has three functions; two being selected by the METER switch. In receive, the meter is automatically an S-meter showing receive signal strength on a scale of 1-9, +20, +40 and +60 dB. In transmit, the meter shows IC or ALC level, depending on METER switch position.
- ③ **VFO Indicators**
VFO A indicator lights when VFO A is operating; VFO B indicator lights when VFO B is operating.
- ④ **Digital display**
The digital display indicates true operating frequency in all modes to an accuracy of 100 Hz.
- ⑤ **M.CH (Memory Channel) display**
Indicates memory channel 1 - 8 or P, program scan.
- ⑥ **FUNCTION switch**
This selects the VFO which will control receive and transmit frequencies. Select position A or B for normal operation; A-R and B-R for normal operation; A-R and B-R are used for split frequency or cross band operation.
A-R: VFO A operates during reception and VFO B during transmission.
A: VFO A operated; VFO B stands by.
B: VFO B operates; VFO A stands by.
- ⑦ **MEMORY CH selector**
This selects one of the eight memory channels. To write in a frequency depress the MIN switch and the displayed frequency will store in the selected channel. To recall from a memory channel, select the channel and depress the MR switch.
- ⑧ **NOTCH control**
Turn the NOTCH switch ⑧ ON to activate the notch filter. Adjust the notch frequency to null beat (carrier interference) signals.
- ⑨ **SQUELCH control**
The squelch control is used to eliminate noise during no signal time. This control may be adjusted clockwise until the noise disappears (threshold level). The control functions for all modes: SSB, AM and CW. In the FM mode, squelch functions only when the optional FM-430 is installed.
- ⑩ **Indicators**
ON AIR indicator: This lights during ON AIR in receive mode.
F LOCK (frequency lock): Lights when the F LOCK switch ⑬ is ON, indicating the VFO operating frequency is locked.
F STEP (frequency step): Lights when the STEP switch ⑭ is ON, indicating a fast VFO tuning rate.
RIT (Receiver Incremental Tuning): Indicates the RIT switch ⑮ is ON.
NOTCH: Indicates the notch filter is operating and lights when the NOTCH switch ⑯ is ON.
- ⑪ **STANDBY switch**
This switch selects:
REC: The transceiver is receiving unless the microphone PTT switch or the VOX circuit is activated.
SEND: Locks the unit in transmit. Transmission is locked out (reception only) if the selected transmission frequency is outside the amateur radio bands, or the final stage thermal protects is deactivated due to excessive heat-sink temperature.
- ⑫ **VOX switch**
Turn this switch on to activate the VOX (Voice Operated Xmit) during SSB, AM or FM operation or to allow semi-break-in CW operation.
- ⑬ **PROC (Speech processor) switch**
This switch is used during SSB or AM operation. At switch ON, the speech processor will be activated, increasing average "talk power".
- ⑭ **METER switch**
During transmission, the meter switch determines meter function. The switch selects between:
ALC - The meter monitors the output of the final stage power amplifier during transmission. During SSB operation, adjust the MIC control so that the meter pointer is within the ALC zone. Similarly, adjust the CAR control for CW operation. ALC does not indicate in the AM or FM mode.
IC - The meter monitors the final stage collector current.
12 - 19A is normal, 17A typical.
- ⑮ **NAR/WIDE switch**
This switch selects receive IF bandwidths when optional filters are installed.
The WIDE position provides the same IF bandwidth for both CW and SSB. For the NARROW position, optional filters are available for both CW and SSB. In the AM mode, the SSB filter is on in the narrow position.

⑳ MIC (Microphone) connector
 (8-pin)
 Microphone audio input. Frequency UP/DOWN control and PTT lines are included. The MC-42S or MC-60A microphones (optional) are recommended. MIC connector pin assignments are shown below

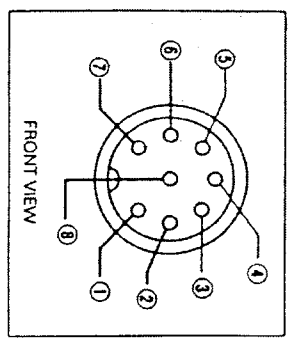

- ① MIC
- ② STBY
- ③ DOWN
- ④ UP
- ⑤ 8V
- ⑥ NC
- ⑦ GND MIC
- ⑧ GND Connection (STBY)

㉑ PHONES Jack
 The headphone jack allows use of 4 – 16 Ohm (or greater) impedance headphones. HS-5 or HS-6 optional headphones provide optimum results. Stereo-type headphones can also be used. Headphones will disable the internal or external speaker.

㉒ MIC (Microphone gain) control
 This control adjusts microphone amplifier gain for SSB and AM operation. In the SSB mode, adjust for an on-scale ALC reading at voice peaks. For low power operation, adjust this control below the ALC range.

㉓ CAR (CARRIER LEVEL) CONTROL
 This control adjusts carrier level during CW operation. Adjust the carrier level for an on-scale ALC meter reading. For low-power operation, adjust this control below the ALC range.

㉔ MODE switches and indicators
 These switches are used to select the mode: USB, LSB, CW, AM or FM (optional). Each indicator light corresponds to the mode.

㉕ Tuning Knob
 This knob controls the dual digital VFO's which operate in 10 Hz step at 10 kHz turn for normal slow tuning, or with the STEP switch depressed, at 100 Hz step for fast tuning.

㉖ Keyboard
 ● A – B switch: Depress this switch to equalize the frequency and mode of the idle VFO to that of the operating VFO.
 ● LOCK switch: This electrically locks the VFO frequency. When this switch is on, the tuned frequency does not vary when either the tuning knob or BAND switch is operated.

This is convenient when operating on the same frequency for extended periods. The RIT does operate with the LOCK switch on. The F.LOCK indicator lights to show operation.
 ● STEP switch: Used to select the VFO tuning rate.
 ● M.CH (Memory channel) switch: Used to select a memory channel as a fixed frequency. With this switch ON, the channel number is displayed on the M.CH display.
 ● MR (Memory recall) switch: Depress to recall a selected channel from memory to the VFO for tunable operation.
 ● MIN (Memory in) switch: Depress to store the displayed VFO frequency into a selected memory channel.
 ● MS (Memory scan) switch: Depress this switch for memory scan operation. Only channels with stored data are scanned. Scan rate is fixed at approximately 1.8 sec/channel.
 ● PGS (Program scan) switch: Depress this switch to scan from the frequency stored in CH 6 to the frequency stored in CH 10. Scan Speed is adjustable.

However, the presence of a signal does not stop the scan.
 ● HOLD (Scan hold) switch: Depress this switch to stop the scan operation. Resetting this switch to OFF resumes the scan operation.

㉗ BAND selector switches
 Used to select the amateur or frequency band. When the UP or DOWN switch is pressed, the band changes by one step.

㉘ 1 MHz step switch
 When depressed ON, this allows the band switch to raise or lower the frequency in 1 MHz steps within the transceiver's full frequency range. At OFF (out) the Band switch steps the amateur band.

㉙ RIT switch
 This push switch turns the RIT (Receiver Incremental Tuning) circuit ON and OFF. With the switch depressed, the circuit is activated and the RIT indicator is illuminated, allowing the receive frequency to be shifted by about 1 kHz independent of the transmit frequency by using the RIT control. The RIT circuit is turned OFF when the switch is out.

㉚ NB (Noise Blanker) switch
 This switch is used to reduce pulsating type ignition noises usually emitted from motor vehicles, Power-line, ORM and atmospheric "white" noise will not operate the noise blanker.

㉛ RF ATT (Attenuator) switch
 With this switch ON, a 20 dB attenuator is inserted in the antenna circuit, protecting the RF amplifier and mixer from overload on strong input signals.

㉜ NOTCH switch
 This switch controls the NOTCH circuit and indicator.
㉝ RF GAIN control
 This adjusts receiver RF amplifier gain. Turn fully clockwise for maximum gain and a correct S-meter reading.

㉞ AF GAIN (Audio Frequency) control
 This control adjusts the receiver audio output level. Volume increases as the control is turned clockwise.

㉟ RIT control
 When the RIT switch is ON, this will vary the receive frequency by about 1 kHz. When the control is set to the "0" center position, there is no frequency shift.
㊱ IF SHIFT control
 By using this control, the IF crystal filter center frequency can be shifted about 1 kHz, allowing adjustment of tone quality, or eliminating interference from adjacent frequencies. For normal operation, this control should be set to the center "0" position.

㊲ VOX controls
 VOX GAIN: This controls sensitivity of the VOX (voice operated Transmit) circuit. Adjust the gain for consistent key-over by voice, but not back ground noise.
 DELAY control: This controls hold time for VOX, or CW semi-break-in operation. Adjust to hold the transmitter on between words, at a normal speech and keying rate.
 ANTI-VOX control: This control is used to adjust the VOX system so that it is not false-tripped by sound from the speaker.

㊳ PG.SCAN (Program scan) control
 This adjusts program scan speed.

4.2 REAR PANEL

- ① ANT (Antenna) connector
 This UHF connector should be attached to a suitable antenna for transmitting and receiving. The antenna cable should be 50-ohm coax terminated with a PL-259 connector.
- ② X.VERTER (transverter) terminal
 This 8 Pin DIN connector is used to interface a VHF or UHF transverter.

③ GND (Ground) terminal
 To prevent electric shock as well as RFI and BCI, connect the transceiver to a good earth ground.

④ CW key jack
 Using shielded line, connect a key to this 1/4" phone jack for CW operation. Key open-terminal voltage is approximately 9V DC.

⑤ EXT. SP (External speaker) jack
 The receiver audio output can be connected through this jack to an external 4 to 16 ohm speaker. The internal speaker is disconnected when an external speaker is connected.

⑥ REMOTE connector
 This connector is used to interconnect a linear amplifier or other accessory item.
⑦ ACC (Accessory) connector
⑧ DC POWER CONNECTOR
 This is used to connect the DC power supply.



4.1 Frontplatte und Gehäuse-Obersseite

- ① Netzschalter (POWER)
 Zum Ein- und Ausschalten des Sendegerätes.
 Stellung ON (I) – ein, Stellung OFF (II) – aus.
 Vor Betätigung des Netzschalters unbedingt darauf achten, daß der VOX-Schalter ③ auf MAN und der Sendey/Empfangs-Schalter ⑤ auf REC eingestellt ist.
- ② Mehrzweck-Meßinstrument
 Dieses Instrument erfüllt drei Funktionen, von denen zwei mit dem Meßbereichs-Schalter 14 wählbar sind. Bei Empfangsbetrieb arbeitet das Instrument als S-Meter mit einem Anzeigebereich von S1-9, +20, +40 und +60 dB. Bei Sendebetrieb

5.1. RECEPTION

5.1.1. TS-430S RECEPTION

The TS-430S is ready for operation, then turn the POWER switch ON. The meter and digital display will illuminate, indicating the transceiver is in operation. The transmitter is fully solid-state, allowing reception as soon as the POWER switch is switched ON.

Advance the AF GAIN control clockwise until the receiver noise is heard from the speaker. Turn the main tuning control so the desired signal can be heard clearly.

5.1.2. RF ATTEN. SWITCH

When you attempt to receive RF amplifier attenuation approximately 20 dB, providing distortion-free reception. This feature may be used in cases of strong local signal, or during weak signal reception when a strong adjacent signal may blank the receiver.

5.1.3. NB SWITCH

The TS-430S has a sophisticated noise blanker designed to reduce ignition-type, pulse noise. The noise blanker is particularly important for mobile operation. When necessary, activate the noise-blanker by depressing the NB switch ON.

5.1.4. RF GAIN CONTROL

For normal operation, this control should be turned fully clockwise for maximum sensitivity. Receive sensitivity is reduced by turning the control counter-clockwise. Adjust the RF GAIN so the S-meter does not show excessive deflection. This minimizes noise during reception and allows the S-meter to indicate signal peak (or a little below that point). Noise is markedly reduced when signal is absent.

5.1.5. SQUELCH

To eliminate receiver noise at the no-signal condition, slowly advance the

squelch clockwise until the noise just disappears (threshold point). The squelch will open and the speaker will operate when a signal is received. If the signal is weak or fades, readjust the squelch for consistent reception.

5.1.5.2. NOTCH CONTROL

If a single tone such as a CW signal is superimposed on the receive signal, turn the NOTCH ON and adjust the NOTCH control to eliminate or minimize the beat signal. A beat of approximately 900 Hz can be eliminated at the center position of the control. The NOTCH is effective between 350 and 2600 Hz.

5.1.6. RIT CONTROL

By using the RIT (Receiver Incremental Tuning) control, the receive frequency can be shifted by about ± 1 kHz without changing the transmit frequency. If the frequency of the station you are working changes, your receive frequency can be reset by turning the RIT switch ON and adjusting the RIT control. Adjusting the control clockwise increases the frequency. When first calling another station, the RIT should be OFF, otherwise your transmit and receive frequency will not coincide.

5.1.7. IF SHIFT CONTROL

The IF SHIFT control is used to shift the passband of the IF filter without changing receive frequency. By turning this control in either direction, the IF passband is shifted as shown in Fig. 5-3.

The IF SHIFT is effective in eliminating interference when nearby signals are superimposed on the receive signal during either SSB or CW operation. IF SHIFT does not operate in the AM or FM modes.

(1) USB Mode (10 MHz and above)

Adjust the IF SHIFT control in the + direction and lower frequencies are cut. If the control is in the - direction and high frequencies are cut.

(2) **USB Mode (7 MHz and below)**
Adjust the control in the + direction and higher frequencies are cut. Adjust the control in the - direction and low frequencies are cut.

(3) CW Mode

By using the IF SHIFT in conjunction with the RIT, tone quality can be adjusted.

5.1.8. NAR-WIDE SWITCH OPERATION

For short to medium distance communication, the WIDE position may be used for both SSB and CW operation. For DX (long distance) communication, the NAR position will be an advantage in reducing interference. This feature, in combination with the IF SHIFT control, will provide outstanding interference rejection. The receive IF bandwidth is 2.4 kHz in the SSB and CW wide position, 270 or 500 Hz for CW (with optional filters YK-88CN or YK-88C) and 1.8 kHz for SSB with optional filter YK-88SN) in the NAR position.

*In the AM MODE without an optional filter, both WIDE NARROW positions are 2.4 kHz. With a YK-88A, Wide is 6 kHz and Narrow is 2.4 kHz.

*In transmit bandwidth is automatically WIDE.

PASSBAND WIDTH (-6 dB) KHZ

MODE	CW		SSB		AM	
	W	N	W	N	W	N
optional filter	2.4	2.4	2.4	2.4	2.4	2.4
YK-88C or CN	2.4	270	-	-	6	2.4
YK-88SN	-	-	2.4	1.8	6	2.4
YK-88A	-	-	-	-	6	2.4

W = WIDE
N = NARROW

NOTE: Without optional filters, there is no SSB or CW reception in the NAR switch position (*).

2. The NAR/WIDE switch does not function in the AM, FM mode.

3. Without an optional filter, the AM

mode bandwidth is 2.4 kHz

5.2. TRANSMISSION

CAUTION:

Before transmitting, be sure to connect an antenna or dummy load with a VSWR of less than 1.5:1. Never attempt to transmit with the antenna terminal left open.

When testing the transmitter, use a 50-ohm dummy load, rated at greater than 100W (TS-430S). Refer to Fig. 5-1 for initial control settings. When the TS-430S is ready for transmission, use the following procedure:

5.2.1 SSB Operation

1. Set the MODE switch to SSB.
2. Meter switch to ALC.
3. Standby switch to SEND.
4. Speak into the microphone and adjust the MIC GAIN for meter deflection within the ALC zone at signal peaks.
5. For QRP (low Power) operation, use less MIC GAIN and consult your external wattmeter for output level.

5.2.2 AM Operation

1. Set the MODE switch to AM and the meter switch to IC.
2. Place the STANDBY switch to SEND and adjust the CAR control so the meter registers approximately 2/3 its usual deflection.
3. Speak into the microphone and advance the MIC GAIN control so the meter deflects only slightly at peaks. Note that excessive meter deflection indicates overmodulation.
4. The PROC may be used to provide a more constant modulation level.

5.2.3 PROC (processor) operation

In DX (long distance) SSB or AM operation, it may be desirable to increase talk-power by using the speech processor.

The speech processor in the TS-430S combines an audio compression amplifier with changes in ALC time constant to provide extra audio punch, and increases average

SSB output power, while suppressing sideband splatter. To activate, turn on the PROC switch, and readjust MIC gain. Operated as described, distortion will be minimal. However, tone quality will be affected. It is therefore advisable to conduct normal operation with the processor disabled.

NOTE:

When a high-output microphone is used, input overload and distortion may result.

To prevent this, use an attenuator in the microphone circuit as shown below, or connect a 10 - 33k Ω resistor (depending on the microphone used) across the microphone input. (Mic control setting should be approximately 12 o'clock)

The MC-60A microphone is recommended (Microphone sensitivity -55 \pm 3dB for approx 5 cm distance to the mic). The MC-60A MIC AMP Switch should be set at the OUT position.

5.2.4 CW Operation

1. Set the MODE switch to CW and the meter switch to ALC.
2. Set the standby switch to SEND and adjust the CAR control so the meter deflects within the ALC zone. If a key is connected, it should be depressed during the adjustment.
3. For QRP operation, adjust the Carrier Control below the ALC point.

NOTE:

Full power operation (more than 5 minutes at ambient temperature of 25°C, in case of 10 MHz band, more than 30 seconds because of final efficiency), with the key kept depressed may result in unit trouble. At this time, pay attention to installation condition as well as ambient temperature, and decrease the power or operate the unit after an interval.

5.2.5 FM Operation (With FM-430 FM unit installed)

1. Place the MODE switch to FM.
2. Place the STANDBY switch to SEND.
3. Speak into the microphone. (In the FM mode, the MIC GAIN, CAR and meter switches are not used.)

5.2.6 FINAL STAGE PROTECTION

The TS-430S features a VSWR protection circuit to protect the final amplifier transistors. Three different protection circuits are used.

1. The final-stage transistors are protected by detecting VSWR of the antenna system and automatically lowering transmitter output power if the VSWR is too high.
2. When the heat-sink temperature rises, a detection circuit activates a cooling fan. Under normal conditions, this cooling fan sufficiently cools the heat sink.
3. The heat-sink temperature could rise abnormally during long transmissions, if the area adjacent to the heat-sink is blocked. In this case, the transmission is inhibited until the heat-sink cools to the proper temperature.

NOTES:

1. If transmitter output decreases due to activation of the protection circuit caused by high VSWR, carefully recheck and return the antenna system.
2. When the cooling fan starts to operate, determine that adequate airflow is possible in the heat-sink area.

● Operation of the Cooling Fan

The cooling fan operates when the heat-sink temperature rises to approximately 50°C (122°F) and ceases to operate when the temperature decreases to normal, approximately 40°C (104°F). The heat-sink is made of die-cast aluminum and is actually the rear panel. It must be kept clear of surrounding objects to allow heat to dissipate easily. The cooling fan is designed to oper-

ate when the heat-sink temperature is at a specific level, regardless of whether the unit is in transmit or receive mode.

5.2.7 MIC GAIN CONTROL

This control adjusts the microphone input level. When using the TS-430S in a voice mode, connect a microphone and set the STANDBY switch to SEND (an antenna or dummy load must be connected).

For SSB operation, set the meter switch to ALC and speak into the microphone. Adjust the MIC GAIN control so the meter does not deflect out of the ALC zone at signal peaks.

The TS-430S accepts either a low or high impedance microphone (500 Ω to 50 kΩ). When using a low impedance microphone (500 Ω), the MIC GAIN control should be advanced slightly higher than when a high impedance microphone is used, while observing the ALC meter.

● ALC (Automatic Level Control)

The ALC monitors the transmitter final stage output to minimize distortion in your transmitted signal. It automatically adjusts output to an optimum level.

5.3 VOX OPERATION

5.3.1 VOX SWITCH

VOX (voice operated transmit) is used to switch the TS-430S into transmit mode by your voice. Place the VOX switch ON and speak into the microphone. The transceiver automatically switches to transmit mode. Both the SEND switch and the MIC PTT switch are left in the REC position.

5.3.2 VOX GAIN CONTROL

This adjusts the VOX circuit sensitivity. Speak into the microphone at a normal voice level and adjust the control. Increased sensitivity allows transmission with a lower voice level. Transceiver operating condition (voice or transmit) can be checked by a ON AIR LED.

Note that if the control is advanced too far, the VOX circuit may be "tripped" by ambient noise.

5.3.3 ANTI-VOX CONTROL

This prevents the VOX circuit from being false-tripped by sound from the speaker.

Adjust the control so the VOX will not operate at the desired speaker volume level.

5.3.4 VOX DELAY CONTROL

This control adjusts the VOX circuit transmit hold time. If the hold time is too short, the transceiver will return to receive mode as soon as you stop talking into the microphone. This can be eliminated by advancing the control. Adjust the control for comfortable operation at a normal rate of speech.

5.4 SEMI-BREAK-IN OPERATION

The TS-430S has a built-in side-tone oscillator which, used in conjunction with the VOX circuit, allows semi-break-in operation, besides the conventional (SEND switch controlled) CW operation. During semi-break-in operation, the transceiver is placed in transmit mode when the key is depressed, and returns to receive mode when the key is released. The VOX circuit is activated by the side-tone.

For semi-break-in operation, set the VOX switch ON and the MODE switch to CW. Adjust the VOX GAIN to insure that the transceiver is set in transmit mode whenever the key is depressed. Also, adjust the VOX DELAY for the desired hold time. ANTI VOX adjustment is not required.

5.5 OPERATION WITH A LINEAR AMPLIFIER

The remote connector on the rear panel provides for interconnection with an amplifier. See the amplifier instruction manual to determine whether the linear requires a normally opened or normally closed (dur-

receive) relay contact. Connect the amplifier control line to either pin 5 (N.C.) or pin 4 (N.O. during receive). Connect the Ground (Shield) of the Control Line to Pin 2. Connect amplifier ALC to pin 6 of the remote connector. The TS-430S output is quite adequate to drive most amplifiers to full rated output.

5.6 CW OPERATION

For CW operation, your transmit frequency should be "zero-beat" to the transmit frequency of the station you are contacting. This also allows you to receive your signal without having to return his receiver. Tuning methods are detailed in the following paragraphs.

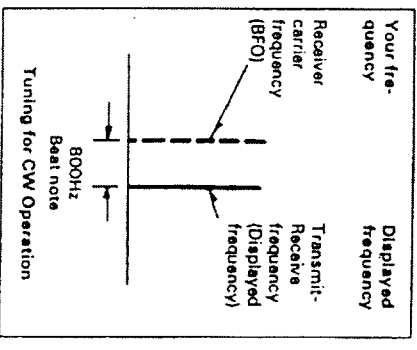

NOTE:

1. In CW mode, transmit frequency is displayed when both transmitting or receiving.
2. During CW operation, operating the BAND switch differs from other modes; for example, pressing the UP (BAND) switch at display frequency 14,000.0 shows as follows:
14,000.0 - 14,500.0 - 18,500.0 ... - UP
10,500.0 - 14,500.0 DOWN

5.6.1 OPERATION WITHOUT AN OPTIO... ALC CW FILTER

Set the IF SHIFT control to its center position and the RIT switch OFF. Adjust the main tuning control for an 800-Hz beat note and your transmit frequency will then coincide with that of your contact station ("zero-beat"). During reception, the side-tone monitor is activated by pressing down the key (NOX OFF). In this case, listen for the side-tone superimposed on the receive signal and adjust the main tuning for similar side-tone and incoming CW audio tone. By so doing, transmit frequencies will coincide. You may now adjust the RIT for a pitch which suits your preference. Interference is encountered, adjust the IF SHIFT. For more convenient and effective CW operation, use of the optional YK-88C or YK-88CN CW crystal filter is recommended.

5.6.2 OPERATION WITH A CW FILTER

Set the IF SHIFT to its center position and the RIT to OFF. Adjust the main tuning control for maximum deflection of the S-meter. Receive signal pitch will be about 800 Hz, indicating correct tuning.

5.6.3 KEY CONNECTION

When using an electronic keyer, make sure that polarity is set for positive. Always use shielded line from the key to transceiver.



5.1 EMPFANGSBETRIEB

5.1.1 Empfang

Zunächst die Antenne, das Mikrofon und die Morseastase anschließen. Dann die Flegler und Schalter gemäß Fig. 5-1 in die vorgeschriebenen Stellungen bringen. Nach erfolgreicher Grundeinstellung und nochmaliger Kontrolle aller Anschlüsse den Netzschalter (POWER) bis zum Einrasten drücken (Stellung ON). Die Skalenlampen des Meßinstru-

5.7 KEYBOARD FUNCTIONS/FUNKTIONEN DER SCHALTER UND TASTEN IM TASTENFELD/FONCTION DU CLAVIER/FUNCION DEL TECLADO/TASTIERA

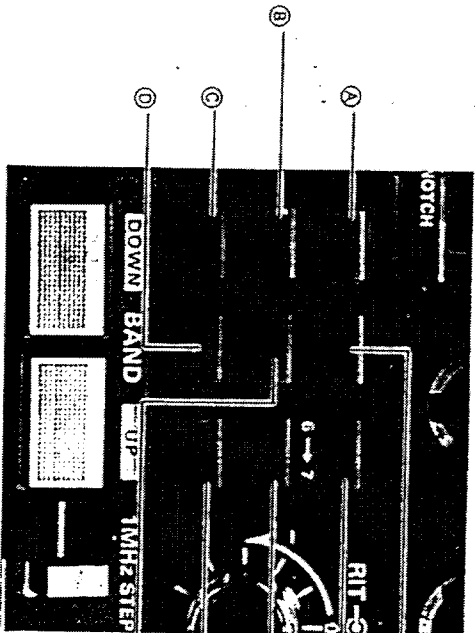

5.6.1 Uso senza filtro opzionale CW

Portare il comando IF SHIFT in posizione OFF. Regolare il comando principale di sintonizzazione per una nota di battimento di 800 Hz; la frequenza di trasmissione viene così a coincidere con quella della stazione contattata (battimento zero). Durante la ricezione, il controllo dell'effetto locale viene attivato premendo il tasto (VOX su OFF). In questo caso, ascoltare l'effetto locale superimposto al segnale e regolare la sintonizzazione principale per l'effetto locale e il tono audio CW in ingresso. Così facendo, le frequenze di trasmissione vengono a coincidere.

Regolare ora il RIT a piacimento. Se si incontrano ancora delle interferenze, regolare il comando IF SHIFT. Per un funzionamento CW ancora più comodo, ed efficace, si consiglia di usare il filtro opzionale di cristallo YK-88C o YK-88CN.

5.6.2 Uso del filtro CW

Portare il comando IF SHIFT in posizione centrale e il comando RIT in posizione OFF. Regolare il comando principale di sintonizzazione in modo da ottenere la massima deflessione dell'ago dell'indicatore dell'intensità del segnale (S). L'altezza del segnale ricevuto sarà di circa 800 Hz, il che corrisponde ad una sintonizzazione corretta.

5.6.3 Collegamento del tasto

Usando un tasto elettronico, controllare che la polarità sia regolata sul positivo. Usare sempre un cavo schermato per collegare il tasto alla ricevatrice.

- ⓐ Brings the idle VFO frequency and mode to that of the active VFO.
- ⓑ Switches to RAPID frequency step for VFO step tuning or program scanning. Step is 10 Hz in the normal position, and 100 Hz in the ON position.
- ⓒ Inputs both frequency and mode into a selected memory channel (CH 1-8).
- ⓓ Depress to recall a memory channel. Select the channel with the M.CH switch.
- ⓔ Depress to scan the memory channel.
- ⓕ Scans the range between CH 6 frequency and CH 7 frequency. During program scan hold the VFO control and the mode can be switched. When this switch is depressed, the channel selected by the M.CH switch is recalled to the VFO for tunable operation. The mode can also be controlled when recalled by the MR switch.

- ⓖ Synchronisiert Frequenz und Betriebsart des nicht benutzten VFOs mit der des aktiven VFOs.
- ⓗ Verrückt die Betriebsfrequenz. Frequenzschritt: 10 Hz-Normale Taste gedrückt: 100 Hz-Nasser Betrieb. In einen gewählten Betriebsart in einen gewählten Speicherkanal (Kanal 1 bis 8).
- ⓓ Zum Abrufen eines Speicherkanals drücken. Den Kanal mit dem M.CH-Schalter wählen.
- ⓔ Zum Absuchen der Speicherkanäle drücken.
- ⓕ Absuchen des Bereichs zwischen der Frequenz von Kanal 6 und der Frequenz von Kanal 7. Zum Abtasten des Suchbereichs drücken. Nach dem Anhalten des Suchbereichs wieder abtasten. Die Frequenz und die Betriebsart werden wieder an VFO übertragen und die Betriebsart entsprechend eingestellt.
- ⓖ Wenn dieser Schalter gedrückt wird, wird der mit dem M.CH-Schalter gewählte Kanal zur Abtastung in den VFO gegeben. Die geschichtete Betriebsart wird ebenfalls wieder eingestellt.

- ⓗ Maintien la fréquence VFO dévotée à la mode sur celui du VFO en service.
- ⓓ Introduit la fréquence de fonctionnement sur un gradin de fréquence rapide (RAPID) pour le record par gradins du VFO ou la balayage du programme. Sur la position normale, le gradin est de 10 Hz, et de 100 Hz sur la position ON.
- ⓔ Introduit la fréquence et le mode dans une mémoire de canal sélectionnée (CH 1 à 8).
- ⓕ Appuyer pour rappeler une mémoire de canal. Sélectionner le canal avec la touche M.CH.
- ⓖ Appuyer pour balayer la mémoire des canaux.
- ⓗ Balayer la gamme entre la fréquence du CH 6 et celle du CH 7.

- ⓓ Pone la frecuencia y el modo del VFO en reposo en los del VFO activo.
- ⓗ Bloquea la frecuencia de operación.
- ⓔ Conmuta el paso de frecuencia rápida para la sintonización por pasos del VFO o la exploración de programas. El paso es de 10 Hz en la posición normal y de 100 Hz en la posición ON.
- ⓕ Da entrada a la frecuencia y el modo en el canal de memoria seleccionado (canal 1 a 8).
- ⓖ Presionar para llamar un canal de memoria. Seleccionar el canal con la llave M.CH.
- ⓗ Presionar para explorar los canales de memoria.
- ⓔ Explora la gama entre la frecuencia del canal 6 y la frecuencia del canal 7.
- ⓕ Retiene la exploración. Durante la extensión de exploración de programas, la frecuencia puede sintonizarse con el control VFO y el modo puede conmutarse.
- ⓖ Cuando está presionada esta llave, el canal seleccionado por la llave M.CH se aplica al VFO para la operación de sintonización. El modo puede controlarse también al mantener la llave MR.

- ⓗ Uguaglia la frequenza e il modo del VFO non attivo alla frequenza e al modo di quello attivo.
- ⓔ Blocca la frequenza in uso.
- ⓖ Attiva il modo rapido di sintonizzazione a scaglioni VFO o di scansione del programma. Gli scaglioni sono di 10 Hz usando la posizione normale e di 100 Hz usando la posizione ON.
- ⓕ Immette la frequenza e il modo nel canale di memorizzazione selezionato (CH 1-8).
- ⓖ Premere per richiamare una memoria. Selezionare il canale per mezzo dell'interuttore M.CH.
- ⓗ Premere per scandire i canali di memorizzazione.
- ⓔ Scandisce la gamma di frequenza tra il canale 6 e 7.
- ⓖ Ferma la scansione. Durante il fermo scansione può essere sintonizzata con il comando VFO ed è possibile conmutare il modo.
- ⓖ Premendo questo interruttore, si richiama nel VFO il canale selezionato per mezzo dell'interuttore M.CH, per la sintonizzazione. Il modo può essere regolato anche dopo il richiamo per mezzo dell'interuttore MR.

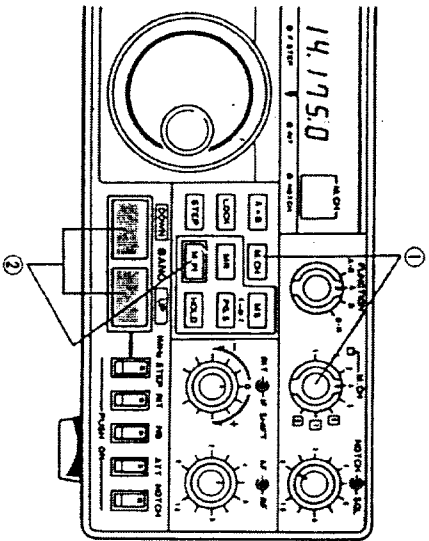

- ① Depress the M.CH switch, and place the M.CH switch to the unwanted memory channel.
- ② Simultaneously depress the BAND switch, and the MIN switch.

- ① Den M.CH-Schalter drücken und den M.CH-Schalter auf den nicht gewünschten Speicherkanal stellen.
- ② Den BAND-Schalter und den MIN-Schalter gleichzeitig drücken.

- ① Appuyer sur la touche M.CH, puis placer le sélecteur de mémoire de canal sur celle qui est à effacer.
- ② Appuyer simultanément sur le commutateur de gamme d'ondes (BAND) et sur la touche M.CH.

- ① Presionar la llave M.CH y ponerla en el canal de memoria indeseado.
- ② Presionar simultáneamente la llave M.CH y la llave MIN.

- ① Premere l'interruttore M.CH e portare il comando M.CH sul canale il cui contenuto deve essere cancellato.
- ② Premere l'interruttore di banda e MIN contemporaneamente.

● Erasing an unwanted frequency from memory

- Unwanted memory content can be erased.
1. Depress the M.CH switch, and select the channel to be erased with the M.CH switch.
 2. Simultaneously depress the BAND switch (either UP or DOWN), and the MIN switch.
 3. The display will clear, and only the decimal points will display. All mode indicators will remain off.

● Löschen gespeicherter Feertkanal-Frequenzen

- Die in einem Speicherkanal gespeicherte, nicht mehr gewünschte Frequenz wird wie folgt gelöscht:
1. Schalter M. CH drücken und den zu löschenden Kanal mit dem Kanal-Schalter (M. CH) anwählen.
 2. Die Tasten BAND (UP oder DOWN) und M. IN gleichzeitig drücken.
 3. Die Digitalanzeige wird bis auf die Dezimalpunkte gelöscht. Die Betriebsarten-Leuchtdiagnose bleibt dunkel.

● Effacement d'une fréquence superflue de la mémoire

- Le contenu superflu de la mémoire peut être effacé.
1. Appuyer sur la touche M.CH (mémoire de canal) puis sélectionner le canal devant être effacé avec cette même touche.
 2. Appuyer simultanément sur le commutateur de gamme d'ondes (BAND, UP ou DOWN) et sur la touche M. IN (entée de mémoire).
 3. L'affichage est alors effacé, et seuls les points décimaux restent à l'affichage. Tous les indicateurs de mode restent éteints.

● Borrado de una frecuencia indeseada de la memoria

- Los contenidos de la memoria que no se deseen pueden borrarse.
1. Presionar la llave M.CH y seleccionar el canal que quiera borrarse con la llave M.CH.
 2. Presionar simultáneamente la llave BAND (bien UP o DOWN) y la llave MIN.
 3. La indicación se borrará y solamente quedarán indicados los puntos decimales. Todos los indicadores de modo permanecerán apagados.

● Cancellazione di una memorizzazione

- Per cancellare una memorizzazione, procedere come segue:
1. Premere l'interruttore M. CH e selezionare il canale di memorizzazione di cui si vuole cancellare il contenuto per mezzo dell'altro comando M. CH.
 2. Premere l'interruttore BAND (UP o DOWN) e l'interruttore M. IN contemporaneamente.
 3. La visualizzazione del quadrante viene cancellata, lasciando solo il simbolo della virgola. Tutti gli indicatori del modo rimangono spenti.

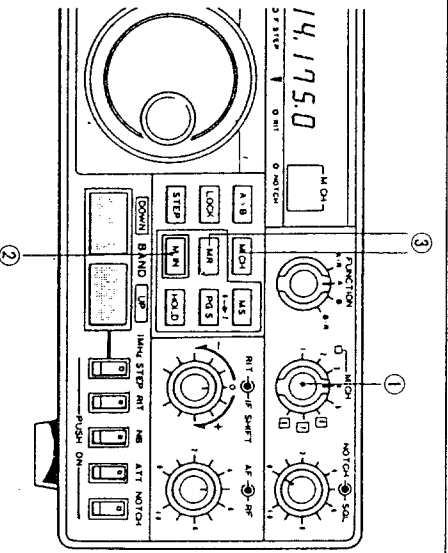

- | | |
|---|--|
| ① | Select a memory channel. |
| ② | Store the memory. |
| ③ | These switches are for recalling memory. |
- | | |
|---|--|
| ① | Einen Speicherkanal wählen. |
| ② | Speichern. |
| ③ | Diese Schalter dienen zum Abrufen der Speicherung. |

- | | |
|---|--|
| ① | Selezione un canale di memorizzazione. |
| ② | Armacenar la memoria. |
| ③ | Estas llaves son para llamar la memoria. |
- | | |
|---|--|
| ① | Selezione un canale di memorizzazione. |
| ② | Premere per memorizzare. |
| ③ | Usare questi interruttori per richiamare la memoria. |

● M.CH (Memory channel) operation

The TS-430S has eight memory channels. The memory permits input of both frequency and mode, and this data will be permanently retained (by the built-in lithium battery).

1. The M.CH switch selects the desired channel from CH 1-8.
2. When the M.CH switch is depressed, a "beep" sounds, indicating memory input.
3. There are two recall modes for memory channel contents.

- * Depress the M.CH switch. Any one of eight channels can be selected by the M.CH switch as a fixed (non-tunable) frequency and mode.
- * Depress the MR switch. The channel designated by the M.CH switch is recalled to the VFO for tunable operation. The memory contents are not changed.

● Festfrequenzbetrieb

Der TS-430S verfügt über acht Speicherplätze, die sog. Speicher- oder Fest-Kanäle, in denen nicht nur die Betriebsfrequenzen, sondern auch die Betriebsart gespeichert werden können. Die eingebaute Lithium-Langleitbatterie dient zur Speicherhaltung und verhindert ein Löschen der gespeicherten Informationen.

1. Den gewünschten Speicherkanal (1-8) mit dem Kanal-Drehschalter (M.CH) vorwählen.
2. Bei Betätigung der Eingabe-Taste (M.IN) ertönt ein Pfeifton mit dem die Eingabe der Frequenz und Betriebsart quittiert wird.
3. Die in den Festkanälen gespeicherten Informationen lassen sich wie folgt abrufen:

- * Schalter M.CH drücken. Jeder der acht Speicherkanäle läßt sich mit dem Kanal-Drehschalter (M.CH) als Festfrequenzkanal mit vorgegebener Betriebsart abrufen.
- * Taste MR drücken. Der mit dem Kanal-Drehschalter (M.CH) vorgewählte Kanal wird zur Feinabstimmung auf den VFO übertragen. Der Speicherinhalt bleibt jedoch erhalten.

● Fonctionnement de la mémoire de canal (M.CH)

Le TS-430S comporte huit mémoires de canal. La mémoire permet d'introduire la fréquence et le mode, et ces données restent enregistrées de manière permanente (grâce à la pile au lithium intégrée).

1. Le sélecteur M.CH permet de sélectionner le canal choisi parmi les huit existants.
2. Lorsque la touche d'entrée de mémoire (M.IN) est enclenchée, un "bip" résonne, ce qui indique la mise en mémoire.
3. Il y a deux modes de rappel pour le contenu des mémoires de canal.

- * Appuyer sur la touche M.CH. On peut sélectionner n'importe lequel des huit canaux à l'aide du sélecteur M.CH en tant que fréquence fixe (non accordable) et mode.
- * Appuyer sur la touche MR (mémoire). Le canal choisi par le sélecteur M.CH est rappelé vers le VFO pour l'opération d'accord. Le contenu de la mémoire ne change pas.

● Operación del canal de memoria (M.CH)

El TS-430S tiene ocho canales de memoria. La memoria permite la entrada de frecuencia y modo, y estos datos se retendrán permanentemente gracias a una pila de litio incorporada.

1. La llave M.CH selecciona el canal deseado desde CH 1 a CH 8.
2. Cuando se presiona la llave M.CH, se oirá un sonido que indicará la entrada en memoria.
3. Hay dos modos de llamada de los contenidos del canal de memoria.

- * Presionar la llave M.CH. Cualquiera de los ocho canales podrá seleccionarse con la llave M.CH, como frecuencia fija (no puede sintonizarse) y modo.
- * Presionar la llave MR. El canal designado por la llave M.CH se llama al VFO para efectuar la operación sintonizable. Los contenidos de la memoria no se cambian.

● Uso dei canali di memorizzazione (M.CH)

Il TS-430S è dotato di otto canali di memorizzazione. È possibile memorizzare la frequenza e il modo; questi dati vengono conservati da una batteria al litio incorporata.

1. Usare l'interruttore M.CH per selezionare un canale di memorizzazione, da CH 1 a 8.
2. Premendo l'interruttore M.IN, si sente un bip, a riconferma dell'avvenuta memorizzazione.
3. Il contenuto di un canale di memorizzazione può essere richiamato in due modi:

- * Premere l'interruttore M.CH. Si può così selezionare uno qualsiasi degli otto canali, per mezzo dell'interruttore M.CH. La frequenza e il modo richiamati sono fissi (e cioè non sintonizzabili).
- * Premere l'interruttore MR. Il canale designato dall'interruttore M.CH viene richiamato al VFO e può essere sintonizzato. Il contenuto della memoria non viene comunque modificato.

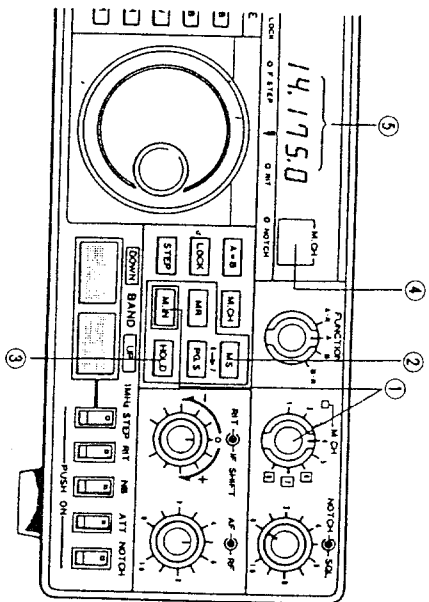

- ① Stores frequency and mode.
- ② Depress to initiate memory scan.
- ③ Release to resume scan.
- ④ Displays the memory channel.
- ⑤ Displays the stored frequency.

- ① Speicherung der Frequenz und Betriebsart.
- ② Drücken, um den Speichersuchlauf zu starten.
- ③ Drücken, wenn das gewünschte Signal empfangen wird.
- ④ Anzeige des Speicherkanals.
- ⑤ Anzeige der gespeicherten Frequenz.

- ① Met en mémoire la fréquence et le mode.
- ② Appuyer pour mettre en marche la base de mémoire.
- ③ Appuyer lorsque la circulation voulue est reçue. Libérer pour reprendre le base.
- ④ Affiche le canal de la mémoire.
- ⑤ Affiche la fréquence mise en mémoire.

- ① Almacena la frecuencia y el modo.
- ② Presionar para iniciar la exploración de la memoria.
- ③ Presionarla cuando se reciba el tráfico deseado.
- ④ Liberarla para renudar la exploración.
- ⑤ Indica la frecuencia almacenada.

- ① Memorizza la frequenza e il modo.
- ② Premere per dare inizio alla scansione della memoria.
- ③ Premere quando si incontra la combinazione frequenza/modo desiderata.
- ④ Liberare per continuare la scansione.
- ⑤ Visualizza il canale di memorizzazione.
- ⑤ Visualizza la frequenza memorizzata.

● Memory scan operation

- 1. Input frequencies and modes to be scanned into the memory channels.
- 2. Depress the MS switch. The channel number and frequency of each occupied channel is displayed. Scan interval is approximately 1.8 seconds per channel.
- 3. When the desired traffic is received during scan, depress the HOLD switch.
- 4. Scan will resume by releasing the HOLD switch.

NOTES:

- 1. The channel eight transmit frequency is not scanned.
- 2. When memories are empty, is displayed and there is no scan.
- 3. Scan is held by transmitting, and resumes when the transceiver returns to the receive mode.

● Kanal-Suchlauf

- 1. Gewünschte Frequenz und Betriebsart in den vorgewählten Speicherkanal eingeben.
- 2. Den Speicherkanal-Suchlauf-Schalter (MS) drücken. Die Nummern der belegten Speicherkanäle und die darin gespeicherten Frequenzen werden angezeigt. Die Suchlaufgeschwindigkeit beträgt etwa 1.8 Sekunden pro Kanal.
- 3. Wird das gewünschte Signal beim Suchlauf empfangen, den Anhalte-Schalter (HOLD) drücken.
- 4. Durch Auslösen des Anhalte-Schalters (HOLD) wird der Suchlauf fortgesetzt.

HINWEISE:

- 1. Die im Festkanal 8 gespeicherte Sendefrequenz wird nicht vom Suchlauf erfasst.
- 2. Bei nicht belegten Festkanälen erscheint das Symbol/ auf der Anzeige. Speicherkanal-Suchlauf ist dann nicht möglich.
- 3. Der Suchlauf wird beim Übergang auf Sendebetrieb automatisch abgebrochen und beim Umschalten auf Empfangsbetrieb fortgesetzt.

● Balayage de mémoire

- 1. Introduire les fréquences et les modes devant être balayés dans les mémoires des canaux.
- 2. Appuyer sur la touche MS (balayage de mémoire).
- Le numéro de canal et la fréquence de chaque canal occupé est affiché. L'intervalle de balayage est d'environ 1,8 seconde par canal.
- 3. Lorsque la circulation voulue est reçue durant le balayage, appuyer sur la touche de maintien (HOLD).
- 4. Le balayage reprend lorsqu'on libère la touche HOLD.

REMARQUES:

- 1. La fréquence de transmission du canal huit n'est pas balayée.
- 2. Lorsque les mémoires ne sont pas occupées, le signe est affiché et il ne se produit aucun balayage.
- 3. Le balayage est suspendu lors de la transmission, et reprend lorsque l'émetteur-récepteur revient sur le mode de réception.

● Operación de exploración de la memoria

- 1. Dar entrada a las frecuencias y modos, que han de ser explorados, en los canales de memoria.
- 2. Presionar la llave MS. El número de canal y la frecuencia de cada canal ocupado quedarán indicados. El intervalo de exploración es de aproximadamente 1,8 segundos.
- 3. Cuando se reciba el tráfico deseado durante la exploración, presionar la llave HOLD.
- 4. La exploración se reanudará al liberar la llave HOLD.

NOTAS:

- 1. La frecuencia de transmisión del canal ocho no se explora.
- 2. Cuando las memorias estén vacías, se indica y no hay exploración.
- 3. La transmisión retiene la exploración, y ésta se reanuda cuando el transceptor vuelva al modo de recepción.

● Scansione della memoria

- 1. Impostare le frequenze e i modi da scandire nei canali di memorizzazione.
- 2. Premere l'interruttore MS. Vengono così visualizzati il numero del canale e la frequenza di ogni canale di memorizzazione occupato. Il tempo di scansione è di circa 1,8 secondi per canale.
- 3. Quando, durante la scansione, si arriva sulla stazione desiderata, premere l'interruttore di sospensione della scansione (HOLD).
- 4. Liberando l'interruttore HOLD, la scansione continua.

NOTE:

- 1. La frequenza di trasmissione del canale 8 non viene scandita.
- 2. Quando un canale di memorizzazione è vuoto, nel quadrante viene visualizzato .
- 3. La scansione viene sospesa anche durante la trasmissione: essa riprende quando si ritorna al modo di ricezione.

urnawp...

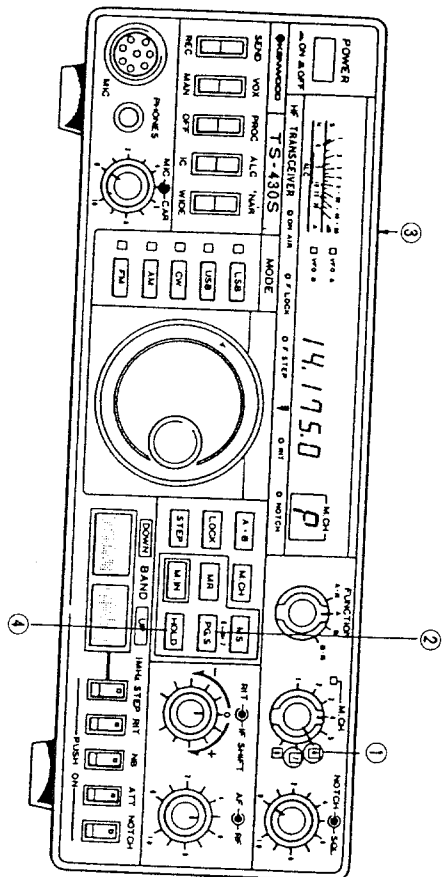

- ① Input the lower frequency limit and mode into "6", and the upper frequency limit into "7".
- ② When depressed, the letter **[P]** displays and scan begins.
- ③ This control varies the scan speed (on top cover).
- ④ Depress to hold a frequency. Turn off to continue scanning.

- ① Die untere Grenzfrequenz und die Betriebsart in „6“ eingeben und die obere Grenzfrequenz in „7“.
- ② Nach Drücken wird der Buchstabe **[P]** angezeigt und der Suchlauf beginnt.
- ③ Dieser Regler (oben auf dem Gerät) verändert die Suchlauf-Geschwindigkeit.
- ④ Drücken, um den Suchlauf anzuhalten. Auslösen, um den Suchlauf fortzusetzen.

- ① Introduire la limite de la fréquence inférieure et le mode dans le canal 6 et la limite de la fréquence supérieure dans le canal "7".
- ② Lorsque cette touche est enclenchée, la lettre **[P]** est affichée et le balayage commence.
- ③ Cette commande permet de varier la vitesse de balayage (sur la façade supérieure).
- ④ Appuyer pour suspendre une fréquence. Désenclencher pour reprendre le balayage.

- ① Dar entrada al límite de frecuencia inferior y al modo en "6" y al límite de frecuencia superior en "7".
- ② Cuando este presionada, la letra **[P]** se indica y se inicia la exploración.
- ③ Este control varía la velocidad de exploración (está situado en la tapa superior).
- ④ Presionar para retener una frecuencia. Liberarlo para continuar la exploración.

- ① Immagazzinare il limite inferiore della frequenza ed il modo nel canale 6 e il limite superiore nel canale 7.
- ② Premendo questo interruttore, nel quale appare **[P]** e la scansione inizia.
- ③ Usare questo comando (sul pannello superiore) per regolare la velocità di scansione.
- ④ Premere per fermare una frequenza. Liberare per continuare la scansione.

● Program scan operation

1. Program the scanning frequency range.
2. Input the lower (or upper) frequency limit and mode into CH 6 (using the MIN switch). Then, input the upper (or lower) frequency limit into CH7.
3. Depress the P.G.S switch to initiate scan. The letter P will display during program scan.

● Programmierbarer Suchlauf

1. Zunächst den gewünschten Suchlaufbereich vorprogrammieren.
 2. Die untere (oder obere) Grenzfrequenz des Suchlaufbereichs im Kanal 6 mit der Eingabetaste (M, IN) speichern, dann die obere (oder untere) Grenzfrequenz im Kanal 7 speichern.
 3. Zur Auslösung des Suchlaufs den Schalter P.G.S. drücken.
- Während des Suchlaufs erscheint auf der Kanal-Anzeige (M, CH.) der Buchstabe P.

● Balayage de programme

1. Programmer la gamme de fréquence de balayage.
2. Introduire la limite de la fréquence inférieure (ou supérieure) et le mode dans le CH 6 (à l'aide de la touche M, IN). Introduire ensuite la limite de la fréquence supérieure (ou inférieure) dans le CH 7.
3. Appuyer sur la touche P.G.S (balayage de programme) pour commencer le balayage. La lettre P est affichée durant le balayage de programme.

● Operación de exploración de programas

1. Programar la gama de frecuencias de exploración.
2. Dar entrada al límite de frecuencia inferior (o superior) y al modo en el CH 6 (utilizando la llave MIN). Luego, dar entrada al límite de frecuencia superior (o inferior) en el CH 7.
3. Presionar la llave P.G.S para iniciar la exploración. Durante la exploración de programas quedará indicada la letra P.

● Scansione del programma

1. Programmare la gamma di frequenza da scandire.
2. Impostare il limite inferiore (o superiore) della frequenza e il modo nel canale 6 (CH 6), facendo uso dell'interruttore M, IN. Impostare quindi il limite superiore (o inferiore) nel canale 7.
3. Premere l'interruttore P.G.S per dare inizio alla scansione. Durante la scansione del programma, nel quale appare la lettera P.

4. The scan speed is adjustable using the speed control on the top panel, along with the STEP switch. Select the scan speed appropriate for the selected frequency and mode.

5. When the desired station is received and that frequency is to be held, depress the HOLD switch. Then, adjust the VFO for best tuning. During hold, the mode may be temporarily changed. When Hold is released, the mode will revert to the original programmed mode setting after one scan cycle.

6. After the CH 7 upper (or lower) frequency limit has been reached, a "beep" sounds and the scan repeats from the CH 6 frequency.

NOTE:

1. Program scan is from CH 6 to CH 7, only.
2. During scan, only the CH 6 mode is used.
3. During scan or scan hold, a frequency can be stored into a memory channel selected by the M,CH switch by depressing the MAIN switch.
4. When the scan is on and the STEP switch is depressed, the step is 100 Hz.
5. When CH 6 and CH 7 are empty, there can be no scan.
6. Scanning is stopped during transmit and resumed after return to the receive mode.

4. Die Suchlaufgeschwindigkeit lässt sich am Geschwindigkeits-Regler (SPEED) (auf der Gehäuse-Oberseite) in Verbindung mit dem Raster-Schalter (STEP) nach Bedarf einstellen. Dabei die für den betreffenden Frequenzbereich und die Betriebsart geeignete Suchlaufgeschwindigkeit wählen.

5. Beim Empfang der gewünschten Gegenstation den Anhalte-Schalter (HOLD) zum Anhalten des Suchlaufs drücken, dann die Feinabstimmung am VFO vornehmen.

Nach dem Anhalten des Suchlaufs kann vorübergehend auf eine andere Betriebsart umgeschaltet werden. Nach Auslösen des Anhalte-Schalters (HOLD) schaltet das Gerät nach einem Suchlaufdurchgang wieder auf die ursprüngliche Betriebsart um.

6. Nachdem der Suchlauf die im Kanal 7 gespeicherte obere (oder untere) Grenzfrequenz erreicht hat, ertönt ein Signalton und der Suchlauf beginnt von vorn bei dem im Kanal 6 gespeicherten Grenzfrequenz.

HINWEISE:

1. Programmierbarer Suchlauf ist nur innerhalb des durch die Kanäle 6 und 7 vorgegebenen Frequenzbereichs möglich.
2. Während des Suchlaufs ist nur der im Kanal 6 gespeicherte Betriebsart maßgeblich.
3. Während des Suchlaufs oder der Suchlaufpausen, lässt sich eine beliebige Frequenz in einem am Kanal-Drehschalter (M, CH) vorgewählten Speicherkanal durch Betätigung der Eingabe-Taste (M, IN) einlesen.
4. Wird der Raster-Schalter (STEP) während des Suchlaufs betätigt, arbeitet der Transceiver mit einem Suchlaufschritt von 100 Hz.
5. Sind keine Grenzfrequenzen in die Kanäle 6 und 7 eingegeben worden, ist kein programmierbarer Suchlauf möglich.
6. Der Suchlauf wird bei Übergang auf Sendebetrieb sofort abgebrochen und bei Wiederaufnahme des Empfangsbetriebs fortgesetzt.

4. On peut régler la vitesse de balayage à l'aide de la commande de vitesse se trouvant sur le panneau supérieur, et du commutateur à gradins (STEP). Sélectionner une vitesse de balayage appropriée à la fréquence et au mode chois.

5. Lorsque la station choisie est reçue et que sa fréquence doit être maintenue appuyer sur la touche HOLD. Régler ensuite le VFO pour obtenir le meilleur accord. Pendant la suspension, le mode peut temporairement changer. Lorsque la suspension est libérée, le mode revient sur le mode d'origine programmé après un cycle de balayage.

6. Après avoir atteint la limite de la fréquence supérieure (ou inférieure) du CH 7, un "bip" résonne et le balayage reprend à partir de la fréquence du CH 6.

REMARQUE:

1. Le balayage de programme se fait uniquement du CH 6 au CH 7.
2. Durant le balayage, seul le mode CH 6 est utilisé.
3. Durant le balayage ou le maintien (suspension) du balayage, on peut mettre en mémoire une fréquence dans un canal sélectionné par le sélecteur M, CH en appuyant sur la touche M, IN.
4. Lorsque le balayage est en cours et que le commutateur à gradins est enclenché, le gradin est de 100 Hz.
5. Il ne peut y avoir de balayage lorsque les CH 6 et CH 7 ne sont pas occupés.
6. Le balayage est arrêté pendant la transmission et reprend après le retour sur le mode de réception.

4. La velocidad de exploración puede ajustarse gracias al control de velocidad situado en el panel superior, junto con la llave STEP. Seleccionar la velocidad de exploración apropiada para el modo y la frecuencia seleccionados.

5. Cuando se recibe la estación deseada y esa frecuencia ha de retenerse, presionar la llave HOLD. Luego, ajustar el VFO para obtener la mejor sintonización. Durante la retención, el modo podrá cambiar temporalmente. Cuando se libere la retención, el modo volverá al ajuste original de modo programado una vez de haber transcurrido un ciclo de exploración.

6. Una vez alcanzado el límite de frecuencia superior (o inferior) del canal 7, suena un aviso y la exploración se repite desde la frecuencia del canal 6.

NOTAS:

1. La exploración de programas es solamente desde el canal 6 al 7.
2. Durante la exploración solamente se utiliza el modo del canal 6.
3. Durante la exploración o retención de exploración podrá almacenarse una frecuencia en un canal de memoria seleccionado por la llave M,CH presionando para ello la llave MAIN.
4. Cuando la exploración esté activa y la llave STEP esté presionada, el paso es de 100 Hz.
5. Cuando los canales 6 y 7 estén vacíos no habrá exploración.
6. La exploración cesa durante la transmisión y se reanuda después de volver al modo de recepción.

4. La velocità di scansione può essere regolata per mezzo del comando apposito ubicato sul pannello superiore dell'apparecchio. Selezionare la velocità di scansione più appropriata per la frequenza e il modo selezionati.

5. Quando si incontra la stazione desiderata, premere l'interruttore di sospensione della scansione (HOLD) per fermare la frequenza corrispondente. Regolare quindi il VFO in modo da ottenere la miglior sintonizzazione della scansione. È possibile modificare il modo, provvisoriamente. Liberando l'interruttore HOLD, il modo ritorna ad essere quello originale.

6. Al raggiungimento del limite superiore (o inferiore) del canale 7, si sente un bip, e la scansione si ripete a partire dalla frequenza del canale 6.

NOTE:

1. La scansione viene eseguita solo dal canale 6 al canale 7.
2. Durante la scansione viene usato solo il modo del canale 6.
3. Durante la scansione e la sospensione della scansione è possibile memorizzare il canale selezionato per mezzo dell'interruttore M, CH, premendo l'interruttore M, IN.
4. Durante la scansione, se si preme l'interruttore STEP, gli scaglioni di sintonizzazione sono di 100 Hz.
5. Se i canali 6 e 7 sono vuoti, nessuna scansione è possibile.
6. La scansione viene interrotta durante la trasmissione e riprende quando l'apparecchio ritorna al modo di ricezione.

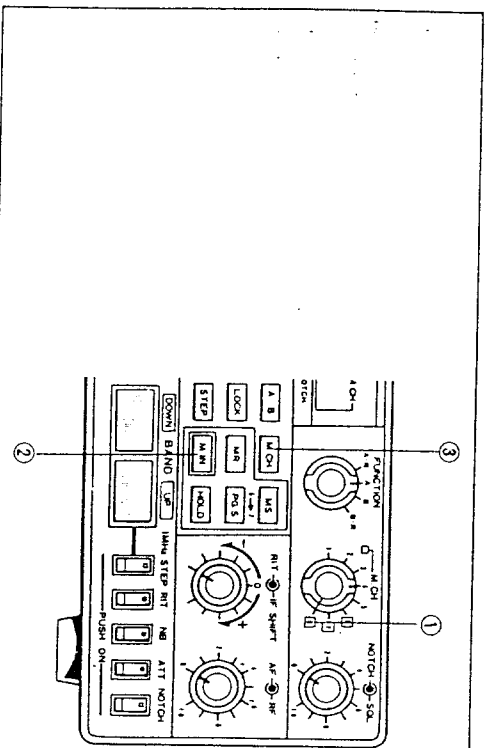

- ① Place at "8".
- ② Input the reception frequency, then the transmit frequency.
- ③ Pressing the switch TWICE allows transmission and reception on different frequencies.
- ④ Auf "8" stellen.
- ⑤ Die Empfangsfrequenz eingeben, danach die Sendefrequenz.
- ⑥ Durch Drücken dieses Schalters ist Sende- und Empfangsbetrieb mit unterschiedlichen Frequenzen möglich (auch auf unterschiedlichen Bändern und Betriebsarten).

- ① Régler sur "8".
- ② DEUX appuis consécutifs sur cette touche permettent d'établir la transmission et la réception sur des fréquences différentes.
- ③ Introduire la fréquence de réception puis la fréquence de transmission.

- ① Ponerla en "8".
- ② Presionando DOS VECES esta llave es posible la transmisión y recepción en diferentes frecuencias.
- ③ Dar entrada a la frecuencia de recepción y luego a la frecuencia de transmisión.
- ④ Portare su 8.
- ⑤ Premendo questo interruttore due volte, si può trasmettere e ricevere su due frequenze diverse.
- ⑥ Impostare prima la frequenza di ricezione e poi quella di trasmissione.

● **Memory CH 8 reception and transmission operation**

1. Place the M.CH switch to "8".
2. Input the reception frequency and mode using the M.I.N. switch.
3. The usual data entry "beep" is emitted as a pulse train. Input the transmission frequency (and mode).
4. The "beep" ceases.
5. Depress the M.CH switch. "Split" frequency operation (transmission and reception on different frequencies are programmed into CH 8).

NOTE: Different modes and/or bands can also be programmed for transmission and reception.
2. If the M.I.N. switch is depressed twice in succession, this memory can be used as an ordinary memory, now having the same frequency for both transmission and reception.

● **Sende- und Empfangsbetrieb auf dem Speicherkanal 8**

1. Den Kanal-Dreheschalter (M. CH.) auf "8" einstellen.
2. Die Empfangsfrequenz und Betriebsart durch Drücken der Taste M. I.N. in den Festkanal 8 eingeben.
3. Die Eingabe dieser Daten wird durch einen andauernden Signalton (Impulsfolge) quittiert. Anschließend die Senderfrequenz und Betriebsart in der gleichen Weise eingeben.
4. Nach beendeter Eingabe verstummt der Signalton.
5. Den Schalter M. CH drücken. Dadurch wird der Transceiver auf Sende- und Empfangsbetrieb mit unterschiedlichen Frequenzen im Speicherkanal 8 programmiert.

HINWEISE:
1. Es ist auch möglich, unterschiedliche Betriebsarten und/oder Bänder für Sende- und Empfangsbetrieb zu programmieren.
2. Durch zweimaliges aufeinanderfolgendes Drücken der Taste M. I.N. kann der Semi-Duplex-Speicherkanal 8 als normaler Speicherplatz umgeschaltet werden. Der Transceiver arbeitet dann in Simplexbetrieb mit gleicher Sende- und Empfangsfrequenz.

● **Réception et transmission de la mémoire du canal 8 (CH 8)**

1. Mettre le sélecteur M. CH sur "8".
2. Introduire la fréquence de réception et le mode à l'aide de la touche M. I.N.
3. Le "bip" habituel d'entrée de données est émis comme un train d'impulsions. Introduire la fréquence de transmission (et le mode).
4. Le "bip" cesse de résonner.
5. Appuyer sur la touche M. CH. Fonctionnement de la fréquence "fractionnée" (La transmission et la réception sur des fréquences diverses sont programmés dans le canal 8).

REMARQUE:
1. Des modes et/ou des gammes d'ondes (bandes) divers peuvent également être programmés pour la transmission et la réception.
2. Si on appuie deux fois de suite sur la touche M. I.N., cette mémoire peut être utilisée en tant que mémoire normale, ayant alors la même fréquence en transmission et en réception.

● **Operación de transmisión y recepción del CH 8 de memoria**

1. Poner la llave M.CH en "8".
2. Dar entrada a la frecuencia de recepción y al modo utilizando la llave M.I.N.
3. El sonido de entrada de datos normal se emite como un tren de impulsos.
4. Dar entrada a la frecuencia de transmisión y al modo.
5. El sonido cesa.
6. Presionar la llave M.CH. Se lleva a cabo la operación de frecuencia separada (la transmisión y recepción en frecuencias diferentes se programan en el CH 8).

NOTAS:
1. Diferentes modos y/o bandas también pueden programarse para transmisión y recepción.
2. Si la llave M.I.N. se presiona dos veces sucesivamente, esta memoria podrá utilizarse como una memoria ordinaria, teniendo ahora la misma frecuencia para la transmisión y la recepción.

● **Ricezione e trasmissione con il canale 8**

1. Portare l'interruttore M. CH in posizione 8.
2. Immagazzinare nella memoria la frequenza di ricezione ed il modo usando l'interruttore M. I.N.
3. L'avvenuta memorizzazione viene confermata da un tono bip. Impostare la frequenza e il modo di trasmissione.
4. Il tono bip si spegne.
5. Premere l'interruttore M. CH. Si ha così il funzionamento a frequenza sdoppiata (la frequenza di trasmissione è cioè diversa dalla frequenza di ricezione). Le due frequenze sono memorizzate nel canale 8.

NOTE:
1. È possibile programmare un modo e una banda diversi per la ricezione e la trasmissione.
2. Premendo l'interruttore M. I.N. due volte consecutive, questa memoria può anche essere usata come memoria normale, e cioè con la medesima frequenza per la trasmissione e la ricezione.

5.8 MOBILE OPERATION

Being compact in design, this transmitter is ideal for mobile operation. Satisfactory mobile operation is achieved through proper power and antenna connection, and thoughtful transceiver installation and adjustment.

5.8.1. TS-430S INSTALLATION

Secure the TS-430S under the dashboard using an optional MB-430 mounting bracket. As an alternative, use strapping, making sure that the TS-430S will not slip out of place while operating the vehicle.

NOTES:

1. Do not install the TS-430S near the heater outlet.
2. Allow sufficient space behind the TS-430S to ensure proper ventilation.

5.8.2. CONNECTING THE POWER CABLE

When connecting or disconnecting the power cable to or from the power connector, be sure that the power switch is always in the "OFF" position. Observe polarity of the cable. The TS-430S operates on 13.8V DC, negative ground. Battery polarity must be correct. The power cord is color coded:

POWER CABLE

CAUTION: Observe battery polarity.

Connect the TS-430S power cable to the battery terminals, with consideration to current requirements and noise prevention. The maximum current drawn by the TS-430S reaches between 18 and 20A when transmitting. Therefore, the cable should be made as short as possible, using the specified fuse. Also, determine that the power system of the car (including the battery and generator or alternator) will handle the increased load of the TS-430S.

Route battery and ANTENNA leads away from all high voltage secondary circuits to prevent ignition noise interference.

5.8.3. MOBILE ANTENNA

(1) Antenna Installation

Use a sturdy mount for the mobile antenna since HF antennas are larger (and have more wind load) and are heavier than VHF antennas. A bumper mount is recommended for general use. The ground side of the mount must be well grounded to the car body, since the body itself functions as the ground plane for the mobile antenna.

NOTES:

1. Some cars have plastic bumpers. For such cars, ground the antenna mount to the body.
2. When tuning a newly installed antenna, use the following procedure:

- Turn the CAR control fully counter-clockwise for minimum transmit power.
 - With the transceiver in transmit mode, raise transmit power output slowly by rotating the CAR control clockwise. The antenna should be adjusted with minimum power.
 - Transmitting with full power is recommended only after the antenna has been adjusted for a VSWR below 1.5:1.
3. Antenna installation is critical for successful mobile operation. For further information refer to THE RADIO AMATEUR'S HANDBOOK, RADIO HANDBOOK, or other texts.

(2) Coaxial Cable Connection

When the antenna is mounted on the vehicles bumper, the coaxial cable from the antenna can be routed through a drain hole in the trunk. When the antenna is roof mounted pass the cable between the body and door. Leave a drip-loop at the lowest point in the cable before entry into the vehicle to prevent water from entering the

(3) Antenna Adjustment

Some mobile antennas are not designed at 50-ohm impedance. In this case, impedance matching between the antenna and the coaxial cable (50Ω) is required. This can be achieved by using an antenna matching device or coupler.

The antenna to be used should first be checked with a dip meter to insure that it is designed for your operating band, then the impedance matching should be checked with an SWR meter.

The VSWR should preferably be less than 1.5:1 for satisfactory operation. For antenna adjustment refer to the antenna instruction manual.

5.8.4. NOISE REDUCTION

In motor vehicles, noise is generated by the ignition system. Other sources of noise include the wiper and heater motors.

Although the TS-430S is equipped with a noise blanker to minimize ignition noise, it is imperative that some preventive measures be taken to reduce the noise to the lowest possible level.

(1) Antenna location Selection

Since ignition noise is generated by the vehicles engine, the antenna must be installed as far from the engine as possible.

(2) Antenna Matching

In general, mobile antennas have a lower impedance than the 50-ohm coaxial cable used to feed them, resulting in a mismatch between the antenna and the coax. Such trouble can be eliminated by using an antenna tuner between the TS-430S and the coaxial cable.

(3) Bonding

The component parts of motor vehicles, such as the engine, transmission, muffler system, accelerator etc., are coupled to one another at DC

and low frequencies, but are isolated at high frequencies. By connecting these parts using heavy, braided ground straps, ignition noise can be reduced. This connection is called "bonding".

(4) Use Ignition Suppressor Cable or Suppressor Spark Plugs

Noise can be reduced by using spark plugs with internal resistors, or resistive suppressor ignition cable.

(5) Battery Power Connection

It is recommended that battery power be supplied directly to the TS-430S from the battery terminals.

CAUTION

Disconnect the TS-430S before jump-starting or before charging the battery.

(6) Battery Capacity

The power system of a motor vehicle is comprised of a battery and an alternator (which generates power while the engine is running) to supply current to loads or to charge the battery.

Since the transceiver draws high current during transmit, care should be exercised so the power system is not overloaded. When using the transceiver, the following points should be observed from the viewpoint of battery maintenance:

1. Turn the transceiver OFF when the lights, heater, wipers and other high-draw accessories are used.
2. Avoid transceiver operation when the engine is not running.
3. If necessary, use an ammeter and/or a voltmeter to check battery condition.

5.9 FIXED STATION OPERATION

5.9.1. Power

The TS-430S requires more than 18A at 13.8 VDC when transmitting full power. Use the model PS-430 power supply for fixed stations.

5.9.2. ANTENNAS

For HF fixed-station operation, an antenna specifically designed for amateur operation is recommended. Antenna types include wire antennas, verticals, rotary beams, and other antenna types. HF antennas are quite large and must be installed to withstand strong wind, heavy rain, etc.

Any antenna used with the TS-430S should be of 50-ohm impedance and should be connected using an appropriate coaxial cable such as RG-8/U. Impedance matching is important. Impedance mismatching will result in a high VSWR and power loss, or can cause unwanted harmonic radiation and interference (TVI, BCI).

The impedance match can be checked with an SWR meter. Generally, satisfactory operation is assured when the VSWR (Voltage Standing Wave Ratio) is less than 1.5:1.

A rotary beam antenna is very effective for DX operation in the 14, 21 and 28 MHz bands. (Fig. 5-11)

NOTE:

Protect your equipment – use a lightning arrestor.

5.8 MOBILBETRIEB

Dank seiner kompakten Abmessungen ist der TS-430S geradezu prädestiniert für den Mobilbetrieb. Bei vor-schriftsmäßiger Einbau in das Fahrzeug und genauer Beachtung der Anschlussanweisungen für Antenne und Stromversorgung ist ein einwand-freier Betrieb des TS-430S gewährleistet.

5.8.1 Einbau des TS-430S in ein Kraftfahrzeug

Der Transceiver wird mit Hilfe der als Sonderzubehör erhältlichen Mobil-

AM filter detail No. 1

Schritt 1 beim Einbau des A3E-Filters
 Détail no. 1 du filtre AM
 Filtro de AM, detalle No. 1
 Dettaglio n. 1 del filtro AM

① = AM FILTER
 A3E-FILTER
 FILTRE AM
 FILTRO DE AM
 FILTRO AM

② = Cut here
 Hier durchtrennen
 oder auslösen
 Couper ici
 Cortar aquí
 Tagliare qui

Ⓐ = Control unit
 Steuerungs-
 Baugruppe
 Unité de commande
 Unidad de comando
 Unità di comando

Fig. 6-1
 Abb. 6-1

AM filter installation No. 3

AM-Filter installation No. 3
 Installation filtre AM No. 3
 Instalación del filtro de AM No. 3
 Montaggio del filtro AM, n. 3

① = Cut here
 Hier durchtrennen oder auslösen
 Couper ici
 Cortar aquí
 Tagliare qui

② = Loosen
 Lösen
 Desserrer
 Allentare

IC 4
 R1-4
 C195
 R202

Fig. 6-3
 Abb. 6-3

AM filter Detail No. 2

Schritt 2 beim Einbau des A3E-Filters
 Détail no. 2 du filtre AM
 Filtro de AM, detalle No. 2
 Dettaglio n. 2 del filtro AM

① = Cut here
 Hier durchtrennen oder auslösen
 Couper ici
 Cortar aquí
 Tagliare qui

② = Move
 Umhängen
 Déplacer
 Mover
 Muovere

YK-88C
 YK-88CN
 YK-88SN
 SSB FILTER YK-88S
 YK-88A

Fig. 6-2
 Abb. 6-2

TS-430S Internal Wiring

Beschaltung der Fornschat-Buchse (REMOTE)
 Câblage interne du TS-430S

① = Not used
 Nicht beschaltet
 Pas utilisé
 No se utiliza
 Non usato

② = From STBY switch
 (PTT circuit for foot
 switch)
 Vom PTT-Schalter
 (z.B. Fußschalter)
 A partir du commutateur
 STBY (Circuit PTT pour
 interrupteur à pédale)
 De la lave STBY (circuit
 PTT para la llave de pie)
 Dall' interruttore STBY
 (circuit PTT per
 interruttore a piede)

③ = GND
 Masse
 MASSE
 TIERRA
 MASSA A TERRA

④ = ALC input
 ALC-Eingang
 Entrada ALC
 Ingresso ALC

⑤ = Speaker output
 Lautsprecher Ausgang
 Sortie du haut-parleur
 Salida del altavoz
 Uscita altoparlante

⑥ = Relay common
 Mittenkontakt Relais
 Relais commun
 Relè comune

⑦ normally connected
 Ruhezustand des Relais
 Normalmente conectado
 Normalmente abierto
 Collegamento normale

⑧ normally open
 Arbeitskontakt des Relais
 Normalmente abierto
 Aperto in modo normale

to be continued: forges. suite: ritnuarâ: Continue:

Fig. 6-4
 Abb. 6-4

6.1 INSTALLING THE OPTIONAL FILTERS

1. Remove the power connector from the radio.
2. Using a #2 philips screwdriver, remove the top cover (8 screw). Be careful of the VOX controls, and the speaker lead, which may be plugged.
3. Loosen the two side screws and remove the 2 screws securing the IF unit bracket. Swing the bracket up slightly to access and remove the two heat sink screws. Swing the assembly down.
4. Remove 7 screws from the IF unit. Switch the board forward. Protect the top of the front panel from scratching.
5. Using a 45W (or less) soldering pencil, clear the 6 holes for the filter, if they are filled with solder. When installing an AM filter, first remove R16 on the IF unit, and cut the 129 lead on the Control unit.
6. There is no polarity to the filter. Install the filter into its position on the IF unit. Solder the 2 mounting tabs, and the 4 input and output pins to the circuit board. Solder sparingly, and heat the connections only long enough to insure a good solder joint. Don't overheat the filter or circuit board.
7. Carefully inspect your soldering. Be certain that all pins are actually soldered, and that you have not soldered across any spots on the board or between any of the pins on the filter. Clip the pins flush to be board.
8. Replace the IF unit in its place. Make certain no wires will be pinched underneath the board. Replace the 2 heat sink screws for the board, plus the 2 screws for the board, then the 2 side screws and replace the 2 rear bracket screws. (See that the wire harness does not interfere with the PG scan speed control).
9. Move the connection as illustrated when an AM filter is installed.
10. Reconnect the speaker lead, and reinstall the top cover.

11. Apply power and verify your work. Filter installation is now complete.

6.2 HOW THE TX FINAL TRANSISTORS ARE PROTECTED

Final transistor protection is provided by sampling the reflected power. As the reflected power is increased (higher SWR) transmitter drive is reduced, thus decreasing input to the final transistors. This in turn reduces collector loss, protecting the final transistors.

6.3 OPTIONAL 10HZ DISPLAY RESOLUTION

If you would like 10Hz instead of the supplied 100 Hz display resolution, cut the jumper as shown on the Control unit.

6.4 OPERATION WITH A LINEAR AMPLIFIER

Operation with a linear amplifier. TS-430S internal wiring. Pin 6 ALC input Connector Metal Shell is Ground Pin 2, Relay Common Pin 4, Relay N.O. Use shielded line for both AL and RL (control line). Initial linear amplifier tune-up should be performed with the exciter 50% power, to reduce wear-and-tear on both the linear, and the exciter. Use of a dummy load is strongly suggested, since the bands are already sufficiently crowd. The TS-430S may be operated with any conventional linear amplifier which will accept up to approximately 100 watts RF drive, has a low current DC operated keying circuit and returns approximately -8 ~ -10V DC ALC (adjustable) back to the exciter.

6.1 EINBAU DER ZUSATZ-QUARZFILTER

(Diese Arbeiten sollten zweckmäßig-erweise dem Kenwood-Amateurfunk-Vertragshändler überlassen bzw. nur von erfahrenen Funkamateuren selbst durchgeführt werden!)

1. Steckverbinder des Gleichstromversorgungsabteils an der Rückwand abklemmen.
2. Die acht Befestigungsschrauben für den Gehäusedeckel mit einem passenden Kreuzschlitzschraubendreher Größe 2 herausdrehen und den Deckel abnehmen.
3. Dabei darauf achten, daß die drei VOX-Regler und der SPEED-Regler nicht beschädigt und das Verbindungskabel des Lautsprechers nicht abgerissen werden.
4. Die beiden seitlichen Schrauben und die beiden Schrauben, mit denen der Zf-Teil am Chassis befestigt ist, herausdrehen. Das Chassis etwas nach oben klappen, dann die beiden Befestigungsschrauben für den Kühlkörper entfernen. Das Chassis wieder nach unten klappen.
5. Die sieben Befestigungsschrauben des Zf-Teils herausdrehen. Dabei darauf achten, daß die Oberkante der Frontplatte nicht verkratzt wird.
6. Die beim Tauchlöten evtl. ver-schlossenen sechs Durchstecköffnungen für die Kontaktstifte und Befestigungslaschen für die Quarzfilter mit einem 30-45 Watt-Lötkeißen und einem Lötlötlösungsmittel (A3E-Quarzlot) zunächst R16 aus der Zf-Leiterplatte austreten

(siehe Abb. 6-2). Danach den einen Anschlussdraht des Widerstandes R129 auf der Steuerungs-Leiterplatte (Control unit) durchtrennen (siehe Abb. 6-1) oder besser den ganzen Widerstand austreten.

8. Da die Zusatz-Quarzfilter ungepolt sind, ist ihre Einbaulage belanglos. Die vier Kontaktstifte und zwei Befestigungslaschen von oben her in die freigelegten Bohrungen der Zf-Leiterplatte einführen, das Filter fest gegen die Platte drücken und zuerst die Laschen, dann die Kontaktstifte mit den zugehörigen Leiterbahnen auf der Folien-seite verlöten. Diese Lötarbeiten so zügig wie möglich durchführen und die Lötstellen nicht zu stark erhitzen, da das Quarzfilter sonst unbrauchbar wird und sich die Leiterbahnen von der Platine ablösen können.
7. Die Zf-Leiterplatte nochmals auf einwandfreie Beschaffenheit aller Lötstellen überprüfen. Dabei darauf achten, daß keine „Lötlötbrücken“ zwischen den dicht benachbarten Leiterbahnen entstanden sind, die unbedingt entfernt werden müssen. Die überstehenden Enden der Kontaktstifte dicht an der Leiterplatte abschneiden.
8. Die Zf-Leiterplatte nun wieder im Chassis einbauen, dabei darauf achten, daß keine Anschlußdrähte auf der Unterseite der Platte eingeklemmt werden. Die 7 Schrauben, mit denen die Platte am Chassis befestigt ist, die beiden Befestigungsschrauben für den Kühlkörper, die beiden seitlichen und die beiden hinteren Schrauben anbringen und festziehen. Auch dabei darauf achten, daß der Kabelbaum nicht zwischen Chassis und Kühlkörper bzw. der Baugruppe mit den VOX-Reglern eingeklemmt wird.
9. Wenn das A3E-Filter YK-88A (6 KHz) eingebaut wurde, die Drahtbrücke auf der Zf-Leiterplatte wie auf Fig. 6-2 gezeigt, von Punkt S nach Punkt A umlöten.
10. Das Lautsprecherkabel wieder

anschließen und den Gehäusedeckel montieren.

11. Den Transceiver mit dem Netzteil verbinden, einschalten und auf einwandfreie Funktion überprüfen. Der Einbau der Zusatz-Quarzfilter ist damit beendet.

6.2 WIRKUNGSWEISE DER SENDE-ENDESTUFEN-SCHUTZSCHALTUNG

Zum Schutz der kostspieligen Leistungsstrahler der Sender-Endstufe wird die reflektierte Leistung durch eine Sensorschaltung fortlaufend gemessen. Steigt die reflektierte Leistung bei zunehmenden SWW ebenfalls an, reduziert die Schutzschaltung die an die Endstufen-Transistoren gelangende Treiberleistung so stark, daß die Transistoren nicht mehr mit der höchstzulässigen Kollektor-Verlustleistung arbeiten, so daß Schäden durch Überlastung ausgeschlossen sind. Diese Schutzschaltung darf jedoch nicht ständig oder über längere Zeit beansprucht werden, da sie nicht für Dauerbetrieb konstruiert ist, sondern einen Schutz gegen zufällige Schäden bieten soll.

6.3 WAHLWEISE UMSTELLUNG DER DIGITAL-FREQUENZANZEIGE AUF 10 HZ AUFLÖSUNG.

(Diese Arbeiten sollten zweckmäßig-erweise dem Kenwood-Amateurfunk-Vertragshändler überlassen bzw. nur von erfahrenen Funkamateuren selbst durchgeführt werden!)

Falls anstelle der serienmäßigen Auflösung der letzten Digital-Anzeigestelle von ± 100 Hz eine Auflösung von ± 10 Hz gewünscht wird, die Drahtbrücke zwischen R144 und R202 auf der Steuer-Leiterplatte (X53-1290-00) durchtrennen (siehe Fig. 6-4) oder besser auslöten.

6.5 ACC CONNECTOR DATA/ZUBEHÖR-ANSCHLÜßBUCHSE (ACC)/DONNEES DU CONNECTEUR ACC/DATOS DEL CONECTOR ACC/
 DATI PER IL COLLEGAMENTO ACC

ACC connector output/Verknüpfungstabellen (Logikzustände am Ausgang ACC)/
 Sortie du connecteur ACC/Salida del conector ACC/Uscita conettore ACC

[MHz]	(A) [MHz]	(B) [MHz]	No. 2 BD	No. 4 BC	No. 1 BB	No. 7 BA	No. 5 WRC
0.15 ~ 0.4999	0.15 ~ 1.5999	0.15 ~ 1.5999	0	0	0	0	1
0.5 ~ 1.5999	1.6 ~ 1.9999	1.6 ~ 1.9999	0	0	0	1	0
1.6 ~ 2.4999	2.0 ~ 2.9999	2.0 ~ 2.9999	0	0	1	0	1
2.5 ~ 3.9999	3.0 ~ 3.9999	3.0 ~ 3.9999	0	0	1	1	0
4.0 ~ 6.4999	4.0 ~ 6.8999	4.0 ~ 6.8999	0	1	0	0	1
6.5 ~ 7.4999	6.9 ~ 7.4999	6.9 ~ 7.4999	0	1	0	1	0
7.5 ~ 10.4999	7.5 ~ 13.8999	7.5 ~ 13.8999	0	1	1	0	1
10.5 ~ 15.9999	13.9 ~ 14.9999	13.9 ~ 14.9999	0	1	1	1	0
16.0 ~ 22.9999	15.0 ~ 20.8999	15.0 ~ 20.8999	1	0	0	0	1
23.0 ~ 29.9999	20.9 ~ 21.9999	20.9 ~ 21.9999	1	0	0	0	0
	27.9 ~ 29.9999	27.9 ~ 29.9999					0

(A) = Frequency band
 Frequenzbereich
 Banda de frecuencia
 Banda de frecuencia
 Banda frecuencia

(B) = PIN No.
 Kontakt Nr.
 No. de BROCHE
 No. de CLAVIJA
 Spillo n.

Note: Band output data is TTL level.
 0 - Low
 1 - High

Remarque: Les données de sortie de bande correspondent au niveau TTL.
 0 - Basse
 1 - Haute

Hinweis: Bandausgang hat TTL-Pegel.
 0 - Niedrig
 1 - Hoch

Nota: Los datos de la salida de banda son para el nivel TTL.
 0 - Bajo
 1 - Alto

Fig. 6-5
 Abb. 6-5

ACC connector wiring
 Beschaltung der ACC-Buchse
 Cablage du connecteur ACC
 Cablingo del conector ACC
 Cabiaggio conettore ACC

Note: TPD: Grounding this terminal reduces transmission output to approx. 50W.

Hinweis: TPD: Durch Verbinden des Stiftes mit Masse geht die Sendeleistung um etwa 50W zurück (QRP-Betrieb).

Remarque: TPD: La mise à la terre de cette borne réduit la sortie de la transmission sur environ 50W.

X VTR Connector
 Transverter-Buchse
 Conector X VTR
 Conettore X VTR

(A) = RF UNIT
 HF-Baugruppe
 Unità RF
 Unidade RF

(B) = RF Output (Transmit)
 Treiber-Ausgang (Sendung)
 Sortie RF (Transmission)
 Salida de RF (Transmisión)
 Uscita RF (Trasmisione)

(C) = To Transverter
 ON-OFF SW
 Zum Transverter
 EIN-AUS-Schalter (nach Masse)
 Vers la convertisseur
 ON-OFF SW
 Al Transvertidor
 LLAVE DE ENCENDIDO Y APAGADO
 All interruptore
 ON-OFF del transverter

(D) = Relay Control
 (+1.2V ON transmit)
 Relaisumschaltung
 (+1.2V = bei Sendung)
 Comande de relais
 (Transmisión +1.2V ON)
 Control de relé
 (+1.2V en transmisión)
 Comando relé
 (transmissione ON+1.2V)

(E) = RF Input From Transverter (RECEIVE)
 Empfänger-Ausgang vom Transverter
 Entrée RF à partir du convertisseur (RECEPTION)
 Entrada de RF del transvertidor (RECEPCION)
 Ingresso RF del transverter (ricezione)

(F) = From Transverter ALC
 ALC-Steuersignal vom Transverter
 A partir du convertisseur ALC
 Del ALC Del transvertidor
 Del Transverter ALC

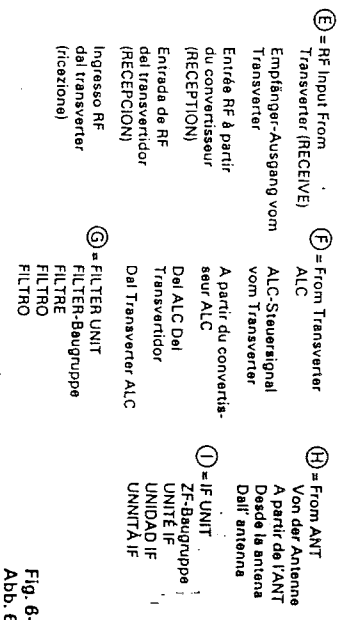

Fig. 6-7
 Abb. 6-7

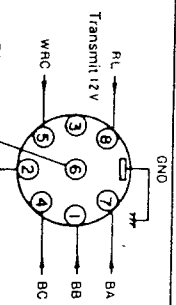
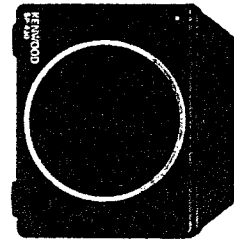

Fig. 6-6
 Abb. 6-6

Note: TPD: Poniendo a tierra este terminal se reduce la salida de transmisión a 50W aproximadamente.
 Nota: TPD: Collegando a terra questo terminale si riduce l'uscita di trasmissione a circa 50W.

SP-430



PS-430

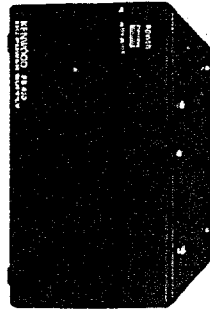

HS-5

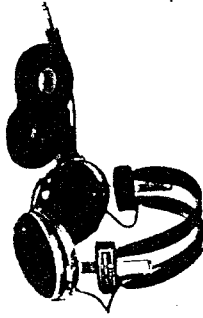

HS-6

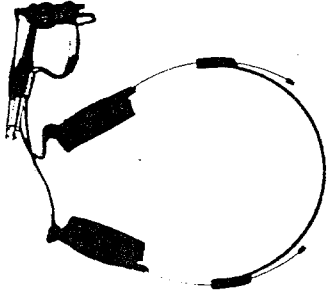

MC-60A

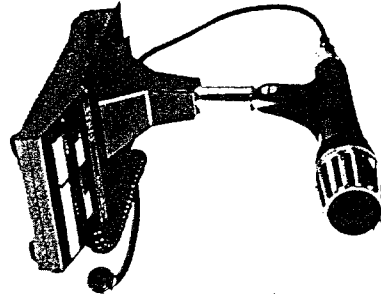

HC-10

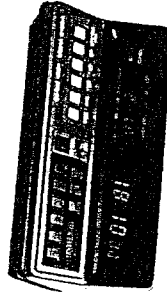

MB-430

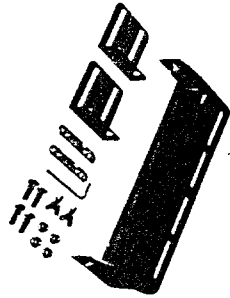

YK-88A

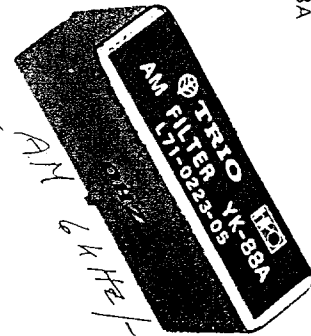

YK-88C

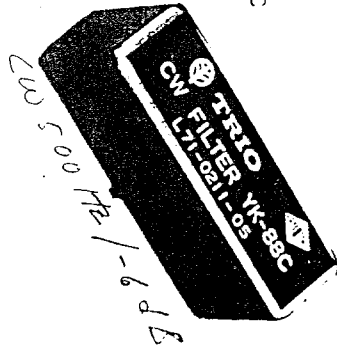

YK-88SN

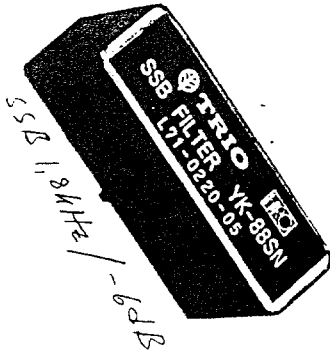

YK-88CN

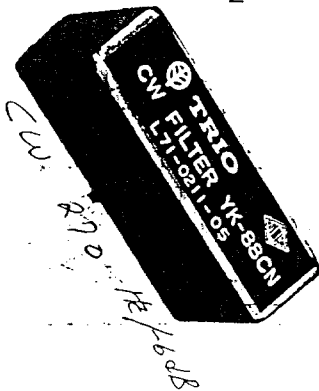

AT-130

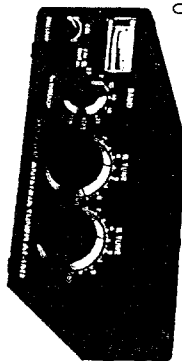

AT-250

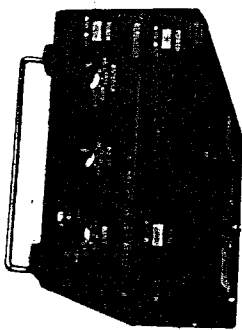



● BLOCK DIAGRAM ● BLOCKSCHALTBILD ● SCHEMA DE PRINCIPLE ● DIAGRAMA EN BLOQUES ● SCHEMA A BLOCCHI

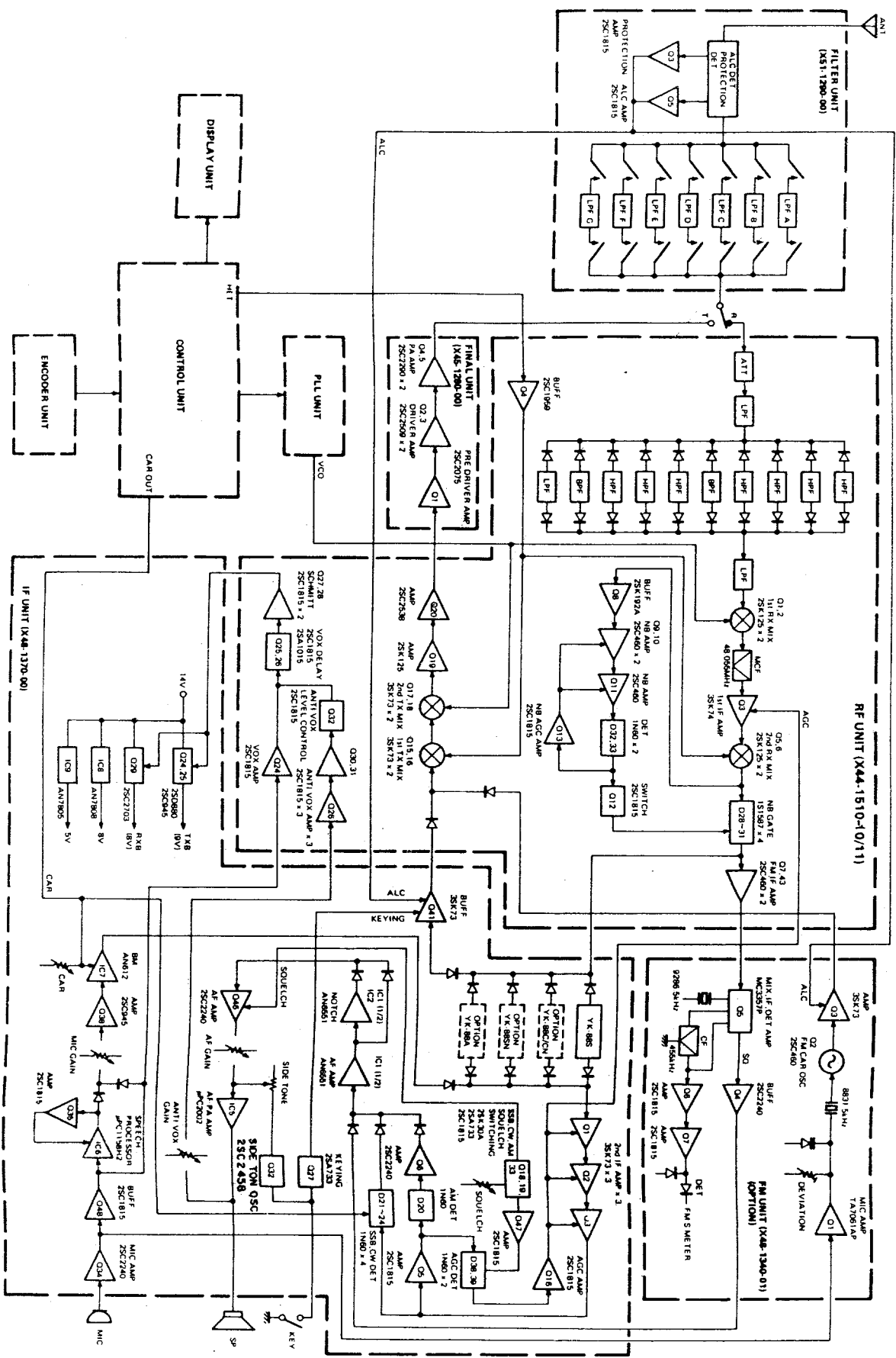

PLL UNIT (X50-1910-00)

PLL UNIT (X50-1910-00)

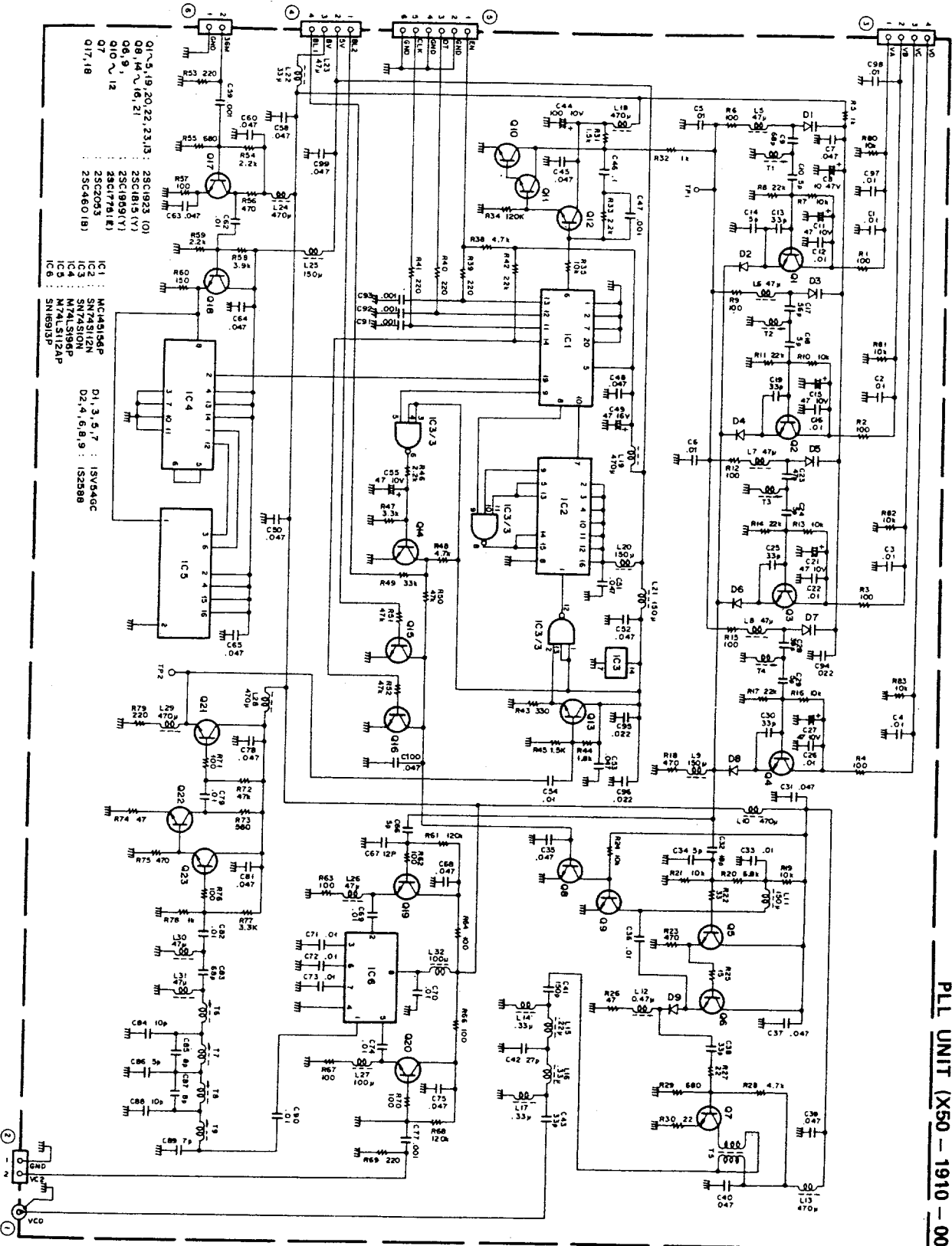

FM-430 (オーディオ)

FM UNIT (X48-1340-01)

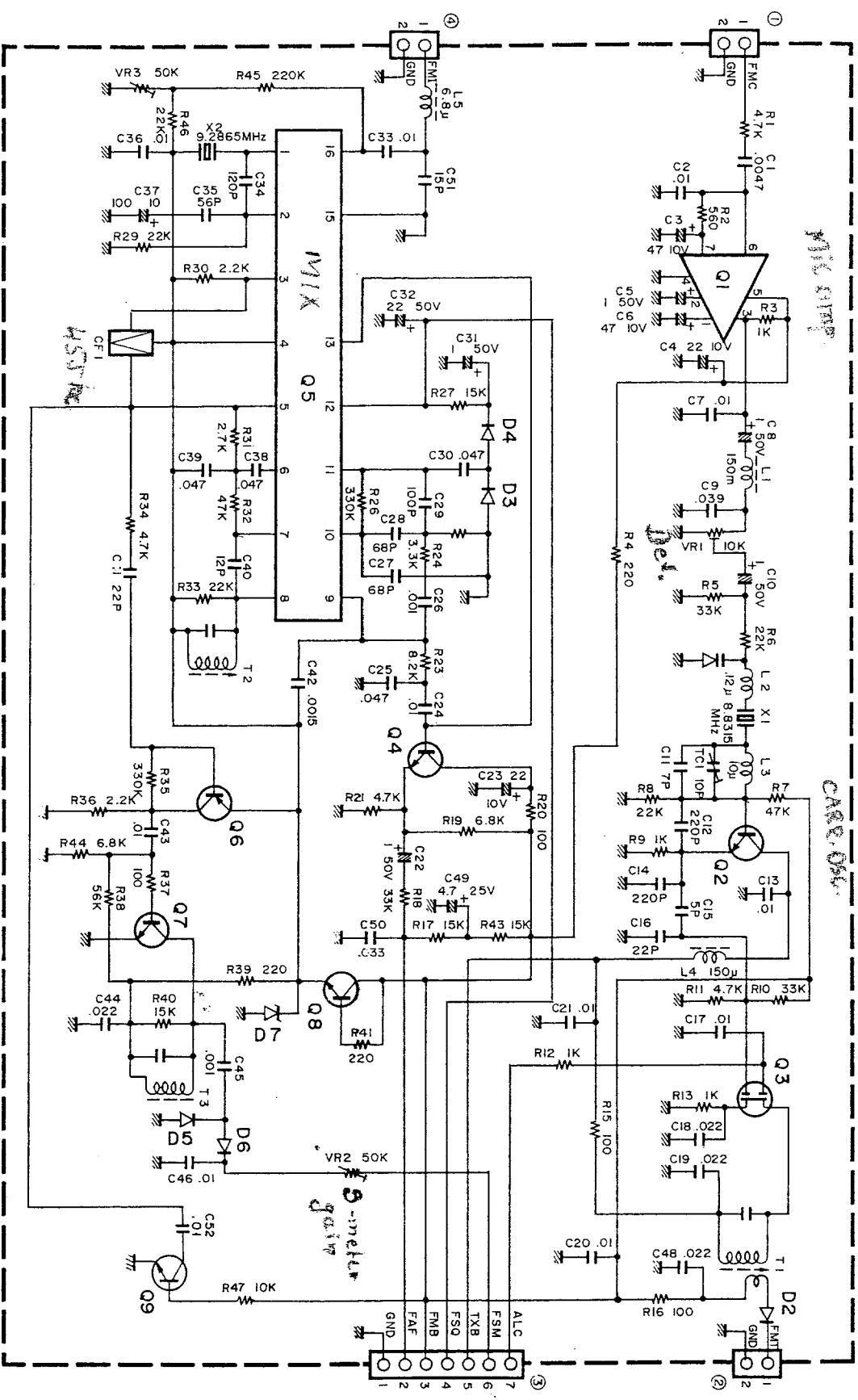

- Q1 : TAT061AP
- Q2 : 2SC4601(B)
- Q3 : 3SK73(GR)
- Q4 : 2SC2240(GR)
- Q5 : MC3357P
- Q6 : 2SA1015(Y)
- Q7~9 : 2SC1815(Y)
- D1 : IS2208
- D2 : IS1555
- D3~6 : IN60
- D7 : WZ071

RF UNIT (X44-1510-00)

変更内容 (L70, L71の追加, C104 100P→47P, L12, T13, C104接続変更)
 インダクタンス記入なし, C200追加

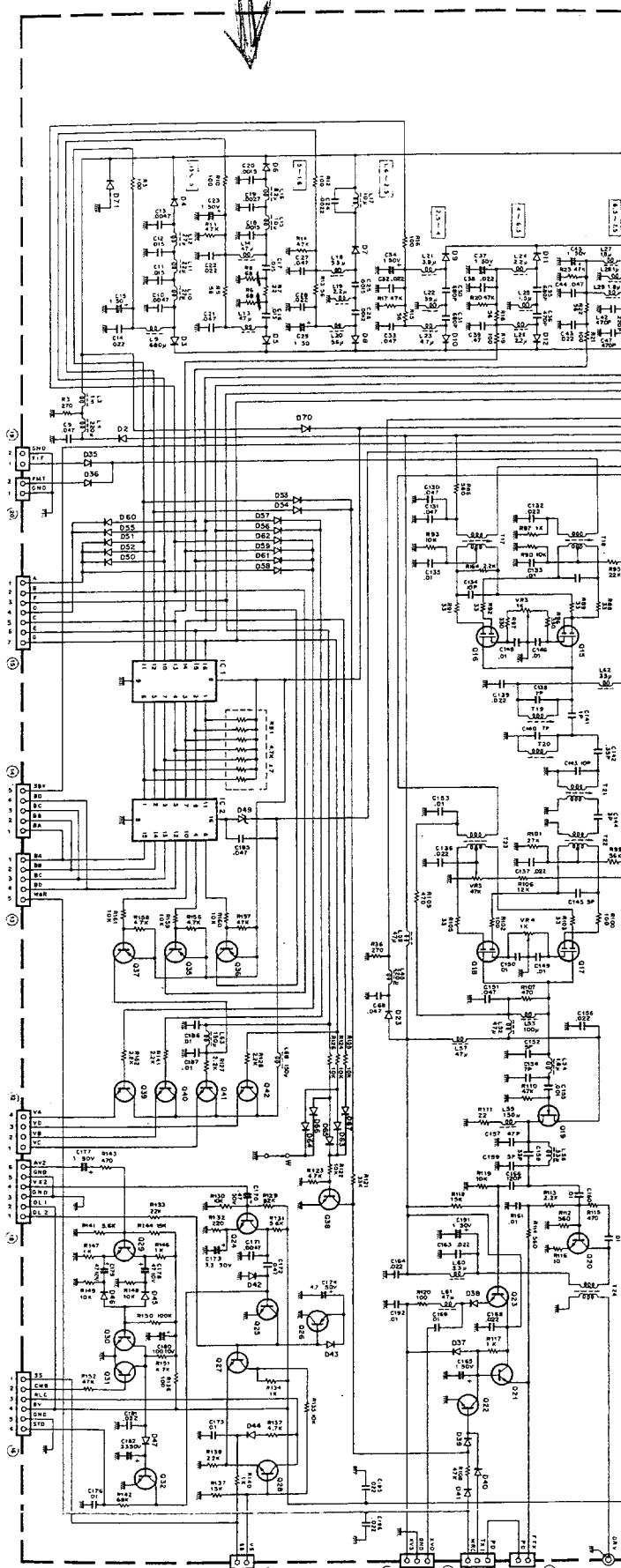
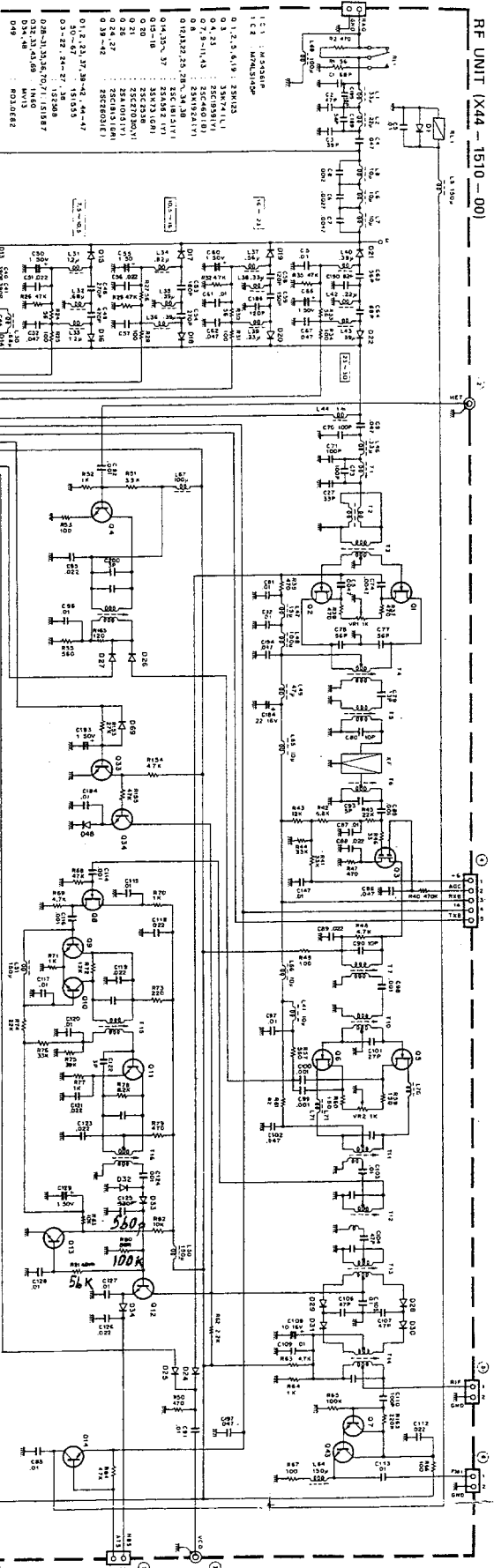

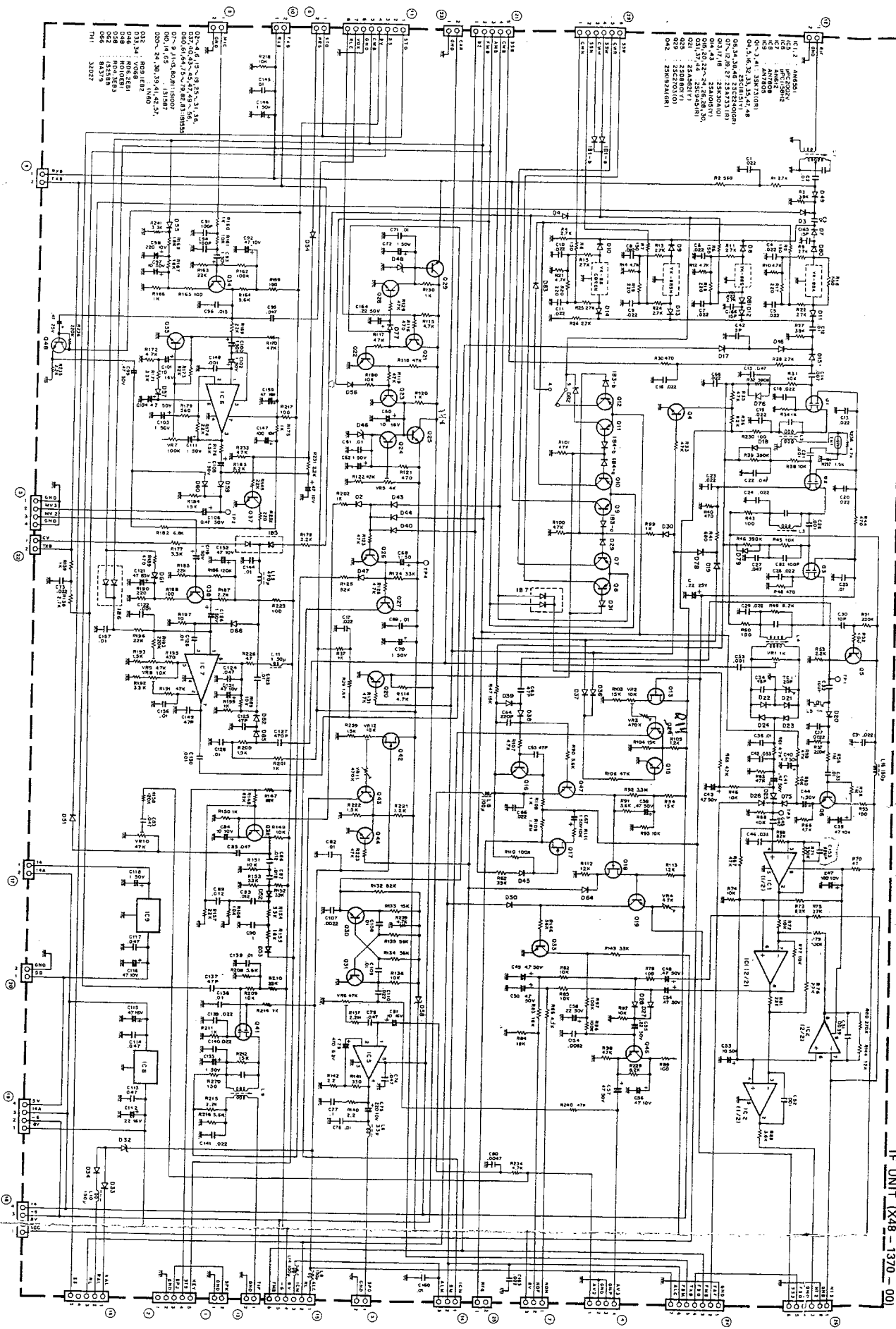

Free Manuals Download Website

<http://myh66.com>

<http://usermanuals.us>

<http://www.somanuals.com>

<http://www.4manuals.cc>

<http://www.manual-lib.com>

<http://www.404manual.com>

<http://www.luxmanual.com>

<http://aubethermostatmanual.com>

Golf course search by state

<http://golfingnear.com>

Email search by domain

<http://emailbydomain.com>

Auto manuals search

<http://auto.somanuals.com>

TV manuals search

<http://tv.somanuals.com>