

KETTLE

Montageanleitung „ERGORACE“
Art.-Nr. 07988-880

deutsch
english
française
nederlands
español
italiano
polski
čeština



MADE IN GERMANY

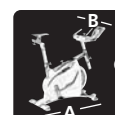

A	120 cm
B	53 cm
C	120 cm
	56 kg

	max. 130 kg
--	----------------

Assembly Instructions

Before assembling or using the exercise cycle, please read the following instructions carefully. They contain important information for use and maintenance of the equipment as well as for your personal safety. Keep these instructions in a safe place for maintenance purposes or for ordering spare parts.

For Your Safety

- **⚠ ATTENTION!** The crosstrainer should be used only for its intended purpose, i.e. for physical exercise by adult people.
- **⚠ ATTENTION!** Any other use of the equipment is prohibited and may be dangerous. The manufacturer cannot be held liable for damage or injury caused by improper use of the equipment.
- Exercise has been designed in accordance with the latest standards of safety. Any features which may have been a possible cause of injury have been avoided or made as safe as possible.
- Incorrect repairs and structural modifications (e.g. removal or replacement of original parts) may endanger the safety of the user.
- Damaged components may endanger your safety or reduce the lifetime of the equipment. For this reason, worn or damaged parts should be replaced immediately and the equipment taken out of use until this has been done. Use only original KETTLER spare parts.
- If the equipment is in regular use, check all its components thoroughly every 1 -2 months. Pay particular attention to the tightness of bolts and nuts. This applies especially to the securing bolts for saddle and handlebars.
- To ensure that the safety level is kept to the highest possible standard, determined by its construction, this product should be serviced regularly (once a year) by specialist retailers.
- **⚠ ATTENTION!** Instruct people using the equipment (in particular children) on possible sources of danger during exercising.
- The device requires a supply voltage of 230V, 50 Hz. Connect the power cord with a grounded protective contact socket.
- **⚠ IMPORTANT!** Do not under any circumstances carry out electrical repairs or alterations yourself. Always ensure that such work is done by a properly qualified electrician.
- **⚠ IMPORTANT!** disconnect the apparatus from the mains before doing repair, maintenance or cleaning work.
- Do not use a multiple power socket for the running belt. If an extension cable is being used, ensure that it complies with the VDE regulations.
- Unplug the power cord of the device from the socket if not used for a longer period.
- Ensure that the power cable is not pinched and that no-one can trip over it.
- All electric appliances emit electromagnetic radiation when in operation. Please do not leave especially radiation-intensive appliances (e.g. mobile telephones) directly next to the cockpit or the electronic control system as otherwise values displayed might be distorted (e.g. pulse measurement).
- Before beginning your program of exercise, consult your doctor to ensure that you are fit enough to use the equipment. **Base your program of exercise on the advice given by your doctor. Incorrect or excessive exercise may damage your health!**
- **Any interference with parts of the product that are not described within the manual may cause damage, or endanger the person using this machine. Extensive repairs must only be carried out by KETTLER service staff or qualified personnel trained by KETTLER.**
- Always observe the general safety rules and precautions for working with electrical equipment.
- **⚠ ATTENTION!** Before beginning your program of training, study the instructions for training carefully.
- Our products are subject to a constant innovative quality assurance. We reserve the right to perform technical modifications.
- In case of enquiry, please contact your KETTLER dealer.
- In choosing the location of the apparatus, ensure a sufficient safety distance from any obstacles. The apparatus must not be mounted in the immediate vicinity of main passageways (paths, doorways, corridors).
- For a comfortable training position please adjust the handlebar and saddle position to your body height.
- **⚠ Caution:** While assembly of the product keep off children's reach (Choking hazard - contains small parts).
- **⚠ WARNING! Heart rate monitoring systems can be imprecise. Excessive training may lead to serious health damage or death. If you feel giddy or weak, please stop the training immediately.**
- **⚠ ATTENTION!** If you lose the pulse signal, the performance of the device will remain constant for approx. 60 seconds and is then slowly adjusted downwards. Please check your pulse measuring system (ear clip, hand pulse or chest belt) so that the pulse signal of the electronics can be entered again.

Handling the equipment

- Before using the equipment for exercise, check carefully to ensure that it has been correctly assembled.
- It is not recommended to use or store the apparatus in a damp room as this may cause it to rust. **Please ensure that no part of the machine comes in contact with liquids (drinks, perspiration etc.). This may cause corrosion.**
- The machine is designed for use by adults and children should not be allowed to play with it. Children at play behave unpredictably and dangerous situations may occur for which the manufacturer cannot be held liable. If, in spite of this, children are allowed to use the equipment, ensure that they are instructed in its proper use and supervised accordingly.
- The exercise cycle complies with the DIN EN 957 - 1/- 5 class HA.
- Before beginning your first training session, familiarize yourself thoroughly with all the functions and settings of the unit.
- A slight production of noise at the bearing of the centrifugal mass is due to the construction and has no negative effect upon operation. Possibly occurring noise during reverse pedalling result from engineering and are absolutely safe.
- The exercise cycle has a electromagnetic brake system.
- The equipment is independent of revolutions per minute.
- **Please ensure that liquids or perspiration never enter the machine or the electronics.**
- Before use, always check all screws and plug-in connections as well as respective safety devices fit correctly.
- Always wear suitable shoes when using.

- Use for your regular cleaning, maintenance and care our appliance maintenance set (Article no. 07921-000) specifically licensed for KETTLER Sports apparatus and available from the Sport specialized trade..

- Nobody may be in the moving range of a training person during training.

Instructions for Assembly

- Ensure that you have received all the parts required (see check list) and that they are undamaged. Should you have any cause for complaint, please contact your KETTLER dealer.
- Before assembling the equipment, study the drawings carefully and carry out the operations in the order shown by the diagrams. The correct sequence is given in capital letters.
- The equipment must be assembled with due care by an adult person. If in doubt call upon the help of a second person, if possible technically talented.
- Please note that there is **always** a danger of injury when working with tools or doing manual work. Therefore please be careful when assembling this machine.
- Ensure that your working area is free of possible sources of danger, for example don't leave any tools lying around. Always dispose packaging material in such a way that it may not cause any

danger. There is always a **risk of suffocation** if children play with plastic bags!

- The fastening material required for each assembly step is shown in the diagram inset. Use the fastening material exactly as instructed. The required tools are supplied with the equipment.
- Bolt all the parts together loosely at first, and check that they have been assembled correctly. Tighten the locknuts by hand until resistance is felt, **then use spanner to finally tighten nuts completely against resistance (locking device)**. Then check that all screw connections have been tightened firmly. **Attention:** once locknuts have been unscrewed they no longer function correctly (the locking device is destroyed), and must be replaced.
- For technical reasons, we reserve the right to carry out preliminary assembly work (e.g. addition of tubing plugs).

List of spare parts page 28-30

When ordering spare parts, always state the full article number, spare-partnumber, the quantity required and the S/N of the product (see handling).

Example order: Art.no.07988-880 / spare-part no. 10100030 / 2 pieces / S/N

Please keep original packaging of this article, so that it may be used for transport at a later date, if necessary.

Goods may **only** be returned after prior arrangement and in (internal) packaging, which is safe for transportation, in the original box if possible.

It is important to provide a detailed defect description / damage report!

Important: spare part prices do not include fastening material; if fastening material (bolts, nuts, washers etc.) is required, this should be clearly stated on the order by adding the words „**with fastening material**“.

Waste Disposal



KETTLER products are recyclable. At the end of its useful life please dispose of this article correctly and safely (local refuse sites).

KETTLER (GB) Ltd.

Merse Road · North Moons Moat · Redditch, Worcestershire B98 9HL · Great Britain

<http://www.kettler.co.uk>

KETTLER International Inc.

1355 London Bridge Road · Virginia Beach · Virginia VA 23453 USA





<http://www.kettlerusa.com>

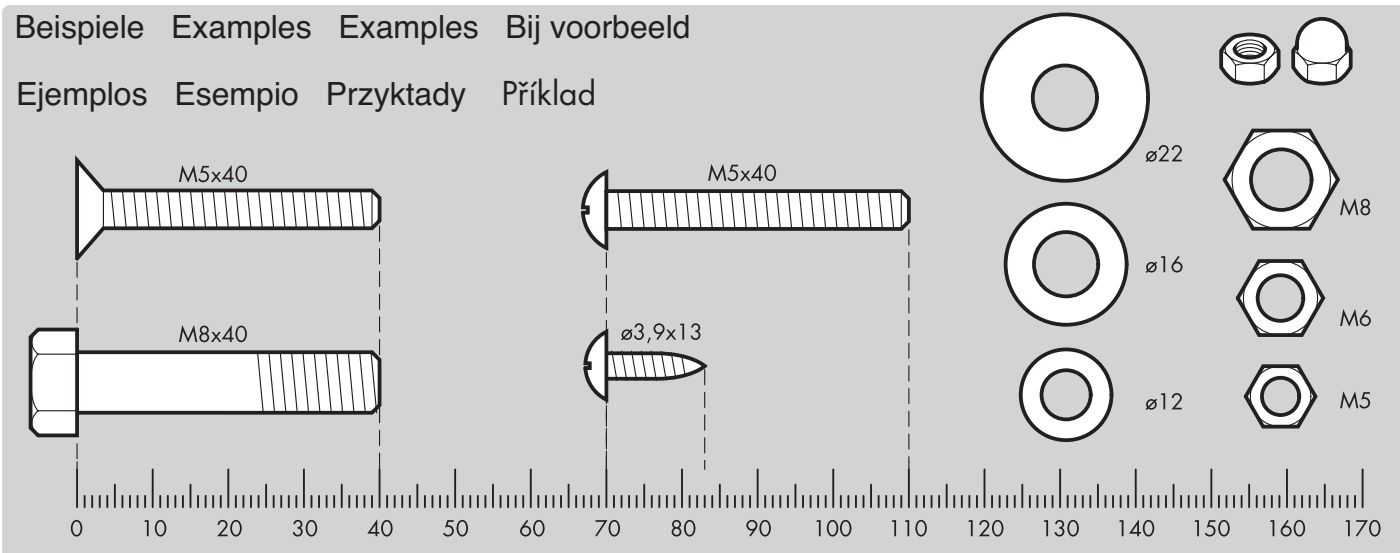



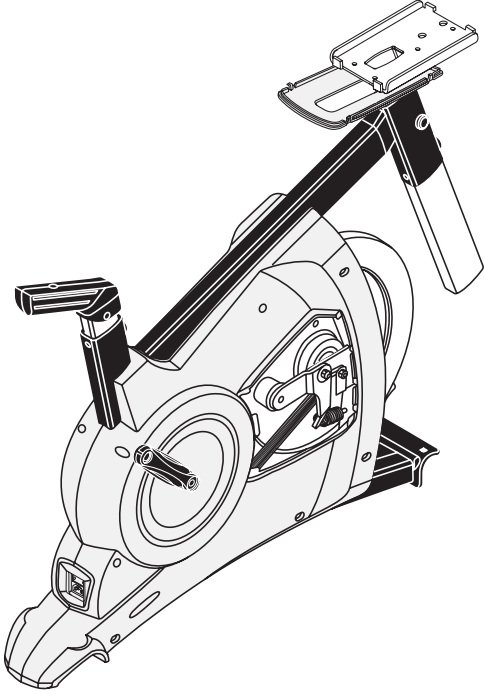
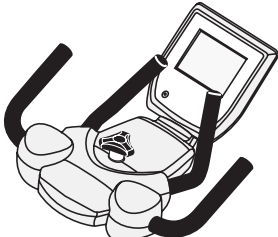
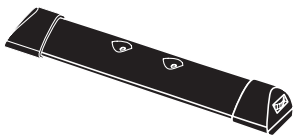
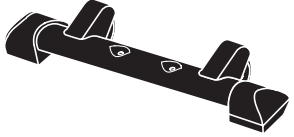



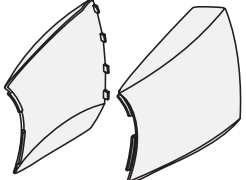

Messhilfe für Verschraubungsmaterial

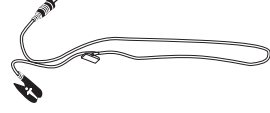
- GB - Measuring help for screw connections
- F - Gabarit pour système de serrage
- NL - Meethulp voor schroefmateriaal
- E - Referencia de medición para el material de atornilladura
- I - Misura per il materiale di avvitamento
- PL - Wzornik do połączeń śrubowych
- CZ - Měřicí pomůcka pro materiál k přišroubování

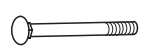

Checkliste

	1	
	1	
	1	
	1	
	2	
	1	
	1/1	
	1/1	

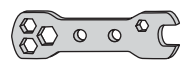
	1	
	1	
	1	
 M 6 x 20	6	
 Ø 6,4x12,5x1,6	6	
 M 8 x 60	2	
 M 8 x 60	2	
 M 8 x 65	1	
 Ø 21x8,25x2	1	
 M 8	2	
 Ø 8,3x16x2	4	
 M 8	1	
	1	

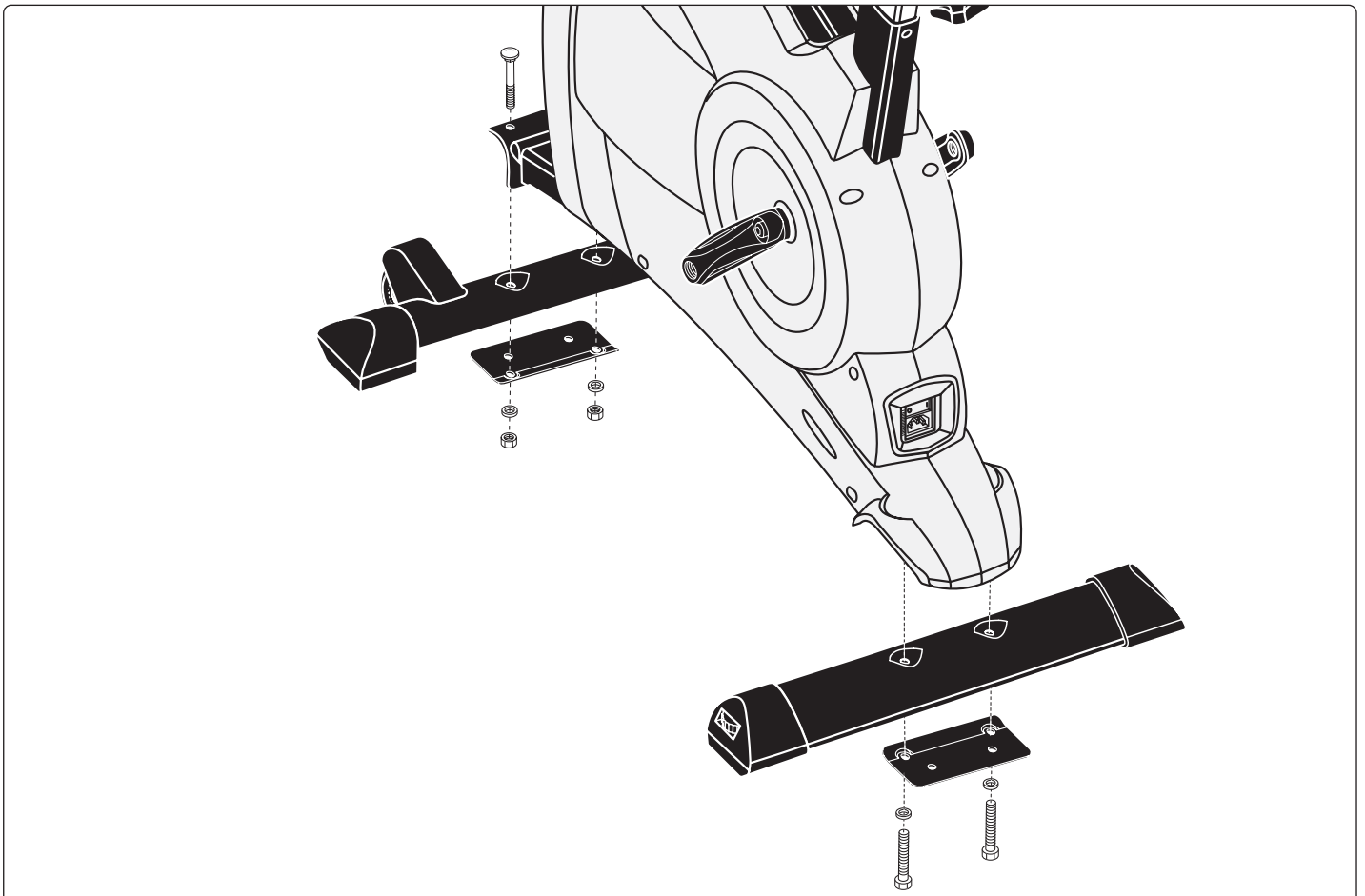
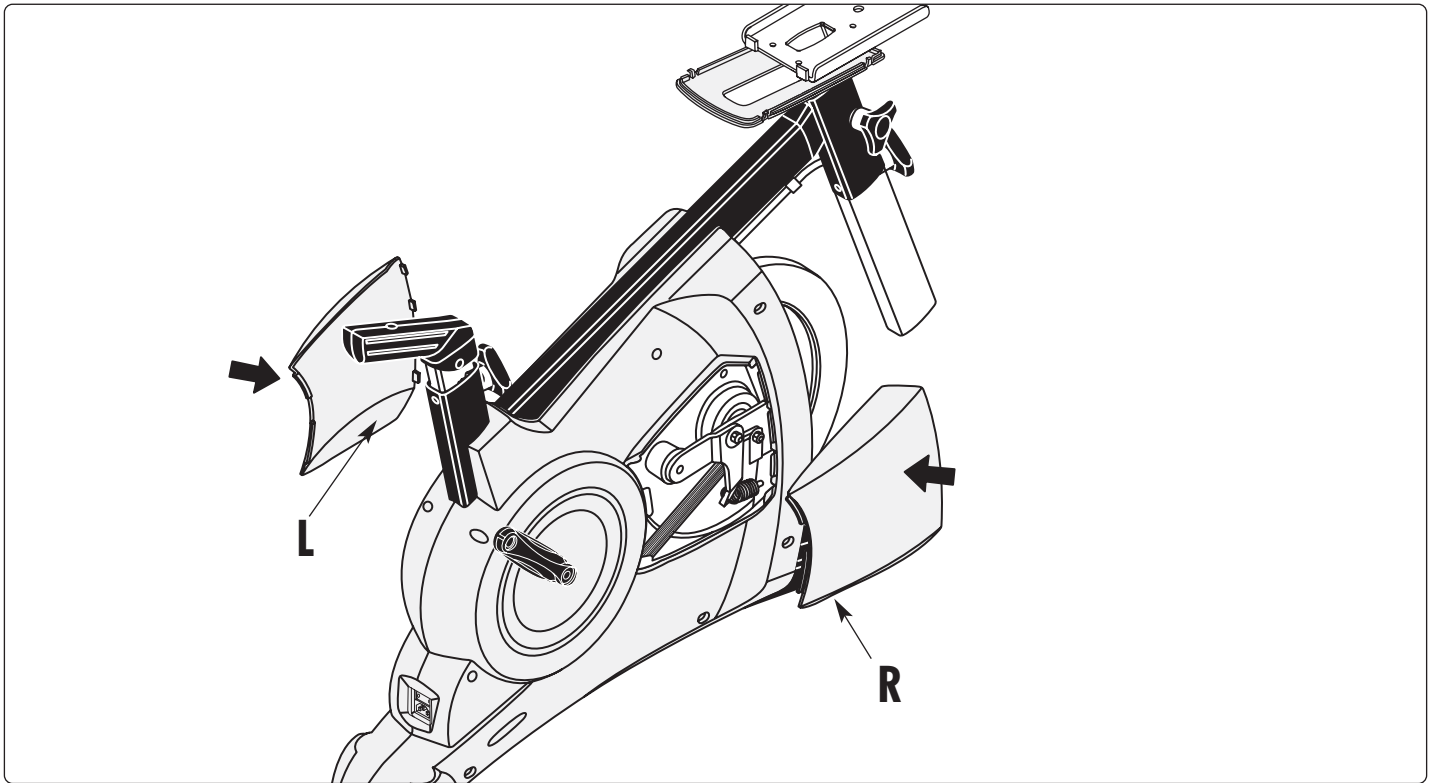

 M 8 x 60

 Ø 8, 3 x 16 x 2

 M 8 x 60

 Ø 8, 3 x 16 x 2

 M 8

3

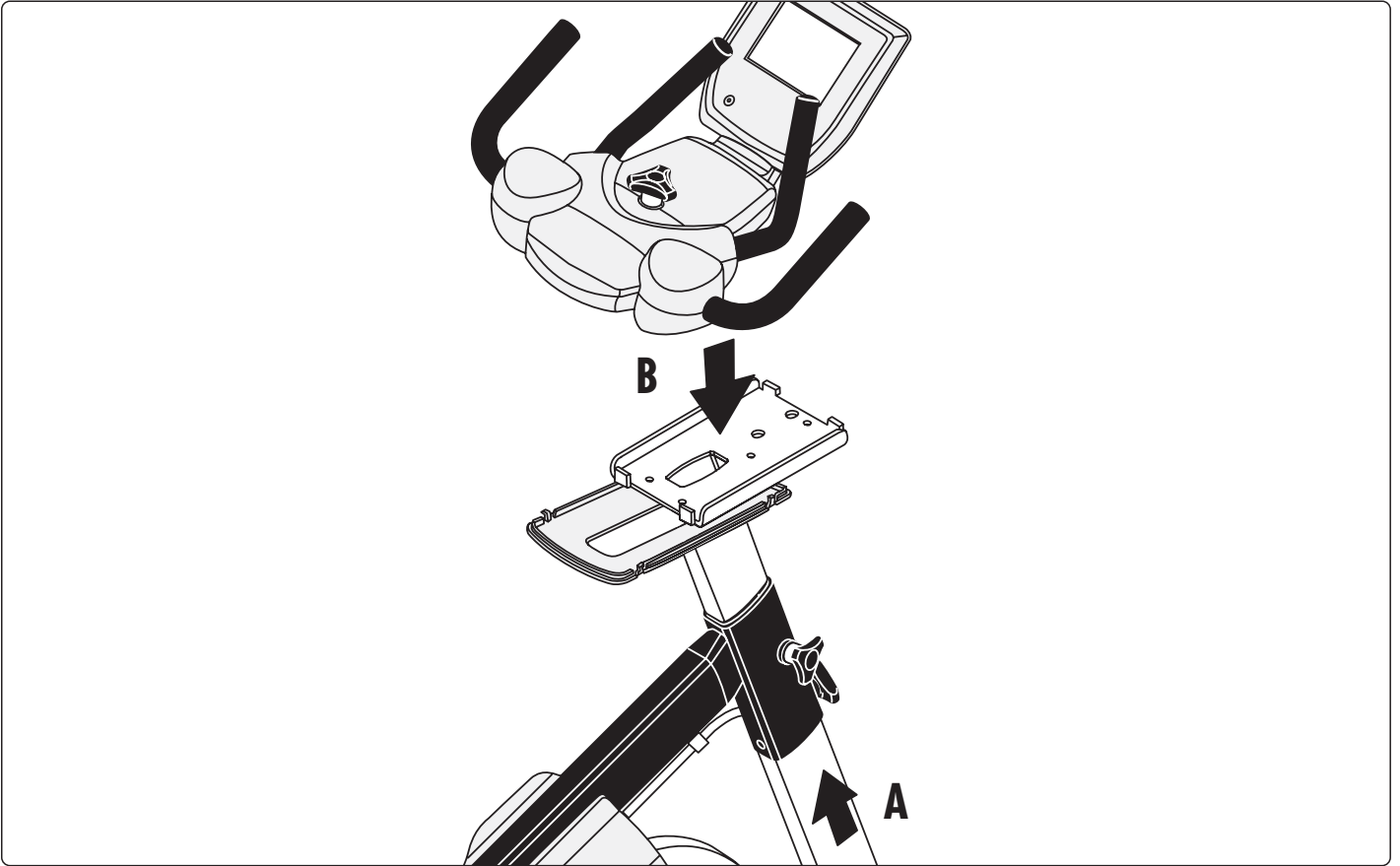

4

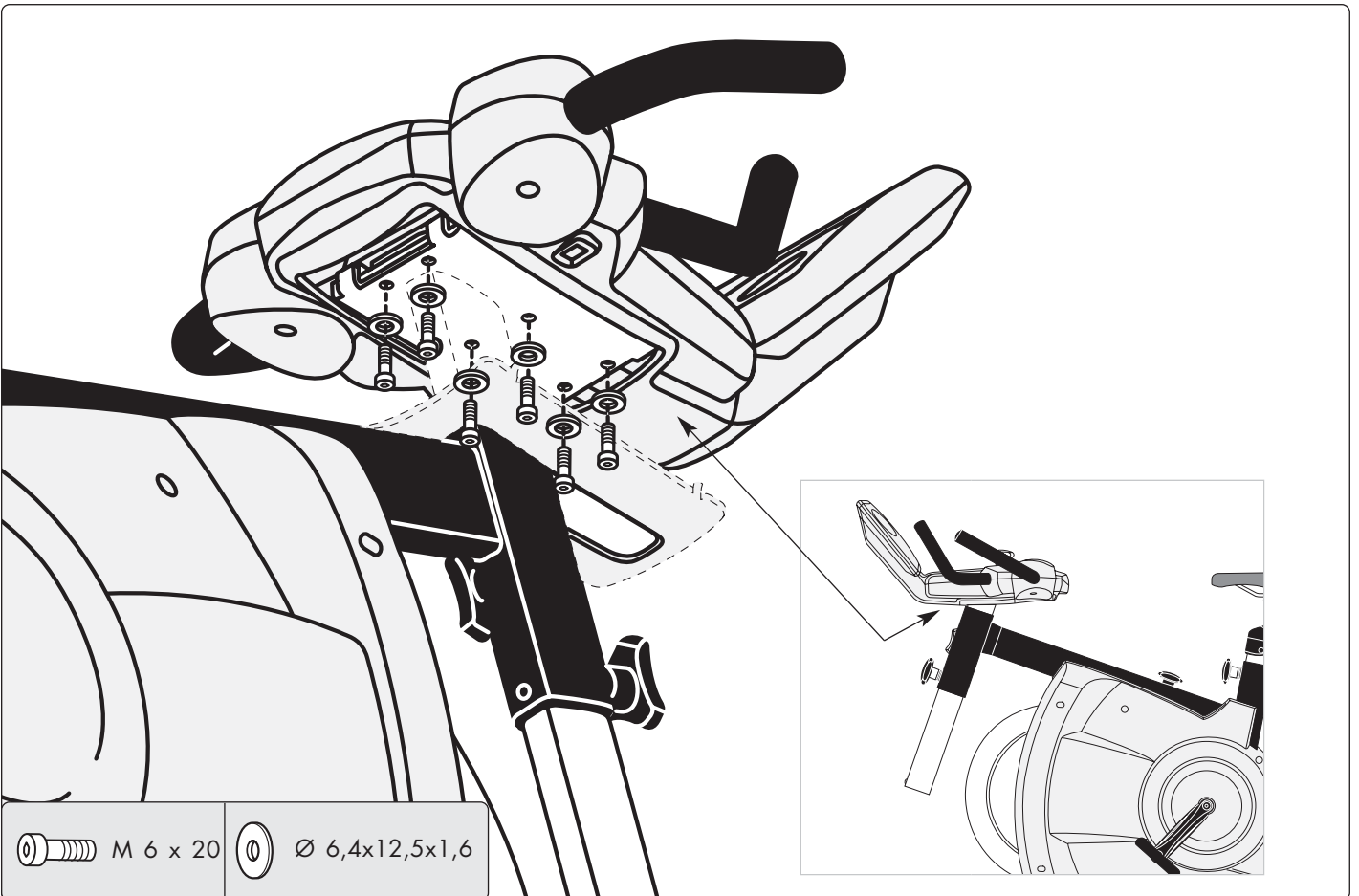

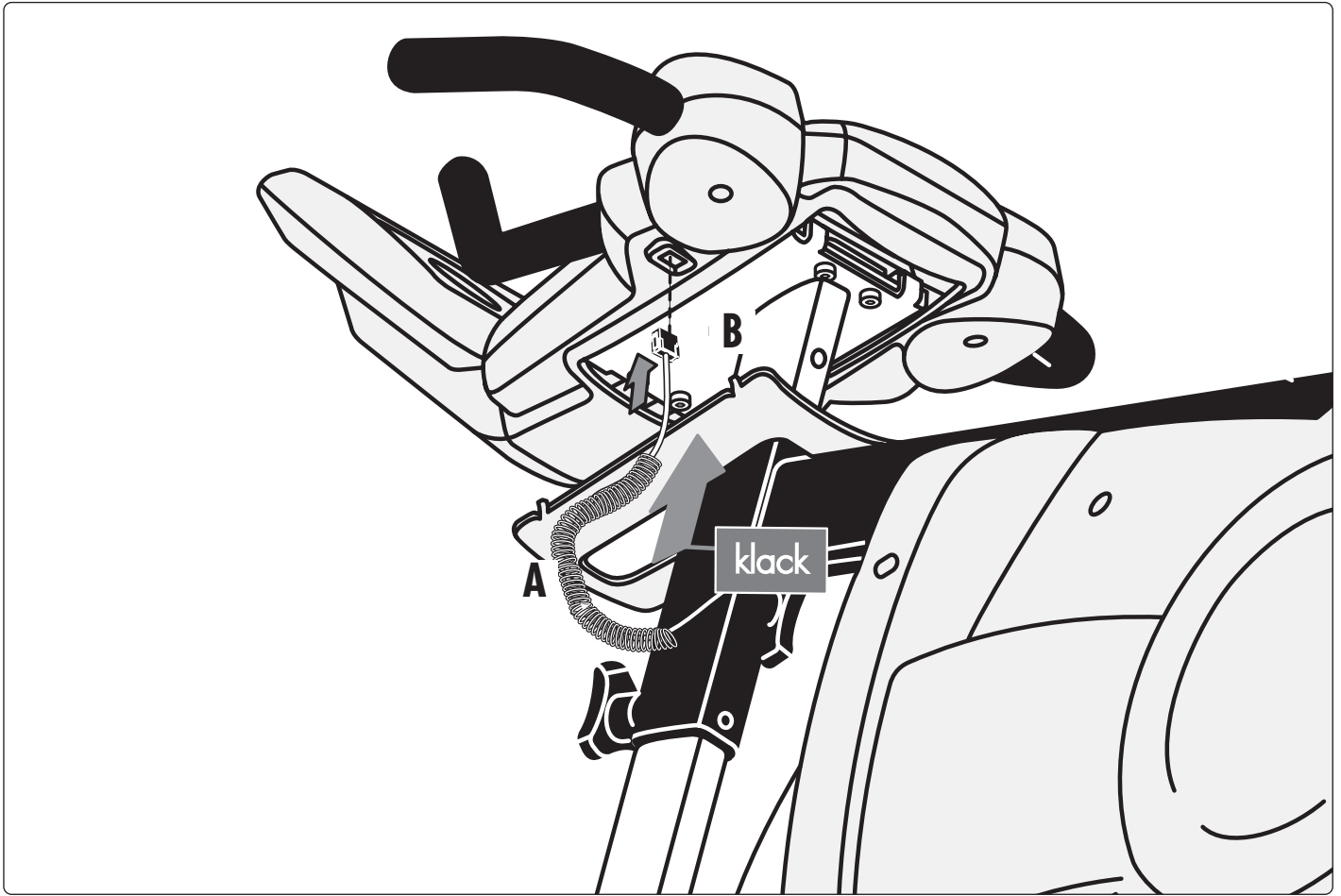

6

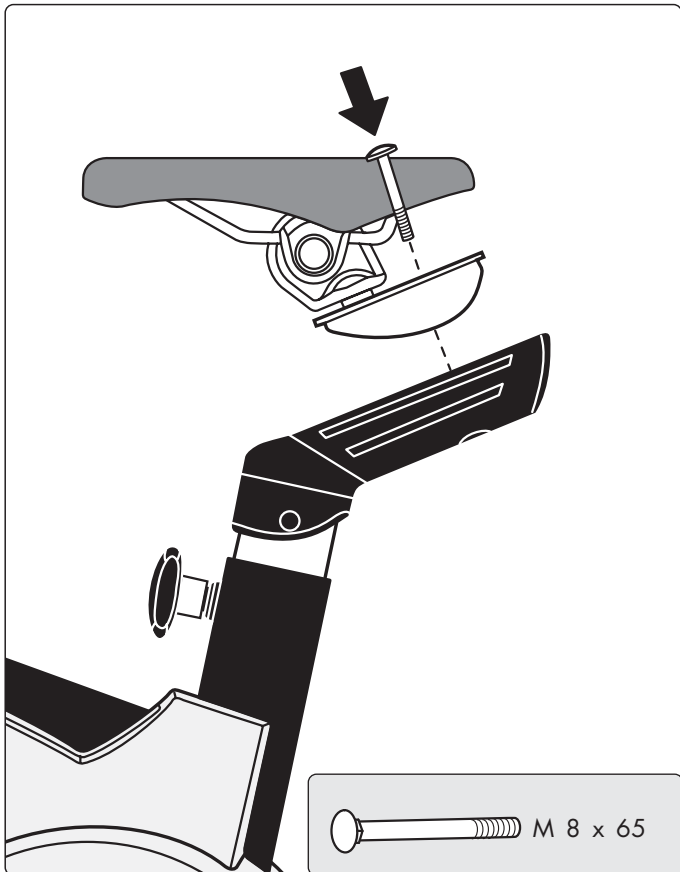

7

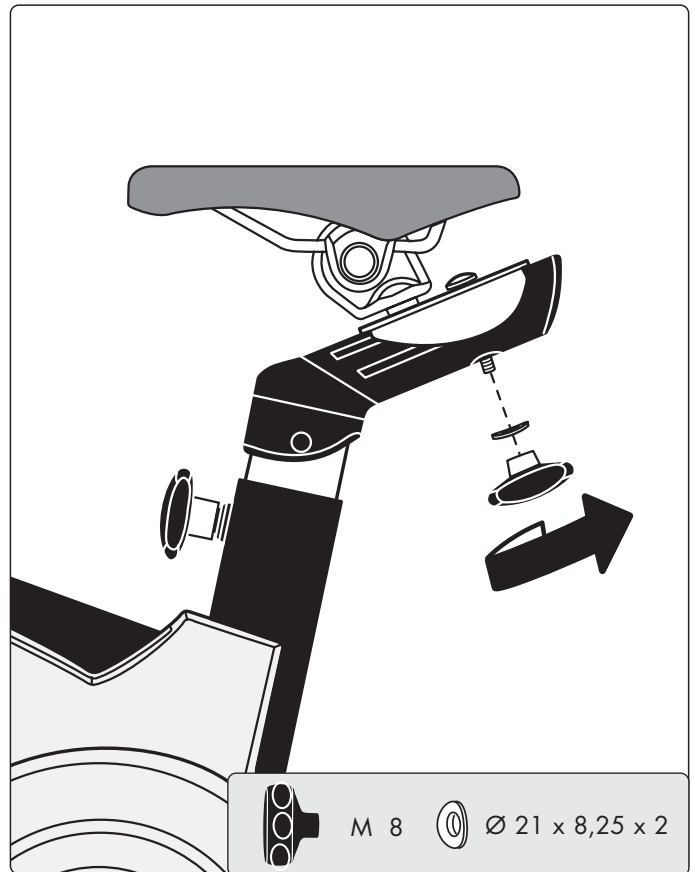

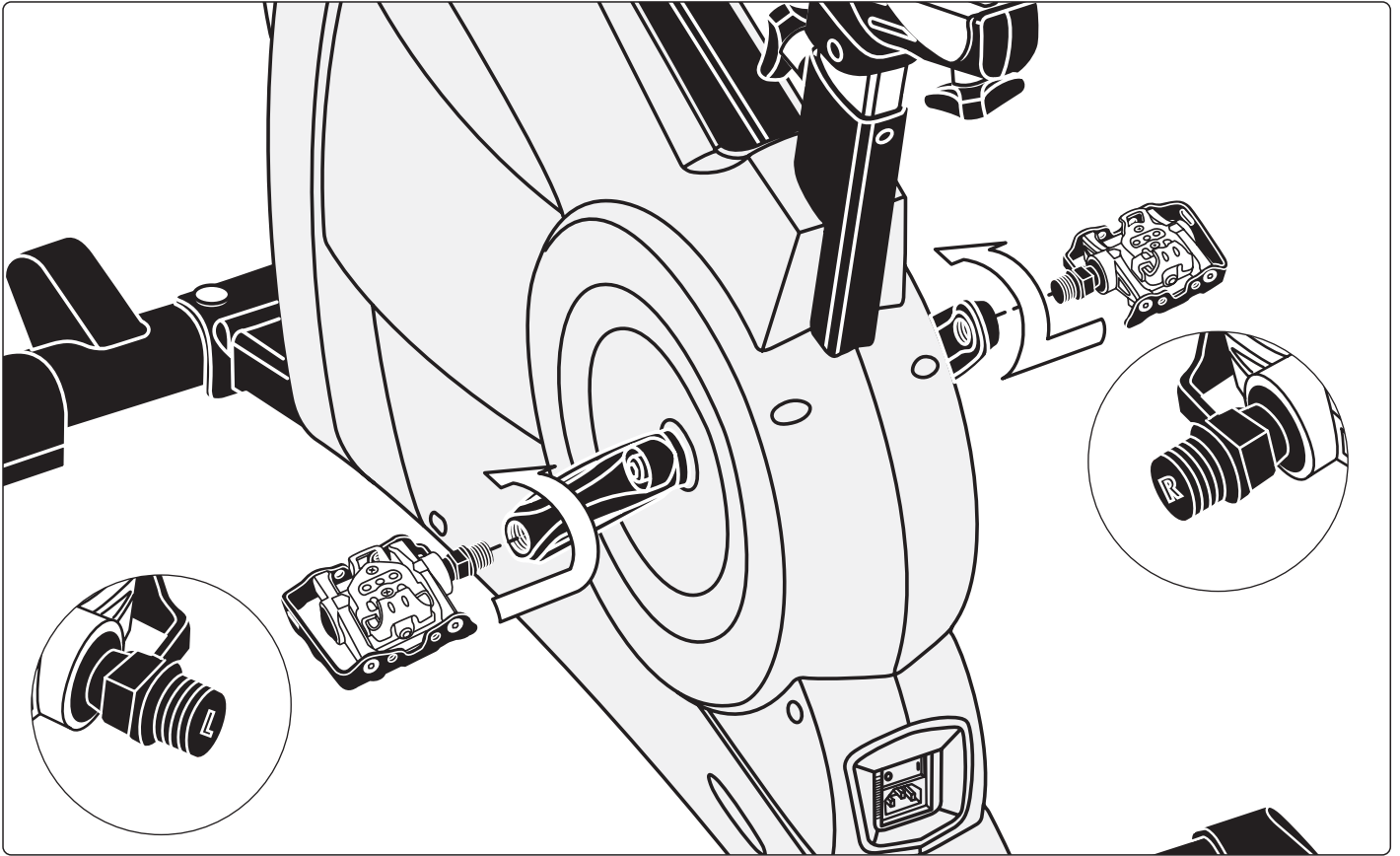

Handhabunashinweise

- gb - Handling - f - Indications relatives à la manipulation - nl - Bedieningsinstructies - e - Instrucciones de manejo
 - i - Avvertenze per il maneggio - pl - Wskazówki obsługowe - cz - Pokyny k manipulaci

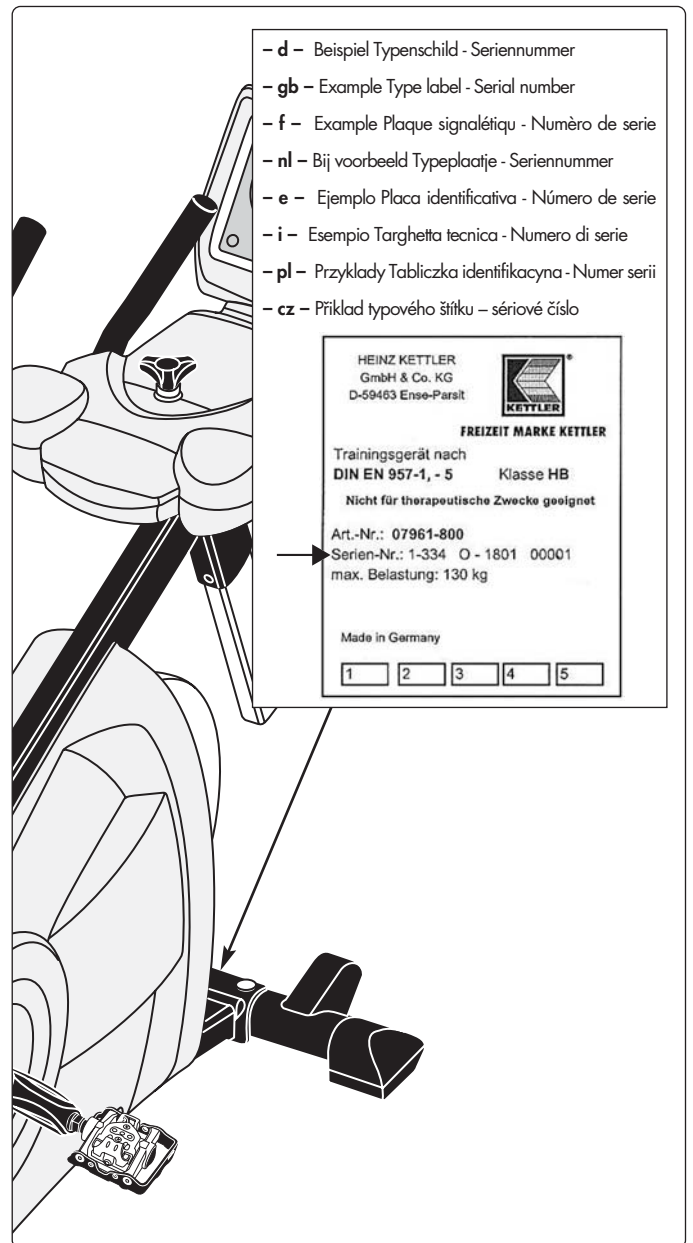
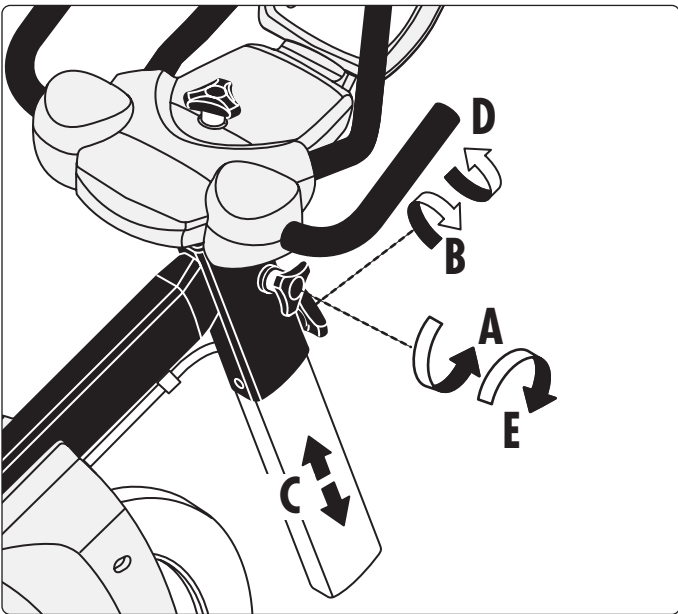
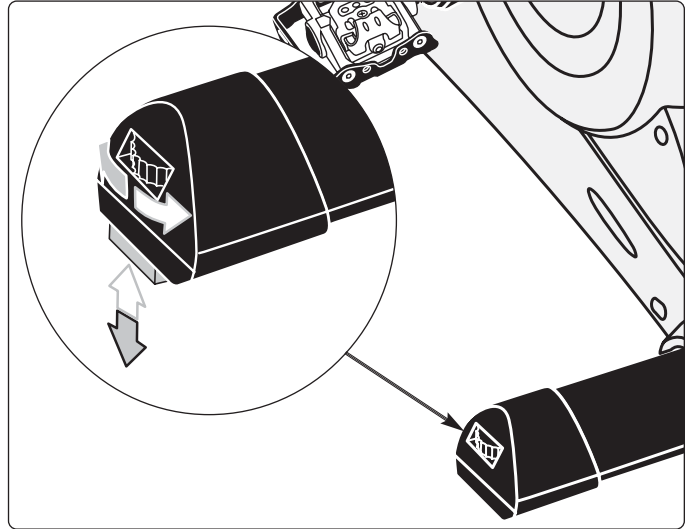
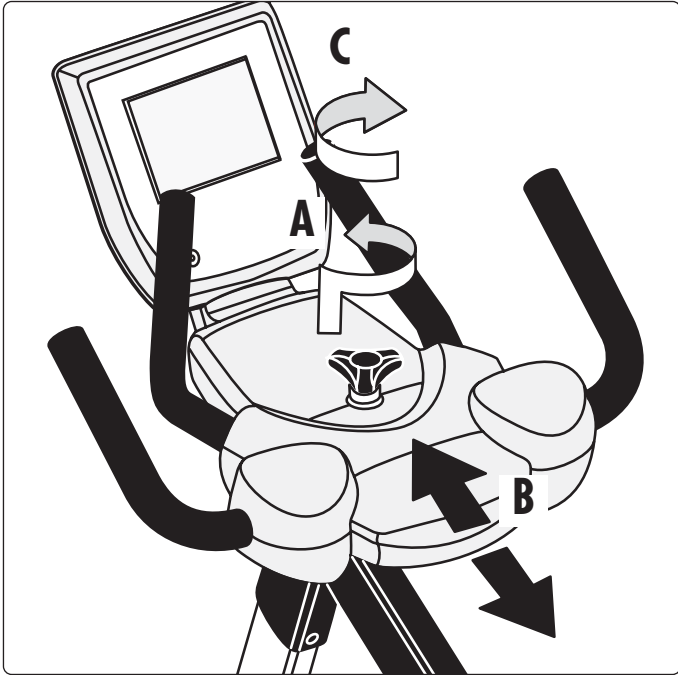

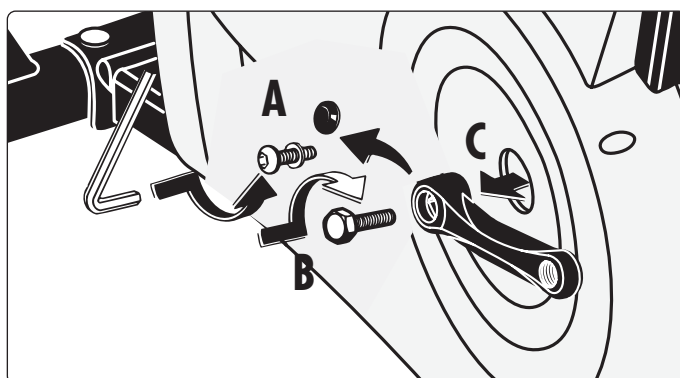
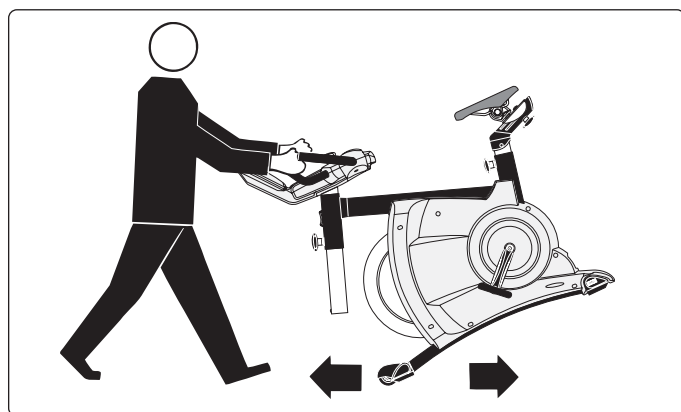
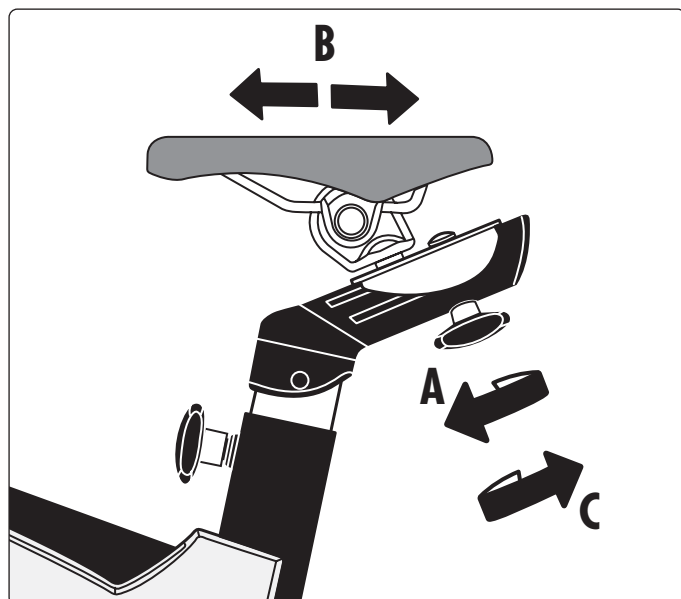
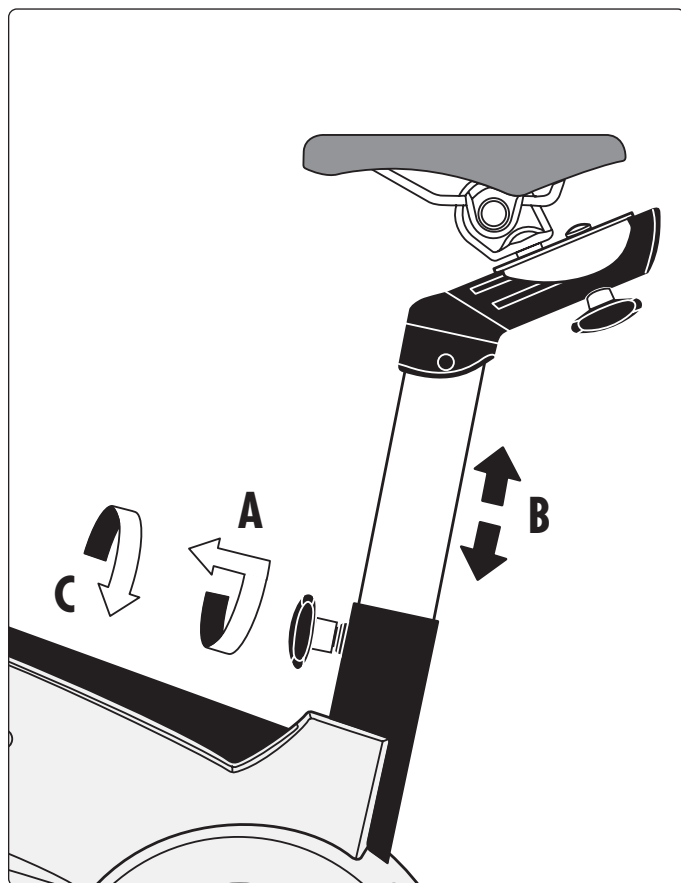

Zum Abziehen des Pedalarms entfernen Sie zuerst die Schutzkappe und Schraube (A). Halten Sie den Pedalarm fest und drehen Sie eine Schraube M12 (gehört nicht zum Lieferumfang) in die Gewindeöffnung (B). Nach einigen Umdrehungen können Sie den Pedalarm abnehmen (C).

– gb – Removal of pedal arms

To pull off the pedal arms remove cap and screw (A). Grip the pedal arm tightly, and screw in an M12 bolt (not supplied) into the thread (B). After a few turns you may take off the pedal arm (C)

– f – Démontage de la manivelle

Enlevez d'abord le capot de protection ainsi que la vis (A) avant de retirer le bras de la pédale. Tenez le bras de la pédale et vissez une vis M12 (ne fait pas partie de la gamme de livraison) dans l'ouverture de filetage (B). Vous pouvez retirer le bras de la pédale (C) après plusieurs tours.

– nl – Demontage van de krenk

Voor het losmaken van de cranks, verwijdert u eerst het beschermopje en schroef (A). Houd de crank vast en draai e g van de schroefdraad (B). Na enkele omwentelingen kunt u de crank verwijderen (C).

– e – Desmontaje de las manivelas de pedal

Para quitar la manivela de pedal hay que quitar primero la tapa protectora y el tornillo (A). Retenga la manivela de pedal y apriete un tornillo M12 (no forma parte del volumen de suministro) en la rosca (B). Después de haber efectuado algunas vueltas podrá quitar la manivela de pedal (C).

– i – Smontaggio dell'attacco del pedale

Per togliere l'attacco del pedale togliete prima il coperchietto protettivo e la vite (A). Tenete fermo l'attacco del pedale e girate una vite M12 (non compresa nella fornitura) nella filettatura (B). Dopo aver effettuato alcuni giri, potete togliere l'attacco del pedale (C).

– pl – Demontaż ramion pedału

W celu zdjecia ramienia pedału należy najpierw usunąć osłonę i wykręcić śrubę. (A). Przytrzymując ramię pedału wkręć śrubę M12 (nie należy do zakresu dostawy) w gwintowany otwór (B). Po kilku obrotach możesz zdjąć ramię pedału (C).

– cz – Demontáž kliky pedálu

Pro sejmutí kliky pedálu nejprve odejměte ochrannou čepičku a šroub (A). Pevně přidržeťte kliku pedálu a do závitového otvoru (B) zašroubujte šroub M12 (nepatří do rozsahu dodávky). Po několika otočeních lze kliku pedálu odebrat (C).

Handhabung Netzteil

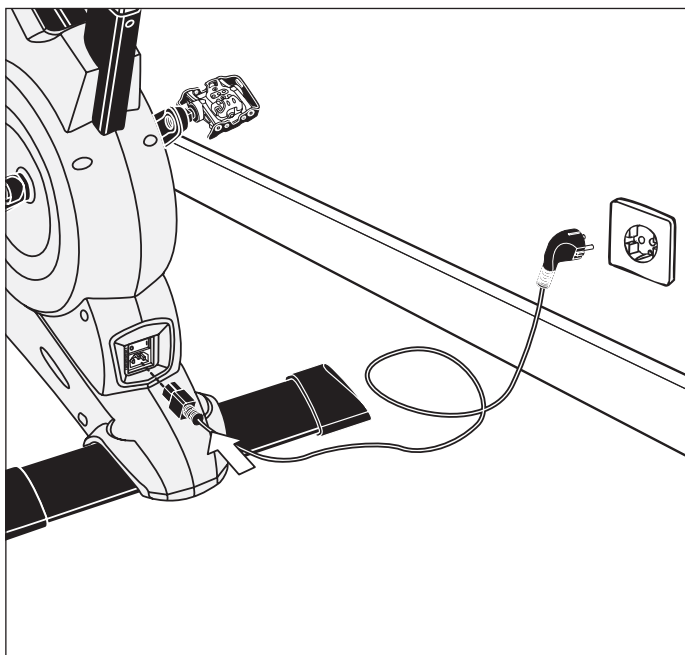

– cz – U přístrojů se síťovým zdrojem: Pozor! Provoz je přípustný pouze s originálním síťovým zdrojem obsaženým v dodávce nebo originálním náhradním dílem od firmy KETTLER (viz seznam náhradních dílů). **Jinak vzniká nebezpečí poškození.**

- d – Bei Geräten mit Netzteil: **Achtung!** Betrieb nur mit mitgeliefertem Original-Netzteil oder Original-KETTLER-Ersatzteil (siehe Ersatzteilliste) zulässig. **Ansonsten Gefahr der Beschädigung.**
- gb – For products with power supply: **Attention!** Only use with original power unit as supplied, or with original KETTLER spare part (see spare part list). **Otherwise this may result in damage.**
- f – Pour les appareils avec bloc secteur: **Attention!** Exploiter uniquement l'appareil avec son bloc secteur original qui fait partie de la fourniture ou une pièce de rechange originale de KETTLER (voir liste des pièces de rechange). **Sinon risque de détérioration.**
- nl – Bij apparaten met transformator: **Let op!** Gebruik alleen toegestaan met de bijgeleverde originele transformator of origineel KETTLER-onderdeel (zie onderdelenlijst). **Anders gevaar voor beschadiging.**
- e – En aparatos con fuente de alimentación: **¡Atención!** Funcionamiento solamente autorizado con la fuente de alimentación original suministrada o con pieza de recambio original de KETTLER (ver lista de piezas de recambio). **De lo contrario podría ocasionar daños.**
- i – Apparecchi con alimentatore: **Attenzione!** L'utilizzo è consentito soltanto con l'alimentatore originale fornito in dotazione oppure con parte di ricambio originale della KETTLER (vedasi lista delle parti di ricambio). **Altrimenti sussiste il rischio di danneggiamenti.**
- pl – Dotyczy urządzeń z zasilaczem: **Uwaga!** Eksploatacja urządzenia jest możliwa tylko z dostarczonym oryginalnym zasilaczem lub z oryginalnym urządzeniem zastępczym marki KETTLER (patrz ? Lista części zamiennych). **W przeciwnym razie istnieje ryzyko uszkodzenia.**

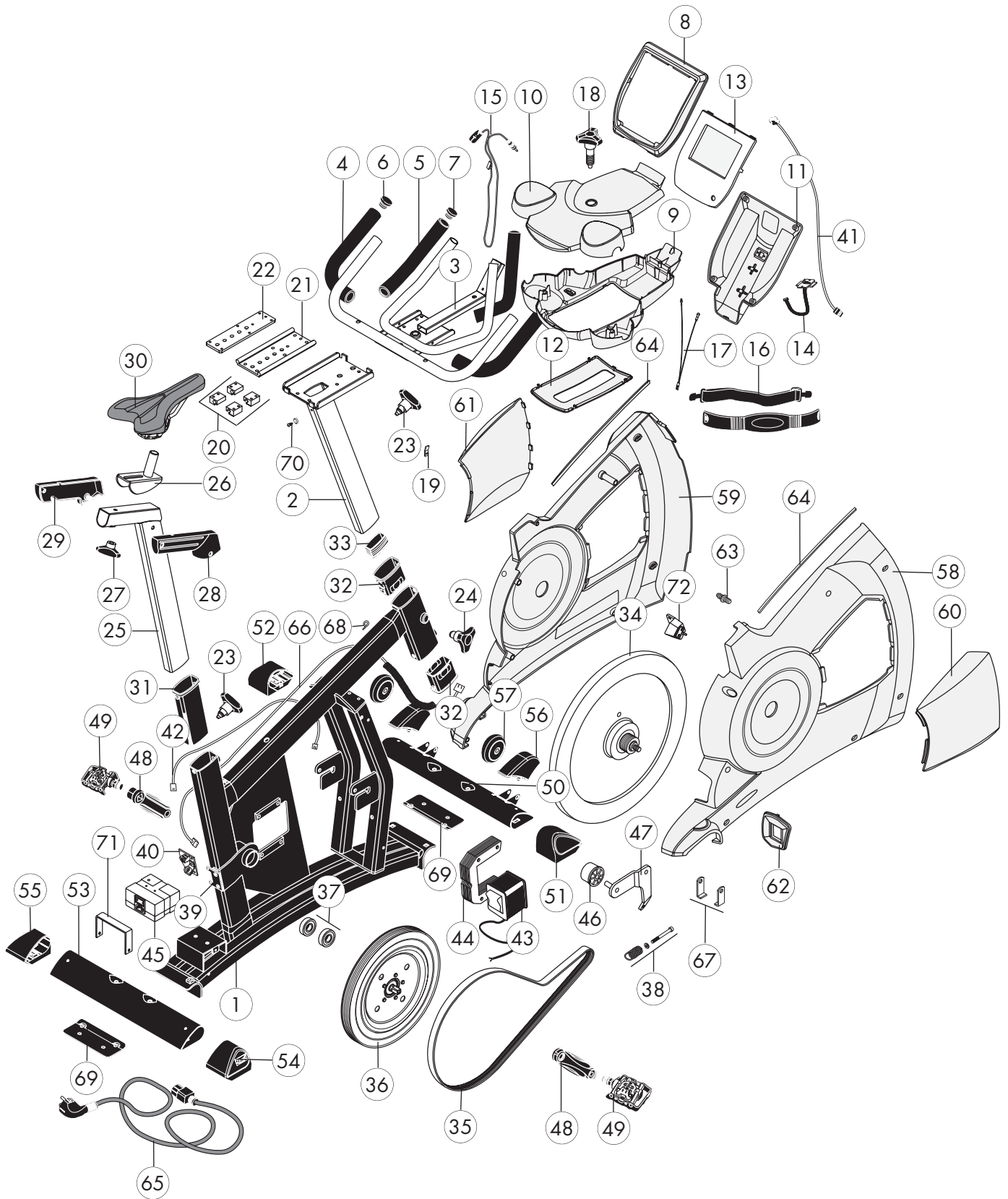

Ersatzteilliste Ergometer „ERGORACE“

Teil-Nr.	Bezeichnung	Stück	Ersatzteil-Nr. für 07988-880
1	Rahmen	1	91112010
2	Lenksäule	1	91112044
3	Lenkerschlitten	1	97202072
4	Griffschlauch für ø21x3x300 mm	2	10118138
5	Griffschlauch für ø24,5x3x285 mm	2	10118139
6	Lamellenstopfen ø25 mm	2	10100030
7	Lamellenstopfen ø22 mm	2	10100027
8	Cockpit - OT (4915) mit Befestigung	1	70129433
9	Cockpit - UT (4917)	1	70129437
10	Cockpit - VT (4916)	1	70129436
11	Cockpit - HT (4919)	1	70129438
12	Abdeckung (4964)	1	70129440
13	Computer SG1S	1	91170644
14	Schnittstelle	1	67000935
15	Pulsaufnehmer M 3406	1	67000421
16	Brustgurt	1	67002000
17	Erdungskabel	1	67000942
18	Griffschraube M16	1	91170623
19	Schraubentermial	1	67000699
20	Führungswagen	4	43001071
21	Führungsschiene	1	43001070
22	Gegenblech	1	97202074
23	Griffschraube M 16	2	91170615
24	Sterngriffschraube	1	10103072
25	Sattelrohr	1	91112043
26	Gleiprofil	1	97100588
27	Griffmutter	1	91170616
28	Sattelrohrabdeckung rechts (4910) mit Teil 29 bestellen	1	70129115
29	Sattelrohrabdeckung links (4911) mit Teil 28 bestellen	1	70129116
30	Sattel (5207)	1	72005207
31	Sattelrohrführung (4227)	1	70128781
32	Führungsteil (4967)	2	70111041
33	Deckel (4965)	2	70129128
34	Schwungrad mit Freilaufeinheit kpl.	1	91140462
35	Poly -V Riemen PJ8 1372	1	67005129
36	Antriebsrad mit Achse	1	91130137
37	Kugellager (6203-2RS)	2	33100003
38	Zugfeder (f. Umlenkrolle) und Befestigungs-Schraube	1	25635052
39	Aufnahmeblech BD1333	1	97200247
40	Platine	1	42860116
41	Stromkabel oben 600mm	1	67000933
42	Geschwindigkeitsaufnahme	1	67000707
43	Spulenkörper mit Splint	1	91140276
44	Spulenbleche	10	97201778
45	Netzteil	1	42860150
46	Spannrolle	1	70127202
47	Aufnahmeblech	1	91140461
48	Pedalarme (paar)	1	33001021
49	Pedale Typ VP-X93 (paar)	1	33300015
50	Bodenrohr	1	91112017
51	Bodenschoner rechts	1	91170611
52	Bodenschoner links	1	91170612
53	Bodenrohr	1	91112018
54	Bodenschoner rechts	1	91170613
55	Bodenschoner links	1	91170614
56	Abdeckung (4920)	2	70129114
57	Rollen	2	40814072

Ersatzteilliste Ergometer „ERGORACE“

Teil-Nr.	Bezeichnung	Stück	Ersatzteil-Nr. für 07988-880
58	Seitenverkleidung rechts (4903)	1	70129443
59	Seitenverkleidung links (4904)	1	70129444
60	Einsatz rechts (4905)	1	70129447
61	Einsatz links (4906)	1	70129448
62	Einsatz (4908)	1	70129432
63	Verbindungsbolzen (3295)	2	70128489
64	Dichtlippe	2	12518755
65	Netzleitung	1	42861110
66	Stromkabel unten	1	67000934
67	Haltewinkel	2	1701428a
68	Kabelschelle	1	10121139
69	Gegenblech	2	91112015
70	Kunststoff U-Scheibe mit Blechschraube 4,8x13	1	10108130
71	Netzteilhaltebügel	1	97003574
72	Magnetaufnahme (3105)	1	70125805
73	Schraubenbeutel (ohne Abbildung)	1	91180477

KETTLER

MADE IN GERMANY



HEINZ KETTLER GmbH & Co. KG

Postfach 1020 . D-59463 Ense-Parsit

www.kettler.net

docu 2427/04.09

Free Manuals Download Website

<http://myh66.com>

<http://usermanuals.us>

<http://www.somanuals.com>

<http://www.4manuals.cc>

<http://www.manual-lib.com>

<http://www.404manual.com>

<http://www.luxmanual.com>

<http://aubethermostatmanual.com>

Golf course search by state

<http://golfingnear.com>

Email search by domain

<http://emailbydomain.com>

Auto manuals search

<http://auto.somanuals.com>

TV manuals search

<http://tv.somanuals.com>