

**B3000 SERVICE MANUAL**  
**60-200807-000, REV C**





**Thank you for your purchase of the B3000 Keurig Single Cup Brewing System!**

The B3000 is the ultimate in Keurig Brewed® technology! The brewer features four brew sizes and a unique, easy to use, user LCD interface. The B3000 is engineered to provide many years of uninterrupted service to your customers. The B3000 is also a highly serviceable brewer. It is built in a modular fashion which makes it easy to perform preventative maintenance and service should the need arise.

We recommend that customers leave the brewer powered on at all times as it has built-in safety shut-offs, uses minimal energy, and offers the convenience of a fresh cup of coffee or tea at any time.

This manual provides installation, service and troubleshooting assistance for your B3000 brewer. Keurig also distributes service bulletins to provide you with helpful information and to keep you updated on improvements and service topics.

Keurig is committed to providing superior customer support. Should you have any unanswered questions when using this manual, please contact Keurig Field Support at 1-888 CUP BREW (1-888- 287-2739)

Please let us know if you have any comments or suggestions.

Thank you and best regards,

Dave Manly

Vice President, Marketing  
Keurig Incorporated.

# B3000 Service Manual

## Table of Contents

### I. Operation

	Page
1. B3000 Brewer Overview, Brewer Schematic / Schematic Legend	5
2. Brewer External Components	10
3. The Keurig K-Cup® Portion Pack	12
4. Appliance Safety	13
5. Brewer Setup	13
6. User Interface & Brewing Procedure	15
7. Menu Mode <b>Below Serial Number 7505</b>	19
8. Menu Mode <b>Above Serial Number 7506</b>	22
9. Draining the Brewer	26
10. Emptying the K-Cup Bin	27

### II. Construction

1. The Modules	28
a. Power	28
b. Puncture Mechanism	28
c. Hot Water Tank	29
d. Cold Water Tank	29
e. Cold Water Pump	30
f. Control Panel	30
g. Front Door	31
h. Bin Full Sensor Harness (part of wire harness module)	31
i. Drip Tray	31
j. Main PCB	32
2. Replacement Part Numbers List	33

### III. Servicing

1. Preventive Maintenance	34
2. Troubleshooting	34
3. Diagnostics/Error Codes	35
4. Removing/Installing Modules	36
a. Removal of Back and Side Panels	36
b. Power Module	37
c. Puncture Mechanism Module	41
d. Hot Water Valve Assembly	44
e. Hot Water Tank Module	46
f. Cold Water Tank Module	49
g. Cold Water Pump Module	52
h. Control Panel Module	54
i. Front Door Module	56
j. Main PCB Module	58
k. Bin Full Sensors	59

5. De-Scaling Procedure	62
6. Sanitizing / Cleaning Puncture Mechanism	64
<b>IV. Product Warranty Information</b>	<b>69</b>
<b>V. Certifications and Specifications</b>	<b>71</b>
<b>VI. Accessories Appendix</b>	
1. Water Filter	72
2. Coin Changer Accessory	73
3. Platform Unit	82
<b>VII. BIT Testing</b>	
<b>Brewers 1- 7505</b>	<b>85</b>
<b>Brewers 7506 and above</b>	<b>89</b>
<b>VIII. Revision Control</b>	<b>92</b>

# I. Operation

## 1. Brewer Overview

The Keurig B3000 Brewer is a commercial single serve coffee brewer specifically designed to be used with the proprietary Keurig K-Cup® portion pack. Coffee beans or ground coffee cannot be processed in this brewer. It can be configured with a coin vend control unit and a platform cabinet for additional K-Cup disposal capacity. It consists of a dual water tank capacity system which allows for fast sequential brewing. The brewing temperatures, water volumes and brewing times are tightly controlled. The water temperature can be set between 192 to 187 degrees F. The default setting is 192 degrees F.

The Keurig K-Cup portion pack is punctured automatically on the top and bottom when loaded and the brew process is started through the Control Module interface. In the brewing process, pressurized hot water is processed through the K-Cup, brewing the coffee and then dispensing it. The B3000 automatically ejects the used K-Cup into an internal K-Cup bin located behind the cup/drip tray door before each use. This brewing system requires a water supply that is either plumbed or pumped from a bottle in order to operate. There is no pour over filling capability.

For coin vend operation, the optional coin changer accessory kit (Part Number 5557) is available for use in the United States and Canada. This kit accepts the Coinco Quantum XXQ-G700 Series Multi Drop Bus (MDB) unit. The Coinco unit is not provided with the coin changer accessory.

## B3000 Brewer Water Flow Mechanisms

A schematic and legend showing the major components of the B3000 are provided (refer to page 8 and 9). The functions of these components are listed below.

1. **Water filling** – The B3000 is a direct plumbed machine. Municipal water is introduced to the unit through the inlet valve [X]. The supply water is then led to the cold water tank [BB] via the rigid plastic tube connected to the float valve [Y]. The cold water tank is allowed to fill approximately 16 ounces, (480 milliliters) and then the valve [X] is de-energized (closed) by the CWT float magnet proximity switch [Z] which controls the fill level. The proximity switch (located outside the tank) contains magnetically activated reed switch which is controlled by a float magnet (located inside the tank) that monitors the water level.

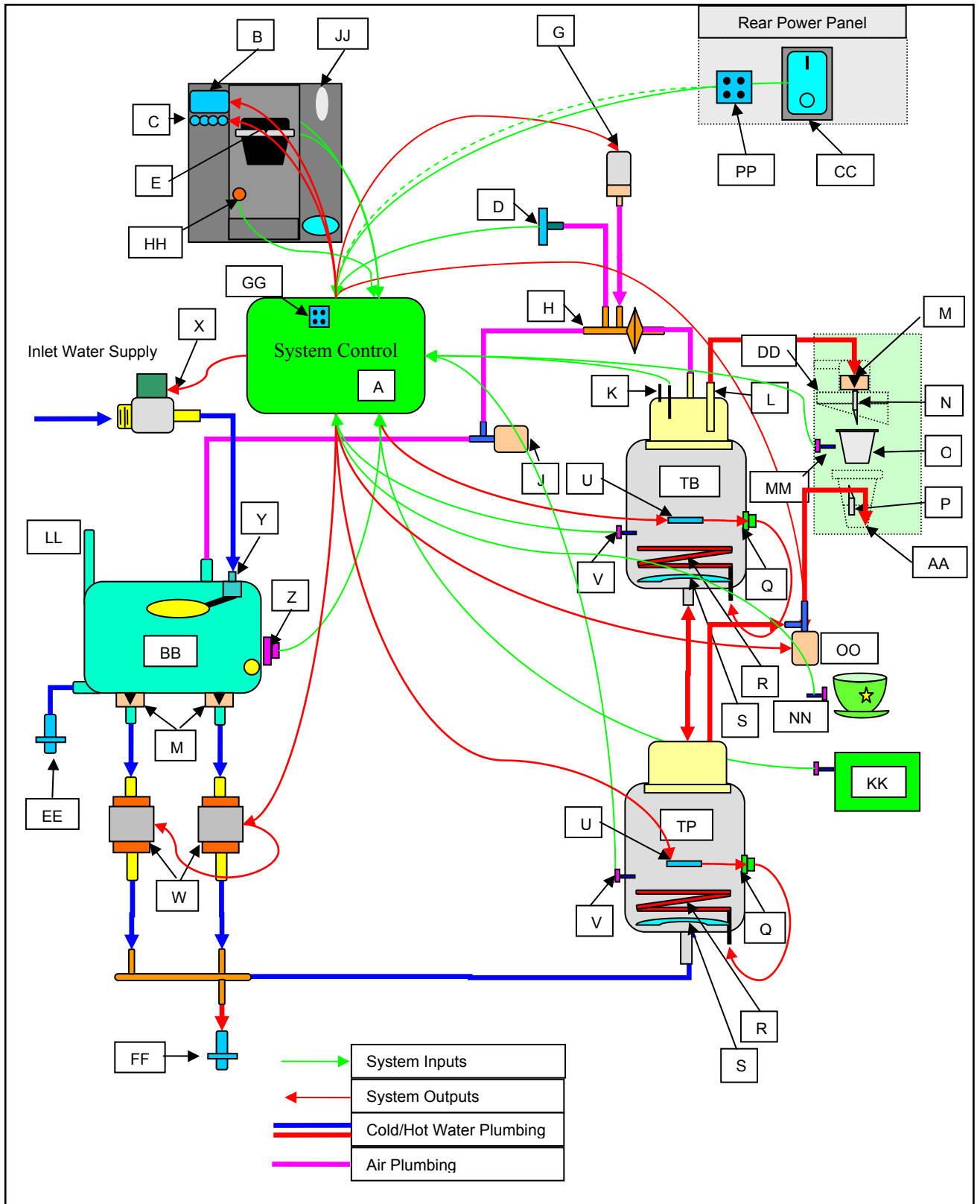
2. **The Cold water Tank** – The cold water tank [BB] functions primarily as housing for the secondary overflow protection device which is the float valve [Y] and provides the air gap necessary for back flow protection. If the normally closed inlet valve [X] were to fail open or otherwise be prevented from closing due to debris or CWT float magnet / switch failure, then the float valve [Y] would shut off the water supply once the water level rose to the level to activate the float lever. Back flow is prevented as the float valve inlet is approximately 1 1/4 inches (29 mm) above the overflow port in the cold water tank [BB]. The cold water tank also functions as the water supply reservoir for the brewing system. The water supply in the tank is fed through two check valve [M] and tubing to the two cold water pumps (CWP) [W] that supply water to the hot water tanks via the CWP elbow, CWP connectors, silicone tubing, multi-connector tee, and silicone tube.

3. **The Hot Water Tanks** – The water flows through the bottom tank and into the top tank via a seal assembly which includes two o-rings, a seal washer (between the o-rings), and the sealing cover. To allow the hot water tanks to fill, the vent valve [J] is energized (opened) to allow air to leave the system as the tanks are filled with water. Water delivered to the hot water tanks [TP] and [TB] is heated by the heating elements located inside the tanks. The only one heater at a time is allowed to energize and the heater in the top tank (brew tank) has priority. The water temperature is controlled by the thermistors [V] located in each tank. To control volume stainless steel conductive probes are used to sense the brew volumes of 4, 6, 8, and 10 ounces (120, 180, 240, and 300 milliliters). In order to brew the system is closed, vent valve [J] de-energized (closed) to allow pressurization.

4. **The Puncture Mechanism** – the mechanism [DD] consists of the K-cup holding and puncturing apparatus, a hot water delivery and brewed coffee path, and the hot water dispense valve [OO]. To brew coffee one lifts the handle to present the K-cup holder [AA]. A K-cup is placed in the holder and the handle is returned to the closed position. Upon closing the mechanism, the K-cup is punctured on the top first by the entrance needle [N] and then the bottom by the exit needle [P]. The holes created in the K-cup by the two needles are sealed about the needles by gaskets. Once the K-cup is in this 'ready to brew' state and a cup is placed on the drip tray, brewing can commence. To brew, the system is closed, vent valve [J] de-energized and the brew pump [G] is energized. The brew pump pressurizes the system to approximately 4 psi (27.6 kPa). The air is delivered to the top of the brew tank via a silicone tube by way of the filter tee [H]. The water in the brew tank is forced out of the tank through the integral brew tube [L] in the upper hot water tank cover. The water flows out of the top cover through a silicone tube to the entrance elbow which contains a check valve [M]. The water flows next through the entrance needle, contacts the coffee grounds in the K-cup, and brewed coffee is delivered through the exit needle to the cup located on the drip tray.

5. **Dispensing Hot Water** - To deliver hot water only, the system is closed, vent valve [J] is de-energized, and the hot water dispense valve [OO] is opened. Through a combination of the force of gravity and a pressure boost from the brew pump, water now flows from the lower hot water tank cover thru a silicone tube, the hot water dispense valve [OO], a silicone o-ring, seal cover, and the hot water trough. The water does not take the same path as in the coffee brewing process because the boost in pressure from the brew pump [G] is lower than the cracking pressure of the brew path check valve [M].

# Brewer Schematic

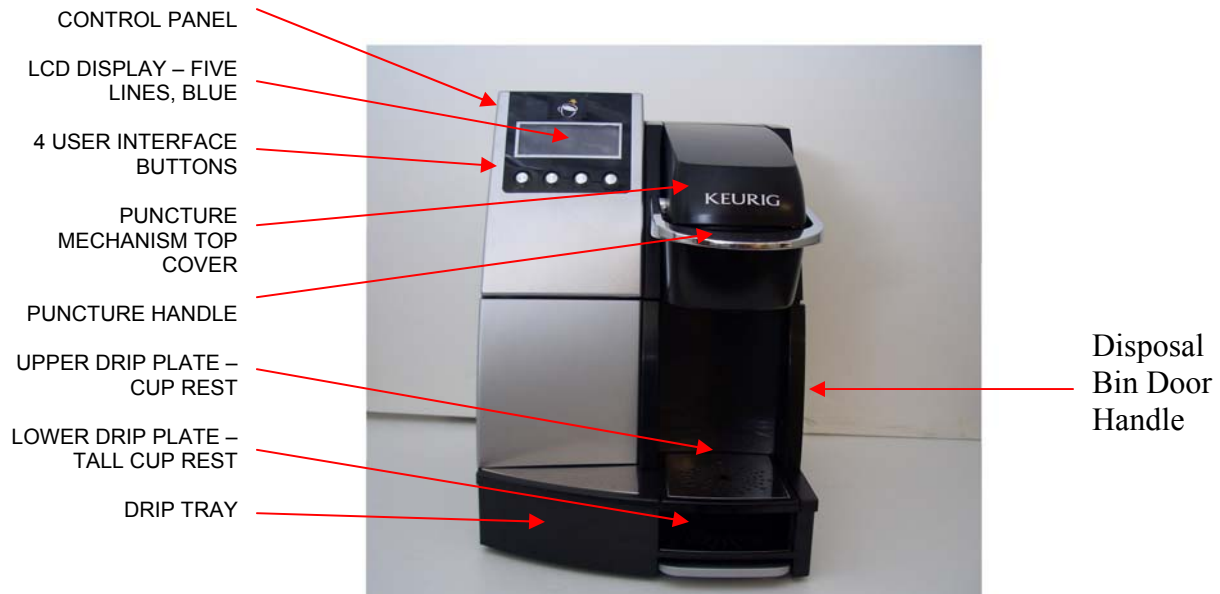




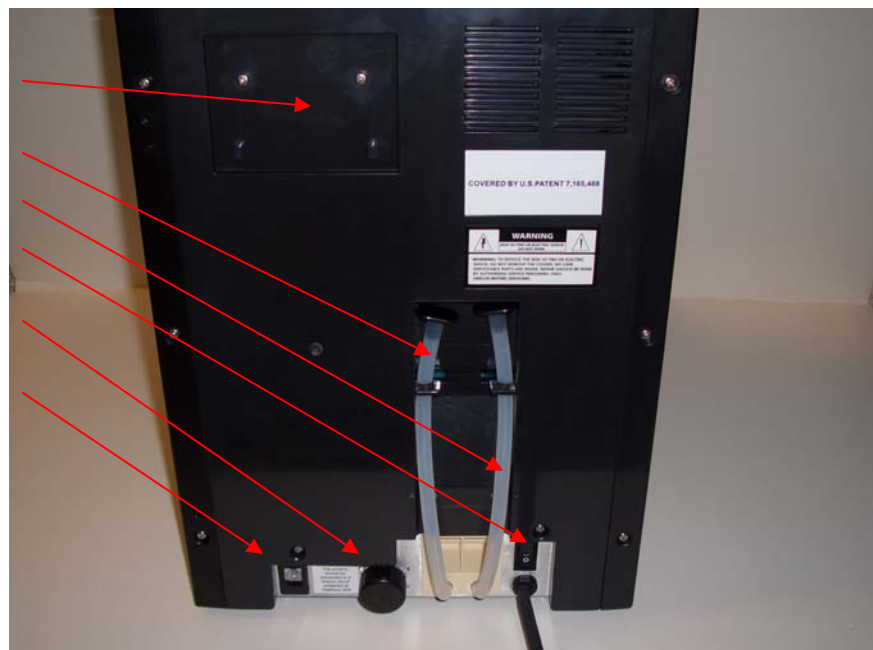
## BREWER SCHEMATIC LEGEND

A	Electronics, 3 PCBAs <u>The Processor:</u> <u>B3000 I/O Overview</u>	B	LCD User Interface	C	4 Push buttons / LEDs
D	Pressure Transducer	E	Puncture mech. Switch		
G	Brew Pump	H	Filter Tee	J	Vent Valve
K	4 Brew Vol Conduct. Probes	L	Brew Tube	M	Check Valves (3)
N	Entrance Needle	O	K-Cup® Portion Pack	P	Exit Needle
Q	Auto reset TCOs (2)	R	Heating Elements (2)	S	Baffles (2)
TB, TP	Hot Water Tanks. Brew, Preheat	U	Non-reset TCOs (2)	V	Thermistors (2)
W	Cold Water Pumps (2)	X	Inlet Water Valve	Y	Mechanical Float Valve
Z	CWT Float Magnet / Switch	AA	K-Cup® Holder Assembly	BB	Cold Water Tank
CC	Power Switch and circuit breaker	DD	Puncture Mechanism Assy.	EE	Cold Water Tank Drain Valve
FF	Hot Water Tank Drain Valve	GG	ICD2 programming Port	HH	Maintenance mode Push Button
JJ	Optional Coin Changer	KK	Bin and bin sensor	LL	CWT vent to bin
MM	K-Cup® sensor	NN	Mug Sensor	OO	HW Dispense Valve
PP	Coin changer interface				

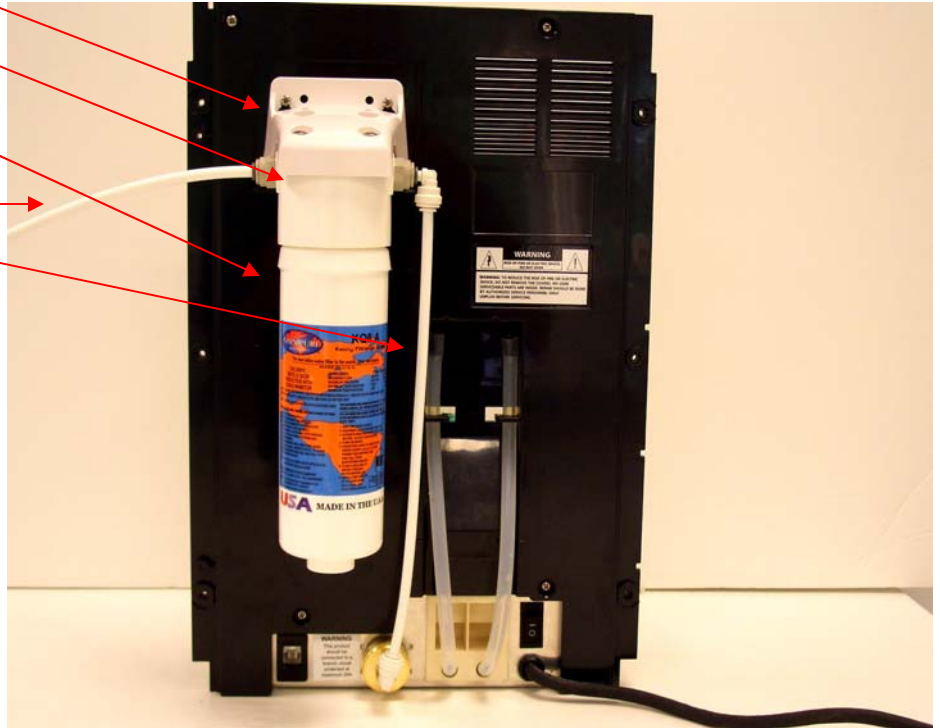
## 2. Brewer External Components



- FILTER MOUNTING AREA
- HOT WATER TANK DRAIN TUBE
- COLD WATER TANK DRAIN TUBE
- POWER SWITCH
- INLET VALVE
- RJ11 COIN CHANGER CONNECTOR



- WATER FILTER BRACKET
- WATER FILTER HEAD, KQ8A
- WATER FILTER CARTRIDGE, KQ8A
- 3/8" or 1/4" DIAMETER TUBING (FROM WATER SUPPLY) (FROM FILTER TO INLET VALVE)



- PUNCTURE HANDLE ROTATED BACK WITH PUNCTURE MECHANISM IN OPEN POSITION
- K-CUP
- K-CUP HOLDER



### 3. The Keurig K-Cup® Portion Pack

The Keurig B3000 Brewer may only be utilized in conjunction with the single serve portion pack called the Keurig K-Cup. The K-Cup is fitted with a paper filter that is heat sealed to the inside upper edge of the plastic cup.



Depending on the individual blend, up to approximately 9 to 14 grams of premium freshly ground coffee is added. The K-Cup is nitrogen purged to remove oxygen and heat sealed with a three ply foil lid to lock in freshness for at least 6 months.



During the brewing process water is introduced into the K-Cup under pressure via the entrance needle, located in the Puncture Mechanism Module. The hot water extracts the coffee and passes it through the filter paper. The exit needle, located on the outer edge of the K-Cup holder, allows the brewed coffee to be dispensed into a cup or mug.

#### 4. Appliance Safety

When using electrical appliances, basic safety precautions must always be followed. Read all instructions before using this brewer. **Failure to comply with the instructions risks equipment damage, fire or severe bodily injury.**

##### **WARNING: ALWAYS UNPLUG THE BREWER BEFORE SERVICING**

- To reduce the risk of fire or electric shock, do not expose this brewer to rain or moisture.
- Do not immerse the brewer in water, as this could lead to electric shock, electrical and or mechanical malfunctions.
- Do not use brewer for other than its intended use.
- Both the Cold Water Tank (CWT) and the Hot Water Tank (HWT) should be drained prior to moving the B3000 from one location to another.

##### **POWER SUPPLY**

Only use a correctly wired and grounded 120VAC / 60Hz socket outlet rated for at least 15A service. It is recommended that a Ground Fault Circuit Interrupter (GFCI) outlet be used.

- Avoid sharing the same outlet with other appliances.
- Your brewer is equipped with a molded, grounded three prong polarized AC line plug. This is a safety feature. Do not defeat the safety purpose of the polarized plug.
- The system requires a 3-wire grounded outlet with a minimum of 15 amp service.
- Do not use extension cords with this brewer.

#### 5. Brewer Setup

##### **Unpacking Instructions**

**WARNING: Keep all plastic bags away from children.**

1. Place Brewer box on its side on a large steady surface such as a table, countertop, or on the floor. Open the box from the end that says UP.
2. Remove the Quick Start Guide, Use & Care Guide and other literature.
3. Reach into the box and grasp the poly foam packing that protects the Brewer.
4. Carefully pull the poly foam toward you and out of the box. Remove the poly foam packaging material surroundings the brewer.
5. Place the brewer upright on a flat, steady surface.
6. Remove the plastic bag.
7. It is recommended that you save all packing materials and shipping carton in the event that the brewer must be shipped or stored.

## Filter Requirements

The Keurig B3000 brewer system requires the use of a water filtration system to optimize the coffee flavor and brewer reliability. Two mounting holes with screws have been provided on the back of the brewer for this purpose.

Keurig recommends the Omnipure KQ8A filter. A filter kit (part number 5025) is available from Keurig. This kit contains a KQ8A filter, filter head, and mounting bracket.

**NOTE: NO PLUMBING CONNECTORS ARE PROVIDED WITH THIS KIT.**

**All KQ8A filter cartridges must have a minimum of four gallons of water run through it after mounting to the brewer and before they are connected to the brewer's Inlet Valve at the install location. This procedure will prevent fine particles of carbon from entering and clogging the water inlet valve.**

## Getting Started

You will need several tools for the installation or servicing the B3000 brewing system. They are as follows:

- Two Number 2 Phillips screw drivers (8" and 12")
- Pliers (Regular Adjustable and Needle Nose)
- Wire Cutters
- 6 mm Nut Driver

Next:

- a) Attach a 3/4" female garden hose connection that will reduce to either a 3/8" or 1/4" connection to the Inlet Valve.
- b) Mount the filter assembly to the brewer using the screws provided on the back of the brewer.
- c) Flush the filter **BEFORE** connecting to the Inlet Valve.
- d) Plug brewer into a dedicated GFCI outlet. If the electric circuit is overloaded with other appliances, the circuit breaker may trip. If possible, the brewer should be operating on its own circuit, separate from other appliances. Never use an extension cord.

## 6. User Interface & Brewing Procedure (Without a coin changer)

**IMPORTANT:** The brewer must be primed for its first use as set forth below. If Spanish or French are going to be the primary language, then you must go to the **MENU MODE** (page 19) and change the language before proceeding with the priming of the brewer. The brewer's default language is English.

**NOTE:** The B3000 power switch uses “0” for OFF and “—” for ON.

### Priming the Brewer

1. Place a cup or mug (8 oz Min) on the Drip Tray Plate (if not done, the brewer will prompt for the cup or mug later in the priming sequence)
2. Press power switch to the “—” position.

3. At power up, the brewer will display the following:

**KEURIG B3000 BREWING SYSTEM**

4. The display will automatically change to:

**CONNECT WATER AND THEN PRESS FLASHING BUTTON**

5. After water is connected, then press button.

6. The display will read:

**PRIMING**

7. Then automatically change to:

**PRIMING  
HEATING - PLEASE WAIT**

8. After heating has taken place the display will read:

**PLACE YOUR CUP  
OR SELECT ' CONT '**

9. After placing the cup the screen will read:

**PRESS FLASHING BUTTON  
TO CONTINUE**

10. Press the flashing button and conduct a water only brew.

11. After the water only brew is complete the unit is primed and the following will be displayed:

**PRIME COMPLETE**

12. Next you will read:

**HEATING – PLEASE WAIT**

13. After heating has taken place the screen will show:

**(With a Coin Changer)**

**READY – CHOOSE K-CUP  
LIFT HANDLE**

**READY  
DEPOSIT XXX CENT**



1. When the LCD displays the above information, the brewer is ready for use.
2. Select a K-Cup portion pack.

**NOTE: Do not remove the foil lid or puncture the K-Cup portion pack.**

3. Lift the puncture mechanism handle. The K-Cup holder will open towards you.

**CAUTION: There are two sharp needles that puncture the K-Cup portion pack, one in the puncturing mechanism and the other in the bottom of the K-Cup holder. To avoid risk of injury, do not put your fingers in the K-Cup chamber.**

4. Place a K-Cup in the K-Cup holder.



5. Lower the handle completely to close the puncture mechanism



- Place a cup or mug on the Cup/Drip Tray plate.



- The LCD screen will display the image below. A choice of 4, 6, 8, and 10 oz cup sizes are available. Make cup size selection at this time.



- After the selection is made, the image below will display which cup size is brewing by having the respective button corresponding to the volume size being illuminated.



**CAUTION:** There is extremely hot water in the K-Cup holder during the brew process. To avoid risk of injury, do not lift the handle or open the K-Cup holder during the brewing process.

9. At the end of the brewing process the image below will be displayed for 4 seconds.



10. There may be a short pause (approximately 20 seconds) before the next brewing process can begin. The entire brew process lasts for approximately 40 to 52 seconds (depending upon brew size selected) and ends with a burst of air to remove all liquid coffee or tea from the K-Cup.

11. Enjoy your first cup of Keurig Brewed gourmet coffee or tea!

**NOTE:** Following the brew, your brewer will fill in preparation for the next brew. The pump will make a vibrating sound. This is normal.

### Dispensing Hot Water

The B3000 brewer is capable of dispensing hot water for making hot chocolate, instant soups etc. The path of the water delivery is separate from the coffee delivery path.



One of the button options is 'Hot Water'. Hot water will be dispensed as long as the button is pressed and held delivering a total of 8 oz max before refilling. If the button is not lit, wait for heating to complete.

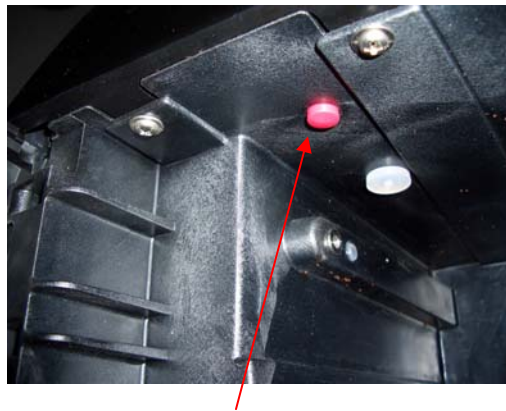
## 7. Menu Mode (For brewers with serial numbers 1 thru 7505)

The Menu Mode allows you to:

- Set the language to be displayed.
- See the number of brew cycles that the brewer has completed.
- Prime after draining.
- Set the brewer to vend / no vend.
- Set pricing.
- Adjust the brew temperature between 192 and 187 degrees F (89 and 86 degrees C).
- Invert the background text color display intensity.
- List your telephone service number. (Scroll and set all ten digits, using the NEXT and ADJUST buttons).
- List the LAST brewer error code.

To enter the **MENU MODE**

1. Press the power button, located on the rear of the brewer, to the “0” position.

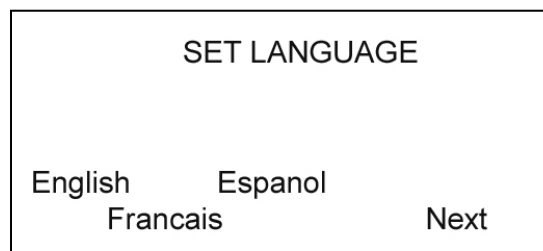


2. Open the K-Cup bin door and locate the **RED** button at the top of the bin area.
3. Press the power button, located on the rear of the brewer, to the “-” position. Within 2 seconds, push this **RED** button four times.

The first screen displayed will be where you change the default language to either Spanish or French, if English is not going to be the primary language displayed.

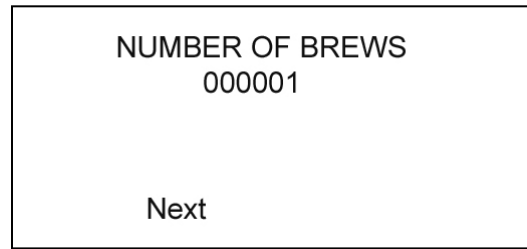
**NOTE:** If this screen does not appear, then repeat steps 1 and 3 again until it does. Scroll thru the menu screens answering the prompts that appear.

1. Once the menu is accessed the display will look like this (set language):

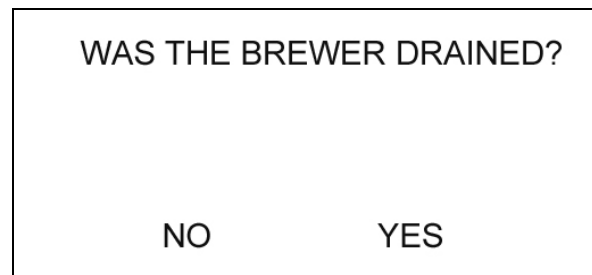


B3000 SERVICE MANUAL  
60-200807-000, REV C

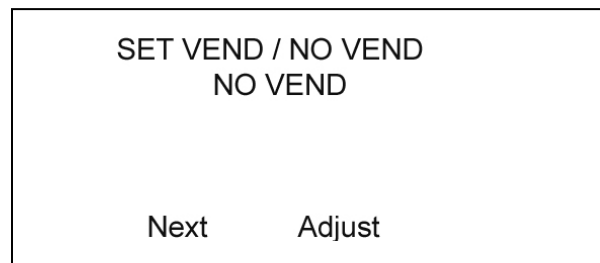
2. Press the 'Next' button.
3. The display will look like this (number of brews):



4. Press the 'Next' button.
5. The display will look like this (was brewer drained):



6. Press the 'Yes' or 'No' button as appropriate.
7. The display will look like this (set vend / no vend):



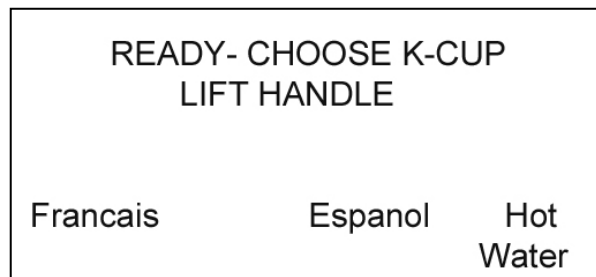
8. If a coin unit is being used, Press 'Adjust' button to 'Vend at Set the price' (image on left below). Then press next button

9. The display will look like the image on the right below. Adjust price by pressing the + or – button to get desired price. Adjustments are in \$0.05 increments.



10. Press the 'Next' button after selection is made.

11. The next display will read 'Set the Brew Temp' at the display continue to press the next button until the following display is seen, and then the brewer and coin changer unit are ready for operation.



**NOTE: YOU MUST SCROLL THROUGH THE MENU MODE COMPLETELY. FAILURE TO DO SO WILL NOT SAVE ANY CHANGES THAT HAVE BEEN MADE.**

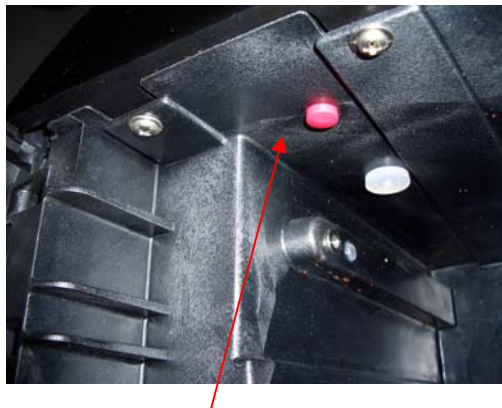
## 8. Menu Mode (For brewers with serial numbers 7506 and above)

The Menu Mode allows you to:

- Set the language to be displayed.
- See the number of brew cycles that the brewer has completed.
- Set the brewer to vend / no vend.
- Set pricing.
- Adjust the brew temperature between 192 and 187°F (89 and 86 degrees C).
- Invert the background text color display intensity.
- List your telephone service number. (Scroll and set all ten digits, using the NEXT and ADJUST buttons).
- Turn ON / OFF Mug Light.
- Turn ON / OFF the Hot Water Valve.
- Set available Cup Sizes.
- List the LAST brewer error code.

To enter the **MENU MODE**

1. Press the power button, located on the rear of the brewer, to the “0” position.



2. Open the K-Cup bin door and locate the **RED** button at the top of the bin area.
3. Press the power button, located on the rear of the brewer, to the “-” position. Within 4 seconds, push this **RED** button four times.

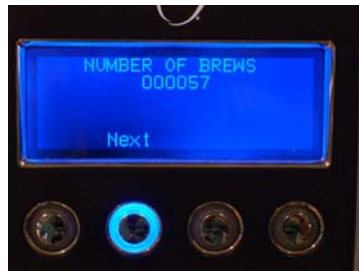
The first screen displayed will be where you change the default language to either Spanish or French, if English is not going to be the primary language displayed.

**NOTE:** If this screen does not appear, then repeat steps 1 and 3 again until it does. Scroll thru the menu screens answering the prompts that appear.

1. Once the menu is accessed the display will look like this (set language):



2. Press the 'Next' button.
3. The display will look like this (number of brews):



4. Press the 'Next' button.
5. The display will look like this (set vend / no vend):



6. If a coin unit is being used, Press 'Adjust' button to 'Vend at Set the price'. Then press next button.
7. The display will look like these (set vend price):



8. Adjust price by pressing the + or – button to get desired price. Adjustments are in \$0.05 increments.
9. Press the ‘Next’ button after desired amount has been set.
10. The next display will look like these (set the brew temp). The temperature can be adjusted in one degree increments between 187 – 192 °F by pressing the “Adjust” button.



11. The next screen will look like these (invert display colors). You can changes the display to LIGHT back ground with DARK letters by pressing the “Adjust” button.



12. The next screen will look like this (set service phone #). Enter your phone number here. You must scroll through all ten digits.



13. The next screen will look like this (set mug light). You can disable the mug placement sensor by pressing the “Adjust” button





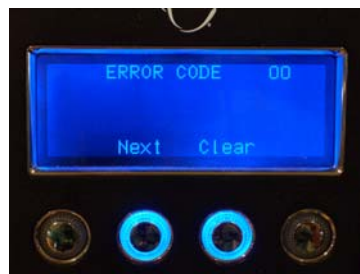
14. The next screen will look like this (hot water dispense). You can disable the plain Hot Water button by pressing the “Adjust” button.



15. The next screen will look like this (select cup sizes). You can select which cup sizes you want the brewer to dispense. You can disable up to 3 cup sizes. One cup size has to be on.



16. The next screen will look like this (error code). The last error condition that the brewer detected will be display in this menu. See the ERROR CODE chart on page 41 for code definitions



17. The next screen will look like this (was brewer drained). Press “NO” or “YES” accordingly.



This is the last MENU for the Menu Mode.

**NOTE: YOU MUST SCROLL THROUGH THE MENU MODE COMPLETELY. FAILURE TO DO SO WILL NOT SAVE ANY CHANGES THAT HAVE BEEN MADE.**

## 9. Draining the Brewer

When you wish to drain the brewer, the following steps must be followed:

1. Press the power button to the “0” position and unplug power cord.
2. Shut off water and disconnect water supply to the brewer. Turn the brewer around so the back is facing you.
3. Move the brewer close to the edge of a sink or large bucket so that the drain hoses hang over either the sink edge or into the bucket
4. Remove both the Hot Water and Cold Water hoses from their clips. Remove drain plugs from each hose.

**CAUTION: THE WATER WILL BE VERY HOT!**

5. When the flow of water stops, the brewer’s internal hot water tank and cold water tank will be empty.

**NOTE: The brewer is drained by gravity. It will take approximately 3 minutes to complete. There will always be a small amount of water left in the drain hoses.**

## 10. Emptying the K-Cup Bin

The used K-Cups are automatically ejected into the internal K-Cup bin. When the K-Cup bin requires emptying, the brewer will display:

### EMPTY K-CUP BIN

To empty the K-Cup bin, open the brewer door by grasping the door handle and swinging door fully open to remove bin from brewer. Dispose of the used K-Cups and reinstall the bin. The bin will **ONLY** go back inside the brewer one way.



BREWER DOOR IS HINGED,  
ALLOWING ACCESS TO K-CUP  
BIN



DOOR FULLY OPEN WITH K-CUP  
BIN VISIBLE



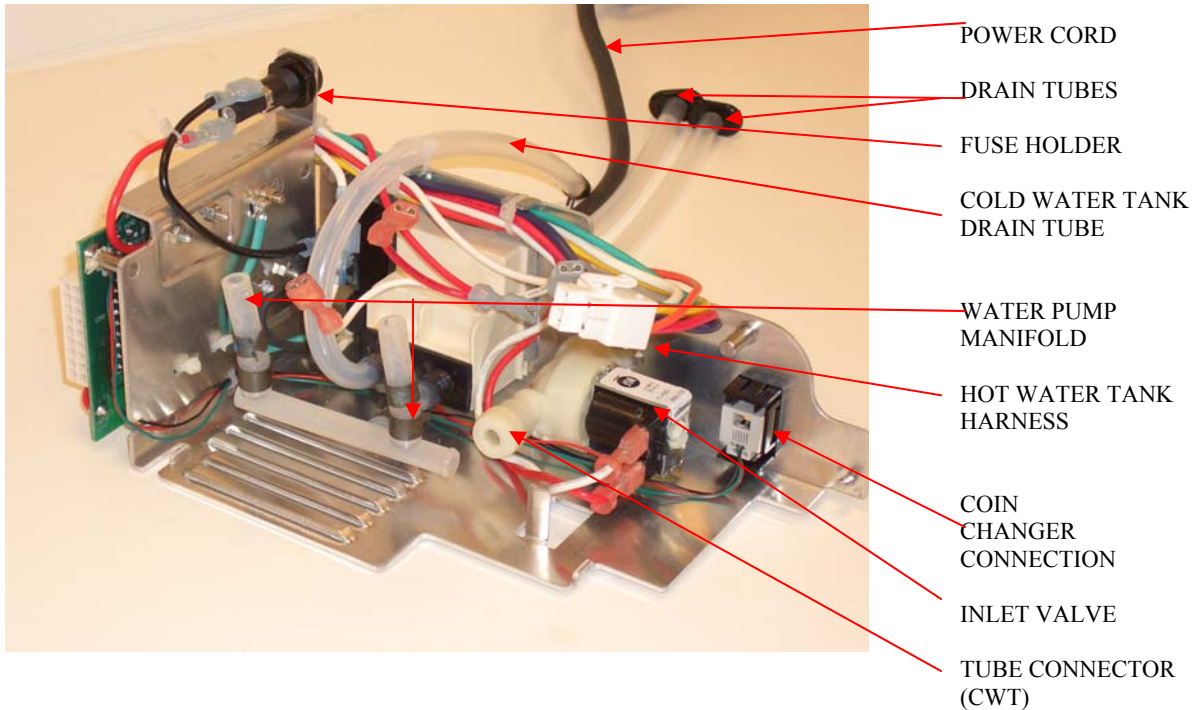
K-CUP BIN REMOVED FROM  
BREWER

## II. Construction

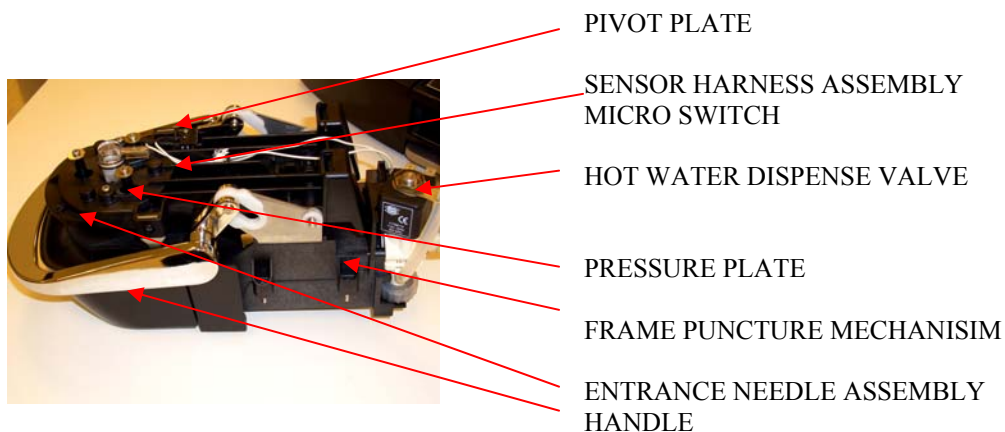
### 1. The Modules

What follows are images of the individual modules to show their general configuration. Not all of the parts in the module are listed.

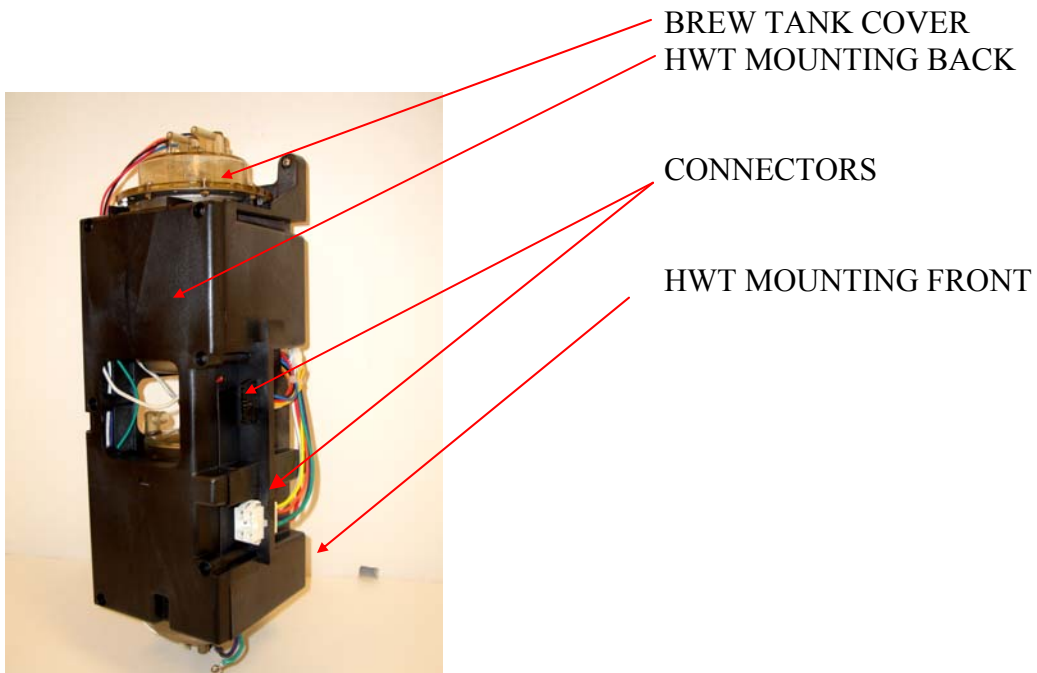
#### A. **Power** – located at lower rear of brewer:



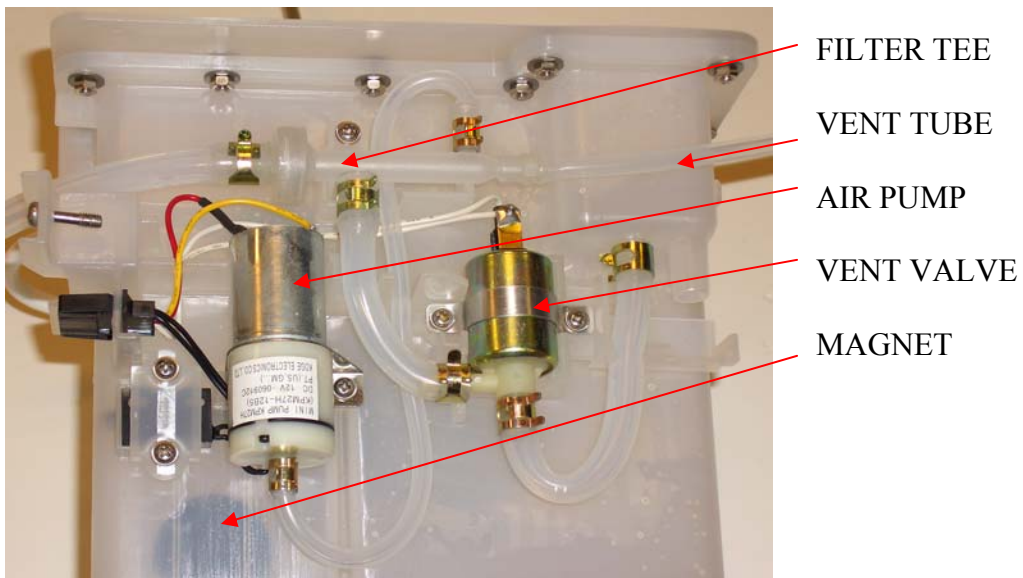
#### B. **Puncture Mechanism** – located at the upper right front of brewer:



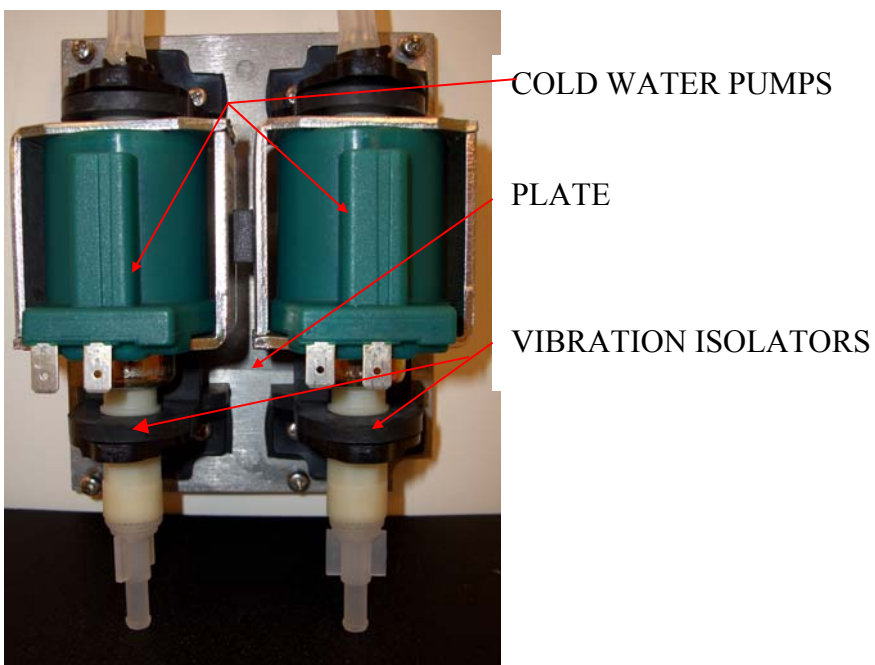
**C. Hot Water Tank – located at the left rear of brewer:**



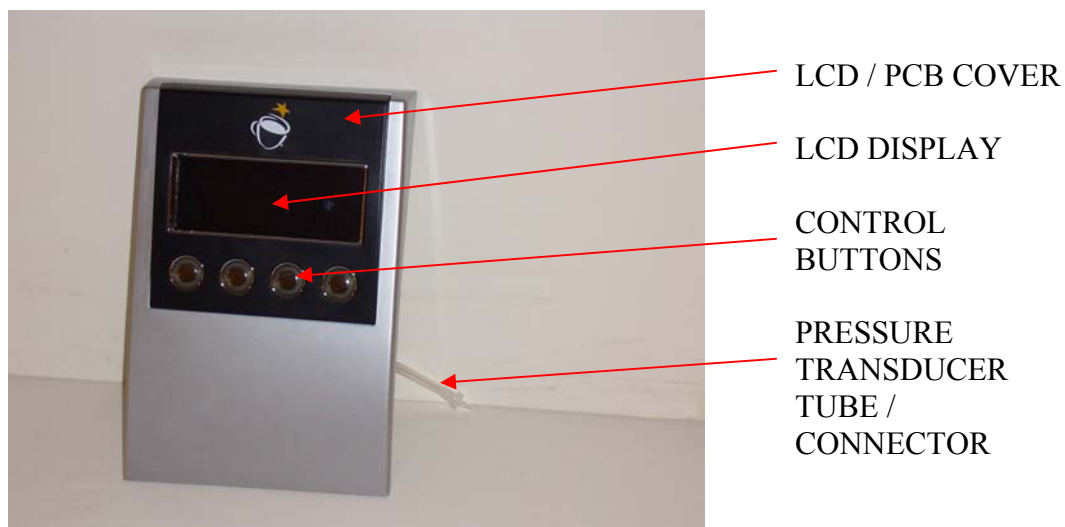
**D. Cold Water Tank – located at the upper right rear of brewer:**



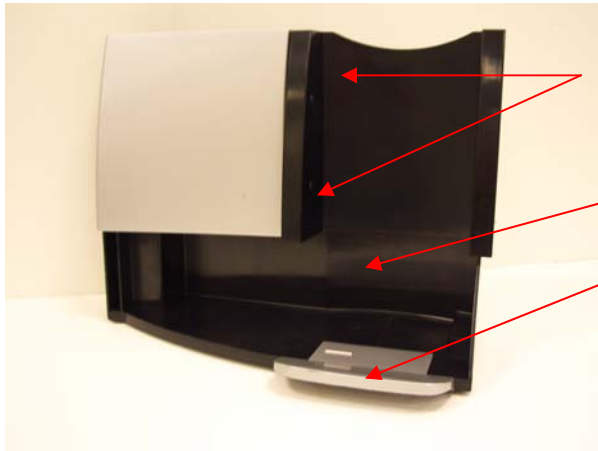
E. **Cold Water Pump** – located at the lower right rear of brewer:



F. **Control Panel** – located on the front of brewer:



**G. FRONT DOOR** – located on the front of brewer:

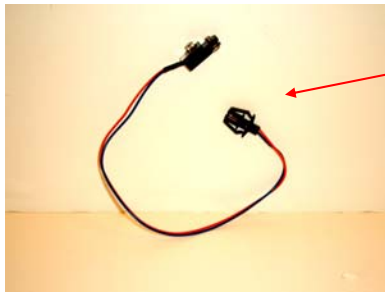


CUP PLACEMENT LED  
SENSORS

CUP/DRIP TRAY  
LOCATION

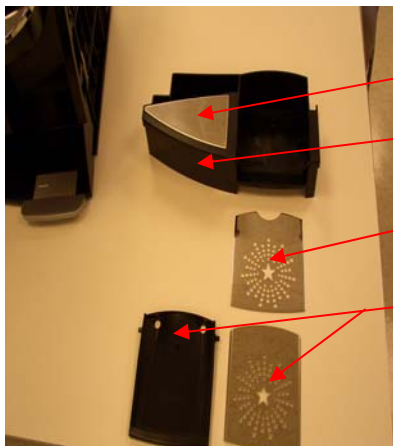
DOOR HANDLE

**H. BIN FULL SENSOR** - located on the left/right side of brewer:



BIN FULL SENSORS

**I. DRIP TRAY**– located on the front of brewer:



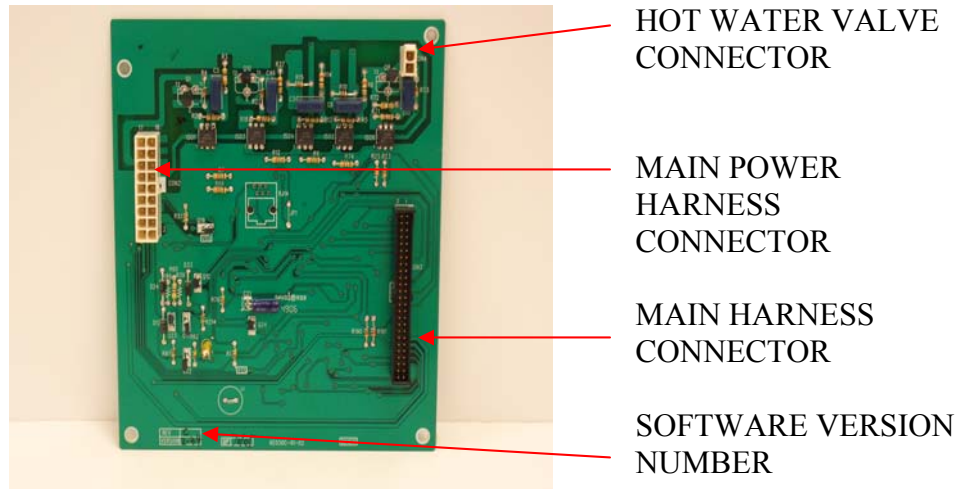
TRIM INSERT

DRIP TRAY

DRIP PLATE LOWER

DRIP PLATE UPPER  
AND BASE

**J. MAIN PCB – located on the left side looking at the front of brewer:**





## 2. REPLACEMENT PART NUMBERS

POWER MODULE	16-200904-000
K-CUP PUNCTURE MODULE	16-200905-000
HOT WATER TANK MODULE	16-200906-000
COLD WATER TANK MODULE	16-200907-000
COLD WATER PUMP MODULE	16-200908-000
CONTROL PANEL MODULE	16-200914-000
FRONT DOOR MODULE	16-200909-000
MAIN HARNESS MODULE	16-200910-000
BIN SENSOR MODULE (Included in Main Harness Module)	USE 16-200910-000
DRIP TRAY MODULE	16-200912-000
MAIN PCB MODULE	16-200913-000
HOT WATER DISPENSE VALVE ASSEMBLY	16-200894-000
K-CUP HOLDER ASSEMBLY	16-200936-000
INLET VALVE FILTER	01-201200-000
LOCKSET COIN MECH B3000	16-200962-000
CHUTE B3000	16-200951-000
INLET WATER VALVE B3000	16-200959-000
DISPOSAL BIN	16-200969-000
BASE PLATE MODULE	16-200938-000
CLAMP, HOSE, 14.81MM ID x 7.92MMW, SPRING STL	04-200819-000
CLAMP, HOSE, 9.53MM ID X 7.92MM W, SPRING STL	04-200685-000
CLAMP, HOSE, 12.45MM ID X 7.94MM W, SPRING STL	04-200872-000
CLAMP, HOSE, 13.21MM ID X 7.92MM W, SPRING STL	04-200684-000
CLAMP, HOSE, 8.51 MM ID X 7.92 MM W, SPRING STL	04-200880-000
CLAMP, HOSE, 6.1MM ID X 6.35 MM W, SPRING STL	04-200873-000
ENTRANCE NEEDLE ASSEMBLY (ENA)	16-200993-000
K-CUP HOLDER PIVOT	16-200995-000
ENTRANCE NEEDLE GASKET, SN ABOVE 7506	16-200997-000

### III. Servicing

#### 1. Preventive Maintenance

Regular cleaning of the Brewer's external components is recommended.

**CAUTION: Never immerse the base unit in water or other liquids.**

The brewer's enclosure and other external components may be cleaned with a non-toxic food grade cleaner and a damp, non-abrasive cloth.

- The Drip Tray and Drip Tray Plate should be periodically inspected and rinsed clean.
- The K-Cup Bin should be cleaned on a regular basis.
- The K-Cup holder/funnel should be periodically removed from the Puncture Mechanism and cleaned with warm water.

**CAUTION: THERE IS A SHARP NEEDLE THAT PUNCTURES THE BOTTOM OF THE K-CUP PORTION PACK. USE EXTREME CARE IN CLEANING THIS AREA.**

1. The KQ8A water filter should be replaced every 6 months.

#### 2. Troubleshooting

The B3000 has an Alpha/Numeric LCD display informing you what is wrong with the brewer, if it should develop an error. All repairs of the brewing system are done on a modular level.

By looking at the error code being displayed and reading the diagnostic chart provided in this manual, or hitting the Menu Button (page 19 for brewers up to serial number **7505**, page 22 for brewers with serial number **7506** and up) once, you will be able to determine which module needs to be replaced.

To enter the **MENU MODE** refer to page **19** for brewers up to serial number **7505**. Page **22** for brewers with serial number **7506** and up.

### 3. Diagnostics – Error Codes:

The B3000 contains real-time error detection. There are a number of operational errors that, if encountered, will disable the brewer, produce an error code onto the LCD display, and will also flash all 4 buttons on the front panel LED's to attract attention. The power may be cycled to attempt to clear the error, but if it occurs again, the same message will be displayed.

Below is a summary of all errors, their meanings and the menu messages.

<b>ERROR CODES</b>	<b>MESSAGE DISPLAY</b>	<b>PROBABLE CAUSE</b>
<b>01</b>	<b>ERROR – TCO HIGH OPEN CALL FOR SERVICE 000-000-0000</b>	<b>MODULES: POWER, HWT</b>
<b>02</b>	<b>ERROR – TCO LOW OPEN CALL FOR SERVICE 000-000-0000</b>	<b>MODULES: POWER, HWT</b>
<b>03</b>	<b>ERROR – DESCALE NOW CALL FOR SERVICE 000-000-0000</b>	<b>DESCALE REQUIRED</b>
<b>04</b>	<b>ERROR – CHECK WATER SUPPLY CALL FOR SERVICE 000-000-0000</b>	<b>MODULES: CWT, POWER</b>
<b>05</b>	<b>ERROR – RUNAWAY FILL CALL FOR SERVICE 000-000-0000</b>	<b>MODULES: CWT, POWER</b>
<b>06</b>	<b>ERROR – LOW TANK FROZEN CALL FOR SERVICE 000-000-0000</b>	<b>PREHEAT TANK COLD MODULES: HWT</b>
<b>07</b>	<b>ERROR – HIGH TANK FROZEN CALL FOR SERVICE 000-000-0000</b>	<b>BREW TANK COLD MODULES: HWT</b>
<b>08</b>	<b>ERROR – LOW TANK HI TEMP CALL FOR SERVICE 000-000-0000</b>	<b>MODULES: POWER, HWT</b>
<b>09</b>	<b>ERROR – HIGH TANK HI TEMP CALL FOR SERVICE 000-000-0000</b>	<b>MODULES: POWER, HWT</b>
<b>10</b>	<b>ERROR – COIN JAM CALL FOR SERVICE 000-000-0000</b>	<b>MODULES: COIN MECH</b>

#### 4. Removing/Installing Modules

The B3000 brewing system is modular in design. This design facilitates ease of repair at customer locations. There are no component level repair capabilities for this brewer. The following describes the removal of each of the modules.

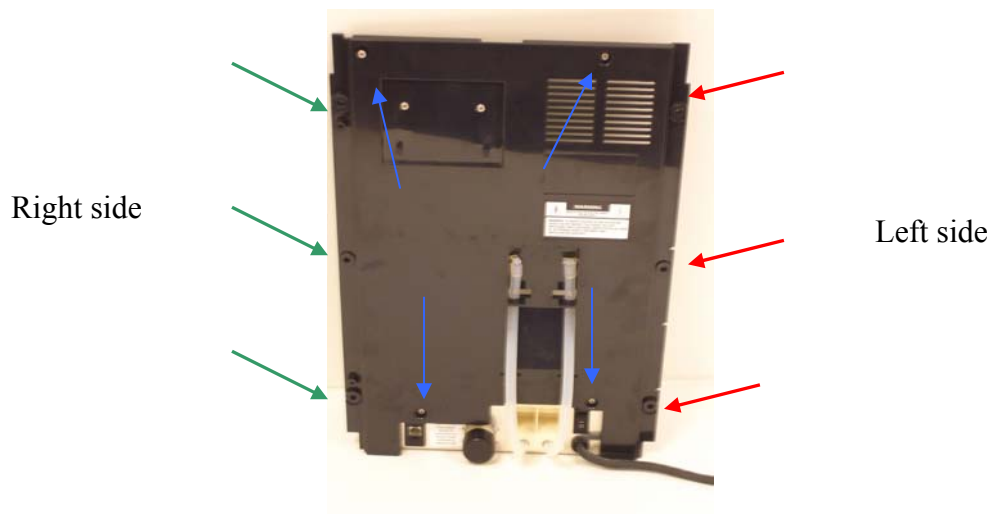
**NOTE: BOTH THE HOT AND COLD WATER TANKS MUST BE DRAINED AND THE UNIT UN-PLUGGED BEFORE ANY MODULE IS REMOVED.**

##### A. REMOVAL of BACK and SIDE PANELS

For **Right side panel** removal, locate the three screws on the left side of the back panel loosen the screws and pull side panel back for removal.

For **Left side panel** removal, locate the three screws on the right side of the back panel loosen the screws and pull side panel back for removal.

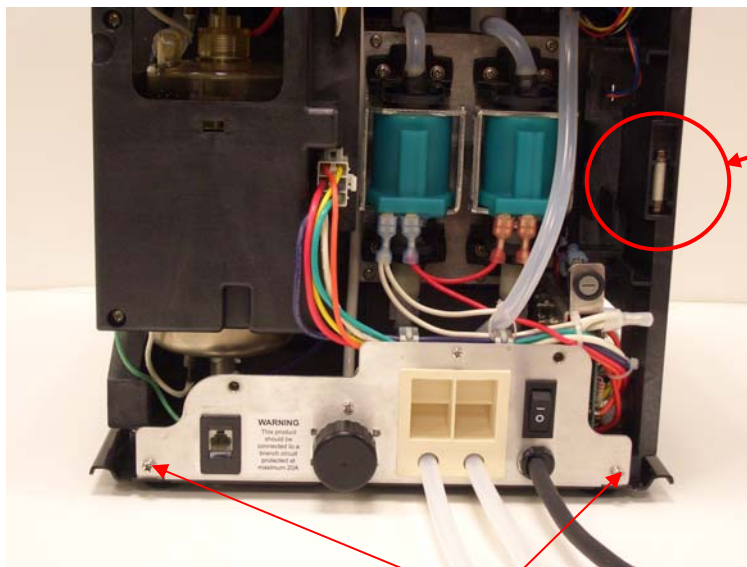
For **Back Panel removal** when both side panels are removed loosen the four screws on the back panel and remove.



NOTE: All screws are **captive** they cannot be removed from panels

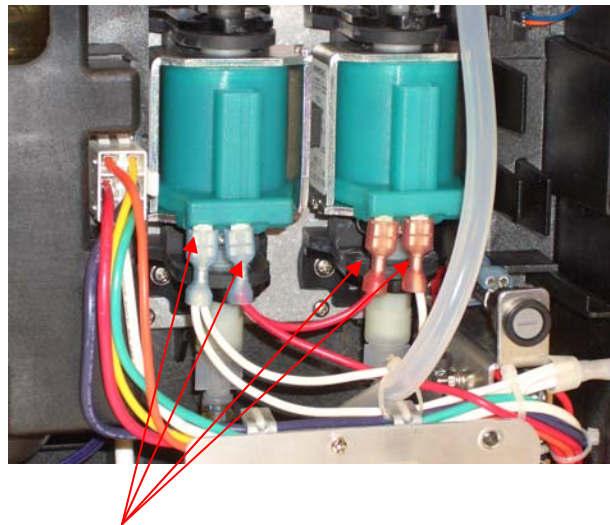
**B. POWER MODULE** (Located in the back on the bottom edge of the brewer)

See **REMOVAL of OUTER PANELS (page 36)**. After completion of panel removal, the technician must attach an **ESD** wrist strap to themselves and the metal base plate of the brewer.



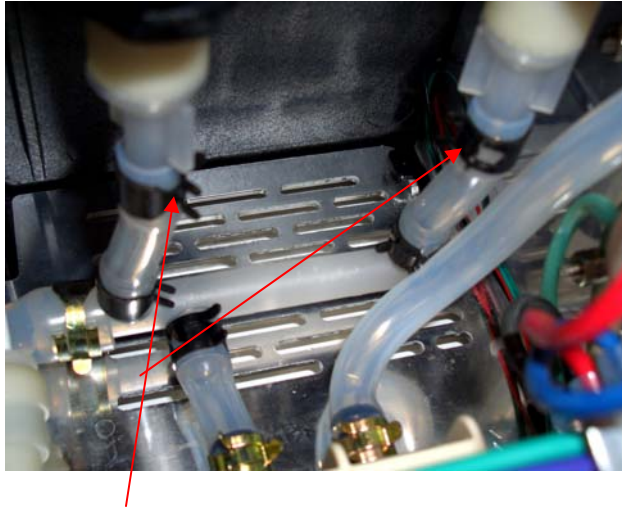
Spare Fuse Location

1. Completely loosen the two **captive** screws holding the Power Module to the bottom base plate and pull out slightly. This will help in accessing the hoses on the pumps.

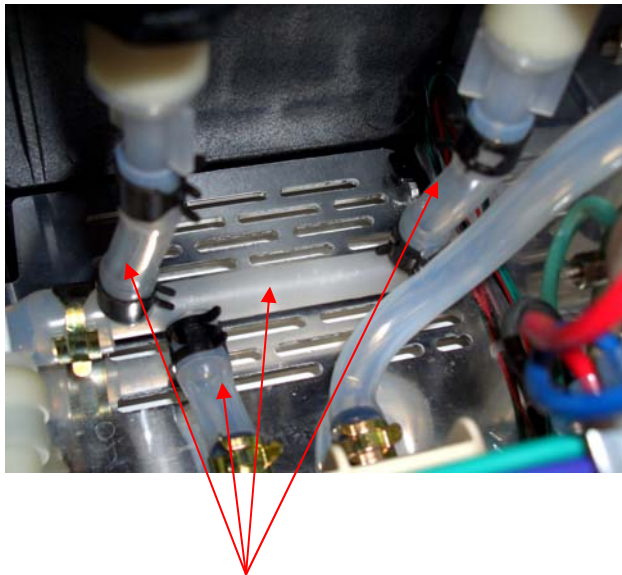


2. Prior to disconnecting the four wire connections attached to bottom of the green water pumps make a note of their respective connections. Disconnect these four wires.

**NOTE:** The wires must be reconnected to their proper connections when installing the new module. Failure to do so will result in having extremely noisy pumps while they are in operation.



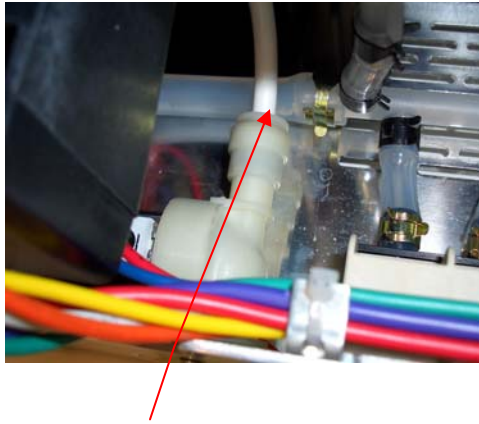
3. Disconnect the clamps and water hoses attached to the water manifold.



4. Disconnect the Multi Connector Tee manifold from the old Power Module and add to the replacement unit.



5. Disconnect the Cold Water drain tube from the bottom of the tank.

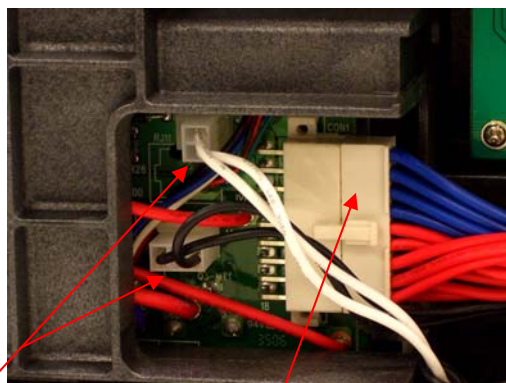


6. Disconnect the tube from the Inlet Valve that goes to the Cold Water Tank. The Inlet Valve is located on the Power Module. This is a quick release tube connection. Remove the black locking clip from the fitting if present. Push in on the collar, and pull out the tube.



7. Disconnect the wire harness attached to the Hot Water Tank module.

Looking at the left side of the brewer when facing from the front, locate the main power harness, and transformer.



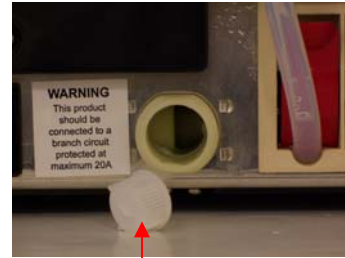
8. Disconnect the two transformer and main power harness from the Power Module PCB.
9. The Power Module can now be removed from the brewer.

10. Install the new module and connect all of the appropriate connections, hoses, and wires making sure that they are secure and tight.
11. Conduct a BIT test (see appendix VII on page 85) to insure the proper function of the brewer.

**NOTE: There is a removable filter screen located in the Inlet Valve. If this screen should become blocked by foreign material preventing water from flowing into the brewer, you can gently remove the blocked screen using a pair of needle nose pliers and insert a new one. The part # for the replacement screen is 01-201200-000.**



Inlet Valve Screen  
Inserted

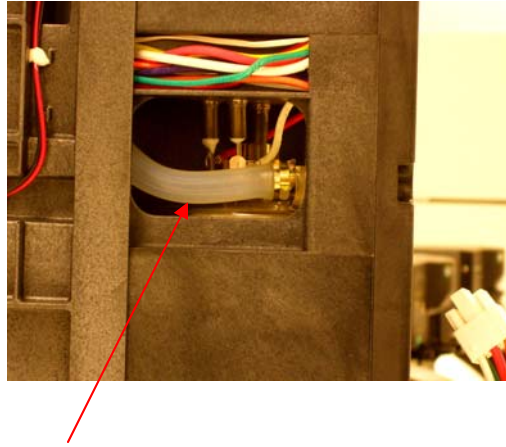


Inlet Valve Screen  
Removed



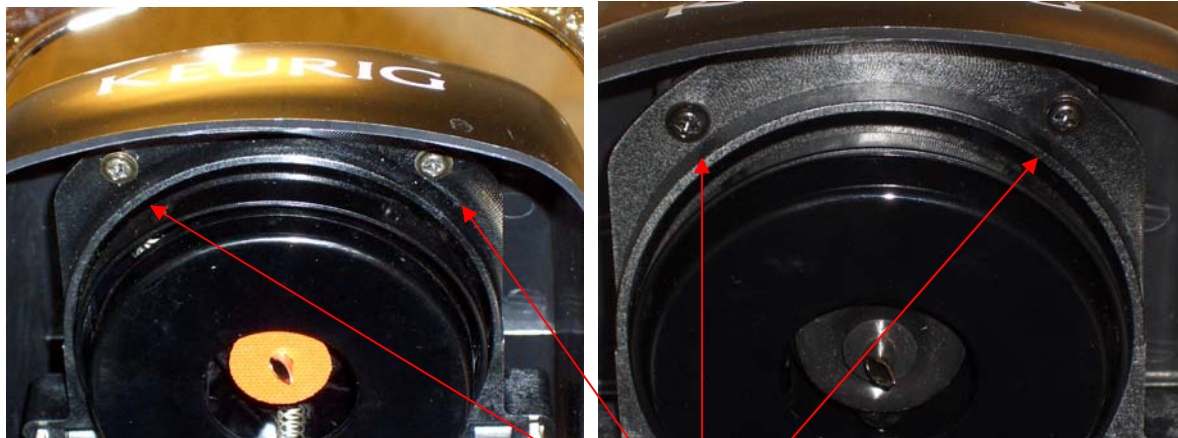
### C. PUNCTURE MECHANISM MODULE (Located in the top front portion of the brewer)

See **REMOVAL of OUTER PANELS (page 36)**. After completion of panel removal, the technician must attach an **ESD** wrist strap to themselves and the metal base plate of the brewer.



1. Disconnect the Hot Water Valve tube from the top of the **Bottom** Hot water tank. This hose is on the right hand side of the brewer looking at the front of the brewer.

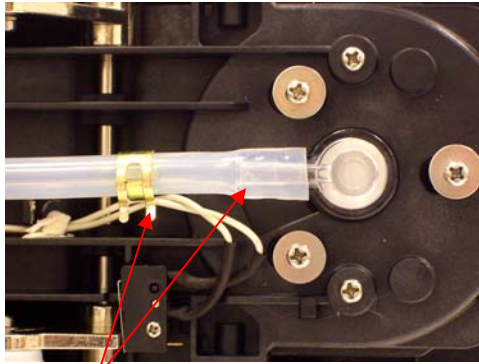
**Looking at the front of the brewer,**



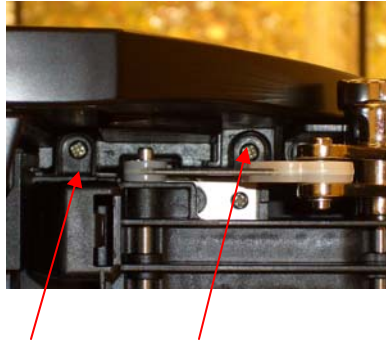
**BREWERS ≤ 7505**

**BREWERS ≥ 7506**

2. Raise the Puncture Mechanism handle and locate the two screws that hold the Puncture Mechanism cover in place.
3. Remove these screws.
4. Push the cover back slightly and lift up to remove.

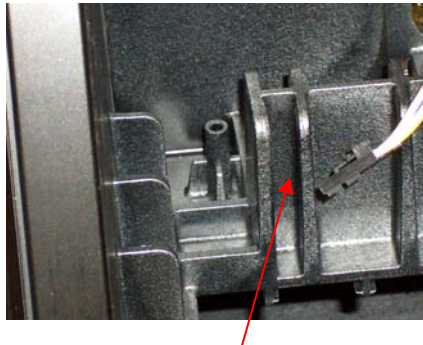


5. Release the hose clamp and remove the brew tube from the entrance needle assembly.

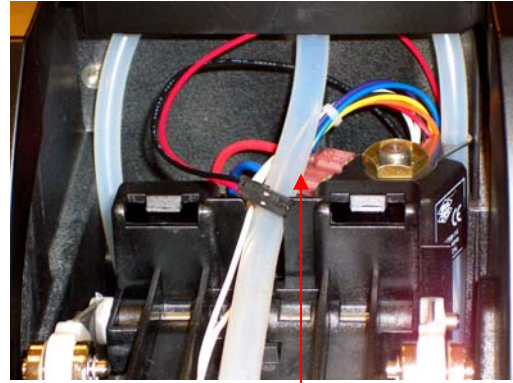
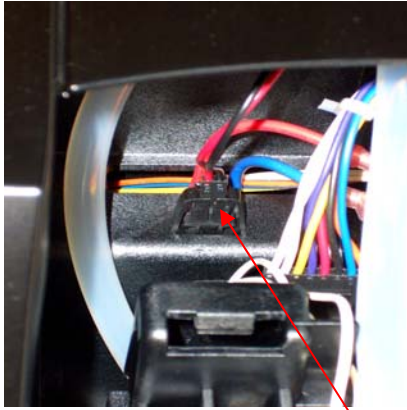


6. Loosen the four screws that hold the puncture module in place. There are two on each side. They are captive screws so they will NOT come out completely.

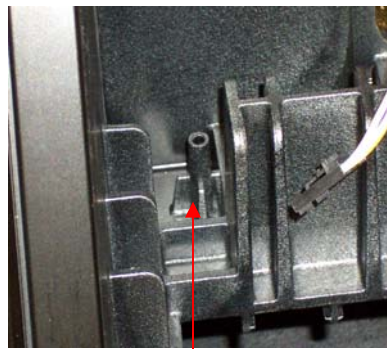
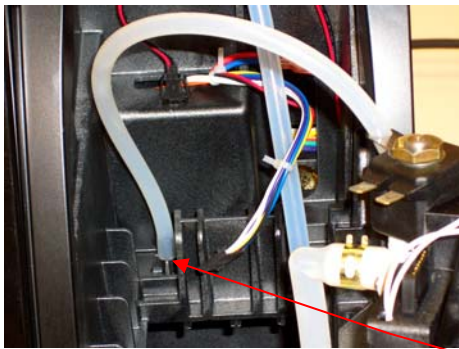
**Looking toward the back of the Puncture Mechanism Module area**



7. Lift the Puncture Mechanism Module straight up about 2 inches (50mm) to disengage the unit from a support mount. Support the module with your hand.



8. Disconnect the multi colored wire harness located to the left of the Hot Water Valve and the two wires on the Hot Water Valve solenoid. There is no polarity for these wires.



9. Disconnect the Vent tube from the venting nipple on the left hand side of the module area.
10. The Puncture Mechanism Module can now be removed from the brewer.

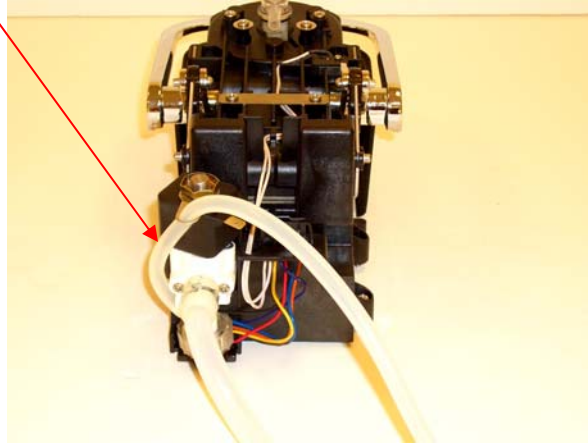
**NOTE:** When reinstalling the new module connect the Hot Water Vent hose to the vent nipple **FIRST**, and then connect the wire harness and two solenoid wires before you place the module on its support post making sure that they are secure and tight. Reconnect the remaining hoses.

11. Conduct a BIT test (see appendix VII on page 85) to insure the proper function of the brewer.

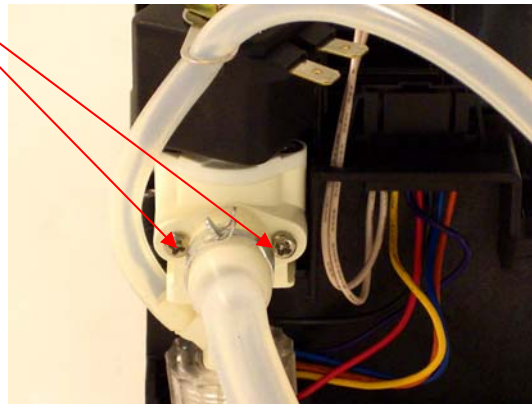
**D. HOT WATER VALVE ASSEMBLY** (Located at the back of the Puncture Mechanism)

See **REMOVAL of OUTER PANELS** (page 36). After completion of panel removal, the technician must attach an **ESD** wrist strap to themselves and the metal base plate of the brewer. See **REMOVAL of PUNCTURE MECHANISM** (page 41).

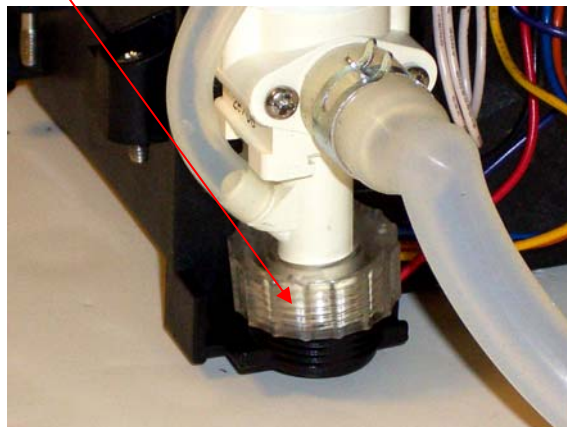
1. Locate the Hot Water Valve on the back of the Puncture Mechanism.



2. Remove the two self tapping Phillips screws.

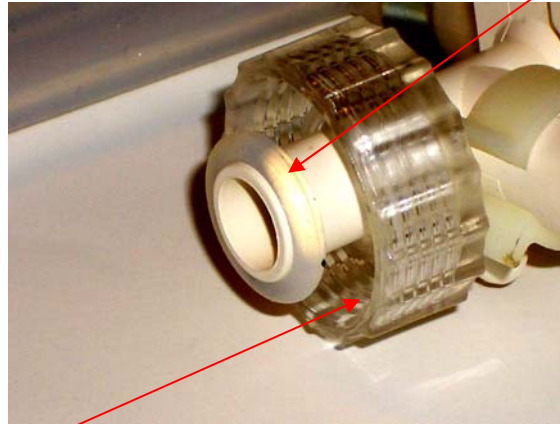


3. Loosen the large plastic nut at the bottom of the valve assembly.



4. Gently pull **OUT** and **UP** the valve assembly.
5. Reinstall the new valve.

**NOTE:** When reinstalling the new valve, you **MUST** make sure that the “**O**” ring on the bottom of the outlet tube is in place.



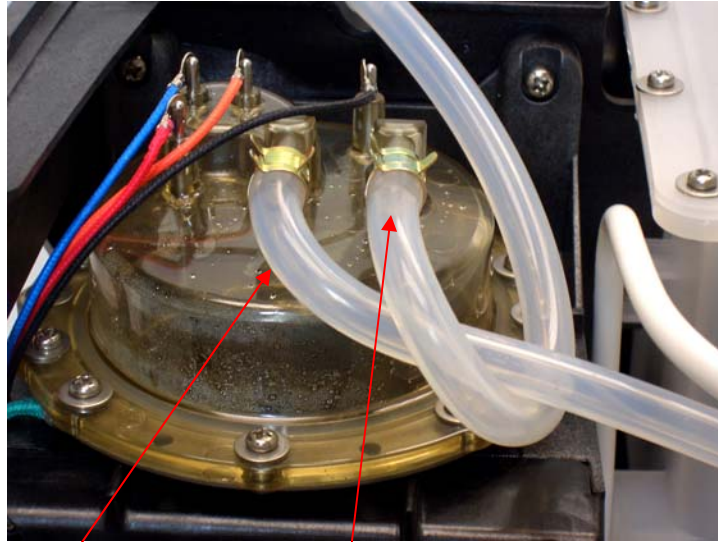
**NOTE:** The large **Plastic Nut** must be tight. Failure to do so will cause a leak when the hot water feature is selected.

6. Conduct a BIT test (see appendix VII on page 85) to insure the proper function of the brewer.

## E. HOT WATER TANK MODULE (Located in the back right side of brewer)

See **REMOVAL of OUTER PANELS (page 36)**. After completion of panel removal, the technician must attach an **ESD** wrist strap to themselves and the metal base plate of the brewer.

**NOTE:** Before disconnecting the two hoses on top of the module, make a note of where they are attached. The **LEFT** hose comes from the Cold Water Tank. The **RIGHT** hose goes to the Puncture Mechanism Module. These hoses **MUST** be reinstalled correctly. If they are not, then there will be no water dispensed during the brew cycle. Needle nose pliers can be used to release the two hose clamps that secure these hoses. Care must be taken when removing these clamps so that damage to these hoses does not occur.



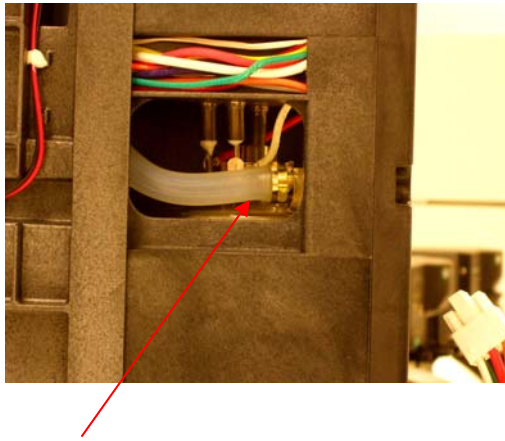
TO COLD WATER TANK

TO PUNCTURE MECHANISM

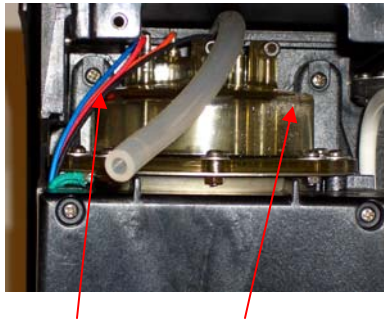
1. Disconnect the two hoses on the top Hot Water Tank.



2. Disconnect the two wire harness connections on the right side of the Hot Water Tank module.



3. Disconnect the Hot Water Valve hose from the top of the bottom tank.



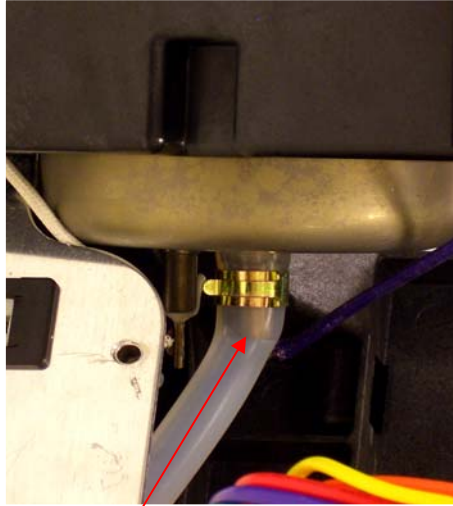
4. Locate the two screws at the top of the module. Loosen them fully. These are **captive** screws so they will **NOT** come out completely.



5. Tilt the module toward you. It is secured on the bottom with mounting tabs. Lift the module out carefully.



6. Remove the nut (6mm) securing the green ground wire on the left hand side of the Power Module.



7. Disconnect the hose from the bottom tank.
8. The Hot Water Tank Module can be removed from the brewer.
9. Install the new module and connect all of the appropriate connections, hoses, and wires making sure that they are secure and tight.
10. Conduct a BIT test (see appendix VII on page 85) to insure the proper function of the brewer.

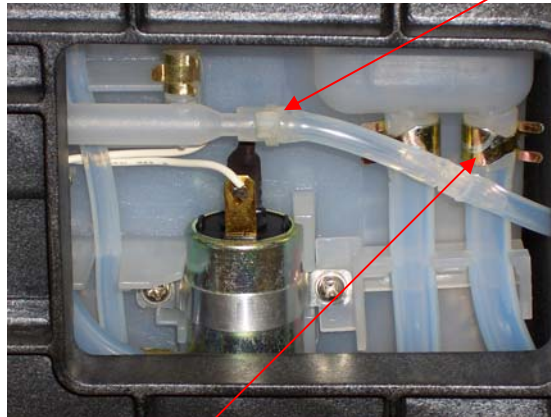


## F. COLD WATER TANK MODULE (Located at the top right of the brewer)

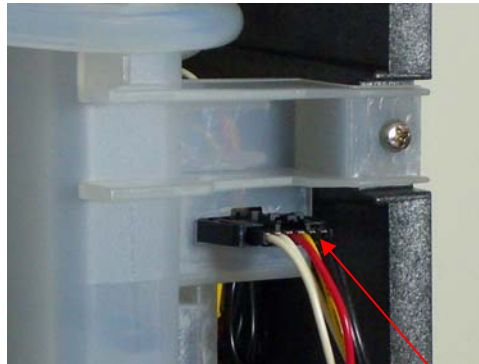
See **REMOVAL of OUTER PANELS (page 36)**. After completion of panel removal, the technician must attach an **ESD** wrist strap to themselves and the metal base plate of the brewer.

Looking at the right side of the brewer, take note of the cutout in the chassis near the top. You will see one small hose and two larger ones.

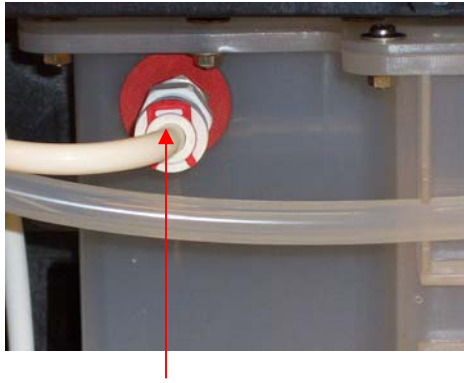
1. Disconnect the small hose from the filter tee, just above the vent valve.



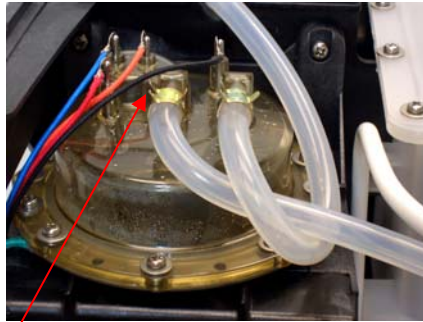
2. Disconnect the larger hose on the right.



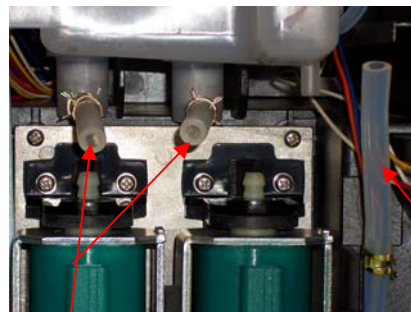
3. Looking from the back of the brewer disconnect the multi colored wire harness that connects to the right side of the Cold Water Tank.



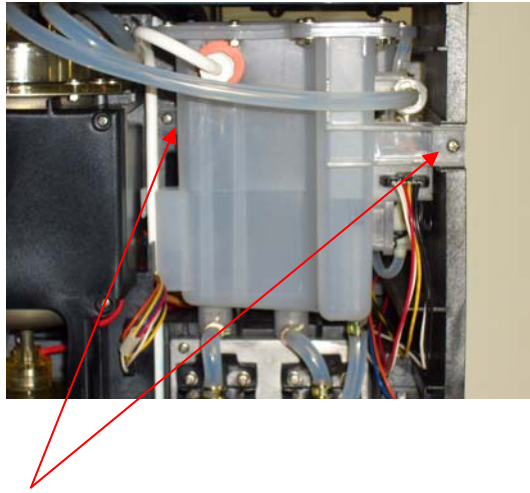
4. Remove RED retaining clip from Murdock fitting. This is a quick release tube connection. Push in on the collar, and pull out the tube.



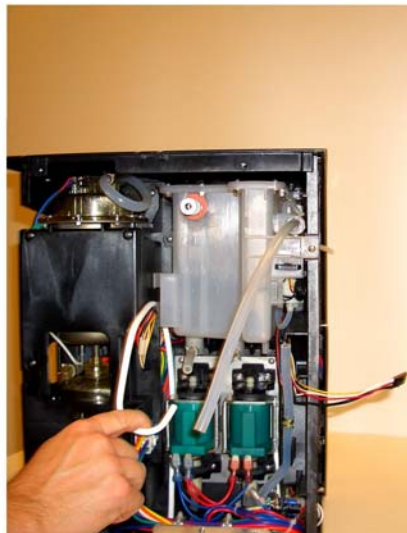
5. Release clamp and disconnect the hose on the LEFT side of the top Hot Water Tank.



6. Disconnect the hoses on the top of each of the water pumps.
7. Disconnect the Cold Water Tank drain hose on the bottom right side of the tank.



8. Loosen fully the two screws that secure the Cold Water Tank to the chassis. They are **captive** screws so they will **NOT** come out completely.

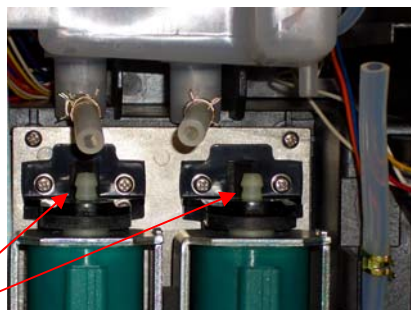
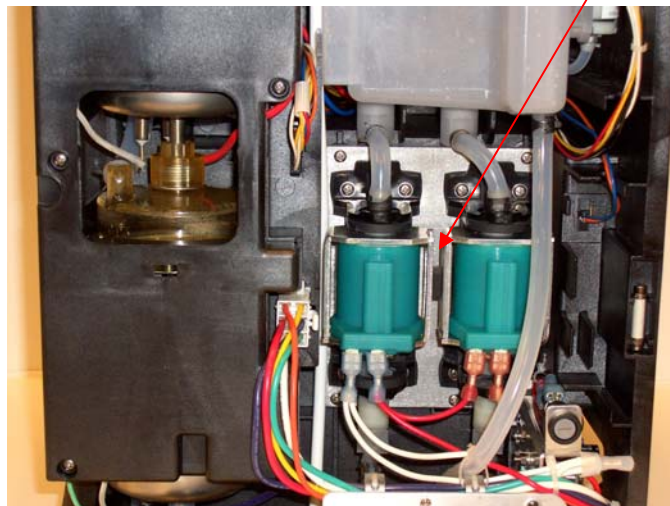


9. While gently holding the plastic tube from the Inlet Valve out of the way, remove the Cold Water Module.
10. Install the new module; connect all of the appropriate connections, hoses and wires making sure that they are secure and tight.
11. Conduct a BIT test (see appendix VII on page 85) to insure the proper function of the brewer.

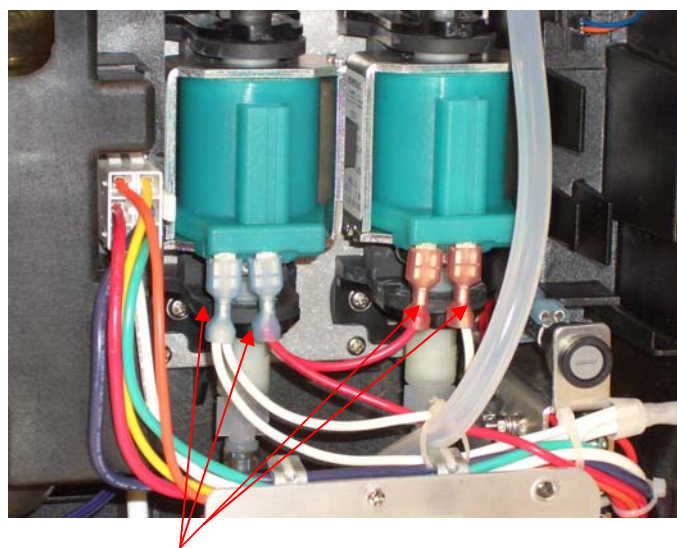
## G. COLD WATER PUMP MODULE (Located in the middle of the brewer)

See **REMOVAL of OUTER PANELS (page 36)**. After completion of panel removal, the technician must attach an **ESD** wrist strap to themselves and the metal base plate of the brewer.

Looking at the rear, in the middle of the brewer you will see the Cold Water Pump module.



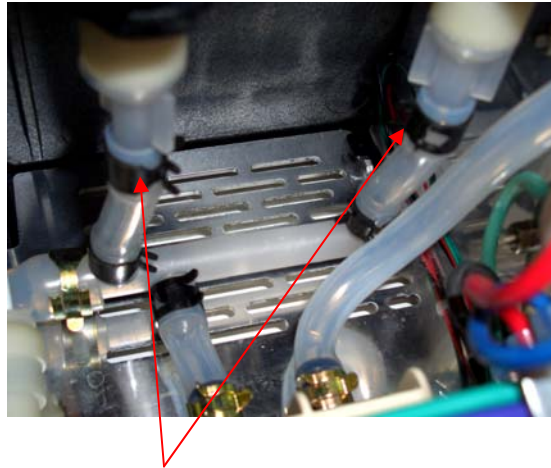
1. Disconnect the hose on the top of each pump, two places.



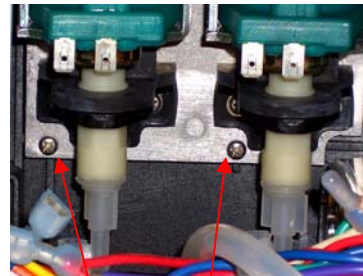
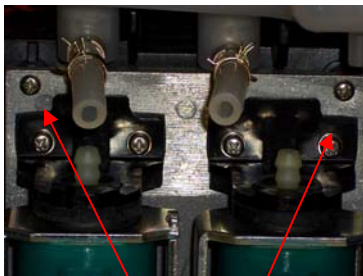
2. Prior to disconnecting the four wire connections attached to bottom of the green water pumps make a note of their respective connections.

**NOTE: The wires must be reconnected to their proper connections when installing the new module. Failure to do so will result in having extremely noisy pumps while they are in operation. Make sure that Cold Water Tank drain hose is NOT pinched when reassembling.**

3. Disconnect these four wires.
4. Loosen the captive screws holding the Power Module in place. (page 36) Gently slide out the module. This will allow access to the manifold clips.



5. Disconnect the clamps and water hoses attached to the water manifold.
6. Remove the Multi Connector Tee manifold from new module. Set this aside. It will be used when installing a new Power Module that does not come with this connection.



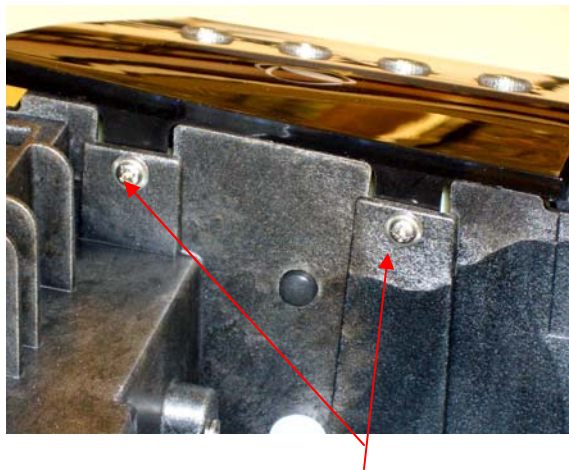
7. Locate the four screws holding the module to the chassis. Fully loosen these screws while holding the CWP module. They are **captive** screws so they will **NOT** come out completely.
8. The Cold Water Pump Module can be removed from the brewer.
9. Install the new module and connect all of the appropriate connections, hoses, and wires making sure that they are secure and tight.
10. Conduct a BIT test (see appendix VII on page 85) to insure the proper function of the brewer.

## H. CONTROL PANEL MODULE (Located on the left front of the brewer)

**CAUTION:** The technician must attach an ESD wrist strap to themselves and the metal base plate of the brewer or earth ground when replacing this module.

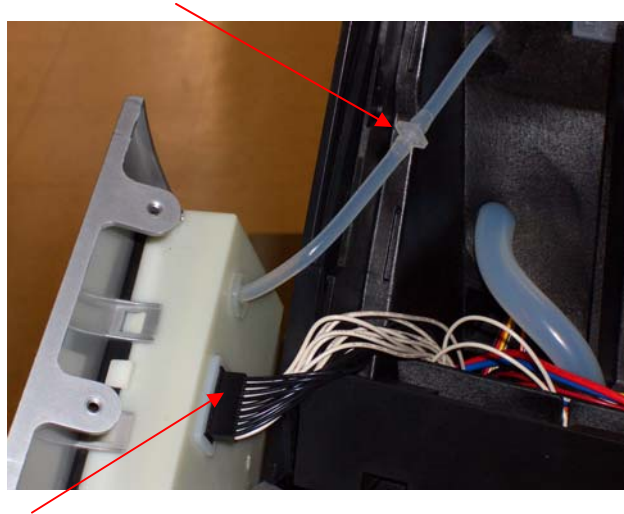


1. Open the K-Cup Bin door.



2. Tip the brewer back slightly and locate the two screws under the Control Panel. Remove these screws completely.
3. Gently pull out and up on the module to remove from the brewer.
4. Look at the back of the Control Panel module, you will see the wire harness connector and a hose union.

5. Disconnect the small tube at the union connection.

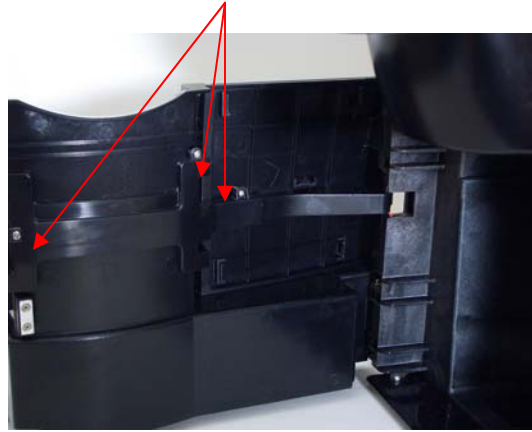


6. Disconnect the wire harness connection.
7. The Control Panel Module can now be removed.
8. Install the new module and connect all of the appropriate connections, hoses, and wires making sure that they are secure and tight.
9. Conduct a BIT test (see appendix VII on page 85) to insure the proper function of the brewer.

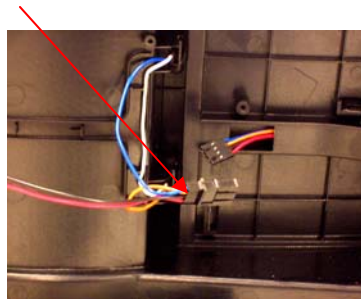
**I. FRONT DOOR MODULE** (Located at the bottom of the brewer in the front).

**NOTE:** To remove the Front Door Module you **MUST** first remove the Control Module screws and gently push the module up from the chassis to allow the TOP hinge pin to be removed. You do not need to remove the Control Module or disconnect any connections.

1. Open the K-Cup bin door. Locate the wire harness cover plate and the three screws that secure this cover



2. Remove the screws and cover plate.
3. Disconnect the cup sensor harness connection.



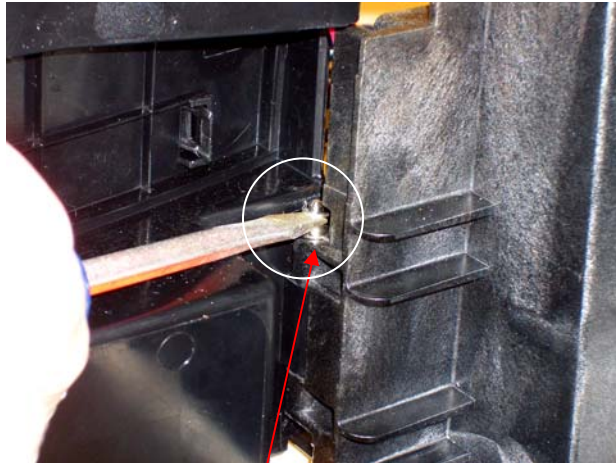
4. Open the Bin Door in order to remove the front decorative cover plate by releasing the plastic tabs on the back of the plate.

One of five tabs

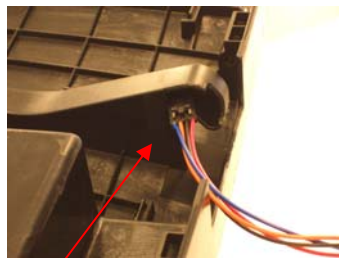




5. Locate the two hinge pins connecting the door to the brewer.



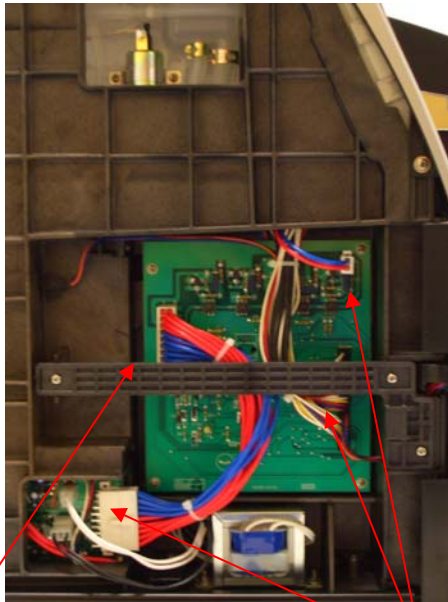
6. Using a flat screw driver, gently pry the hinge pins up and out.



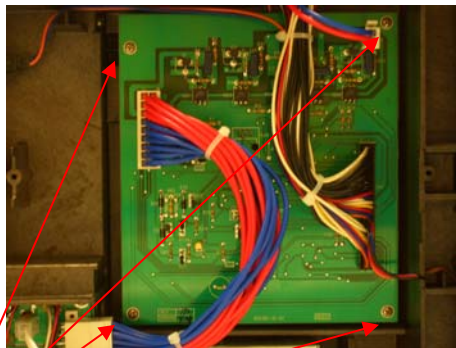
7. Carefully pull the wire harness through the opening.
8. The Door Module can now be removed.
9. Install the new module and connect the appropriate wire connection, cover plate and reinsert the hinge pins making sure that they are secure and tight.
10. Conduct a BIT test (see appendix VII on page 85) to insure the proper function of the brewer.

**J. MAIN PCB MODULE** (Located on the Left side of the brewer)

See **REMOVAL of OUTER PANELS (page 36)**. After completion of panel removal, the technician must attach an **ESD** wrist strap to themselves and the metal base plate of the brewer.



1. Remove the plastic bar in front of the Main PCB and disconnect the three wire harness connections on the board.



2. Remove the four screws holding the PCB to the chassis. Set the PCB aside.
3. The Main PCB can now be removed.
4. Install the new module and connect the appropriate wire connections, and reinstall the protective plastic bar.
5. Conduct a BIT test (see appendix VII on page 85) to insure the proper function of the brewer.

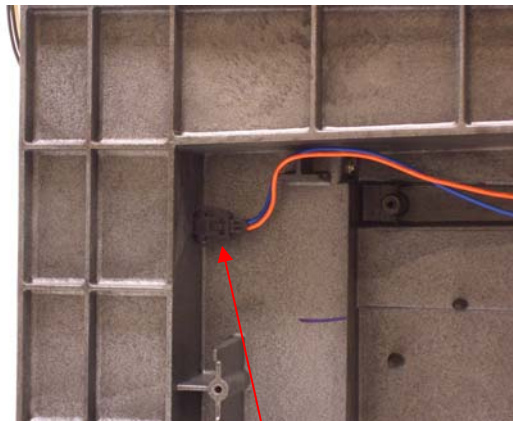
**K. BIN FULL SENSORS** (Located on each side of the of the K-Cup bin cavity)

See **REMOVAL of OUTER PANELS (page 36)**. After completion of panel removal, the technician must attach an **ESD** wrist strap to themselves and the metal base plate of the brewer. See **REMOVAL of MAIN PCB MODULE (page 58)**. After completion of PCB removal:

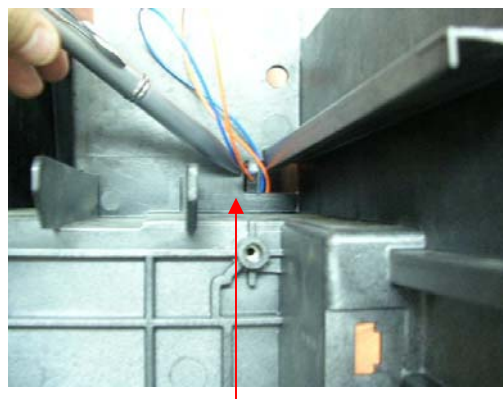
To remove the **LEFT** side LED, as you face the brewer.



1. Remove the screw holding the **LEFT** LED in place.

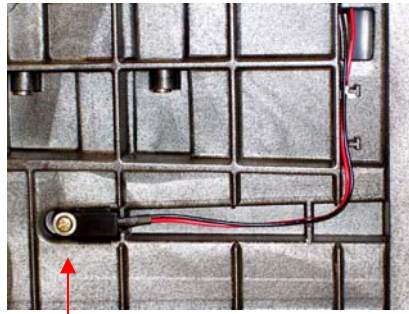


2. Disconnect the bin sensor. This connection is in the upper left corner of the main PCB area. Unclip the **MALE** end of the connection from the chassis by squeezing the retaining tabs together.



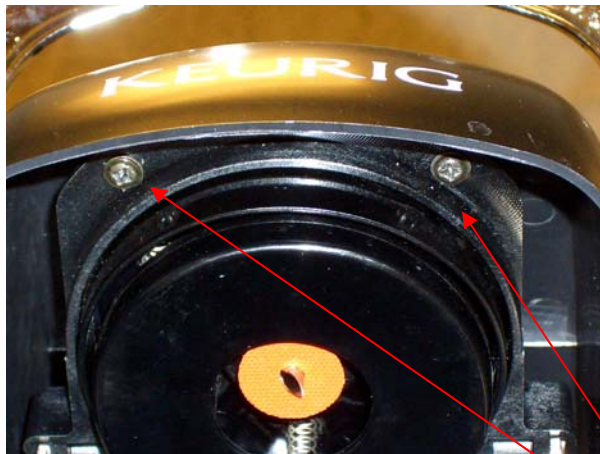
3. Carefully pull the **MALE** connector through the chassis opening behind the Cold Water Tank.

4. This completes the **LEFT** side bin sensor removal. Install the replacement sensor, the main PCB, and plastic bar. Make sure that all connections are tight.  
To remove the **RIGHT** side bin sensor

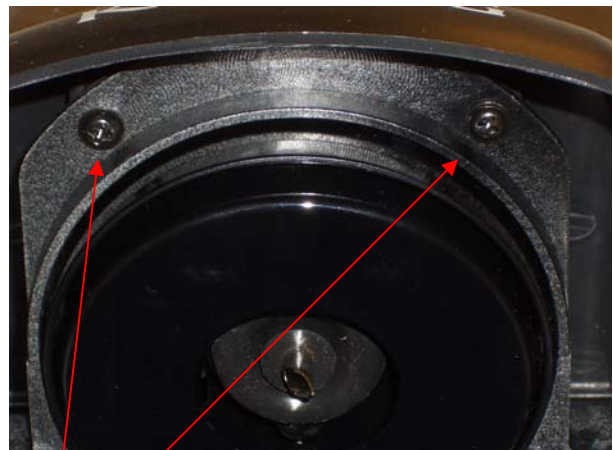


1. Remove the screw holding the **RIGHT** LED in place.

Looking at the front of the brewer,

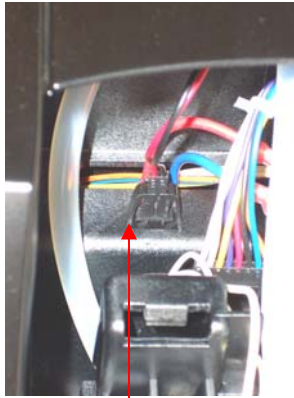


**BREWERS  $\leq$ 7505**

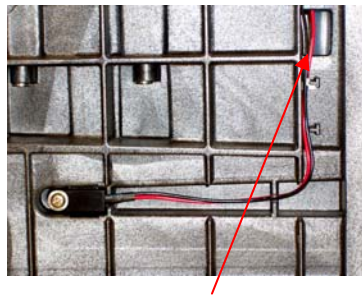


**BREWERS  $\geq$  7506**

2. Raise the Puncture Mechanism handle and locate the two screws that hold the puncture cover in place.
3. Remove these screws.
4. Push the cover back slightly and lift up to remove.



5. Disconnect the **SMALL** connector toward the back of the Puncture Mechanism module area. If it is easier, you can remove the Puncture Mechanism Module completely to gain access to this connector.



6. Carefully pull the wire through the opening in the chassis and remove the **RIGHT** side bin sensor.
7. This completes the **RIGHT** side bin sensor removal. Install the replacement sensor making sure that all connections are tight. Attach the Puncture Mechanism Module cover and tighten its retaining screws.
8. Conduct a BIT test (see appendix VII on page 85) to insure the proper function of the brewer.

## De-Scaling Your Brewer

Mineral content in water varies from place to place. Depending on the mineral content of the water in your area, calcium deposits or scale may build up in your brewer. Scale is nontoxic, but left unattended, it can hinder brewer performance. De-scaling your brewer helps maintain the heating element and other internal parts of the brewer that come in contact with water.

The brewer should be de-scaled every 6 months to ensure optimal performance. It is possible for calcium deposits to build up faster, making it necessary to de-scale more often.

This brewer is equipped with sensors to detect when scale buildup is interfering with the performance of the brewer. When this is detected, the brewer will alert you to perform a de-scaling procedure by generating one of the following messages.

- De-scale soon
- De-scale now

**NOTE: SAFETY GLASSES AND RUBBER GLOVES SHOULD BE WORN BEFORE PROCEEDING WITH THE DE-SCALING PROCEDURE.**

### 5. De-Scaling Procedures:

#### a) PREPARE

1. Make sure you have at least (80 ounces) of full strength citric acid such as CDCC Citric Acid Powder or similar product on hand. You will also need an empty sink and a ceramic cup (do not use a paper cup.) and a Flojet pump or similar.
2. Disconnect the brewer from the water supply and power it off. Drain both the hot and cold tanks.

#### b) FILL AND CLEAN

1. Enter the PRIME mode (enter Menu mode and answer YES to HAS BREWER BEEN DRAINED) and use a Flojet pump system to add de-scaling solution to the brewer.

**NOTE: The water temperature for dissolving the powder can not be greater than 110° F. Damage to the Flojet pump can occur.**

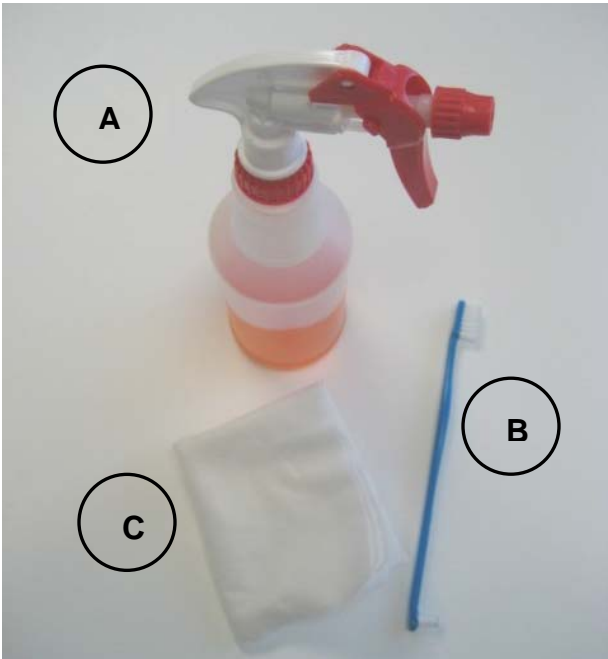
Complete the PRIMING process.

2. After it has primed and heated, place a ceramic cup in the Drip Tray and run a brew cycle. DO NOT USE A K-CUPP® Pportion pack, just press the Brew Button. Pour the contents of the cup into the sink.
3. Now let the brewer stand for at least one hour.
4. Repeat the brew process, without K-Cups® at least 10 times, pouring the contents of the cup into the sink after each cycle. We suggest using the largest brew size to speed the process. Remember to open and close the brew handle between each cycle so the blue Brew lights will flash.

5. Power off the brewer and drain both hot and cold water tanks.
6. Reconnect the brewer to the filtered cold water supply and follow the PRIME procedure to refill the brewer.
7. Once the prime process is complete, power off the brewer and drain both hot and cold water tanks again.
8. Power up the brewer and follow the PRIME procedure again, performing several (10) cleansing brews to remove any residual taste from the citric acid.

NOTE: If the LCD screen still alerts you to perform a de-scale after completing the procedure, repeat the de-scaling procedure.

## 6. Sanitizing / Cleaning the Puncture Mechanism (P.M.)



FOR PROPER SANITIZING / CLEANING OF THE PUNCTURE MECHANISM, THE FOLLOWING ITEMS ARE RECOMMENDED.

A. DISHWASHING LIQUID SOLUTION OR SOAP & WATER IN A SPRAY BOTTLE.

B. MINI SCRUB BRUSH FOR CRAMPED AND TIGHT AREAS [i.e. AS SHOWN, McMASTER-CARR PT NO. 7243T22].

C. CLOTH FOR WIPING.

D. ACCESS TO A SINK (IDEALLY WITH FRUIT SPRAYER) OR A BUCKET OF WATER FOR RINSING. SEE IMAGES 18 AND 19.

### A. Sanitizing/Cleaning the B3000 Inlet Needle and Gasket



1. DEPRESS NEEDLE PLATFORM TO EXPOSE INLET NEEDLE AND THE INLET NEEDLE GASKET. LOOK FOR TEARS OR OTHER NON FUNCTIONING CONDITIONS.



2. WHILE DEPRESSING THE PLATFORM REMOVE STUBBORN PARTICLES BY USING BRUSH AND WATER.



3. WIPE THE NEEDLE AND GASKET AREA CLEAN USING A DRY CLOTH. PERFORM THREE CLEANSING BREWS (BREWS WITHOUT K-CUPS) TO RINSE OUT NEEDLE.



## B. Sanitizing/Cleaning the Puncture Mechanism (P.M.)



1. P.M. REMOVED AS DESCRIBED IN THIS MANUAL.



2. REMOVE LOWER P.M. COVER BY REMOVING THE TWO SCREWS AS INDICATED ABOVE.



3. HERE THE P.M. IS SHOWN WITH THE LOWER P.M. COVER REMOVED.



4. TO REMOVE THE BOTTOM P.M. COVER, REMOVE THE THREE SCREWS INDICATED ABOVE.



5. HERE THE P.M. IS SHOWN WITH THE BOTTOM P.M. COVER REMOVED.



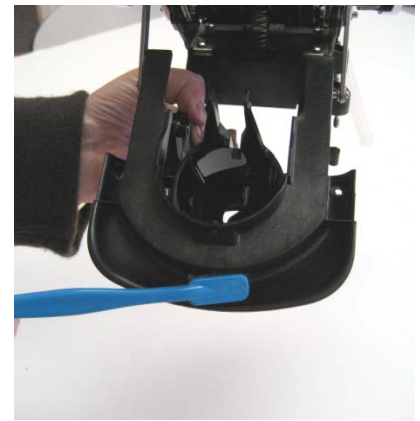
6. THE K-CUP HOLDER, LOWER RIGHT, SHOULD BE REMOVED AND SANITIZED AS DESCRIBED IN THE USE & CARE GUIDE ON PAGE 12.



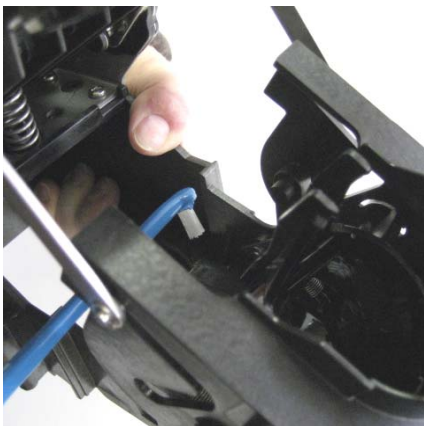
7. THE MODULE FRAME SHOULD BE SPRAYED WITH A SOAPY SOLUTION OR MILD DETERGENT.



8. THE MODULE CAN BE MANEUVERED SO ALL AREAS CAN BE REACHED BY THE SPRAY.



9. USE SMALL SCRUB BRUSH TO REMOVE DEBRIS FROM THE MODULE.



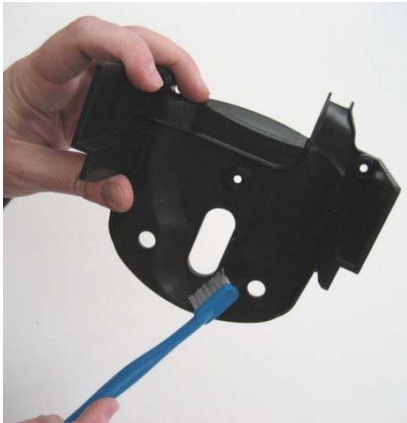
10. USE THE DETAILING END OF THE BRUSH TO REACH INSIDE THE MODULE FRAME TO REMOVE DEBRIS.



11. A CLOTH CAN BE USED TO WIPE THE FRAME CLEAN AND TO DRY IT AFTER RINSING UNDER A FAUCET, OR RINSING WITH A FRUIT SPRAYER, OR RINSING IN A BUCKET OF WATER.



12. USE THE SAME SPRAY ON THE UNDER COVER.



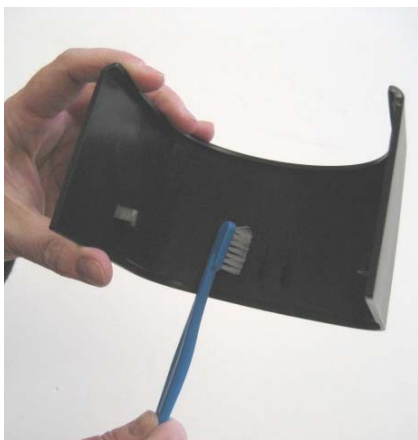
13. USE THE SCRUB BRUSH ON THE UNDER COVER AS NECESSARY.



14. USE A CLOTH WIPE AS REQUIRED. RINSE UNDER FAUCET OR IN BUCKET OF WATER.



15. PREP THE LOWER P.M. COVER WITH CLEANING SPRAY.



16. BRUSH PART AS NECESSARY.



17. WIPE THE PART WITH A CLOTH AS NECESSARY. RINSE UNDER FAUCET OR IN A BUCKET OF WATER.



18. RINSE FRAME IN BUCKET OF WATER IF AVAILABLE, TAKING CARE NOT TO WET ELECTRICAL COMPONENTS.



19. REMOVE FRAME FROM BUCKET ALLOWING WATER TO DRAIN.



20. MODULE CAN BE PLACED ON TOWEL TO ALLOW FOR FINAL DRAINING BEFORE WIPING.



21. RE-ASSEMBLE MODULE TO BE RE-INSTALLED IN BREWER.

## **IV. Product Warranty Information**

### **WARRANTY**

Set forth below is a summary of warranty information for your Keurig B3000 brewer effective as of the date the Service Manual was printed. The complete details of Keurig's warranty is set forth in the Non-Exclusive Distributorship Agreement, as amended from time to time, between Keurig and the original purchaser of this Brewer.

Keurig warrants that your Keurig B3000 Brewer will be free of defects in materials or workmanship under normal use for one year from the date of delivery to the original purchaser. Keurig will, at its option, repair or replace the Brewer without charge upon its receipt of proof of such delivery date. If a replacement Brewer is necessary, the replacement Brewer may be new or reconditioned. If a replacement Brewer is sent, it will carry the remaining warranty of the original product. Keurig will cover all shipping costs for authorized warranty returns.

This warranty only applies to Brewers operated in the United States and Canada. This warranty gives you specific legal rights, and you may also have other rights that vary from state to state and, in the case of Canada, from Province to Province.

### **LIMITED WARRANTY**

**THIS WARRANTY DOES NOT COVER CONSEQUENTIAL OR INCIDENTAL DAMAGES SUCH AS PROPERTY DAMAGE AND DOES NOT COVER INCIDENTAL COSTS AND EXPENSES RESULTING FROM ANY BREACH OF THIS WARRANTY, EVEN IF FORSEEABLE.** Some states or Provinces do not allow the exclusion or limitations of incidental or consequential damages, so the above limitation or exclusion may not apply to you depending on the state or Province of purchase.

THIS WARRANTY IS EXCLUSIVE AND IN LIEU OF ANY OTHER EXPRESS WARRANTY, WHETHER WRITTEN OR ORAL. THE DURATION OF ANY IMPLIED WARRANTIES, INCLUDING BUT NOT LIMITED TO ANY IMPLIED WARRANTIES OF MERCHANTABILITY OR FITNESS FOR A PARTICULAR PURPOSE, IS EXPRESSLY LIMITED TO THE PERIOD OF DURATION OF THIS LIMITED WARRANTY. Some states or Provinces do not allow limitations on how long an implied warranty lasts, so the above limitation may not apply to you depending on the state or Province of the purchase.

### **OTHER WARRANTY EXCLUSIONS**

The limited warranty set forth above shall not apply to any Brewer, and Keurig shall have no obligation under such warranty or otherwise, under any of the following circumstances:

- The Brewer is repaired or attempted to be repaired with replacement parts that have not been purchased from or approved by Keurig;
- The Brewer is improperly or negligently installed, repaired, modified or operated, including, but not limited to operation of the Brewer without an Ominpure KQ8 or equivalent water filtration system;
- The Brewer is abused or neglected, including, but not limited to, failure to clean or remove mineral deposit accumulations periodically from the Brewer in accordance with Keurig user or service instructions or manuals;
- The Brewer is damaged in transit to Keurig due to improper packaging; or
- The Brewer is damaged after delivery from Keurig to the original purchaser or its agent, as applicable.

## **OBTAINING WARRANTY SERVICE**

Keurig Brewers are high quality appliances and, with proper care, are intended to provide years of satisfying performance. However, should the need arise for warranty service, simply call Keurig Field Support at our toll free number 1-888-CUP-BREW (1-888-287-2739). Please do not return your brewer for servicing without first speaking to Keurig Field Support to obtain an Authorization to Return number (ATR). Keurig brewers returned without an ATR number will be returned to the sender, at the sender's expense, without servicing.

## **V. Certifications and Specifications**

### **Regulatory Compliance**

The Keurig B3000 Brewer will comply with:

#### **UL 197**

Commercial Electric Cooking Appliances

#### **ANSI / NSF 25 (applies to brewers F0009546 and higher)**

Commercial Cooking, Rethermalization, and Powered Hot Food Holding and Transport Equipment.

#### **CAN/CSA C22.2 No. 109 – M1981**

Commercial Cooking Appliances

#### **NAMA Listed**

National Automatic Merchandising Association

### **Specifications**

<b>Size.....</b>	<b>12 Inches W X 21.3 Inches D X 17.5 Inches H 305 mm W X 540 mm D X 443mm H</b>
<b>Weight.....</b>	<b>35 Pounds Empty (Shipping Weight 38 Pounds) 15.88 kilograms Empty (Shipping Weight 17.24 kilograms)</b>
<b>Tank Volumes.....</b>	<b>Hot Water Tank, 1400 ml Hot Water Tank, 47.34 oz Cold Water Tank, 450 ml Cold Water Tank, 15.22 oz</b>
<b>Brew Sizes.....</b>	<b>4 oz, 6 oz, 8 oz or 10 oz 118 ml, 177 ml, 236 ml or 296 ml</b>
<b>Electrical.....</b>	<b>125 VAC, 60 Hz, 15 Amp, Three Prong Plug, 1400 Watts</b>
<b>Plumbing.....</b>	<b>3/4 Inch Male Garden Hose Fitting</b>
<b>Water Supply Pressure.....</b>	<b>40 to 125 psi 0.03 kg/mm<sup>2</sup> to 0.08 kg/mm<sup>2</sup></b>

## VI. ACCESSORIES APPENDIX

### 1. Water Filter Kit (Part Number 5025)



Keurig requires the use of a water filtration system for the B3000. The Omnipure KQ8A filter is recommended. This filter has both a Charcoal filter medium for removing chlorine, taste and odor, plus phosphate for the reduction of lime build up inside the brewer.

**NOTE: The phosphate only slows down the build up of lime. It does not eliminate it.**

Keurig offers a filter kit for its brewers. The kit (Part Number 5025) contains:

- 1 – Omnipure KQ8A filter
- 1 – Filter head
- 1 – Mounting bracket with screws

There is no water connection components provided in this kit. The type of connectors used to attach the water supply to the filter is left up to the distributor.



## 2. Coin Changer Accessory (Part Number 5557)

The installation of the B3000 Coin Changer Accessory is covered in the installation guide provided with each coin changer accessory kit. Details for the installation of the changer are provided as an appendix of this manual. If a copy is needed, asked for part number 60-200814-000.

### Introduction:

This guide will detail how to install the coin mechanism that will enable coin operation of the Keurig B3000 Commercial Brewer. This guide is intended for Keurig authorized distributors (KADs). The guide covers attaching the B3000 Coin Changer Accessory to the brewer and installing the coin mechanism inside the B3000 Coin Changer Accessory. The coin mechanism covered in this installation guide is the COINCO Quantum Pro XXQ-G700 Series. The mechanism is shown below. The use of a coin mechanism is determined and acquired by a KAD. For details regarding the operation and components of the coin mechanism, please refer to the manufacturer's user manuals.



## The B3000 Coin Changer Accessory:

The B3000 Coin Changer Accessory is custom designed to be used exclusively with the B3000 Commercial Brewer and the aforementioned coin mechanism. All the necessary hardware and cables for assembling the B3000 Coin Changer Accessory are included. See figures 1 and 2. The items included in the accessory kit are:

1. Coin changer cabinet
2. Brewer coin platform
3. High capacity platform
4. Brewer-cabinet plate
5. Accessory package
  - A. Screws 5 ea.
  - B. Control cable
  - C. Keys 2 ea.



Figure 1

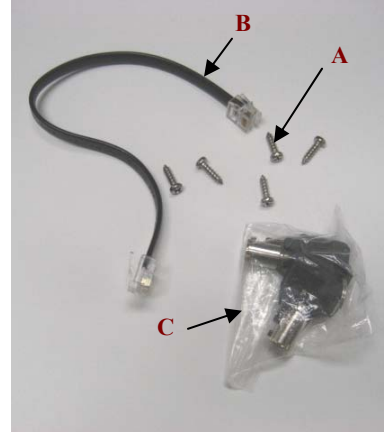


Figure 2

### Procedure for Attaching the Coin Changer Accessory to the Brewer: (Without a Platform Unit)

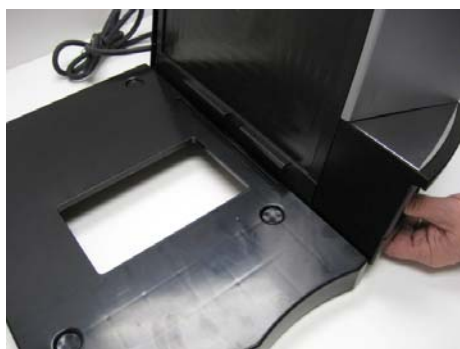
The step by step procedure for attaching the coin changer accessory is as follows:

1. Place brewer platform on cabinet top where brewer will be in service. See Figure 3 below.



Figure 3

2. Join the coin changer cabinet to platform by placing the 'hooks' inside the platform slot. See figures 4 and 5 below.



**Figure 4**



**Figure 5**

3. Place brewer on the platform such that the rubber feet of the brewer fit into the detent areas on the platform and the brewer rests on top of the coin changer cabinet protrusions. See figure 6 below.



**Figure 6**

4. At the rear of the assembled brewer-coin changer cabinet locate the five holes for mounting the Brewer-cabinet plate. Remove the five screws from the plastic accessory bag. See figure 7 below.



**Figure 7**

5. Fasten the brewer-cabinet plate to the cabinet (three screws) and to the brewer (two screws). See figures 8 and 9 below.



**Figure 8**



**Figure 9**

6. Connect the control cable to both RJ11 connectors on the rear of the brewer and the coin changer cabinet. See figure 10 below.



**Figure 10**

## Installing the Coin Mechanism:

The step by step procedure for installing the coin changer is as follows:

1. Unlock the coin changer cabinet fascia [Figure 11] and remove it by lifting up at coin retrieval opening [Figure 12]. Remove the top panel of the coin changer cabinet by unscrewing the two screws at the rear of the unit [Figure 13] and sliding the panel rearward and lifting up.



Figure 11



Figure 12



Figure 13

2. Mount and connect the coin mechanism.



Figure 14

Locate the mounting screws of the cabinet shown in fig 14.



Figure 15

Slide coin mechanism back into the cabinet insuring the cabinet mounting screws locate into the holes at the back of the unit shown in fig 15. Note, some changers may require a slight deflection of the cabinet side panels during insertion.



Figure 16

Once the coin mechanism is seated properly connect the unit to the connector as shown and route cord as shown in fig 16.



Figure 17

Replace the top panel. When mounted properly the coin mechanism should have a flush look and feel as shown in fig 17.

3. Tightening the Mounting Screws. See Figures 18 and 19 below. The mechanism is shown outside of the coin accessory cabinet.



**Figure 18**

To tighten the mounting screws on the Quantum Pro device the upper panel must be opened. To open the panel depress the tab and pull back on the coin slot to rotate the panel toward you and down.



**Figure 19**

Once the panel is rotated down the screws will be exposed for tightening. After tightening rotate the panel up and back until it snaps closed.

4. Load coins in the coin changers as appropriate. Please refer to the respective unit's manual for direction on how to load coins.

## Procedure for Setting the Brewer to Coin Operation:

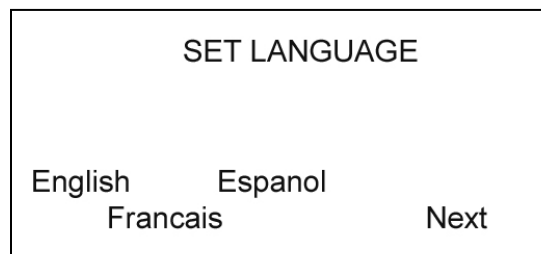
Procedure:

1. Attach coin changer unit to brewer per assembly instructions.
2. Connect patch cable to female RJ11 connectors on the back of the B3000 brewer and the coin unit.
3. Plug-in each units cords to outlets.
4. Power both units. Switches are located on the rear bottom of both units.
5. To enable the coin changer unit, access the menu button through the front door of the B3000 brewer. The menu button is located inside the brewer at the top (see figure 1). Press the menu button 4 times within 4 seconds after powering the brewer to access the menu.

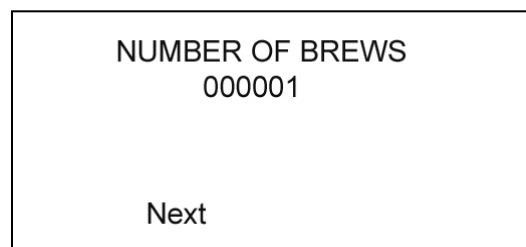


Figure 1

6. Once the menu is accessed the display will look like this (set language):

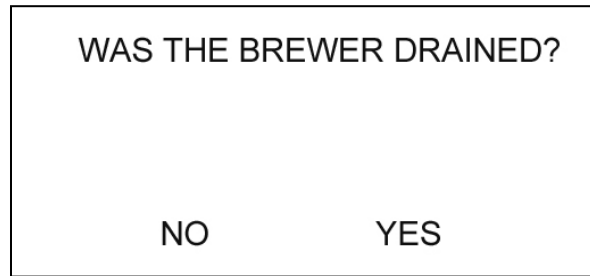


7. Press the 'Next' button.
8. The display will look like this (number of brews):



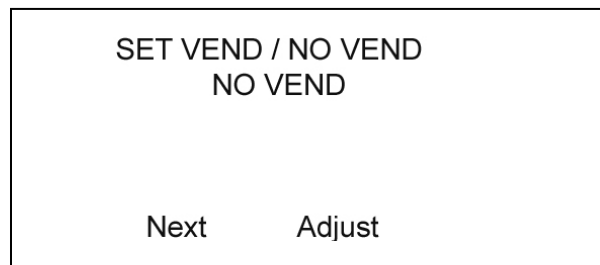
9. Press the 'Next' button.

10. The display will look like this (was brewer drained):



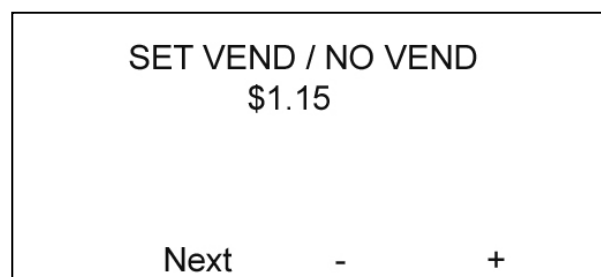
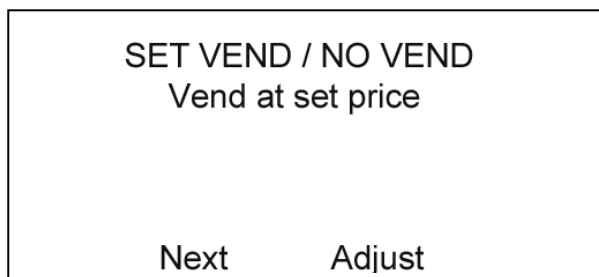
11. Press the 'Yes' or 'No' button as appropriate.

12. The display will look like this (set vend / no vend):



13. Press 'Adjust' button to 'Vend at Set the price' (image on left below). Then press next button.

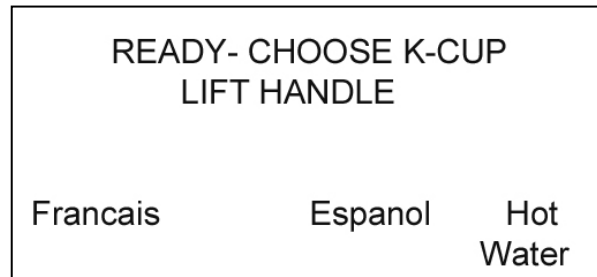
14. The display will look like the image on the right below. Adjust price by pressing the + or - button to get desired price. Adjustments are in \$0.05 increments.



15. Press the 'Next' button after selection is made.



16. The next display will read 'Set the Brew Temp' at the display continue to press the next button until the following display is seen, and then the brewer and coin changer unit are ready for operation.



**WARNING:** The product should be connected to a branch circuit protected at maximum 20A.

**DANGER:** Risk of electric shock. This unit has two power supply cords. Disconnect all power before installing coin or credit mechanism.

**CAUTION:** Risk of Fire or Electric Shock. Only operate this appliance with Coin Changer Mechanism, Coin Acceptors Inc. Model Quantum Pro XXQ-G700 Series in Place.

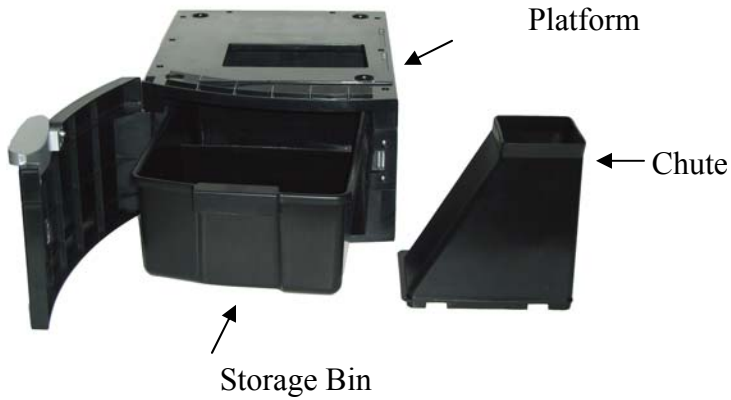
**DANGER:** For Data Connection with Coffee Maker B3000 only. Do not connect to public telephone network.

Only use with Keurig Model B3000 Commercial Coffee Maker.

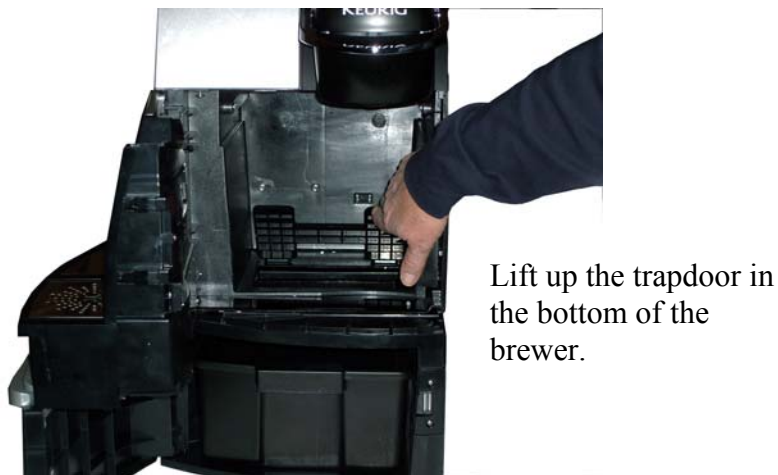
Suitable for indoor use only.

### 3. Platform Unit (Part Number 5558)

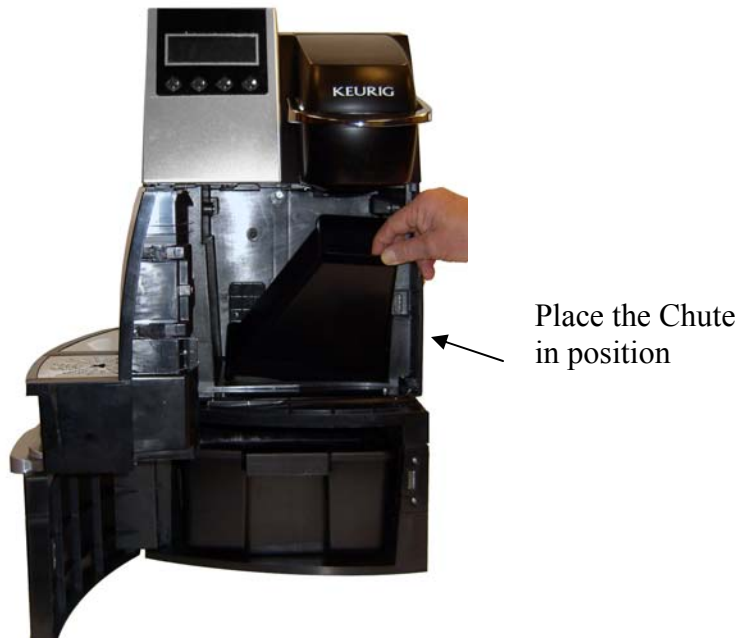
The assembly of the B3000 Platform accessory is covered in the installation guide provide with each platform kit. Details for the installation of the changer are provided as an appendix of this manual. If a copy is needed, ask for part number 60-200993-000.



**Fig 1. Contents of the Platform Kit #5558**



**Fig 2. Brewer placed on platform**



**Fig 3. Install Chute**



**Fig 4. Chute in position**



**Fig 5. Completed assembly**

## **VII BIT Testing**

### **Manufacturing Built In Test (BIT)**

The B3000 brewer has the ability of performing diagnostic tests to verify if most of the critical system elements are functioning properly. For brewers from **1 – 7505** see page 85. For brewers **7506 and above** see page 89.

To initiate the B3000 BIT, follow the procedure below:

- Start with an empty, cold brewer
- While powered off; Press and hold the Menu Button
- Turn power on (Hard Power)
- Release the Menu Button
- Press the Center Left Button 4 times within 2 seconds of applying power

#### ***Notes:***

- The top line of the display shows:
  - The test number
  - The tested component / instructions
- The second line of the display shows:
  - The most likely module bad, if fail.  
For example  
01: LEFT SW & LED  
MODULE: CTRL-PCB
- If any test fails the criteria, BIT will halt at that failed test number
- Ensure that the Entrance Needle is blocked before the start of the test with a pressure gauge. If not, BIT cannot advance beyond Test No. 22.
- These test fixtures are required:
  - Plug in coin IF loop back plug. (Figure 1) (Use P/N 03-200922-000 for ordering)
  - Ampere meter for power. (optional, can ignore current draw check)
  - Entrance needle blocker with pressure gauge. (optional, can use a piece of plugged tubing)
  - Coin interface loop-back plug (short transmit to receive) (optional, can stop at this test)
  - Vent clamp (optional, can use finger to block tube opening)
  - Inlet valve plug (optional, can use normal water hook-up)
- Note that after a few passes of the BIT, the brewer will be too warm to pass the temperature sanity check.

BIT loops on the last test forever. Power down to continue.



Figure 1.  
Modified RJ11 cable for coin unit test

TEST No. (TN)	TESTS:	INDICATIONS “LCD MESSAGE” / BUTTON LEDES	NOTES	ACTION TO CONTINUE
1.	Left Button / LED, LCD Pixels mostly on	“01: LEFT SW & LED?” “MODULE: CTRL-PCB” Left LED blinks	Check left LED, LCD mostly on	Check mostly lit pixels. Press Left Button
2.	Center Left Button / LED	“02: CTR-LEFT SW & LED?” “MODULE: CTRL-PCB” C Left LED blinks	Check center left LED	Press Center Left Button
3.	Center Right Button/ LED	“03: CTR-RIGHT SW & LED?” “MODULE: CTRL-PCB” C Right LED blinks	Check center right LED	Press Center Right Button
4.	Right Button / LED	“04: RIGHT SW & LEDES?” “MODULE: CTRL-PCB” R LED blinks	Check right LED	Press Right Button
5.	Muglight	“05: MUG LEDES?” “MODULE: M-PCB, BR-HEAD” R LED blinks	Check Mug light on	Press Right Button
6.	Door Switch (Open)	“06: OPEN HANDLE” “MODULE: BR-HEAD”		Raise the Handle
7.	Door Switch (Close)	“07: CLOSE HANDLE” “MODULE: BR-HEAD”		Lower the Handle
8.	Water Sensor (water level high)	“08: FLIP BREWER OVER” “MODULE: CWT”		Flip brewer over
9.	Water Sensor (water level low)	“09: FLIP BREWER BACK” “MODULE: CWT”		Flip brewer back
10.	Mug Sensor (blocked)	“10: BLOCK MUG” “MODULE: SENSORS”		Block Mug
11.	Mug Sensor (unblocked)	“11: UNBLOCK MUG” “MODULE: SENSORS”		Unblock Mug
12.	Bin Sensor (blocked)	“12: BLOCK BIN” “MODULE: SENSORS”		Block Bin
13.	Bin Sensor (unblocked)	“13: UNBLOCK BIN” “MODULE: SENSORS”		Unblock Bin
14.	K-Cup® Sensor (blocked)	“14: OPEN KCUP” “MODULE: BR-HEAD”	Done by opening the	Raise the handle

15.	K-Cup® Sensor (unblocked)	“15: CLOSE KCUP” “MODULE: BR-HEAD”	door. Ejection blocks sensor!!	Lower the handle
16.	Brew tank Thermistor @ ambient temperature	“16: BREW TEMP” “MODULE: HWT”		Auto Cont. if OK
17.	Pre-heat tank Thermistor @ ambient temperature	“17: PREHEAT TEMP” ” MODULE: HWT”		Auto Cont. if OK
18.	120 Hz Clock (60 Hz Power)	“18: 120 HZ CLOCK” “MODULE: M-PCB”		Auto Cont. if OK
19.	Heaters off	“19: HEATER LOW AMP?” “MODULE: POWER” R LED blinks		Press Right Button if less than 1 amp
20.	Brew Tank Heating Element power	“20: BREW 12A?” “MODULES: POWER, HWT” R LED blinks	Heating Element on for 3 seconds – Verify 12A	Press Right Button if OK, Center Right to repeat
21.	Preheat Tank Heating Element power	“21: PRE 12A?” “MODULES: POWER, HWT” R LED blinks	Heating Element on for 3 seconds – Verify 12A	Press Right Button if OK, Center Right to repeat
22.	Initial Air Pressurization with Water Pump, Pressure transducer	“22: CW PUMP. CLAMP&PSI-M” “MODULE: CWP, C-PCB, LEAK” R LED blinks	CWP on for 2 seconds. Verify >0.25 psi	Clamp CWT vent tube, add pressure gauge. Press Right Button when ready.
23.	Vent Valve opening under low pressure	“23: VV OPEN LO-PSI” “MODULE: CWT”	Vent Valve open for 2 seconds – Verify <0.1 psi	Auto Continue if OK
24.	Full HWT air Pressurization with Brew Pump. Pressure transducer calibration	“24: BREW PUMP 7PSI?” “MODULE: CWT, LEAKS” R LED blinks if 7psi	Runs Brew Pump until 7 psi. Checks pressure drop below .21 psi (7 psi - 3%) over 5s. If pass, R LED lights.	Press Right Button when lit and gauge at 7 psi
25.	Half CWT Pressurization by sharing; Vent Tubes Vent Valve opening under full over pressure	“25: VV OPEN HI-PSI” “MODULE: CWT”	Opens VV. (tanks equalize) Wait 5 seconds – check for pressure 3-5 psi.	Auto Continue if OK
26.	CWT, Vent Tubes Leaks	“26: CWT LEAK” “MODULE: CWT, LEAKS”	Checks pressure drop below .21 psi (4 psi) 5% over 5 seconds	Auto Continue if OK

27.	HW Dispense valve	“27: HWD VALVE” “MODULE: BR-HEAD”	Open VV. Open HWDV. Verify HWT <0.1 psi after 2 seconds	Auto Continue if OK
28.	Transmit and receive a “1” and “0” through the coin IF	“29: VEND I/F LOOPBACK” “MODULE: M-PCB, PWR-PANEL”		Auto Continue if OK
29.	Done	“30: PASS, !!!!” “DONE”	Power off	Stop

Test 24 pressurizes the entire hot water part of the brewer, thus checking for leaks in:

- All vent line components from the tank through the VV. Tested open in 25
- The HWT
- All fill line components from the HWT through the CWP. Tested open in 22
- All brew line components. Not tested open

Test 25 pressurizes the cold water part of the brewer, thus checking for leaks in:

- The vent line from the CWT to the bin. Not tested open
- The CWT
- The tube from the CWT to the CWP. Tested open in 22
- The inlet valve and high pressure tubing. (to 4 psi) Tested open in 28

Some components are not tested. The functionality was tested by manufacturing.

- Float valve
- CWT and HWT drains open
- Dispense line from Dispense Valve to Mug
- TCOs opening and TCO sensors
- Conductive probes and power
- Inlet Valve
- Hi-Pot

The coin IF loopback plug shorts the transmit to receive pin (RJ11 pins 3 and 4).



Bit Test for brewers **7506 and above**

TEST NO.	TESTS:	INDICATIONS “LCD MESSAGE” / BUTTON LEDES	NOTES	ACTION TO CONTINUE
1.	Left Button / LED, LCD Pixels mostly on	“01: LEFT SW & LED?” “MODULE: CTRL- PCB” Left LED blinks	Check left LED, LCD mostly on	Check for mostly lit pixels. Press Left Button
2.	Center Left Button / LED	“02: CTR-LEFT SW & LED?” “MODULE: CTRL- PCB” C Left LED blinks	Check center left LED	Press Center Left Button
3.	Center Right Button/ LED	“03: CTR-RIGHT SW & LED?” “MODULE: CTRL- PCB” C Right LED blinks	Check center right LED	Press Center Right Button
4.	Right Button / LED	“04: RIGHT SW & LEDS?” “MODULE: CTRL- PCB” R LED blinks	Check right LED	Press Right Button
5.	Mug-light	“05: MUG LEDES?” “MODULE: M-PCB, BR-HEAD” R LED blinks	Check Mug-light on	Press Right Button
6.	Door Switch (Open)	“06: OPEN HANDLE” “MODULE: BR-HEAD”		Raise the Handle
7.	Door Switch (Close)	“07: CLOSE HANDLE” “MODULE: BR-HEAD”		Lower the Handle
8.	Water Sensor (water level high)	“08: FLIP BREWER OVER” “MODULE: CWT”		Flip brewer over
9.	Water Sensor (water level low)	“09: FLIP BREWER BACK” “MODULE: CWT”		Flip brewer back
10.	Mug Sensor (blocked)	“10: BLOCK MUG” “MODULE: SENSORS”		Block Mug
11.	Mug Sensor (unblocked)	“11: UNBLOCK MUG” “MODULE: SENSORS”		Unblock Mug
12.	Bin Sensor (blocked)	“12: BLOCK BIN” “MODULE: SENSORS”		Block Bin
13.	Bin Sensor (unblocked)	“13: UNBLOCK BIN” “MODULE: SENSORS”		Unblock Bin

14.	K-Cup Sensor (blocked)	“14: OPEN KCUP” “MODULE: BR-HEAD”	Done by opening the door. Ejection blocks sensor!!	Raise the handle
15.	K-Cup Sensor (unblocked)	“15: CLOSE KCUP” “MODULE: BR-HEAD”		Lower the handle
16.	120 Hz Clock (60 Hz Power)	“16: 120 HZ CLOCK” “MODULE: M-PCB”		Auto Cont. if OK
17.	PT Sanity check	“17: LOW PRESSURE CHECK” “MODULE: CTRL-PCB”	Ambient pressure <0.25	Auto Cont. if OK
18.	Initial Air Pressurization with Water Pump, Pressure transducer	“18: CW PUMP. CLAMP&PSI-M” “MODULE: CWP, C-PCB, LEAK” R LED blinks	CWP on for 2 seconds. Verify >0.25 psi	Clamp CWT vent tube, add pressure gauge. Press Right Button when ready.
19.	Vent Valve opening under low pressure	“19: VV OPEN LO-PSI” “MODULE: CWT”	Vent Valve open for 2 seconds – Verify <0.1 psi	Auto Continue if OK
20.	Full HWT air Pressurization with Brew Pump. Pressure transducer calibration	“20: BREW PUMP 7PSI?” “MODULE: HWT, LEAKS”	Runs Brew Pump until 7 psi. Checks pressure drop below .21 psi (7 psi - 3%) over 5s. If pass,	Auto Continue if OK
21.	Half CWT Pressurization by sharing; Vent Tubes Vent Valve opening under full over pressure	“21: VV OPEN HI-PSI” “MODULE: CWT”	Opens VV. (tanks equalize) Wait 5 seconds – check for pressure 2-5 psi.	Auto Continue if OK
22.	CWT, Vent Tubes Leaks	“22: CWT LEAK” “MODULE: CWT, LEAKS”	Checks pressure drop below .21 psi (4 psi - 5%) over 5 seconds	Auto Continue if OK
23.	HW Dispense valve	“23: HWD VALVE” “MODULE: BR-HEAD”	Open VV. Open HWDV. Verify HWT <0.1 psi after 2 seconds	Auto Continue if OK
24.	Brew tank Thermistor @ ambient temperature	“24: BREW TEMP” “MODULE: HWT”		Auto Cont. if OK
25.	Pre-heat tank Thermistor @ ambient temperature	“25: PREHEAT TEMP” ” MODULE: HWT”		Auto Cont. if OK
26.	Heaters off	“26: HEATER LOW AMP?” “MODULE: POWER” R LED blinks		Press Right Button if less than 1 amp

27.	Brew Tank Heating Element power	“27: BREW 12A?” “MODULES: POWER, HWT” R LED blinks	Heating Element on for 3 seconds – Verify 12A	Press Right Button if OK, Center Right to repeat
28.	Preheat Tank Heating Element power	“28: PRE 12A?” “MODULES: POWER, HWT” R LED blinks	Heating Element on for 3 seconds – Verify 12A	Press Right Button if OK, Center Right to repeat
29.	Transmit and receive a “1” and “0” through the coin IF	“29: VEND I/F LOOPBACK” “MODULE: M-PCB, PWR-PANEL”		Auto Continue if OK
30.	Done	“30: PASS, !!!!” “DONE”	Power off	Stop

Test 20 pressurizes the entire hot water part of the brewer, thus checking for leaks in:

- All vent line components from the tank through the VV. Tested open in 19
- The HWT
- All fill line components from the HWT through the CWP. Tested open in 21
- All brew line components. Not tested open

Test 21 pressurizes the cold water part of the brewer, thus checking for leaks in:

- The vent line from the CWT to the bin. Not tested open
- The CWT
- The tube from the CWT to the CWP. Tested open in 18
- The inlet valve and high pressure tubing. (to 4 psi) Not tested open

Some components are not tested:

- Float valve
- CWT and HWT drains open
- Dispense line from Dispense Valve to Mug
- Thermostats opening and Thermostat sensors seeing opens
- Conductive probes and power
- Inlet Valve
- Hi-Pot
- The second CWP

The coin IF loop back plug shorts the transmit to receive pin (RJ11 pins 3 and 4).

### VIII. REVISION CONTROL

REVISION	ECN #	ISSUED BY	RELEASE DATE	REASON FOR CHANGE
A	254	DAM	DEC 18, 2006	INITIAL RELEASE
B	499	DAM	JULY 5, 2007	<ul style="list-style-type: none"> <li>• Modification to CWT</li> <li>• Modification to HWT (TCO placement)</li> <li>• Modification to Puncture Mechanism</li> <li>• Modification to K-Cup Holder</li> <li>• Change to lever-less design for drains</li> <li>• Revise Fuse Holder on power module</li> <li>• Add detailed Puncture Mechanism cleaning instructions</li> <li>• Add removal/replacement instructions for Hot Water Dispense Valve</li> <li>• Document changes between S/N 1 -7505 &amp; 7506 &amp; up</li> <li>• Account for software upgrade</li> </ul>
C	637	SFL	NOV 30, 2007	<ul style="list-style-type: none"> <li>• Updated replacement parts</li> </ul>

## Free Manuals Download Website

<http://myh66.com>

<http://usermanuals.us>

<http://www.somanuals.com>

<http://www.4manuals.cc>

<http://www.manual-lib.com>

<http://www.404manual.com>

<http://www.luxmanual.com>

<http://aubethermostatmanual.com>

Golf course search by state

<http://golfingnear.com>

Email search by domain

<http://emailbydomain.com>

Auto manuals search

<http://auto.somanuals.com>

TV manuals search

<http://tv.somanuals.com>