



ECI500-C

TREADMILL

OWNER'S MANUAL

Model Name _____

Serial Number _____

Purchase Date _____

Write down for future reference.

Keys Technical Service, (888) 340-0482

KEYS Fitness Products, LP

P.O. Box 551239

Dallas, Texas 75239

keysfitness  **com**

Information Page #

Table of Contents	2
Specification Sheet	3
Important Safety Information	4
Before You Start	5
Warm Up Exercises	6
Assembly, Moving Instructions	7
Power Requirements	8
Console Functions and Descriptions	9
Program and Operating Instructions	10 & 11
Program Descriptions and Profiles	12
Belt Adjustments and Tension	13
Change to MPH or Km/H	14
Troubleshooting Guide	15
Parts and Diagrams	16
Parts List	17
Warranty Registration (Mail In Form)	18

◆ Horsepower (Continuous)	2.5hp
◆ Display Type	5 Window LCD
◆ Electronics	One touch
◆ Pre-Set Programs	3
◆ Custom Programs	6
◆ User Programs	0
◆ Heart Rate Interactive	No
◆ Power Incline	12%
◆ Roller Diameter	1.9"
◆ Cushioned Deck	Yes
◆ Speed Range	0-10mph
◆ Belt Size	18 x 51"
◆ Front Hand Rails	Yes
◆ Side Hand Rails	Yes
◆ Foot Print	29 x 62"
◆ Foot Print Folded	29 x 29"
◆ Warranty Motor	10 Years
◆ Warranty Parts	2 Years
◆ Warranty Labor	2 Year

- 1) **WARNING!** Before using this treadmill or starting any exercise program, consult your physician. This is especially important for persons over the age of 35 and/or persons with pre-existing health problems. The manufacturer or distributor assumes no responsibility for personal injury or property damage sustained by or through the use of this product.
- 2) **WARNING!** To reduce the risk of electrical shock, burns, fire, or other possible injuries to the user, it is important to review this manual and the following precautions *before* operation.

SAFETY PRECAUTIONS AND TIPS

- ◆ It is the owner's responsibility to ensure that all users of this treadmill have read the Owner's Manual and are familiar with warnings and safety precautions.
- ◆ This treadmill has a user maximum capacity of 275 pounds.
- ◆ The treadmill should only be used on a level surface and is intended for indoor use only. The treadmill should not be placed in a garage, patio, or near water and should never be used while you are wet. KEYS recommends a treadmill mat be placed under the treadmill to protect floor or carpet and for easier cleaning.
- ◆ Follow safety information in regards to plugging in your treadmill. Keep the power cord away from the incline wheels and do not run the power cord underneath your treadmill. Do not operate the treadmill with a damaged or frayed power cord.
- ◆ Wear comfortable, good-quality walking or running shoes and appropriate clothing. Do not use the treadmill with bare feet, sandals, socks or stockings.
- ◆ Always straddle the belt and allow it to start moving before stepping onto the belt.
- ◆ Hold on to handrails when adjusting speed, incline, or other controls.
- ◆ Always examine your treadmill before using to ensure all parts are in working order.
- ◆ Allow the belt to fully stop before dismounting.
- ◆ Pets should never be allowed near or on the treadmill.
- ◆ Do not leave children unsupervised near or on the treadmill.
- ◆ Never operate the treadmill where oxygen is being administered, or where aerosol products are being used.
- ◆ Never insert any object or body parts into any opening.
- ◆ For safety and to prevent damage to your treadmill, no more than one person should use the treadmill at a time.
- ◆ Always unplug the treadmill before cleaning and/or servicing. Service to your treadmill should only be performed by an authorized service representative, unless authorized and/or instructed by the manufacturer. Failure to follow these instructions will void the treadmill warranty.
- ◆ Never leave the treadmill unattended while it is running.

Thank you for purchasing a KEYS treadmill! This quality product you have chosen was designed to meet your needs for cardiovascular exercise.

Before you start, please read the Owner's Manual and become familiar with the operation of your new treadmill.

- ◆ Remember to take the time to perform the stretching exercises provided to avoid injury.
- ◆ Do not stand on the walking belt while pressing the Power button or Start/Stop button.
- ◆ Always adjust the speed of the treadmill in small increments as this treadmill is capable of high speeds.
- ◆ If you are taking medication, consult your physician to see if the medication will affect your exercise heart rate.
- ◆ If you have heart problems, you are not active, and/or are over the age of 35 years, do not use the pre-set treadmill programs or start an exercise program without first contacting and receiving approval from your physician.
- ◆ To avoid the risk of electrical shock, always keep the console dry. Do not spill liquids on the console. KEYS recommends a sealed water bottle for beverages consumed while using the treadmill.
- ◆ Please review the following drawing below to familiarize yourself with the listed parts. This manual covers several treadmills, so the one pictured below may not be identical to your particular model.

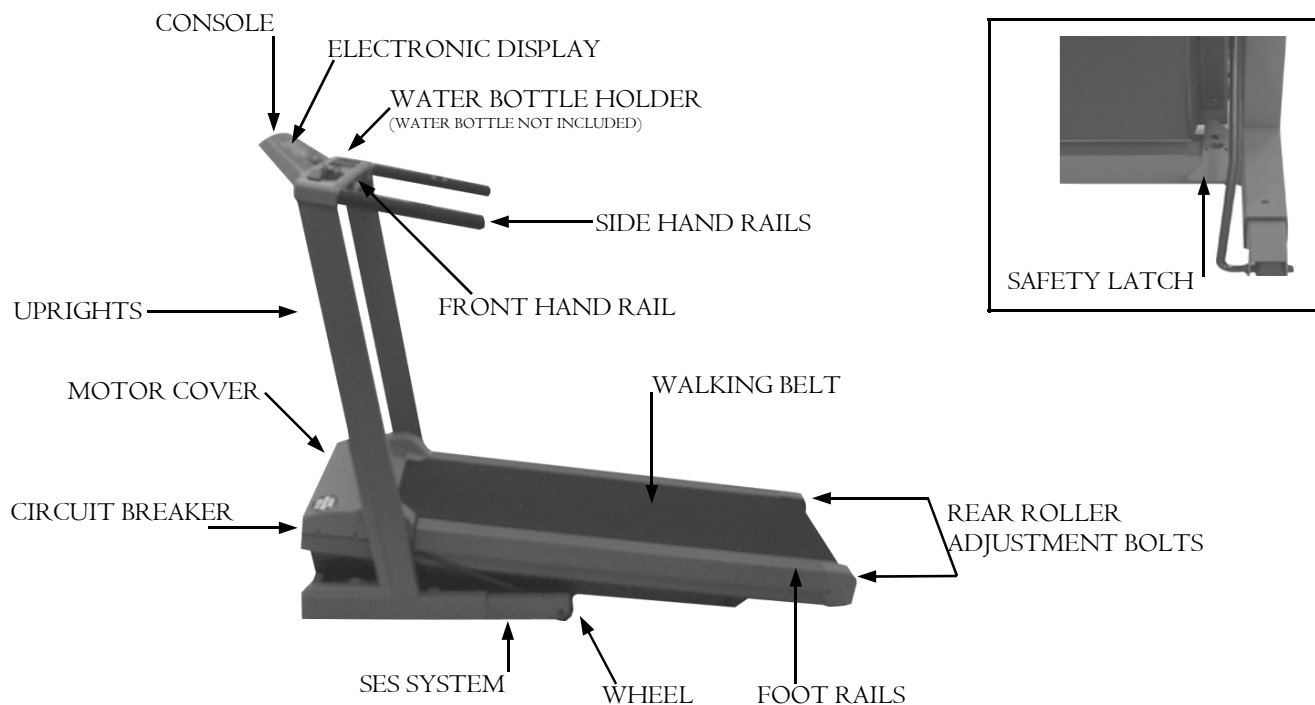

EXERCISE GUIDELINES

WARNING! Before beginning this or any exercise program, you should consult your physician. This is especially important for individuals over the age of 35 or individuals with pre-existing health problems.

Warming up prepares the body for the exercise by increasing circulation, supplying more oxygen to the muscles and raising body temperature. Begin each workout with 5 to 10 minutes of stretching and light exercise to warm up. The photos on this page show several forms of basic stretching you may perform before your workouts. In order to achieve an adequate warm-up, perform each stretch three times.

TOE TOUCH STRETCH

Stand bending your knees slightly and slowly bend forward from your hips. Allow your back and shoulders to relax as you reach down toward your toes as far as possible. Hold for 15 counts, then relax. This will stretch your hamstrings, back of knees, and back.



HAMSTRING STRETCH

Sit with one leg extended. Bring the sole of the opposite foot toward you and rest it against the inner thigh of your extended leg. Reach toward your toes as far as possible. Hold for 15 counts, then relax. This will stretch your hamstrings, lower back, and groin.



CALF/ACHILLES STRETCH

With one leg in front of the other, reach forward and place your hands against a wall. Keep your back leg straight and your back foot flat on the floor. Bend your front leg, lean forward and move your hips toward the wall. Hold for 15 counts, then relax. To cause further stretching of the Achilles tendon, bend your back leg as well. This will stretch your calves, Achilles tendons, and ankles.



QUADRICEPS STRETCH

With one hand against a wall for balance, reach back and grasp one foot with your other hand. Bring your heel as close to your buttocks as possible. Hold for 15 counts, then relax. This will stretch your quadriceps and hip muscles.



Assembly

This KEYS treadmill is shipped in one piece and fully assembled. After opening the box, remove any packing materials from the treadmill. Do not throw away any packing materials until the unit is working properly. Place the base on a clean, level surface. Make sure the electrical cord will easily reach an electrical outlet.

Moving

CAUTION! TO AVOID THE RISK OF INJURY, NEVER ATTEMPT TO MOVE THE TREADMILL WHILE IT IS IN THE UNFOLDED OPERATING POSITION. TO REDUCE THE POSSIBILITY OF INJURY WHILE LIFTING, BEND YOUR LEGS AND KEEP YOUR BACK STRAIGHT. AS YOU RAISE THE TREADMILL, LIFT USING YOUR LEGS, NOT YOUR BACK. IN ORDER TO RAISE OR LOWER THE TREADMILL SAFELY, YOU MUST BE ABLE TO LIFT 45 POUNDS (20KG). IT IS SUGGESTED YOU ALWAYS USE THE AID OF A SECOND PERSON WHEN MOVING THE TREADMILL.

With the treadmill in the folded locked position (safety latch is engaged), grasp the handrails and place one foot on the base as shown in the photo below. Next, with a firm grasp on the handrails, place one foot on the center of the base crossbar and carefully tilt the treadmill back until it rolls freely on the wheels. Using extreme caution, move the treadmill to the desired location. To set the treadmill down, place one foot on the center of the base crossbar and carefully lower treadmill onto base in resting position. Do not attempt to move the treadmill over an uneven or rough surface.



IMPROPER CONNECTION OF THE EQUIPMENT GROUNDING CONNECTOR CAN RESULT IN A RISK OF AN ELECTRIC SHOCK. CHECK WITH A QUALIFIED ELECTRICIAN OR SERVICE MAN IF YOU ARE IN DOUBT AS TO WHETHER THE PRODUCT IS PROPERLY GROUNDING. DO NOT MODIFY THE PLUG PROVIDED WITH THE PRODUCT, IF IT WILL NOT FIT THE OUTLET. HAVE A PROPER OUTLET INSTALLED BY A QUALIFIED ELECTRICIAN.

This treadmill can be seriously damaged by sudden voltage changes in your home's electrical power. Voltage spikes, surges, and noise interference can result from weather conditions or from other appliances being turned on or off. To reduce the possibility of treadmill damage, always use a surge protector (not included) with your treadmill.

Surge protectors can be purchased at most hardware stores. The manufacturer recommends a single outlet surge protector with UL 1449 rating as a Transient Voltage Surge Suppressor (TVSS) with UL suppressed voltage rating of 400V or less and an electrical rating of 120VAC, 15 amps.

This treadmill must be grounded to reduce the risk of electrical shock. Grounding provides a path of least resistance for electric current should the treadmill malfunction. This treadmill comes with an electrical cord with an equipment-grounding conductor and a grounding plug. Always plug the power cord into a surge protector, and plug the surge protector into an appropriate outlet that is properly installed and grounded in accordance with all local codes and ordinances.

This product is for use on a nominal 120-volt circuit and has a grounding plug that looks like the plug illustrated in the drawing below.

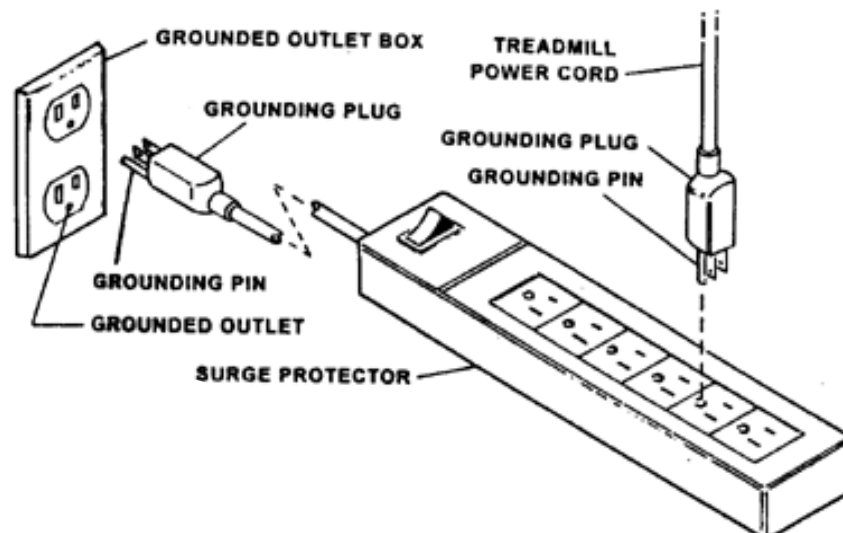

There are five display windows on the control panel to provide feedback information.

TIME WINDOW

- ◆ **TIME:** Indicates elapsed time after pressing start in minutes and seconds (0-99 minutes, 0-59 seconds)
- ◆ **INTERVAL TIME:** Indicates countdown in seconds to the next interval starting at 5 seconds and counting to 0 seconds

SPEED WINDOW

- ◆ **SPEED:** Indicates MPH (miles per hour) or KMH (kilometer per hour) in .1 increments

DISTANCE / CALORIES WINDOW

- ◆ **DISTANCE:** Indicates Miles or Kilometers traveled in .01 increments up to 9.99 and .1 increments starting at 10.0
- ◆ **CALORIES:** Indicates estimated calories used based on 150 lb. person at the indicated speed, incline, and time

INCLINE WINDOW

- ◆ **INCLINE:** Indicates incline in percent of grade 0-12% in 0.5 increments

CENTER BRICKYARD WINDOW

- ◆ Displays quarter mile track in Manual mode. Indicates position on track by a blink. In program mode, shows the change in speed profile across the interval range (1-10) and shows position with a blinking action.
- ◆ In Program mode, the treadmill will display the name of the program selected. This is shown on the left hand side of the window. In Manual mode, the LAP counter will appear in the top center of the window, counting each 1/4 mile lap in sequence of completion (1, 2, 3, etc.)

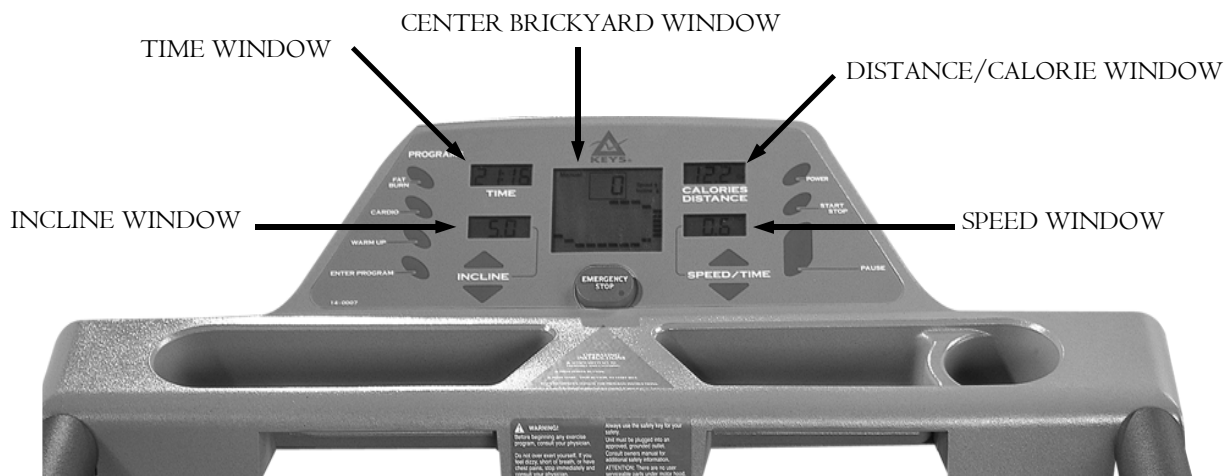

- ◆ QUICK START / MANUAL MODE
- ◆ Plug into a surge protector outlet. Attach **RED Safety Key** to treadmill console.
- ◆ Stand on the treadmill and straddle belt. Attach safety key clip to your clothes.
- ◆ Press POWER button. There will be an eight (8) second delay after pressing the POWER button before data can be entered. The TIME window will flash.
- ◆ Press START/STOP button. Belt will begin to move after 4 seconds. Step on belt slowly after the belt starts moving. Speed or incline may be adjusted by using the appropriate + (increase) or – (decrease) button.
- ◆ To end your workout, press START/STOP button. Belt will gradually slow to zero.
- ◆ To pause your workout, press PAUSE.
- ◆ To re-start after pausing: Press the PAUSE button. **WARNING: THE TREADMILL BELT WILL RESUME AT THE SPEED THE TREADMILL WAS MOVING BEFORE PAUSING.**
- ◆ **Countdown Time, Preset Speed and/or Incline:** Time, Speed, and Incline may be preset prior to getting started. After pressing the POWER button, the time window will blink. Use the SPEED/TIME + or – arrows to select your workout time, then press the ENTER PROGRAM button. The SPEED/TIME window will now be flashing. Using the same + or – arrows, select the speed for your workout, then press ENTER PROGRAM. Now the INCLINE window will be flashing. Use the INCLINE + or – arrows to set your workout incline, then press ENTER PROGRAM. To start, press the START/STOP button.

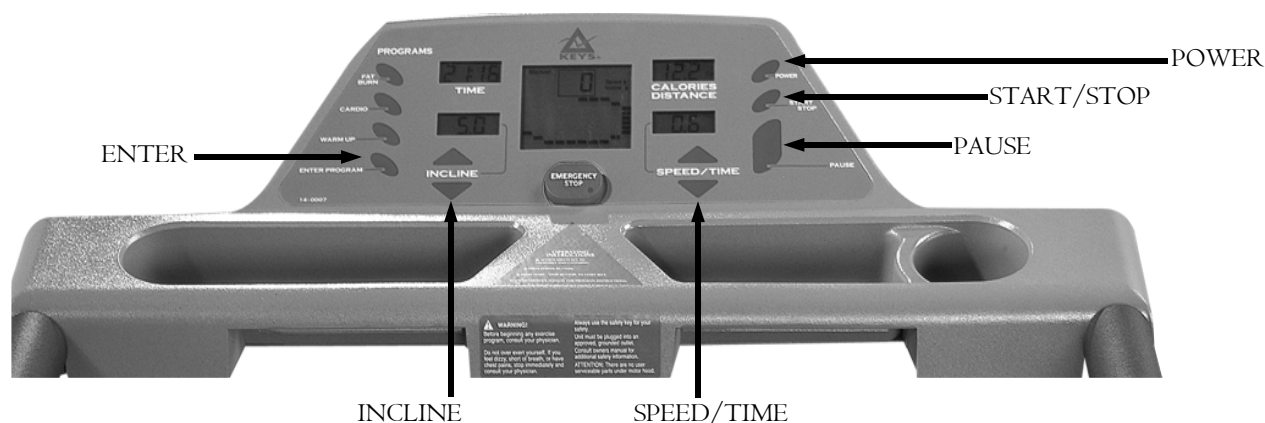

PROGRAM MODE

- ◆ Plug treadmill into a surge protector outlet . Attach RED Safety Key to treadmill console.
- ◆ Stand on the treadmill and straddle belt. Attach safety key clip to your clothes.
- ◆ Press POWER button. There will be an eight (8) second delay before data can be entered. The TIME window will flash.
- ◆ There are four (3) pre-set and six (6) custom pre-set programs on the EC1500-C. The treadmill includes FAT BURN, CARDIO, and WARM-UP programs. Select the program by pressing the appropriate button.
- ◆ Press START/STOP button. Belt will begin to move after 4 seconds. Step on belt slowly after the belt starts moving.
- ◆ **CUSTOMIZING PROGRAMS in P1 and P2 Mode:** Each pre-set program(Fat Burn, Cardio, Warm-up) can be customized in the P1 or P2 mode. After making the program selection, the center window will read “OP”. The ”OP” refers to “original program” and is preset. The program name you select will display to the left of the “OP”. Press the same program button once more and the center window will read P1. The “P1” mode is now accessed. You can now program the Time, Speed, and Incline in P1 mode, which will be saved for future workouts.
 - 1) The TIME window will blink. Use the SPEED/TIME + or – arrows to select your workout time. Press ENTER PROGRAM.
 - 2) The SPEED/TIME window will then blink. Use the same + or – arrows to select the speed for your workout. Press ENTER PROGRAM.
 - 3) The INCLINE window will then blink. Use the INCLINE + or – arrows to set your workout incline. Press ENTER PROGRAM.To start, press the START/STOP button. To access P2 mode, press the selected program button three times (once for OP, twice for P1, three times for P2). Follow the above steps 1-3 to customize P2 settings.
- ◆ **TO CHANGE A PREVIOUSLY PROGRAMMED P1, P2, or user program:** Once you have programmed the P1 or P2 modes, you will need to use the PAUSE button to change the program you previously entered. For instance to change to a new setting in P1-FAT BURN, press the FAT BURN button twice to access P1. Then press the PAUSE button to get the TIME window to flash. Follow the directions above to continue to change the program.

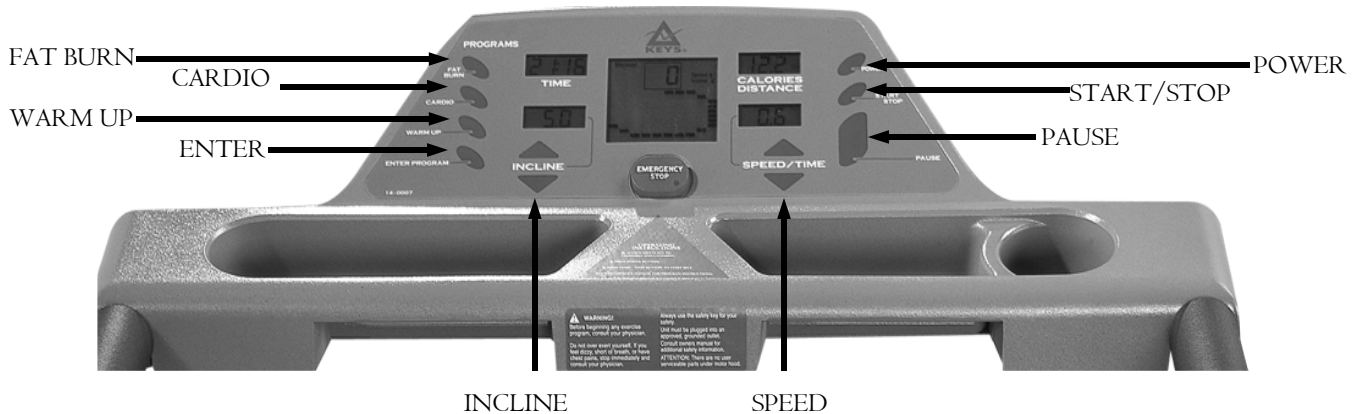

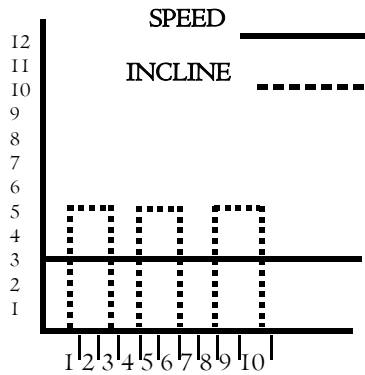

The **Fat Burn Program** is designed to vary the treadmill elevation, while maintaining a constant walking belt speed.

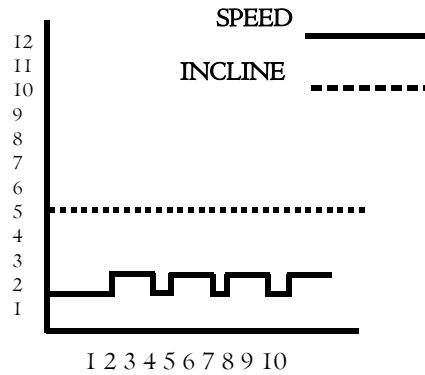

The **Cardio Program** is designed to vary the treadmill Speed, while maintaining a constant Elevation.

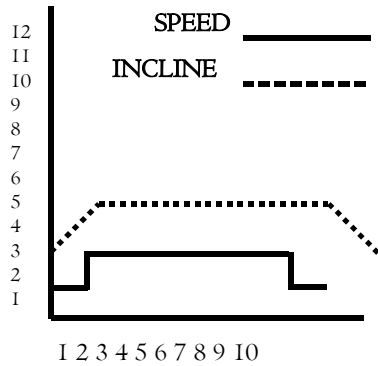

The **Warm Up Program** is designed to gradually increase the treadmill Speed and Elevation in the first segment (warm up) and gradually decrease the treadmill Speed and Elevation in the last segment (cool down). This is also known as a Plateau program.

WARNING! Do not overtighten rollers! This will cause premature roller bearing failure!

Belt adjustment and tension performs two functions: adjustment for tension and centering. Your new treadmill comes pre-adjusted from the factory for tension and centering. Please follow the procedures below if the belt shifts to the left or right while walking:

WALKING BELT IS SHIFTING TO THE LEFT (Diagram 1)

First, turn treadmill on to run at 1 mph. Using the hex key provided, turn the left rear roller adjustment bolt $\frac{1}{4}$ turn in the clockwise direction. Next, run the treadmill at 2.5 mph. You should see the belt start to correct itself by moving back towards the center. Repeat the above procedure until the walking belt is centered. It may be necessary to set walking belt tension once you have completed this procedure if the belt feels like it is slipping while walking. Refer below to the “Walking Belt Slipping” instructions.

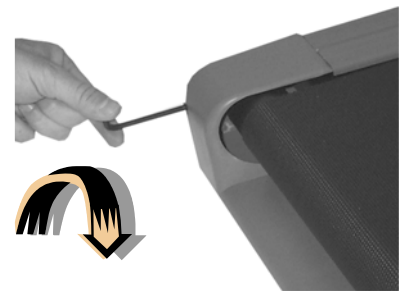

WALKING BELT IS SHIFTING TO THE RIGHT (Diagram 2)

First, turn the treadmill on to run at 1 mph. Using the hex key provided, turn the right rear roller adjustment bolt $\frac{1}{4}$ turn in the clockwise direction. Next, run the treadmill at 2.5 mph. You should see the belt start to correct itself moving back towards the center. Repeat the above procedure until the walking belt is centered. It may be necessary to set walking belt tension once you have completed this procedure if the belt feels like it is slipping while walking. Refer below to the “Walking Belt Slipping” instructions.



WALKING BELT IS SLIPPING DURING USE (Diagram 3)

First, unplug the power cord from the surge protector. Using the hex key provided, turn both left and right rear roller adjustment bolts the same distance, usually a $\frac{1}{4}$ turn in the clockwise direction. Plug the power cord back into the surge protector and run the treadmill at 2.5 mph. You should now walk on the belt to determine if the belt is still slipping. Repeat the above procedure until the walking belt is not slipping. The tension should be just tight enough not to slip.

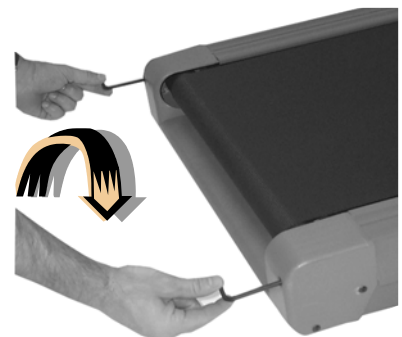

- ◆ Turning the hex key counter clockwise brings the rear rollers and belt towards you.
- ◆ Turning the hex key clockwise pushes the rear roller and belt away from you.

Change Miles per hour to Kilometers per hour



Your treadmill will operate in British Units (miles per hour) or International Units (kilometers per hour). All treadmills are calibrated at the factory for British Units (miles per hour). To change the display to read in kilometers, follow the steps described here:

- 1) Turn power OFF on the console. (Do not unplug treadmill) Attach the magnet safety key to the console.
- 2) Activate the calibration mode switch by inserting the eraser end of a pencil into the opening in the backside of the console (see diagram below).
- 3) Depressing the calibration mode switch ONCE; CLII should appear in the TIME window.
- 4) Pressing the SPEED +/- button will activate your choice.
- 5) To accept the setting, press the POWER button.



Treadmill will not start.

- 1) Is the RED Safety Key Attached to the Console?
- 2) Make sure the power cord is plugged into a surge protector, the surge protector is plugged into a properly grounded outlet, and the surge protector is turned on. (Refer to “Power Requirements” on page 8)
- 3) Check the circuit breaker located on the front of the treadmill. If the switch protrudes, it has tripped. Wait five minutes and then press the switch back in.
- 4) Check the house electrical breaker box and the circuit breaker for the room where the treadmill is located. If it has tripped, reset or have an electrician replace the breaker in home.
- 5) Have an electrician check for inadequate voltage at the outlet.

Treadmill loses power during use.

- 1) Check the circuit breaker located on the front of the treadmill. If the switch protrudes, it has tripped. Wait five minutes and then press the switch back in.
- 2) Check the house electrical breaker box and the circuit breaker for the room where the treadmill is located. If it has tripped, reset or have an electrician replace the breaker in home.
- 3) If treadmill still will not operate, please call Keys Technical Service at (888) 340-0482.

Treadmill walking belt slows during use.

- 1) Check to make sure the treadmill is securely plugged into an UL-listed surge protector, rated at 15 amps, with a 14-gauge cord of five feet or less and the surge protector is securely plugged into the outlet.
- 2) If treadmill still will not operate, please call Keys Technical Service at (888) 340-0482.

Treadmill walking belt slips or is not centered on rear roller.

- 1) Refer to “Belt Adjustment and Tension” section on page 13.
- 2) Need help? Call Keys Technical Service at (888) 340-0482.

Treadmill Error Messages.

Your treadmill is equipped with a software package that enables error messages to be displayed when there is a problem. **To avoid possible damage to the treadmill and the possibility of injury, do not operate the treadmill until the problem is corrected. Call Keys Technical Service at (888) 340-0482.**

1. 05-0001-Extrusion side board deluxe/left
2. 05-0001-Extrusion side board deluxe/right
3. 04-0008-Belt walk spliced 18 x 105WW
4. 24-0006-Front roller assembly
5. 09-0013-Rear roller assembly
6. 03-0004-Walkboard waxed
7. 06-0008-End cap
8. 12-0022-Actuator 400lb Maytech
9. 06-0026-Motor base pan
10. 06-0079-Small motor fan
11. 12-0033-Motor MCM 2.5HP
12. 04-0004-Poly V belt 190J8
13. 06-0025-Motor cover w/wings
14. 10-0003-Foam grips
15. 07-0026-Electronics 5 window brickyard
16. 24-0104-Console assembly-ECI500C
17. 08-0051-Motor controller

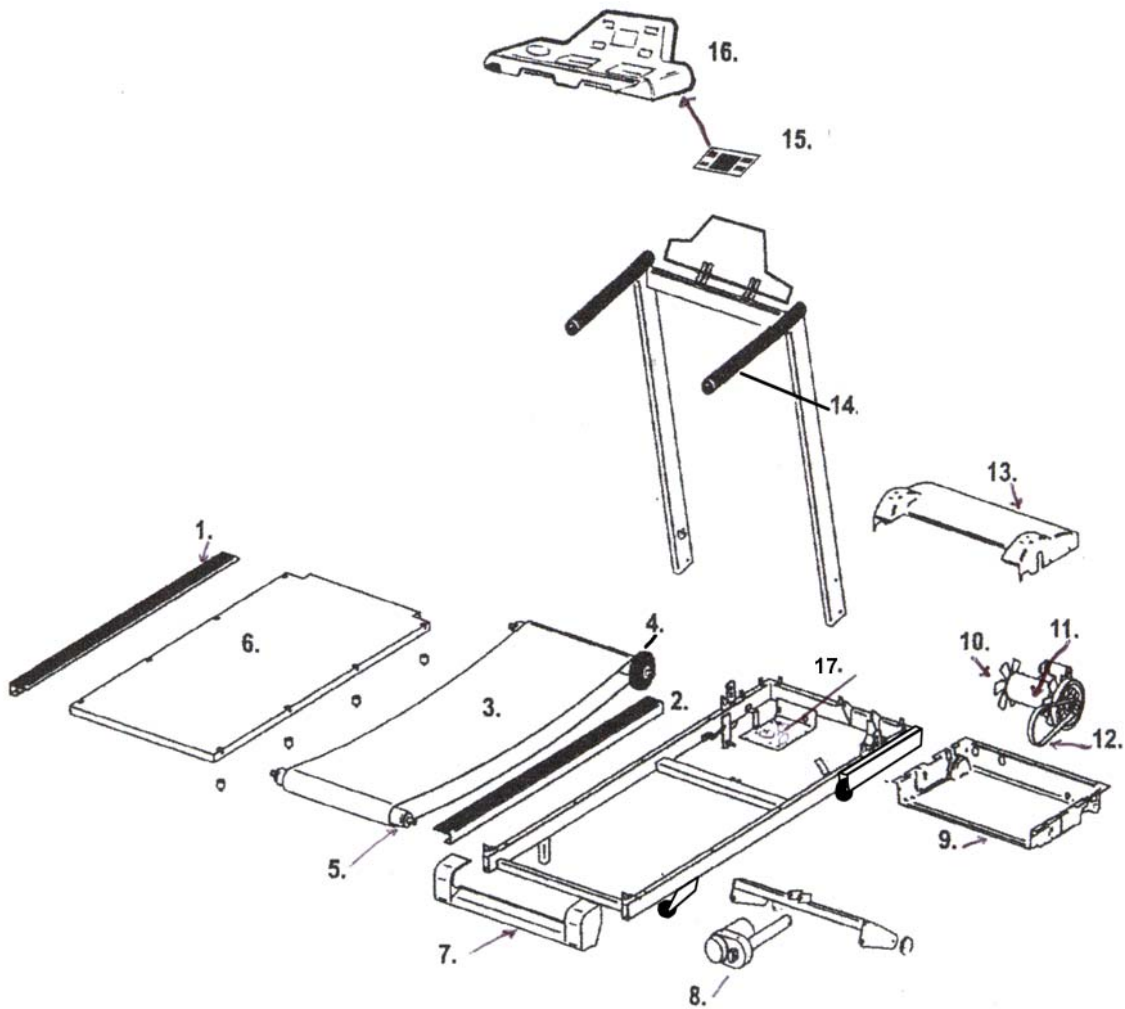

Encore I500-C Parts List



Parts List - EC1500C

PART #	DESCRIPTION	QTY	PART #	DESCRIPTION	QTY	PART #	DESCRIPTION	QTY
09-0013	ROLLER-REAR 20MM SHAFT	1	15-0103	MANUAL-EC1500	1	02-0108	SCREW-PPH 10 X 5/8"	1
12-0033	MOTOR MCM 2.5HP	1	14-0205	DECAL-DISCONNECT-MOTOR COVER	1	02-0113	SCREW-HWH SLOTTED 8-18 X 3/4" AB ZP	1
12-0022	ACTUATOR 400LB MAYTECH	1	19-0097	BRKT-ENCODER-MCMILLIAN	1	02-0123	WASHER-FENDER 1/4 X 1"	2
13-0003	HARNES-ENCODER	1	02-0041	SCREW-PPH 8-18x5/8" S/D-FOOTLATCH	1	16-0002	BOX BOTTOM	1
13-0011	POWER CORD-90"	1	02-0050	NUT-NYLOCK HEX 1/4-20	1	16-0001	BOX TOP	1
02-0040	RETAINER-GUIDE TUBE	1	02-0051	SCREW-SH CAP 10-24x1 1/4"	2	16-0003	PAD-FRONT WHEEL	2
03-0004	WALKBOARD WAXED	1	02-0053	SCREW-SHCS 1/4-20x3/4"	2	16-0004	PAD-REAR	1
04-0004	BELT-POLY V 190J8	1	02-0054	SCREW-HWH MACH 8-32x3/8"	1	16-0027	PAD-UPRIGHT	1
04-0008	BELT WALK SPLICED 18x105WW	1	02-0068	WASHER-FLAT SAE 5/16	2	18-0003	LINKAGE-BASE EXTENSION-RIGHT	1
05-0011	EXTRUSION-EN CAP JOINT	1	02-0092	SCREW-PHTR#8x3/4" AB BLACK	7	18-0004	LINKAGE-BASE EXTENSION-LEFT	1
06-0130	PULLEY 8 GROOVE-190JA	1	06-0079	FAN-MCM MOTOR-5" W/1/2"SHAFT	1	18-0006	SPRING-MOTOR TENSION-PRESET	1
06-0008	ENCAP	1	06-0088	SLEEVE-MOTOR TENSION 1/4"	1	19-0013	LATCH-FOOT LOCKING MECHANISM	1
06-0014	BUSHING-STRAIN RELIEF #1237	1	08-0004	CIRCUIT BREAKER 15AMP	1	19-0134	BRKT BASE ELEVATION	1
06-0019	CENTER BASE PAN	1	08-0047	ENCODER-OPTICAL-ALEPH	1	19-0015	BRKT-MOTOR COVER	7
06-0020	END BASE PAN	1	08-0051	CONTROLLER-REVISED 08-0014	1	20-0003	PROC-ACTUATOR EXT. TB-17-0011	1
06-0021	CLAMP-WIRE 3367 7/16	1	08-0077	CORE-FERRITE	1	23-0003	REAR ELEVATION ASSEMBLY-WELDED	1
06-0022	GUIDE-RESET TUBE	1	24-0006	FRONT ROLLER ASSEMBLY	1	23-0090	UPRIGHT ASSEMBLY	1
06-0025	MOTOR COVER CSA	1	13-0007	WIRE-BREAKER 6"	1	20-0008	PROC-BASE EXTENSION TB 17-0010	2
06-0026	FRONT BOTTOM PAN-CSA	1	13-0016	HARNES-CONTROL PANEL	1	23-0001	DECK FRAME ASSEMBLY	1
24-0104	COMPLETE CONSOLE ASSEMBLY	1	02-0002A	SPRING-DECK LIFT	4	10-0012	BUMBER LATCH	1
10-0003	FOAM GRIP 1.5x14.75	2	02-0004	SCREW-8x5/8 PHIL PH AB BLACK	40	10-0017	TAPE-FOAM-1" X 75FT	0.5
10-0004	RUBBER FOOT	2	02-0005	SCREW-8x5/8 PHIL HILO BLACK TPB	8	11-0002	BUSHING-REAR ELEVATION	2
19-0019	GUIDE BELT GALVANIZED	2	02-0006	BOLT-HEX 5/16-18x5 1/2 GRADE 5-ZP	1	11-0003	BUSHING-UPRIGH POVOT	2
19-0032	BRKT-SPRING ANCHOR	2	02-0007	NUT-5/16-18 NYLOCK ZP	3	14-0003	DECAL-MOTOR COVER SES-ALL-GRAY	1
02-0036	SCREW-PPH 8x 5/8 GREEN HEAD	2	02-0008	BOLT-HEX 5/16-18x 3/4"GRADE 2-ZP	3	14-0016	DECAL-MOTOR COVER-EC1500-TEAL	1
05-0001	EXTRUSION-SIDE BOARD-DELUXE	2	02-0024	CARRIAGE BOLT 5/16 X 1GRADE 5 ZP	2	14-0023	DECAL-NO LIFT - ALL FOLDS	1
05-0014	BOTTOM PAN JOINT 21 1/2	2	02-0025	WHEEL AXLE 2"	2	14-0024	DECAL-SAFETY LATCH-ALL FOLDS	1
06-0004	PLUG-BASE 1.5x3"-16GA	2	02-0027	NUT-T HF 14209H-DB	8	14-0025	DECAL-WARNING FOLDING-ALL FOLDS	1
06-0005	PLUG-DOME 1.5-16G	2	02-0009	NUT-HEX 5/16 WIZ-FL-LK-ZP	3	02-0099	WASHER	1
06-0012	WHEEL 3"	2	02-0013	WASHER-LOCK 1/4"	8	02-0028	SWITCH-MAGNETIC LIKK-YIHAN	1
06-0125	SPACER FOR UPRIGHT	2	02-0031	HEX BOLT, 3/8-16 X 1 3/4 GRADE 5 ZP	2	02-0038	WRENCH-ALLEN 3/16 SHAFT ARM	1
06-0009	GLIDE-BASE EXTENSION	4	02-0033	WASHER-#10 EXTERNAL STAT	1	06-0024	CLIP-ALLEN WRENCH	1
06-0133	WHEEL-ROLLER 2"	4	02-0014	HEX BOLT, 1/4-20x2 1/2"GRADE 5 ZP	11	06-0084	BAG-PLASTIC 12 X 12 3 MIL-INST PACKET	1
10-0002	ISOLATOR BOARD	8	02-0015	SPRING WASHER	4	14-0321	10 YEAR WARRANY DECAL	1
06-0016	WIRE TIES	12	02-0016	HEX BOLT 3/8-16x2 1/2" GRADE 5	1	02-0019	CARRIAGE BOLT 10-24x1 1/2"	4
02-0022	NYLOCK NUT HEX 10-24	6	02-0017	NYLOCK HEX NUT 3/8-16	3	02-0020	SCREW-SHCS 1/4-20x2 1/2"	2
14-0028	DECAL-CIRCUIT BREAKER-ALL	1	02-0018	PUSH NUT 3/8 HAT BLACK 375012	4	02-0021	WASHER-9/32 5/8 1/8 THICK ZP	2
14-0069	DECAL-END CAP LOGO-BLK/TEAL/RED	2	14-0089	DECAL-STARBURST-WASDECK-YELLOW	2	14-0026	DECAL-WARNING CONSOLE-ALL-GRAY	1
14-0027	DECAL-EMERGENCY STOP-RED	1	22-0001	ACTUATOR CONNECTION ASSEMBLY	1	14-0204	DECAL-OPERATION INSTALL	1
	INST PACKET-EC1500C	1						

KeysEncore 1500-C Treadmill KEYS FITNESS PRODUCTS, LP – LIMITED WARRANTY

PLEASE CONSULT YOUR PHYSICIAN BEFORE USING THIS PRODUCT.

This Limited Warranty applies in the United States, Canada, and Mexico to products manufactured or distributed by Keys Fitness Products, LP ("Keys") under the KEYS brand name. The warranty period on the ENCORE 1500-C to the original purchaser is (lifetime) on the frame, (10) years on the motor, (2) years parts, and (2) year labor.

Keys warrants that the Product you have purchased for non-commercial, personal, family, or household use from Keys or from an authorized Keys reseller is free from defects in materials or workmanship under normal use during the warranty period. Your sales receipt, showing the date of purchase of the Product, is your proof of the date of purchase. This warranty only extends to you, the original purchaser. It is not transferable to anyone who subsequently purchases the Product from you. It excludes expendable parts. This Limited Warranty becomes VALID ONLY if the treadmill is assembled/installed by a Keys Fitness authorized dealer/technician unless otherwise authorized by Keys Fitness in writing (if anyone other than a Keys Fitness authorized dealer/technician assembles a Keys Fitness treadmill the warranty will be void unless accompanied by written authorization by Keys Fitness).

During the warranty period Keys will at no additional charge, repair or replace (at Keys' option) the product if it becomes defective, malfunctions, or otherwise fails to conform with this Limited Warranty under normal non-commercial, personal family or household use. In repairing the Product, Keys may replace defective parts, or at the option of Keys, serviceable used parts that are equivalent to new parts in performance. All exchanged parts and Products replaced under this warranty will become the property of Keys. Keys reserves the right to change manufacturers of any part to cover any existing warranty.

To obtain warranty service, you must contact a Keys authorized service technician or Keys Fitness at our phone numbers located in this manual. Any parts determined to be defective must be returned to Keys to obtain warranty service. You must prepay any shipping charges, export taxes, custom duties and taxes, or any other charges associated with transportation of the parts or Product. In addition, you are responsible for insuring any parts or Product shipped or returned. You assume the risk of loss during shipment. You must present Keys with proof-of-purchase documents (including the date of purchase). Any evidence of alteration, erasing or forgery of proof-of-purchase documents will be cause to void this Limited Warranty.

This warranty does not extend to any product not purchased from Keys or from an authorized Keys reseller. This Limited Warranty does not extend to any Product that has been damaged or rendered defective; (a) as a result of accident, misuse, or abuse; (b) by the use of parts not manufactured or sold by Keys; (c) by modification of the Product or normal wear and tear; (d) operation on incorrect power supplies; or (e) as a result of service by anyone other than Keys, or an authorized Keys warranty service provider. Product on which the serial number has been defaced or removed is not eligible for warranty service. Should any Product be submitted for warranty service be found ineligible therefore, an estimate of repair cost will be furnished and the repair will be made if requested by you upon Keys' receipt of payment or acceptable arrangements for payment.

EXCEPT AS EXPRESSLY SET FORTH IN THIS WARRANTY, KEYS MAKES NO OTHER WARRANTIES, EXPRESSED OR IMPLIED, INCLUDING ANY IMPLIED WARRANTIES OF MERCHANTABILITY AND FITNESS FOR A PARTICULAR PURPOSE. KEYS EXPRESSLY DISCLAIMS ALL WARRANTIES NOT STATED IN THIS LIMITED WARRANTY. ANY IMPLIED WARRANTIES THAT MAY BE IMPOSED BY LAW ARE LIMITED TO THE TERMS OF THIS LIMITED WARRANTY. NEITHER KEYS NOR ANY OF ITS AFFILIATES SHALL BE RESPONSIBLE FOR INCIDENTAL OR CONSEQUENTIAL DAMAGES. SOME STATES DO NOT ALLOW LIMITATIONS ON HOW LONG AN IMPLIED WARRANTY LASTS OR THE EXCLUSION OR LIMITATION OF INCIDENTAL OR CONSEQUENTIAL DAMAGES, SO THE ABOVE LIMITATIONS OR EXCLUSION MAY NOT APPLY TO YOU. This Limited Warranty gives you specific legal rights and you may also have other rights that may vary from state to state. This is the only express warranty applicable to Keys-branded products. Keys neither assumes nor authorizes anyone to assume for it any other express warranty.

PLEASE SEND IN THE ATTACHED WARRANTY CARD WITHIN TEN (10) DAYS OF PURCHASE TO REGISTER YOUR TREADMILL WITH KEYS FITNESS PRODUCTS, LP. MADE IN THE USA. **Thank you for your business!** PLEASE MAIL WARRANTY CARD TO: KEYS FITNESS PRODUCTS, PO BOX 551239, DALLAS, TX 75355.

KEYS FITNESS TREADMILL WARRANTY REGISTRATION				TELEPHONE																											
FIRST	M.I.	LAST	<input type="text"/> <input type="text"/> <input type="text"/> - <input type="text"/> <input type="text"/> <input type="text"/> <input type="text"/> <input type="text"/> <input type="text"/> <input type="text"/> <input type="text"/>																												
<input type="text"/> <input type="text"/> <input type="text"/> <input type="text"/> <input type="text"/> <input type="text"/> <input type="text"/> <input type="text"/> <input type="text"/> <input type="text"/> <input type="text"/> <input type="text"/> <input type="text"/> <input type="text"/> <input type="text"/> <input type="text"/> <input type="text"/> <input type="text"/> <input type="text"/> <input type="text"/>																															
ADDRESS								APT. NO.																							
<input type="text"/> <input type="text"/> <input type="text"/> <input type="text"/> <input type="text"/> <input type="text"/> <input type="text"/> <input type="text"/> <input type="text"/> <input type="text"/> <input type="text"/> <input type="text"/> <input type="text"/> <input type="text"/> <input type="text"/> <input type="text"/> <input type="text"/> <input type="text"/> <input type="text"/> <input type="text"/>								<input type="text"/> <input type="text"/> <input type="text"/> <input type="text"/>																							
CITY				STATE		ZIP																									
<input type="text"/> <input type="text"/> <input type="text"/> <input type="text"/> <input type="text"/> <input type="text"/> <input type="text"/> <input type="text"/> <input type="text"/> <input type="text"/> <input type="text"/> <input type="text"/> <input type="text"/> <input type="text"/> <input type="text"/> <input type="text"/> <input type="text"/> <input type="text"/> <input type="text"/> <input type="text"/>				<input type="text"/> <input type="text"/> <input type="text"/>		<input type="text"/> <input type="text"/> <input type="text"/> <input type="text"/> <input type="text"/> <input type="text"/>																									
DATE OF PURCHASE			MODEL NO.				SERIAL NO.																								
<input type="text"/> <input type="text"/> - <input type="text"/> <input type="text"/> - <input type="text"/> <input type="text"/>			<input type="text"/> <input type="text"/> <input type="text"/> <input type="text"/> <input type="text"/> <input type="text"/> <input type="text"/> <input type="text"/> <input type="text"/> <input type="text"/> <input type="text"/> <input type="text"/> <input type="text"/> <input type="text"/> <input type="text"/> <input type="text"/> <input type="text"/> <input type="text"/> <input type="text"/> <input type="text"/>				<input type="text"/> <input type="text"/> <input type="text"/> <input type="text"/> <input type="text"/> <input type="text"/> <input type="text"/> <input type="text"/> <input type="text"/> <input type="text"/> <input type="text"/> <input type="text"/> <input type="text"/> <input type="text"/> <input type="text"/> <input type="text"/> <input type="text"/> <input type="text"/> <input type="text"/> <input type="text"/>																								
Name of store or company where purchased: <input style="width:100%; height: 20px;" type="text"/>			Where did you learn about treadmills? TV___ Radio___ Friend___ In Store Display___ Salesperson___ Print ad/flyer___ Internet___				How important are each feature: <table border="1" style="width:100%; border-collapse: collapse;"> <thead> <tr> <th></th> <th style="text-align: center;">Least</th> <th style="text-align: center;">Most</th> </tr> </thead> <tbody> <tr> <td>Unique Features</td> <td style="text-align: center;"><input type="text"/></td> <td style="text-align: center;"><input type="text"/></td> </tr> <tr> <td>Horsepower</td> <td style="text-align: center;"><input type="text"/></td> <td style="text-align: center;"><input type="text"/></td> </tr> <tr> <td>Warranty</td> <td style="text-align: center;"><input type="text"/></td> <td style="text-align: center;"><input type="text"/></td> </tr> <tr> <td>Price</td> <td style="text-align: center;"><input type="text"/></td> <td style="text-align: center;"><input type="text"/></td> </tr> <tr> <td>Look/Design</td> <td style="text-align: center;"><input type="text"/></td> <td style="text-align: center;"><input type="text"/></td> </tr> <tr> <td>Folding Feature</td> <td style="text-align: center;"><input type="text"/></td> <td style="text-align: center;"><input type="text"/></td> </tr> </tbody> </table>				Least	Most	Unique Features	<input type="text"/>	<input type="text"/>	Horsepower	<input type="text"/>	<input type="text"/>	Warranty	<input type="text"/>	<input type="text"/>	Price	<input type="text"/>	<input type="text"/>	Look/Design	<input type="text"/>	<input type="text"/>	Folding Feature	<input type="text"/>	<input type="text"/>	Other Comments: <input style="width:100%; height: 20px;" type="text"/> <input style="width:100%; height: 20px;" type="text"/> <input style="width:100%; height: 20px;" type="text"/>
	Least	Most																													
Unique Features	<input type="text"/>	<input type="text"/>																													
Horsepower	<input type="text"/>	<input type="text"/>																													
Warranty	<input type="text"/>	<input type="text"/>																													
Price	<input type="text"/>	<input type="text"/>																													
Look/Design	<input type="text"/>	<input type="text"/>																													
Folding Feature	<input type="text"/>	<input type="text"/>																													
How do you plan to use the treadmill? Walk___ Run___ Both___			Why did you purchase a treadmill? Dr.'s Orders___ Loose Weight___ In-home convenience___ Improve Cardiovascular Fitness___ Safety from outdoors___ Other___				KEYS FITNESS respects the rights of your privacy. Our company will not sell or distribute to others the information above. This information is used to track our product quality and to contact you in the event of a product safety concern. It may be used to offer you future Keys products only through the mail. Please check here if wish not to receive any additional information on Keys products.			<input type="checkbox"/>																					
Who will use the treadmill? Male___ Female___ Both___ How many family members? ___			AGE: 15-24___ 25-34___ 35-44___ 45-54___ 55-64___ 65 +___																												

Free Manuals Download Website

<http://myh66.com>

<http://usermanuals.us>

<http://www.somanuals.com>

<http://www.4manuals.cc>

<http://www.manual-lib.com>

<http://www.404manual.com>

<http://www.luxmanual.com>

<http://aubethermostatmanual.com>

Golf course search by state

<http://golfingnear.com>

Email search by domain

<http://emailbydomain.com>

Auto manuals search

<http://auto.somanuals.com>

TV manuals search

<http://tv.somanuals.com>