



KeysFitness®

2.5T

Owner's Manual

Keys Fitness KF-2.5T Treadmill

Customer Service
(888) 340-0482

Keys Fitness Products
4009 Distribution Drive
Suite 250
Garland, TX 75041

www.keysfitness.com

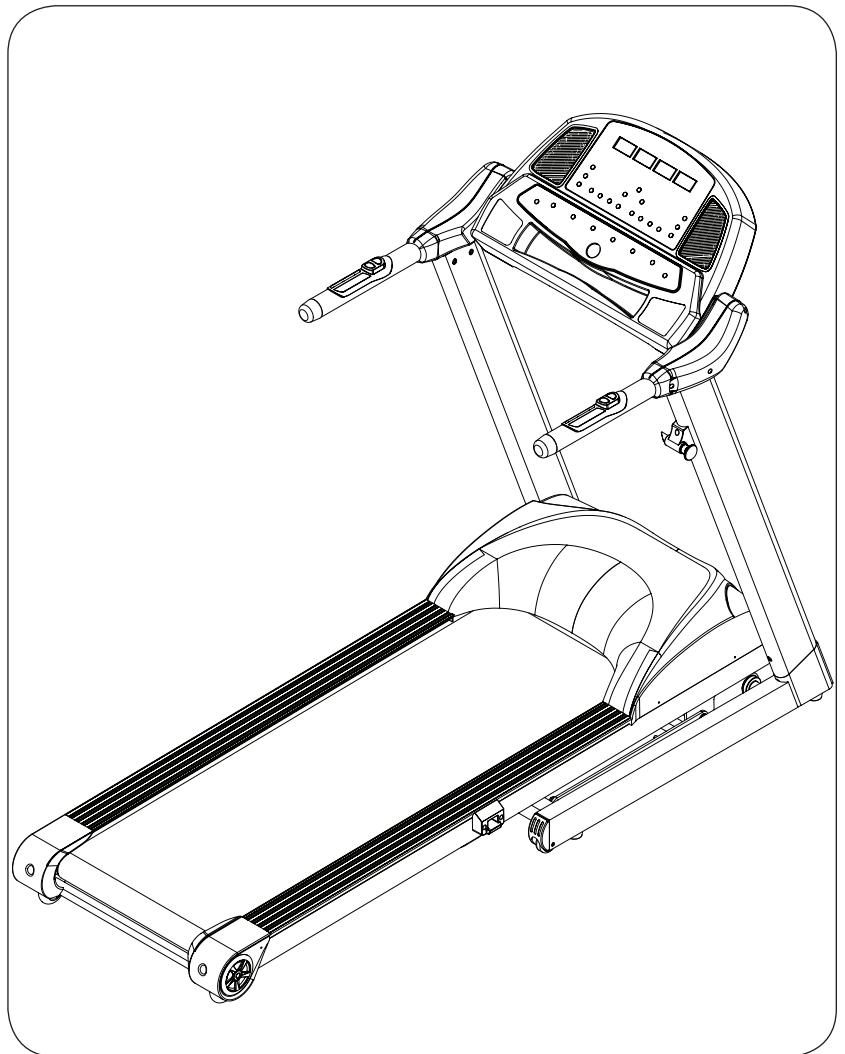

CAUTION! Read all precautions and instructions in this manual before using this equipment.

Model Name : KF-2.5T

Serial Number :

Write down for future reference

Serial Number Decal Location

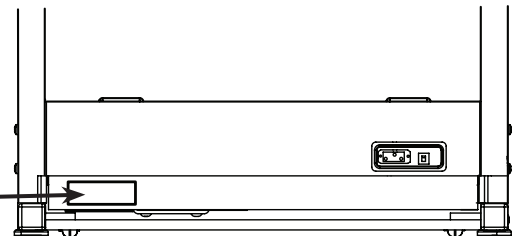

415-00178
10/07 Rev B

Table of Contents

Important Safety Information	3
Before You Start	4
Assembly	5
Parts Identifier	5
Assembly Steps	6
Moving Instructions	10
Power Requirements	11
Console Instructions	12
Overview	12
MP3 Input	12
Program Operation	14
Program Profiles	17
Monitoring Your Heart Rate	19
Workout Information	21
Frequency: How Often Should You Exercise	21
Intensity: How Hard Should You Exercise	21
Weight Management	21
Exercise Practice Procedures	22
Workout: Brisk and Rhythmic Exercise	22
Cool Down: Slow and Relaxed Exercise	22
Exercise Guidelines	23
Calibration Sequence	26
Change to MPH or KPH	26
Belt Adjustment	27
Maintenance Instructions	28
Error Messages	29
Troubleshooting Guide	30
Parts List	31
Exploded View	32
Warranty	33

Important Safety Information



WARNING! Before using this treadmill or starting any exercise program, consult your physician. This is especially important for persons over the age of 35 and/or persons with pre-existing health problems. The manufacturer or distributor assumes no responsibility for personal injury or property damage sustained by or through the use of this product.

WARNING! To reduce the risk of electrical shock, burns, fire, or other possible injuries to the user, it is important to review this manual and the following precautions **before** operation.

SAVE THESE INSTRUCTIONS

SAFETY PRECAUTIONS AND TIPS

1. Always secure Safety Key firmly to waistband.
2. It is the owner's responsibility to ensure that all users of this treadmill have read the Owner's Manual and are familiar with warnings and safety precautions.
3. This treadmill has a user maximum capacity of **300** pounds.
4. The treadmill should only be used on a level surface and is intended for indoor use only. The treadmill should not be placed in a garage, patio, or near water and should never be used while you are wet. Keys Fitness recommends a treadmill mat be placed under the treadmill to protect floor or carpet and for easier cleaning.
5. Follow safety information in regard to plugging in your treadmill. Keep the power cord away from the incline wheels and do not run the power cord underneath your treadmill. Do not operate the treadmill with a damaged or frayed power cord.
6. Wear comfortable, good-quality walking or running shoes and appropriate clothing. Do not use the treadmill with bare feet, sandals, socks or stockings.
7. Always straddle the belt and allow it to start moving before stepping onto the belt.
8. Hold on to handlebar when adjusting speed or other controls.
9. Always examine your treadmill before using to ensure all parts are in working order.
10. Allow the belt to fully stop before dismounting.
11. Pets should never be allowed near or on the treadmill.
12. Close supervision is necessary when this appliance is used by or near children, invalids or disabled persons.
13. Never operate the treadmill where oxygen is being administered, or where aerosol products are being used.
14. Never insert any object or body parts into any opening.
15. For safety and to prevent damage to your treadmill, no more than one person should use the treadmill at a time.
16. Always unplug the treadmill before cleaning and/or servicing. Service to your treadmill should only be performed by an authorized service representative, unless authorized and/or instructed by the manufacturer
17. Failure to follow these instructions will void the treadmill warranty.
18. Never leave the treadmill unattended when plugged in. Unplug from outlet when not in use and before service or maintenance.
19. Always unplug this appliance immediately after using and before cleaning. To disconnect, turn all controls to the off position, then remove plug from outlet.

Before You Start



Thank you for purchasing the **Keys Fitness KF-2.5T Treadmill!** This quality product you have chosen was designed to meet your needs for cardiovascular exercise. Before you start, please read the Owner's Manual and become familiar with the operation of your new treadmill.

Remember to take the time to perform the stretching exercises provided to avoid injury.

Do not stand on the walking belt while pressing the Power button or Start/Stop button. Always adjust the speed of the treadmill in small increments as this treadmill is capable of high speeds.

If you are taking medication, consult your physician to see if the medication will affect your exercise heart rate.

If you have heart problems, you are not active, and/or are over the age of 35 years, do not use the pre-set treadmill programs or start an exercise program without first contacting and receiving approval from your physician.

To avoid the risk of electrical shock, always keep the console dry. Do not spill liquids on the console. Keys Fitness recommends a sealed water bottle for beverages consumed while using the treadmill.

Please review the following drawing below to familiarize yourself with the listed parts. This manual covers several treadmills, so the one pictured below may not be identical to your particular model.

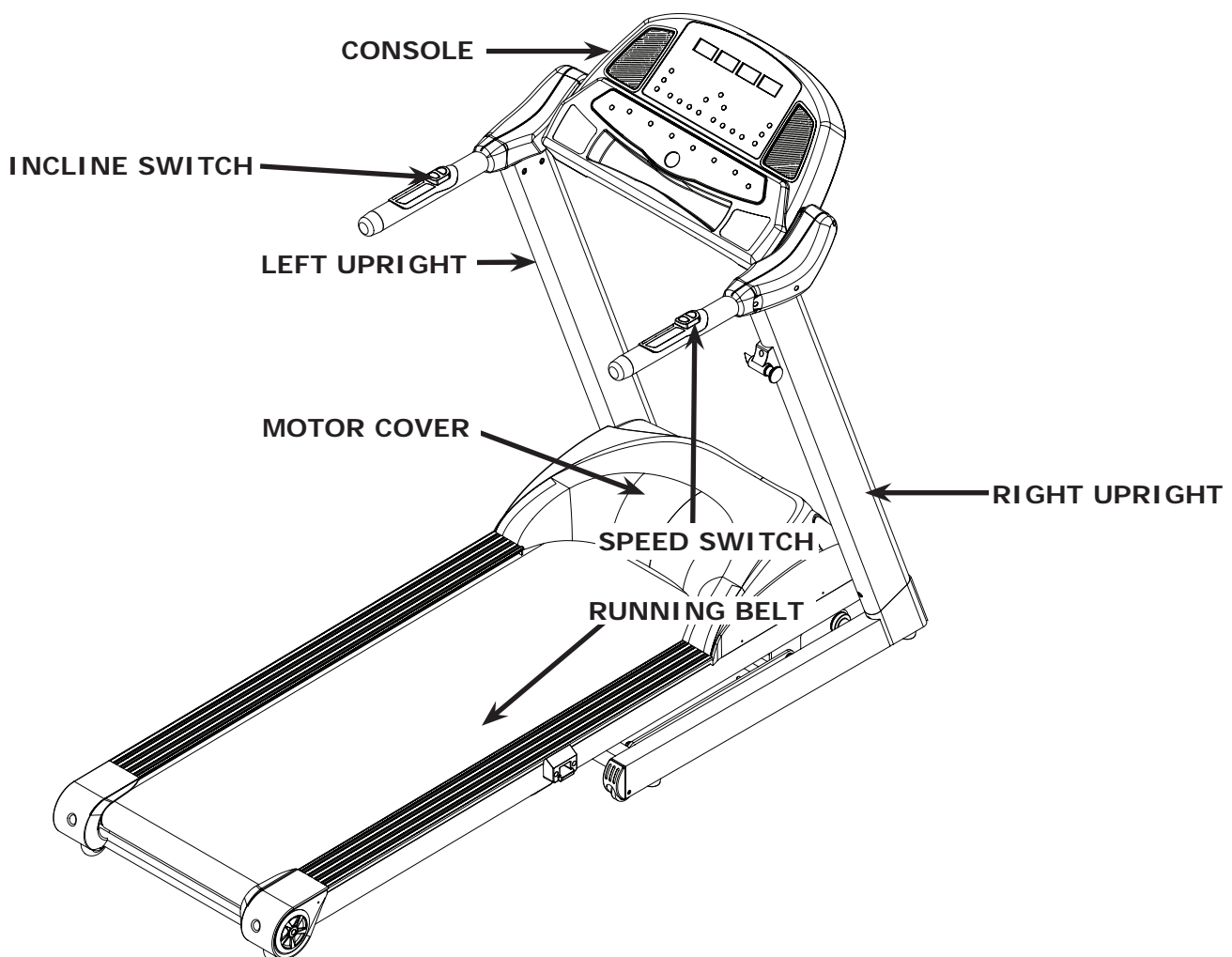

Assembly: Parts Identifier

The **Keys Fitness KF-2.5T Treadmill** will require assembly before operating. Place unopened box on a clean, level surface. After opening the box, remove any packing material from the treadmill.

Do not throw away any packing materials until the unit is working properly.

Do not remove unit from box until it has been fully assembled.











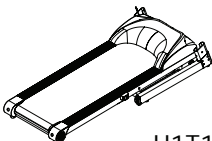
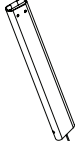
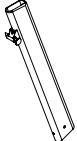
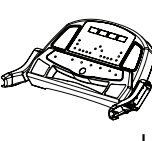

Make sure the electrical cord will easily reach an electrical outlet.

If at anytime you need assistance with assembly, call **888-340-0482**.

Locate the hardware pack and identify the following parts required for assembly.

Tools:

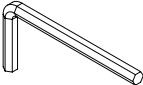
1. Allen Wrench- 3/16"
2. Allen Wrench- 7/32"
3. Phillips Screwdriver

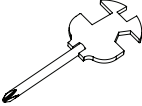
 U1T1	 UAT4	 UAT5	 UAD1	 UAT6	 UAT7
 UAS29	 UAS30	 UAJ24	 UAJ5	 UAJ7	 UAJ28
 UAJ27	 UAW8	 UAW9	 UAW10		

Ref #	Description	Qty	Ref #	Description	Qty
U1T1	MAIN FRAME	1	UAJ24	SCREW ST4.2*12	6
UAT4	LEFT UPRIGHT	1	UAJ5	BOLT M10*25	12
UAT5	RIGHT UPRIGHT	1	UAJ7	BOLT M8x52	4
UAD1	CONSOLE	1	UAJ28	SAWTOOTH WASHER #8	4
UAS29	LEFT PROTECTION COVER	1	UAJ27	SAWTOOTH WASHER #10	12
UAS30	RIGHT PROTECTION COVER	1	UAW8	#6 ALLEN WRENCH	1
UAT6	LEFT HANDLEBAR	1	UAW9	#5 ALLEN WRENCH	1
UAT7	RIGHT HANDLEBAR	1	UAW10	WRENCH W/SCREW DRIVER	1

Assembly

Assembly requires the included Allen wrench and Phillips screwdriver. Leave the unit on the original packing material to assemble all parts.

Do not plug in the power cord until all assembly steps are completed.

1. Remove top cover of box, and break the sides of the box to create a level assembly surface. After opening the box, remove any packing material from the treadmill. Carefully cut the strap surrounding the treadmill, only while the treadmill is laying flat.

Do not remove unit from box until it has been fully assembled.

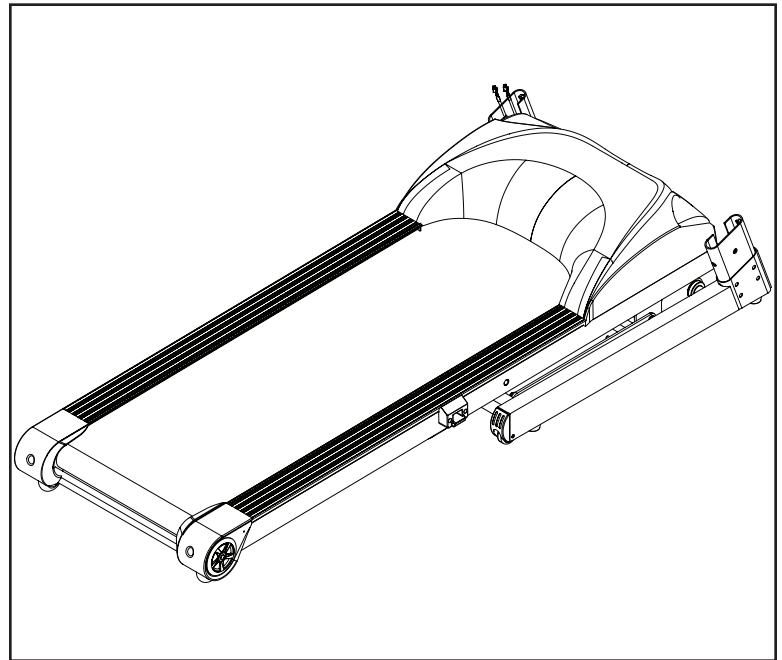

Figure 1: Unpacking Treadmill

2. Locate the left upright. Connect the console harness together. One side of harness is located near the motor cover on the bottom left side. The other end is located inside the left upright.

Connect the amplifier harness together. One side of harness is located near the motor cover on the bottom left side. The other end is located inside the left upright. **Note:** Make sure that the console harness and amplifier harness are inside of the upright and not being pinched.

Slide the left upright onto the base frame.

Secure the left upright to the base frame by using four bolts M10x25 and four washers #10.

Note: Do not tighten hardware until step 5 has been completed.

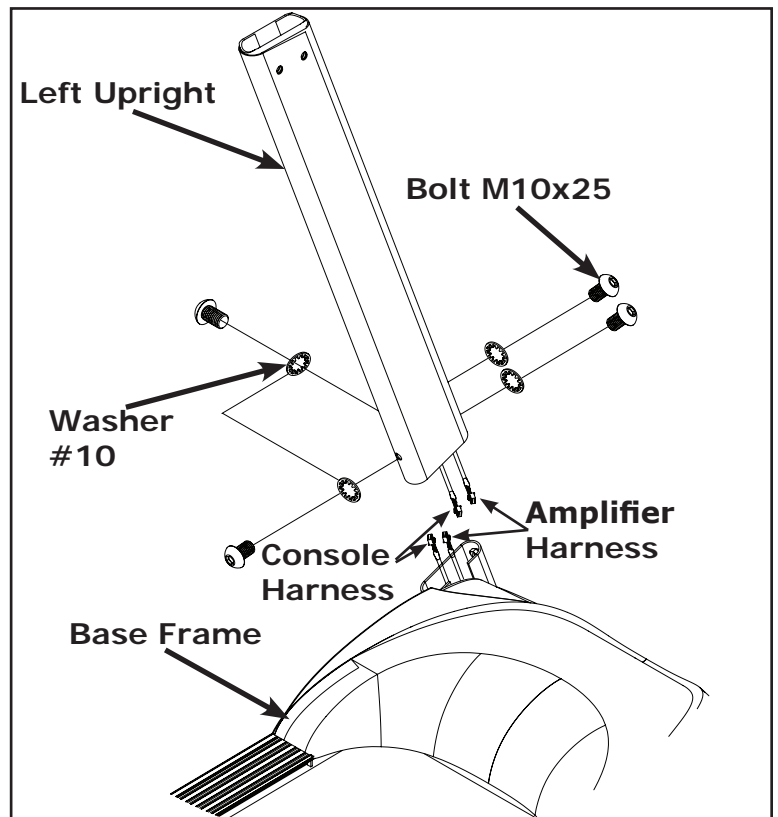

Figure 2: Left Upright Installation

3. Slide the right upright onto the base frame. Secure the right upright to the base frame by using four bolts M10x25 and four washers #10.

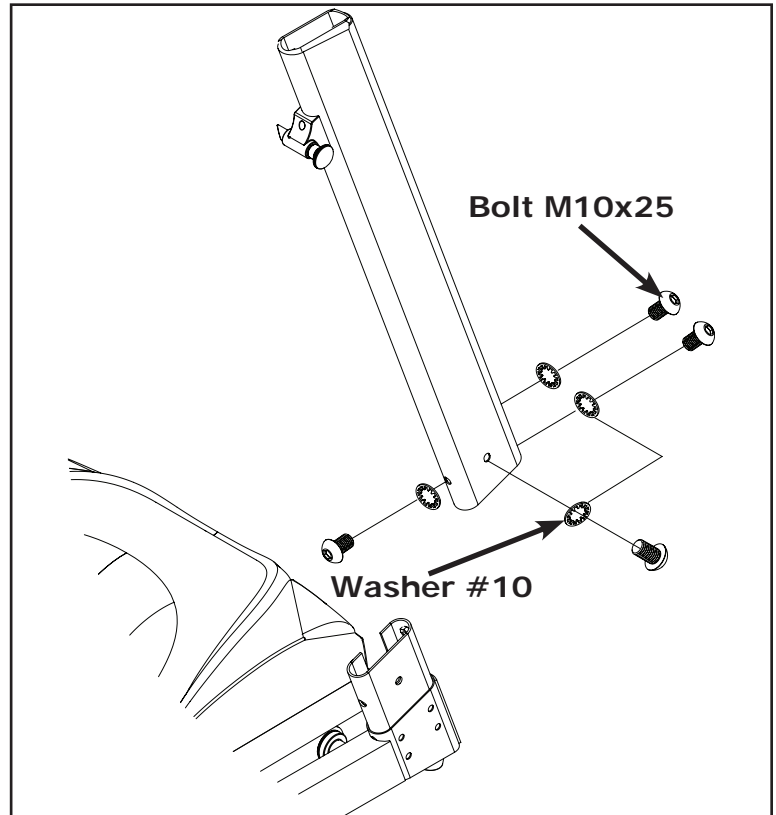

Figure 3: Right Upright Installation

4. Feed the wires coming out of left side of the console through the hole located on the tube of the left handlebar. Connect the amplifier wire coming from the handlebar to the amplifier wire coming from the console. Connect the EKG harness and the toggle harness coming from the handlebar to the EKG harness and the toggle harness coming from the console. Secure the left handlebar to console using two bolts M8x52 and two washers #8.

Feed the wires coming out of the right side of the console through the hole located on the tube of the right handlebar. Connect the EKG harness and the toggle harness coming from the handlebar to the EKG harness and the toggle harness coming from the console. Secure the right handlebar to console using two bolts M8x52 and two washers #8.

NOTE: Make sure not to pinch or screw through any wires when securing the left handlebar.

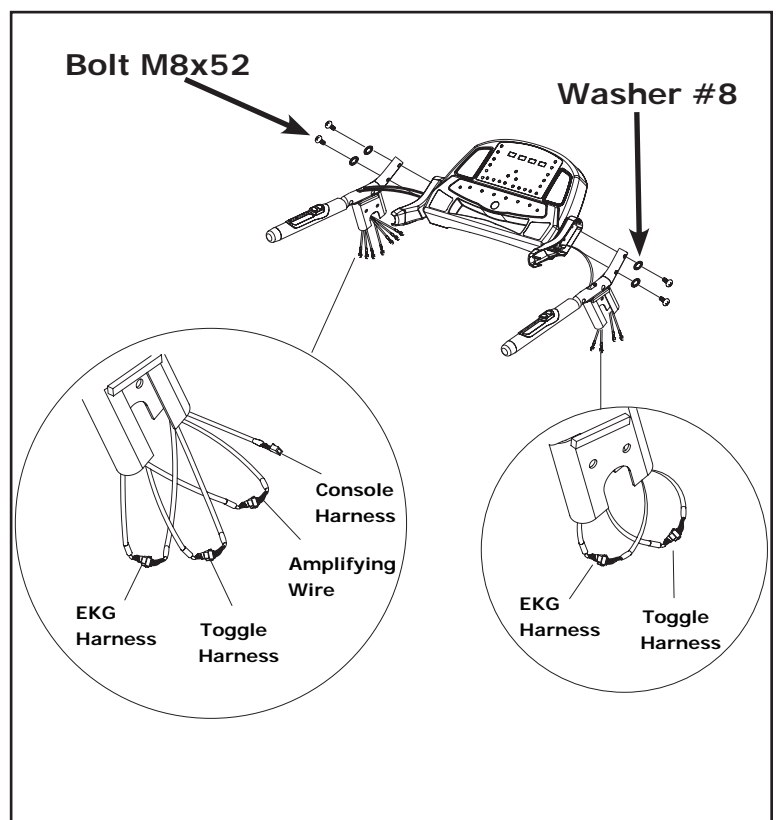

Figure 4: Console Assembly

5. Connect the console harness together. One side of harness is coming from the left upright. The other end is coming from the console.

Connect the amplifier harness together. One side of harness is coming from the left upright. The other end is coming from the console.

Attach the console onto the uprights by sliding into the uprights.

NOTE: Make sure that the console harness is inside of the upright and not being pinched.

Secure the console to the uprights using two bolts M10x25 and two washers #10 per side.

IMPORTANT PLEASE NOTE:

Tighten all hardware installed in Step 2 through Step 5.

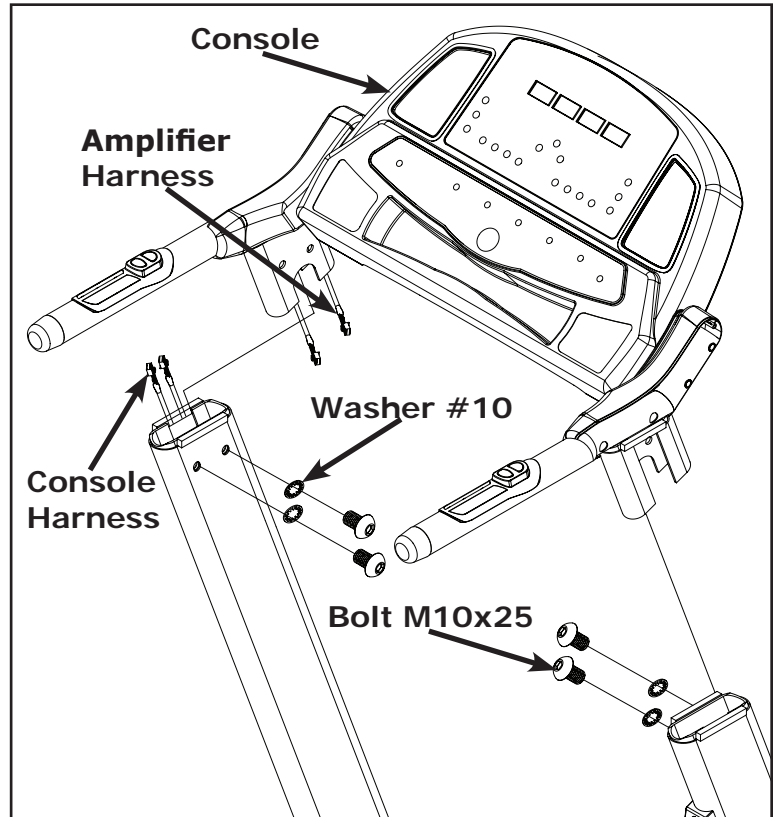

Figure 5: Securing Console Assembly to Uprights

6. Locate the left and right covers. Secure the covers to the console using three screws on each side.

NOTE: Make sure not to pinch or screw through any wires when securing the left handlebar.

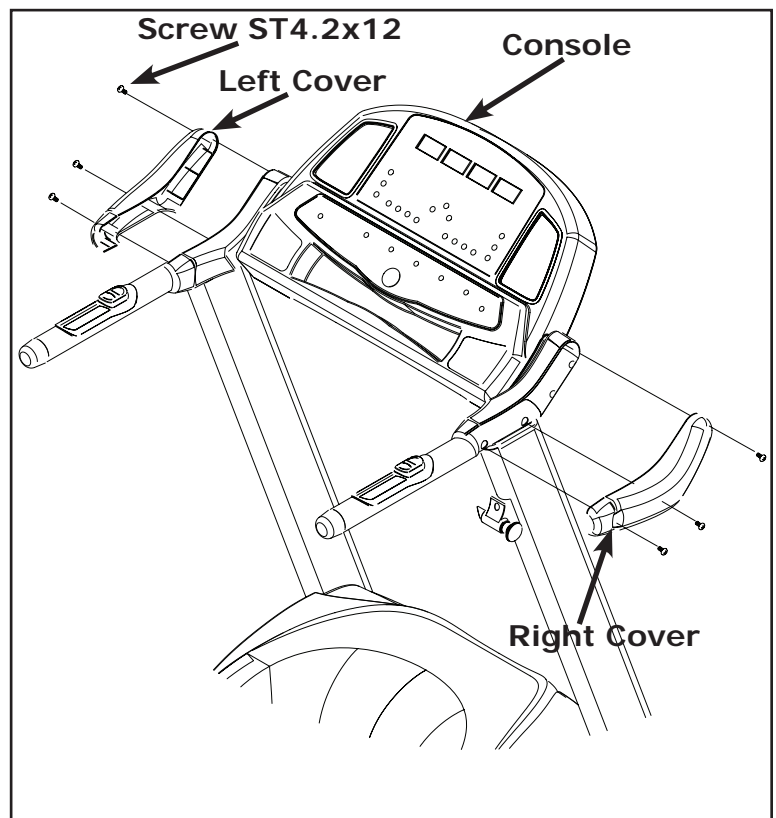
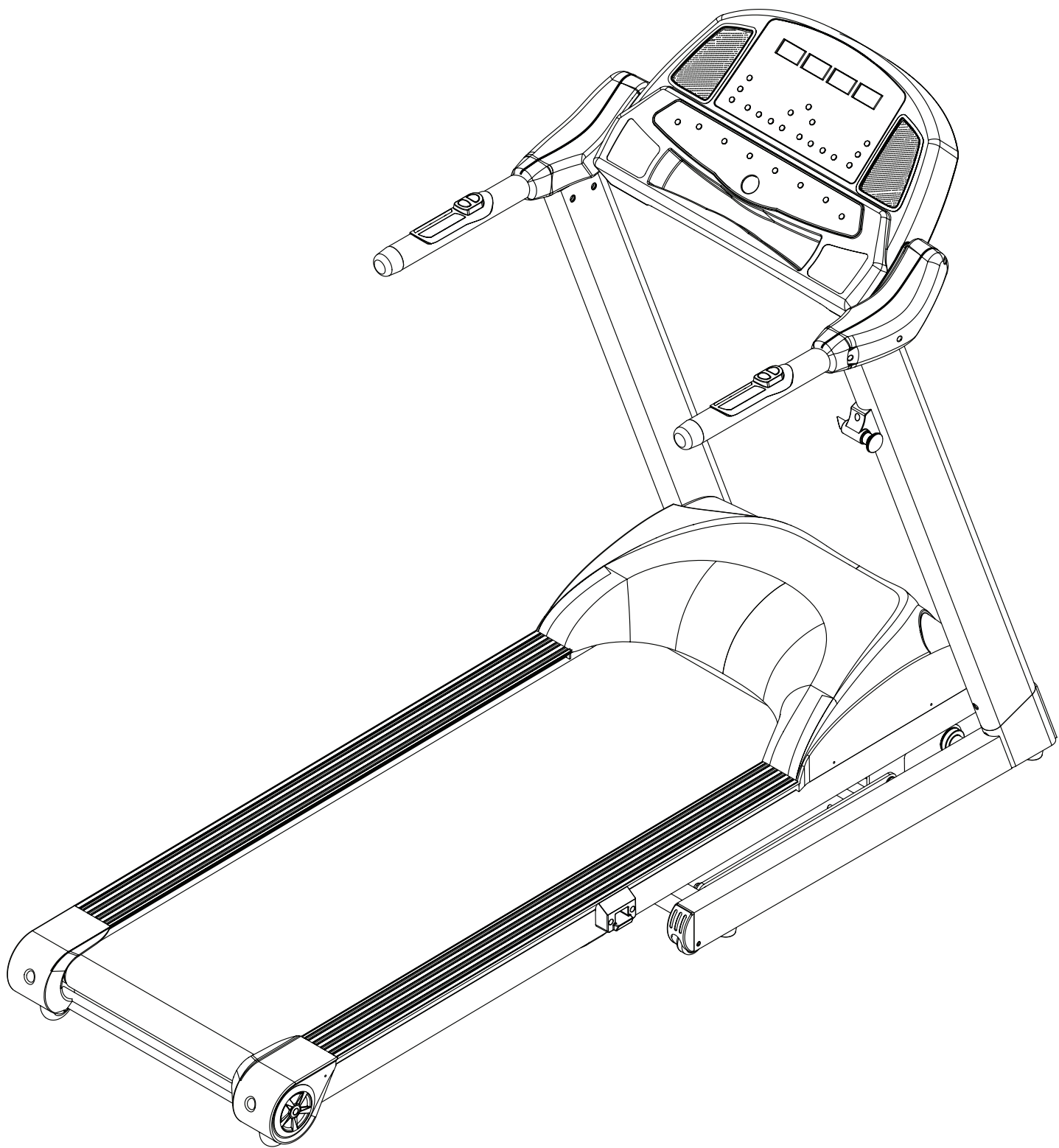

Figure 6: Cover Installation



Congratulations!
You have completed the assembly of your new KF-2.5T Treadmill!
Please remove the treadmill out of the box.

Moving Instructions



Caution! To Avoid The Risk Of Injury, Never Attempt To Move The Treadmill While It Is In The Unfolded Operating Position.

With the treadmill in the folded locked position (safety latch is engaged) grasp the handlebars and simply start rolling to desired location. Do not attempt to move the treadmill over an uneven or rough surface.

Power Requirements

Improper connection of the equipment grounding connector can result in a risk of an electric shock. Check with a qualified electrician or service man if you are in doubt as to whether the product is properly grounded. Do not modify the plug provided with the product. If plug will does not fit into the outlet, have a proper outlet installed by a qualified electrician.

This treadmill can be seriously damaged by sudden voltage changes in your home's electrical power. Voltage spikes, surges, and noise interference can result from weather conditions or from other appliances being turned on or off. To reduce the possibility of treadmill damage, always use a dedicated **surge protector** (not included) with your treadmill.

Surge protectors can be purchased at most hardware stores. The manufacturer recommends a single outlet surge protector with UL 1449 rating as a Transient Voltage Surge Suppressor (TVSS) with UL suppressed voltage rating of 400V or less and an electrical rating of 120VAC, 15 amps.

This treadmill must be grounded to reduce the risk of electrical shock. Grounding provides a path of least resistance for electric current should the treadmill malfunction. This treadmill comes with an electrical cord with an equipment-grounding conductor and a grounding plug. Always plug the power cord into a surge protector, and plug the surge protector into an appropriate outlet that is properly installed and grounded in accordance with all local codes and ordinances. Do not connect other equipment to the surge protector or this could cause permanent damage to your treadmill.

This product is for use on a nominal 120-volt circuit and has a grounding plug that looks like the plug illustrated in the drawing below.

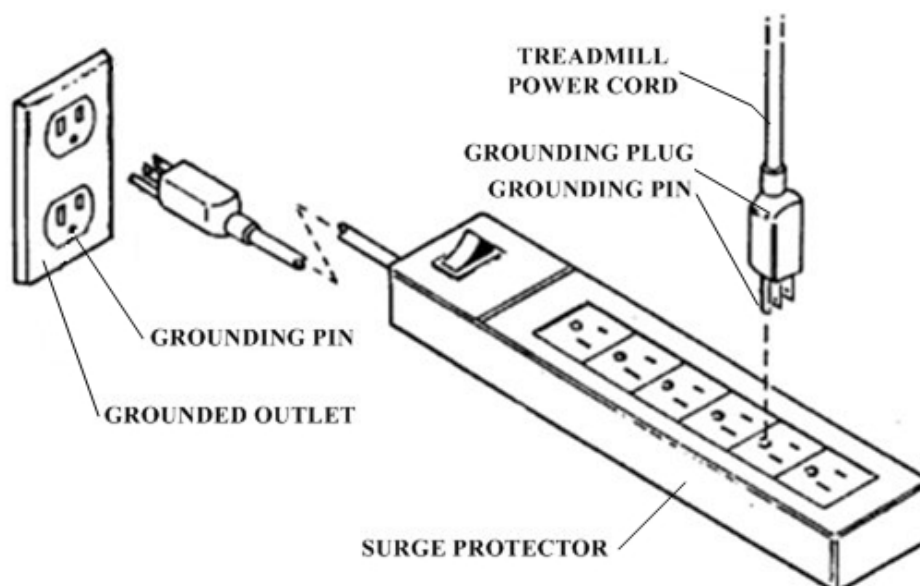

Console Instructions

OVERVIEW

There are four display windows on the control panel to provide feedback information.

TIME/PACE

TIME: Indicates elapsed time after pressing start in minutes and seconds (0-99 minutes, 0-59 seconds)

PACE: Indicates estimated amount of time needed to complete 1 mile based on current speed. Will be displayed in the TIME Window while the SPEED/PACE Window displayed "PACE".

CALORIES / DISTANCE WINDOW

CALORIES: Indicates estimated calories used based on 150 lb. person at the indicated speed, incline, and time.

DISTANCE: Indicates Miles or Kilometers traveled in .01 increments up to 9.99 and .1 increments starting at 10.0

INCLINE / PULSE WINDOW

INCLINE: Indicates incline in percent of grade 0-12% in 0.5 increments.

PULSE: Indicates the estimated heart rate of the user when the pulse grips are held.

Note: It may take several seconds for the electronics to detect and display an accurate heart rate reading.

SPEED

SPEED: Indicates MPH (miles per hour) or KPH (kilometer per hour) in .1 increments 0.6-10MPH.

MP3 Input

The KF-2.5T is equipped with an mp3 input which allows you to listen to the music stored on your mp3 player through the integrated speakers on the console.

To use, simply take one end of the mp3 cable provided and plug it into the output of the mp3 player. Plug the other end of the mp3 cable into the mp3 input of the treadmill. You will see  next to the input. You will need to use the controls on the mp3 player to change songs and control the volume.

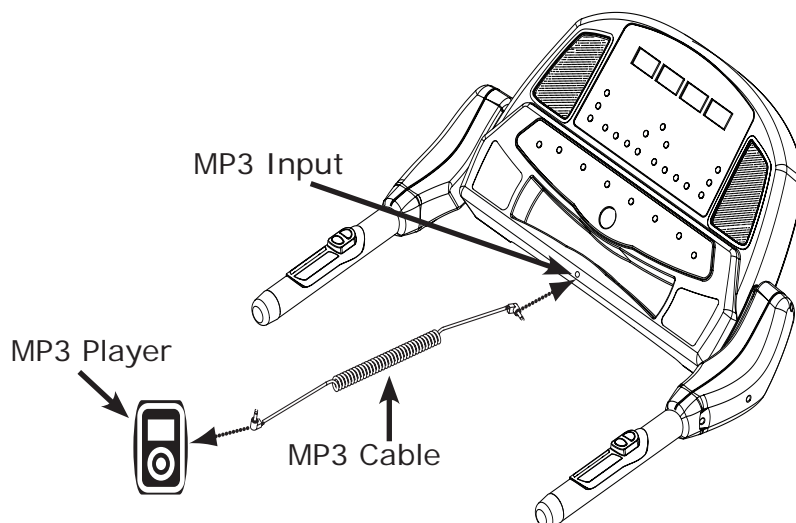

Console Instructions

CONSOLE BUTTONS

POWER

This button is used to turn the treadmill on and off.

START/STOP

This button is used to start or stop the current program.

PAUSE

This button is used to stop your workout temporarily, and to continue from where you left off when you are ready.

PROGRAM

This button is used to edit the settings of the desired program before it is started.

PROGRAM UP AND DOWN

These buttons are used to cycle through to the desired program.

INCLINE + and -

These buttons are used to adjust the incline value during the workout. These buttons are also used to adjust the values when setting up your workout.

SPEED + and -

These buttons are used to adjust the speed of the treadmill during workout. These buttons are also used to adjust the values when setting up your workout.

ONE TOUCH BUTTONS

The one touch buttons allow you to choose a preset speed and incline easily.

To use the one touch feature: Press one of the one touch numbers (2-8). You can select from the incline set of buttons or the speed set of buttons if you would like to change the speed or incline of your workout.



PROGRAM OPERATION

QUICK START / MANUAL MODE (P1)

1. Plug into a surge protector outlet. Attach the **Safety Key** to the treadmill console.
2. Stand on the treadmill and straddle belt. Attach safety key clip to your clothes.
3. Press POWER button. There will be an eight (8) second delay after pressing the POWER button before data can be entered.
4. Press START/STOP button. Belt will begin to move after 4 seconds. Step on belt slowly after the belt starts moving. Speed or incline may be adjusted by using the appropriate + (increase) or – (decrease) button.
5. To end your workout, press START/STOP button. Belt will gradually slow to zero.
6. To pause your workout, press PAUSE.
7. To re-start after pausing: Press the PAUSE button. **WARNING: THE TREADMILL BELT WILL RESUME AT THE SPEED THE TREADMILL WAS MOVING BEFORE PAUSING.**

PROGRAM MODE

Plug treadmill into a surge protector outlet. Attach the Safety Key on to the treadmill console.

1. Stand on the treadmill and straddle belt. Attach safety key clip to your clothes.
2. Press POWER button. There will be an eight (8) second delay before data can be entered.
3. There are thirteen (13) pre-set and two (2) user profile programs. Refer to the following pages for program overview that includes Speed and Incline setting for each program. Press the PROGRAM UP or DOWN button to select which program you wish to use. Press PROGRAM to confirm selection.
4. Press START/STOP button. Belt will begin to move after 4 seconds. Step on belt slowly after the belt starts moving.

COOL DOWN

At the end of the program, the unit will enter a Cool Down program with a fixed time of 2 minutes. At this time, the TIME window will continue to show the entered Time. The Speed and Incline will go to 1/2 of their current settings. For example, If you are running at 5 MPH with an Incline of 4%, when the unit goes into Cool Down, Speed will decrease to 2.5MPH and the Incline will decrease to 2%. After the 2 minute Cool Down, the unit will self power down.

NOTE: If any button is pressed during the 2 minute Cool Down period, the unit will change to Manual Mode (see P1). At this time, full manual control of treadmill settings such as Speed and Incline are available to the User.

TIME GOAL (P2):

Program allows user to set desired TIME of workout. Once the desired TIME is accomplished, the treadmill will enter Cool Down.

1. Press PROGRAM UP button or PROGRAM DOWN button until P2 is selected. Press PROGRAM. The TIME window will blink. Use the SPEED + or – arrows or toggles to select your workout time. Press PROGRAM.
2. The SPEED window will then blink. Use the SPEED + or – arrows or toggle to select the speed for your workout. Press PROGRAM.
3. The INCLINE window will then blink. Use the INCLINE + or – arrows or incline toggles to set your workout incline. Press PROGRAM.
4. To start, press the START/STOP button.

DISTANCE GOAL (P3):

Program will allow user to set desired DISTANCE for workout. Distance will count up to desired Distance. Once the desired DISTANCE is accomplished, the treadmill will enter Cool Down.

1. Press PROGRAM UP button or PROGRAM DOWN button until P3 is selected. Press ENTER.
The DISTANCE/CALORIE window will blink. Use the SPEED + or – arrows or toggles to select your workout distance. Press PROGRAM.
2. The SPEED window will then blink. Use the SPEED + or – arrows or toggle to select the speed for your workout. Press PROGRAM.
3. The INCLINE window will then blink. Use the INCLINE + or – arrows or incline toggles to set your workout incline. Press PROGRAM.
4. To start, press the START/STOP button.

CALORIES GOAL (P4):

Program allows user to set desired CALORIES of workout. Once the desired CALORIES is accomplished, the treadmill will enter Cool Down.

1. Press PROGRAM UP button or PROGRAM DOWN button until P4 is selected. Press PROGRAM.
The DISTANCE/CALORIES window will blink. Use the SPEED + or – arrows or toggles to select your workout CALORIES. Press PROGRAM.
2. The SPEED window will then blink. Use the SPEED + or – arrows or toggle to select the speed for your workout. Press PROGRAM.
3. The INCLINE window will then blink. Use the INCLINE + or – arrows or incline toggles to set your workout incline. Press PROGRAM.
4. To start, press the START/STOP button.

5K RUN AND 10K RUN (P5 - P6)

Pre-set programs will allow user to workout for a preset DISTANCE of 5K (3.1 Miles) and 10K (6.2 Miles). Once the pre-set DISTANCE is reached, the treadmill will enter Cool Down.

1. Press PROGRAM UP button or PROGRAM DOWN button until P5, 5k run, or P6, 10k run, is selected. Press PROGRAM. The SPEED window will blink. Use the SPEED + or – arrows or toggles to select your workout SPEED. Press PROGRAM.
2. The INCLINE window will then blink. Use the INCLINE + or – arrows or incline toggles to set your workout incline. Press PROGRAM.
3. To start, press the START/STOP button.

PROGRAMS (P7 - P13)

These are pre-set programs with predefined values.

1. Press PROGRAM UP or PROGRAM DOWN until desired program is selected.
2. The TIME window will blink. Use the SPEED + or - arrows or toggles to select your workout TIME. Press PROGRAM.
3. The SPEED window will then blink. Use the SPEED + or – arrows or toggle to select the speed for your workout. Press PROGRAM.
4. To start, press the START/STOP button.

Please refer to **pages 17-18** for Program Profiles.

NOTE: P10 is a Random program. When selected, the unit will adjust the incline to a random setting every minute.

CUSTOM PROGRAMS (P14, P15)

These are fully customizable programs that will record changes made to Speed and Incline as you run through the program. These changes made to Speed and Incline will be used in subsequent runnings of the program.

1. Press PROGRAM UP button or PROGRAM DOWN button until desired program is selected. Press PROGRAM. The TIME window will blink if the program is ready to be programmed, and be solid if the program has already been programmed. If the program has been programmed but you wish to re-program values, press the Pause key at this time and the Time window should begin flashing, indicating that the program is ready to be re-programmed.
2. When the Time window is flashing, use the SPEED + or – arrows or toggles to select your workout time. Press PROGRAM.
3. The SPEED window will then blink. Use the SPEED + or – arrows or toggle to select the initial speed for your workout. Press PROGRAM.
4. The INCLINE window will then blink. Use the INCLINE + or – arrows or incline toggles to set your initial workout incline. Press PROGRAM.
5. To start the program, press the START/STOP button.
6. As the program runs, changes made to Speed and Incline will be recorded every 15 seconds, and these changes will be used in subsequent operation of the program.

PROGRAM PROFILES

HILLS

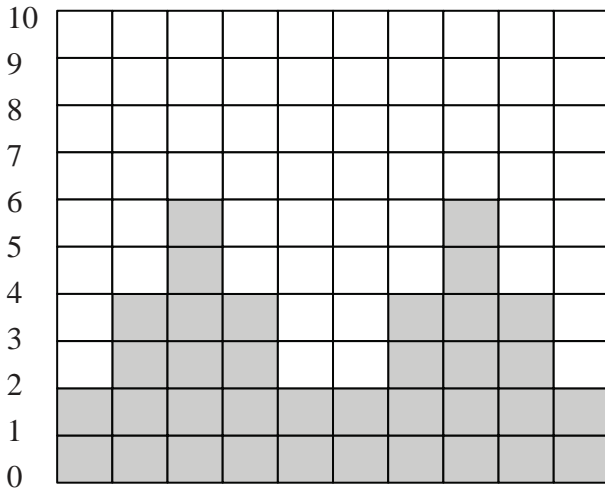

P7 - Each time segment will last 1 minute, and will either increase or decrease the incline. This program will repeat this cycle until programmed time is accomplished.

MOUNTAIN CLIMB

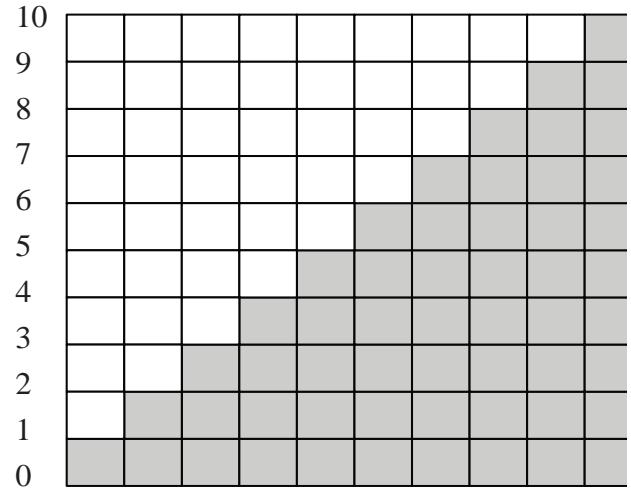

P8 - Each time segment will last 1 minute, and will increase incline. This program will repeat this cycle until programmed time is accomplished.

MOUNTAIN

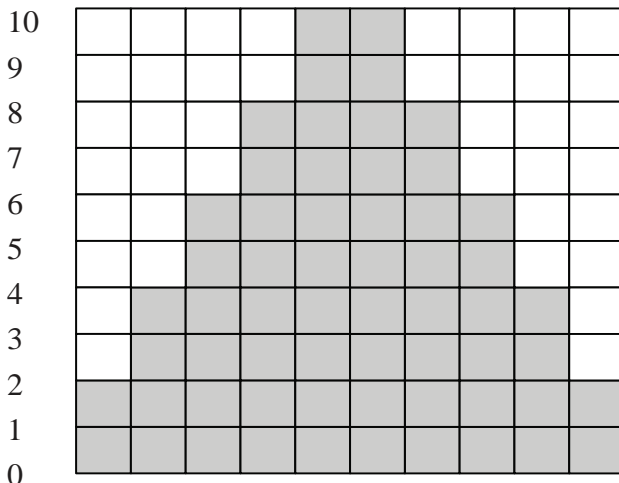

P9 - Each time segment will last 1 minute, and will increase or decrease incline. This program will repeat this cycle until programmed time is accomplished.

INTERVAL 1

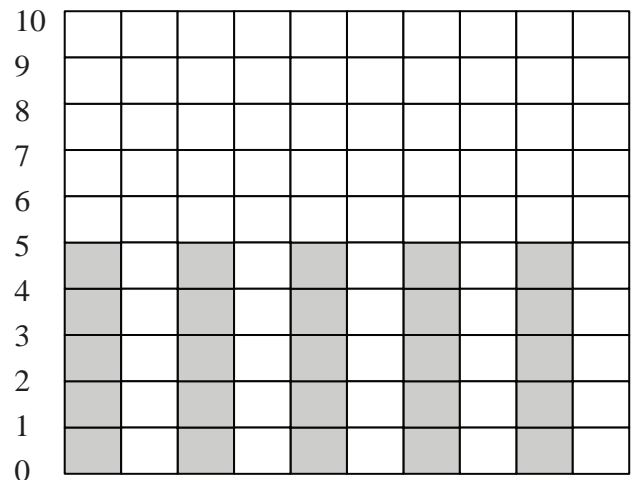

P11 - Each time segment will last 1 minute, and will increase or decrease incline. This will alternate between 5% and 0% Incline. This program will repeat this cycle until programmed time is accomplished.

INTERVAL 2

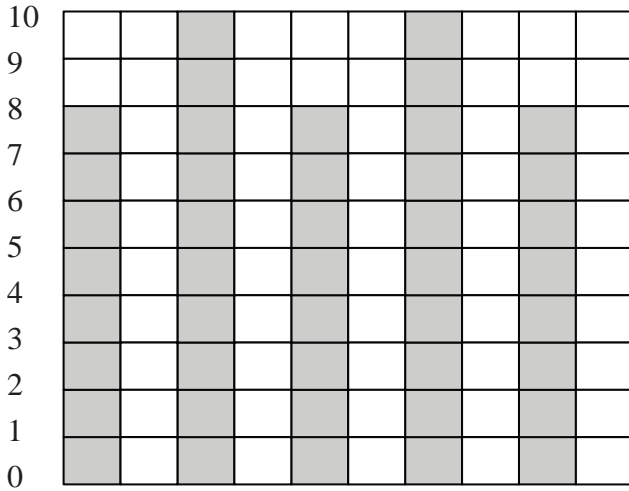

P12 - Each time segment will last 1 minute, and will increase or decrease incline. This program will alternate between 8%, 0%, and 10%. This program will repeat this cycle until programmed time is accomplished.

ESCALATING INTERVAL

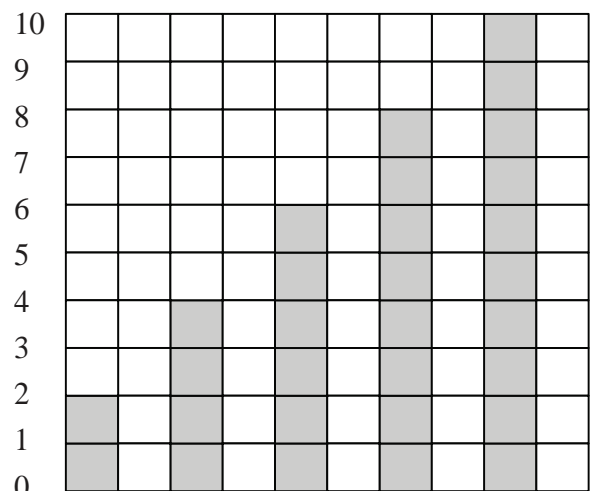

P13 - Each time segment will last 1 minute, and will increase or decrease incline. This program will alternate between 2%, 0%, 4%, 0%, 6%, 0%, 8%, 0%, 10%, and 0%. This program will repeat this cycle until programmed time is accomplished.

Monitoring Your Heart Rate



Monitoring Your Heart Rate

To obtain the greatest cardiovascular benefits from your exercise workout, it is important to work within your target heart rate zone. The American Heart Association (AHA) defines this target as 60%-75% percent of your maximum heart rate.

Your maximum heart rate may be roughly calculated by subtracting your age from 220. Your maximum heart rate and aerobic capacity naturally decreases as you age. This may vary from one person to another, but use this number to find your approximate effective target zone. For example, the maximum heart rate for an average 40 year-old is 180 bpm. The target heart rate zone is 60%-75% of 180 or 108-135 bpm. See **Fitness Safety** below.

Before beginning your workout, check your normal resting heart rate. Place your fingers lightly against your neck, or against your wrist over the main artery. After finding your pulse, count the number of beats in 10 seconds. Multiply the number of beats by six to determine your pulse rate per minute. We recommend taking your heart rate at these times; at rest, after warming up, during your workout and two minutes into your cool down, to accurately track your progress as it relates to better fitness.

During your first several months of exercising, the AHA recommends aiming for the lower part of the target heart rate zone-60%, then gradually progressing up to 75%. According to the AHA, exercising above 75% of your maximum heart rate may be too strenuous unless you are in top physical condition. Exercising below 60% of your maximum will result in minimal cardiovascular conditioning.

Check your pulse recovery rate – If your pulse is over 100 bpm five minutes after you stop exercising, or if it's higher than normal the morning after exercising, your exertion may have been too strenuous for your current fitness level. Rest and reduce the intensity next time.

Fitness Safety *The target heart rate chart indicates average rate zones for different ages. A variety of different factors (including medication, emotional state, temperature and other conditions) can affect the target heart rate zone that is best for you. Your physician or health care professional can help you determine the exercise intensity that is appropriate for your age and condition.*

(MHR) = Maximum Heart Rate
(THR) = Target Heart Rate

220 - age = maximum heart rate (MHR)
MHR x .60 = 60% of your maximum heart rate.
MHR x .75 = 75% of your maximum heart rate.
For example, if you are 30 years old, your calculations will be as follows:

220 - 30 = 190
190 x .60 = 114 (low end or 60% of MHR)
190 x .75 = 142 (high end or 75% of MHR)
30 year-old (THR) Target Heart Rate would be 114-142

See Heart Rate Table (on next page) for additional calculations.

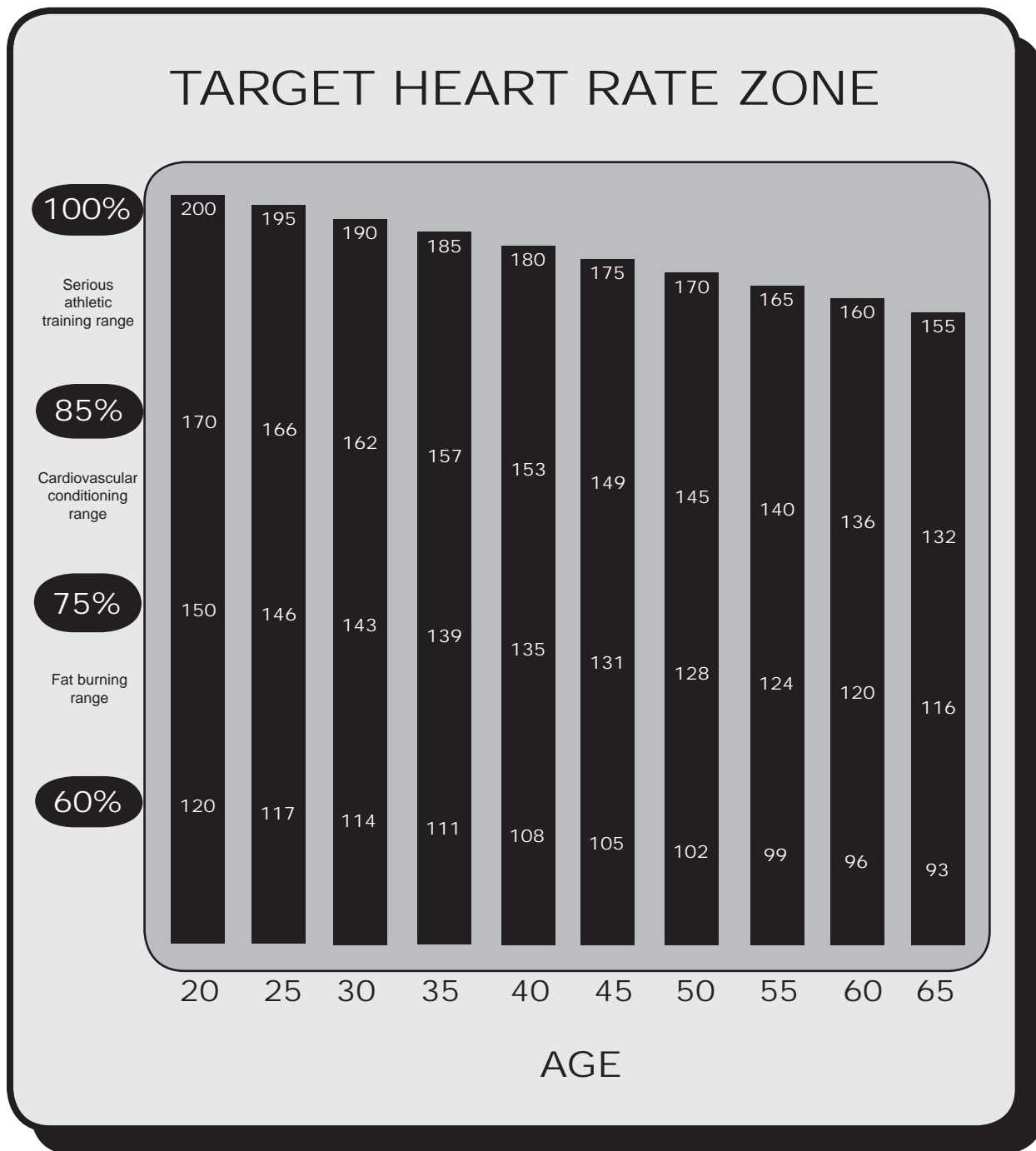

Workout Information

Frequency, Intensity, Time, Target Heart Rate Zone

The exercise practices include four major variables: frequency, intensity, time, target heart rate zone. A continuous workout will help to improve your cardiovascular functions and increase the ability of your muscles to obtain the oxygen and nutrition. A good workout provides a greater advantage to extend the endurance of muscle and body flexibility.

Frequency: How Often Should You Exercise

Three to five times a week is highly suggested to improve your cardiovascular and muscle fitness.

Intensity: How Hard Should You Exercise

The intensity of an exercise is reflected in your heart rate. Exercise must be sufficient to strengthen your heart muscle and condition your cardiovascular system. Only your doctor or an authorized coach can prescribe the target training heart range appropriate for your particular needs and physical condition.

Start with an exercise that stimulates you to breathe more deeply. Alternate periods of moderate and easy exercise to help your body adapt to new levels of exertion without unnecessary strain. The inability to maintain a smooth, rhythmic motion is a sign that your pace and/or your elevation is too high. If you feel out of breath before you have exercised 12 minutes, you are probably overdoing it.

As your fitness level improves, you will need to increase your workload to reach your target heart rate. The first increase may be necessary after two to four weeks of regular exercise. Never exceed your target heart rate zone.

Weight Management

Consistent aerobic exercise will help you change your body composition by lowering your percentage of body fat. For weight control, how long and how often you exercise is more important than how hard you exercise.

- ◆ Exercise at least four to five times a week.
- ◆ Reach and maintain 60-75% of your maximum heart rate with moderate exercise.
- ◆ Exercise for 30-45 minutes at 60-65% of your target heart rate.

Here are some tips to achieve your weight management goal.

- ◆ Consume most of your dietary calories at breakfast and lunch, and eat a light dinner.
- ◆ Do not eat anything near the bedtime.
- ◆ Moderate exercise will help suppress your appetite.
- ◆ Take regular breaks and rests to help increase metabolism.

Warning!

If you have any questions or concerns about your target heart rate, consult your physician. Medications may affect your heart rate. Stop exercise if: you feel faint or dizzy, acute illness (cold or fever), any pain or tightness in your chest, an irregular heartbeat, or if you exceed your maximum heart rate set by your physician.

Workout Information

Exercise Practice Procedures

Warm-Up → Workout → Cool Down

A good warm-up will help you perform better and will decrease the aches and pains. The warm-up prepares your muscles for exercise and allows your oxygen supply to ready itself for what is to come. Experience tells us that muscles perform best when they are warmer than normal body temperature. This normally takes about 5-10 minutes when you begin to perspire on your brow and breathe more deeply.

Note: The older you are, the longer your warm-up period should be.

Workout: Brisk and Rhythmic Exercise

A workout trains your heart, lungs, and muscles to be more efficient. Increase exercise in response to your heart rate to train and strengthen your cardiovascular system. Concentrate on moving your arms and legs smoothly. Walking naturally and avoid jerking motions like pulled muscles, sprained joints, and loss of balance.

If you cannot sustain 12 continuous minutes in your target heart rate zone, then, exercise several times a day to get into habit. Try to reach and maintain 60-65% of your maximum heart rate. Alternate exercise with periods of rest until you can sustain 12 continuous minutes of exercise at 60-65% of your maximum heart rate. Best start with a target 3-4 minutes, then, increase it gradually.

If you can sustain 12 but not 20 continuous minutes of exercise in your target heart rate zone:

- ♦ Exercise 3-5 days a week. Rest at least two days per week.
- ♦ Try to reach and maintain 65-70% of your maximum heart rate with moderate rhythmic exercises.
- ♦ Begin with 12 continuous minutes. Increase your time by one to two minutes per week until you can sustain 20 continuous minutes.

If you can sustain 20 minutes continuously in your target heart rate zone, begin to increase the length and intensity of your workout:

- ♦ Exercise 4-6 days a week or on alternate days.
- ♦ Try to reach and maintain 70~85% of your maximum heart rate with moderate to somewhat hard exercise.
- ♦ Exercise 20-30 minutes.

WARNING: These strategies are intended for average healthy adults. If you have pain or tightness in your chest, an irregular heartbeat, shortness of breath or you feel faint or have any discomfort when you exercise, STOP. Consult your physician before continuing. Remember, every workout should begin with warmup and finished with cool down.

Cool down: Slow and Relaxed Exercise

The cool down allows your body's cardiovascular system to gradually return to normal and should be roughly 5-10 minutes. Lower your exercise intensity gradually, and when your heart rate has returned below 110 beats per minutes, you can end your workout.

Warm Up Exercises

EXERCISE GUIDELINES

WARNING! Before beginning this or any exercise program, you should consult your physician. This is especially important for individuals over the age of 35 or individuals with pre-existing health problems.

Flexibility is a key to fitness. Stretch all major muscle groups at least two to three times per week after a 5 to 10 minute warmup. Stretch just to the point of a gentle tug. If you have back, joint, or other health problems, talk to your doctor first.



Prone on Elbows

Lie on your stomach with your feet together. Rest on your forearms with your elbows directly under your shoulders. Relax lower back and abdomen into floor. Hold for 30-60 seconds or until muscles feel looser.



Supline Lumbar Rotation

Lie on your back with your knees bent. Keeping your knees together and your shoulders against the floor, roll your knees to one side until you feel a stretch in your back or hip. Hold for 30-60 seconds or until muscles feel looser. Repeat on opposite side.



Knees to Chest

Lie on your back. Bend your knees, and lift your feet off the floor. Grasp your knees with your arms and pull your knees toward your chest. Hold for 20 seconds. Repeat three to five times.



Cat and Camel

Rest on your hands and knees. Round your back by contracting your abdominal muscles and tucking in your pelvis; hold for five seconds. Then allow your back to sag toward the floor as you lift your chest and head; hold for five seconds. Repeat the combination 10 times



Cervical Side Bends

Tilt your head gently toward one shoulder, keeping your shoulders level and your face pointed straight ahead. Hold for five seconds, then tilt your head toward the other shoulder and hold for five seconds. Repeat five times on each side.

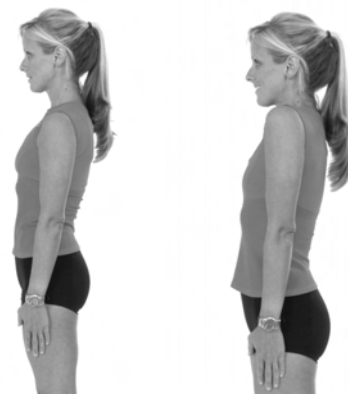

Shoulder Circles

In a smooth, continuous motion, make a circle with your shoulders: Raise them up towards your ears, pull them together behind you, lower them to a resting position, then roll them forward. Repeat 10 times.

Warm Up Exercises

WARNING! Before beginning this or any exercise program, you should consult your physician. This is especially important for individuals over the age of 35 or individuals with pre-existing health problems.



Wrist Extensor

Extend your right arm in front of you with your palm up and your elbow straight. Point your fingertips toward the floor by bending at the wrist. Using your left hand, pull the back of your right hand toward you gently. Hold for 20 seconds; repeat three to five times with each arm.



Wrist Flexor

Extend your right arm in front of you, palm down, elbow straight. Point your fingertips toward the floor by bending at the wrist. Using your left hand, pull your right palm toward you gently. Hold for 20 seconds; repeat three to five times with each arm.



Triceps Stretch

Place your right hand behind your head, palm facing your head. With your left hand, grasp your right elbow and pull downward until you feel a stretch in the back of your right arm. Hold for 20 seconds; repeat three to five times with each arm.



One-Arm Pectoralis Stretch

Stand against an immobile structure like a wall or a tree. While facing the wall, raise your right hand out to your side at chest height, palm against the wall. Turn your body toward the left, away from the wall and your extended arm, until you feel a stretch. Hold for 20 seconds; repeat three to five times with each arm.



Piriformis Stretch

Lie on your back. Bend your right knee and lift it halfway to your chest. Grasp your knee with your left hand and pull it toward your left shoulder, keeping both buttocks against the floor. Hold for 20 seconds; repeat three to five times with each leg.



Groin (Adductors) Stretch

Sitting with your back straight, bring the soles of your feet together. Let your knees lower toward the floor. Hold for 30-60 seconds or until muscles feel looser.

Warm Up Exercises

WARNING! Before beginning this or any exercise program, you should consult your physician. This is especially important for individuals over the age of 35 or individuals with pre-existing health problems.



Calf Stretch

Face a solid structure such as a wall with your left foot ahead of your right, toes straight ahead. Bend your left knee, press your hips forward, and lean into the wall. Keep both heels down, your right leg straight, and your left knee over your ankle. Hold for 20 seconds; repeat three to five times with each leg.



Standing Quadriceps Stretch

Steady yourself with one hand. With the other, grab outside leg at ankle, keeping body straight from knee to hip. Gently pull foot up and towards the buttocks until you feel a stretch along the front of the thigh. Thigh should be pulled straight back and not drift to outside. Hold 20-30 seconds. For variation, grab opposite ankle (i.e., grab right ankle with left hand). Do two to three repetitions per leg.



Achilles Stretch

Face the wall with your left foot ahead of your right, toes straight ahead. Bend both knees, press your hips forward, and lean into the wall. Keep both heels down and both knees in line with your feet. Hold for 20 seconds; repeat three to five times with each leg.

Calibration Sequence



Do not attempt to calibrate the treadmill unless an Error Code is present. See Error Messages (page 29).

Our treadmill is equipped with a software package that will perform a calibration sequence unique to your specific model number.

Please perform the following steps to calibrate the **Keys Fitness KF-2.5T Treadmill**.

1. Unplug power cord from outlet strip.
2. Attach Safety Key to console.
3. Plug power cord into outlet strip.
4. Initiate calibration sequence. To do so, press the Program Up, Program Down, and the Program button simultaneously for about 3 seconds.
5. **CL11** should appear in the Time window. Press Pause.
Note: During the calibration sequence, the Time window will display which step you are at in the process (C21, C22, C23 and so on).
6. **CL21:** MPH or KPH will be flashing in the Time window, pressing the Speed +/- button will toggle options. Choose **MPH** (KPH), press Program.
7. **CL22:** 8, 10, or 12 (13, 16, or 20 in KPH mode) will be displayed in the Speed window, pressing the Speed +/- button will toggle options. Choose **10** (or 16 for KPH mode), press Program.
8. **CL23:** FFF, UUU, or HHH will be displayed in the Speed window, pressing the Speed +/- button will toggle options. Choose **UUU**, press Program.
9. **CL24:** 111 or 222 will be displayed in the Speed window, pressing the Speed +/- button will toggle options. Choose **222**, press Program.
10. **CL25:** "nHr" will be displayed in the Speed window, press Program.
11. **CL26:** OPA or OPI will be displayed in the Speed window, pressing the Speed +/- button will toggle options. Choose **OPA**, press Program.
12. **CL27:** Blank (nothing) press Program.
14. At this time, make sure you are not standing on the walking belt, as the machine will automatically initiate belt movement and run through a complete calibration and diagnostic routine. Press **Program**. Belt will begin to move. Unit will begin self-calibration.
15. When Speed and Incline calibration has finished, press Power button **twice**, display should be blank, and treadmill should be ready for use.

To avoid possible damage to the treadmill and the possibility of injury, do not operate the treadmill until the problem is corrected. Call Keys Fitness Customer Service at 888-340-0482 if problem persists.

Change to MPH or KPH

Your treadmill will operate in British Units (miles per hour) or International Units (kilometers per hour). All treadmills are calibrated at the factory for British Units (miles per hour). To change the display to read in kilometers, follow the steps described here:

1. Turn power OFF on the console. Attach the magnet safety key to the console.
2. Press the Program Up, Program Down, and the Enter button simultaneously for about 3 seconds.
3. CL11 should appear in the TIME window.
4. Pressing the SPEED +/- button will activate your choice. Press the POWER button to accept.

Belt Adjustment

WARNING! Do not over-tighten rollers! This will cause premature roller bearing failure!

Belt adjustment and tension performs two functions: adjustment for tension and centering. Your new treadmill comes pre-adjusted from the factory for tension and centering. Please follow the procedures below if the belt shifts to the left or right while walking:

WALKING BELT IS SHIFTING TO THE LEFT

(Diagram 1)

First, turn treadmill on to run at 1 mph. Using the hex key provided, turn the left rear roller adjustment bolt $\frac{1}{4}$ turn in the clockwise direction. Next, run the treadmill at 2.5 mph. You should see the belt start to correct itself by moving back toward the center. Repeat the above procedure until the walking belt is centered. It may be necessary to set walking belt tension once you have completed this procedure if the belt feels like it is slipping while walking. Refer below to the "Walking Belt Slipping" instructions.

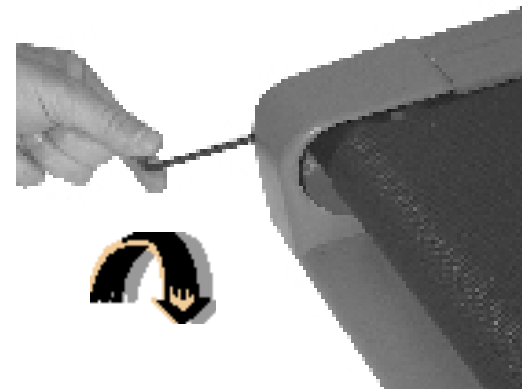

Diagram 1

WALKING BELT IS SHIFTING TO THE RIGHT

(Diagram 2)

First, turn the treadmill on to run at 1 mph. Using the hex key provided, turn the right rear roller adjustment bolt $\frac{1}{4}$ turn in the clockwise direction. Next, run the treadmill at 2.5 mph. You should see the belt start to correct itself, moving back toward the center. Repeat the above procedure until the walking belt is centered. It may be necessary to set walking belt tension once you have completed this procedure if the belt feels like it is slipping while walking. Refer below to the "Walking Belt Slipping" instructions.

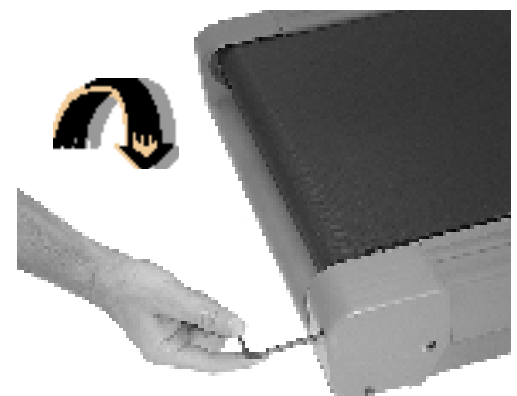

Diagram 2

WALKING BELT IS SLIPPING DURING USE (Diagram 3)

First, unplug the power cord from the surge protector. Using the hex key provided, turn both left and right rear roller adjustment bolts the same distance, usually a $\frac{1}{4}$ turn, in the clockwise direction. Plug the power cord back into the surge protector and run the treadmill at 2.5 mph. You should now walk on the belt to determine if the belt is still slipping. Repeat the above procedure until the walking belt is not slipping. The tension should be just tight enough not to slip.

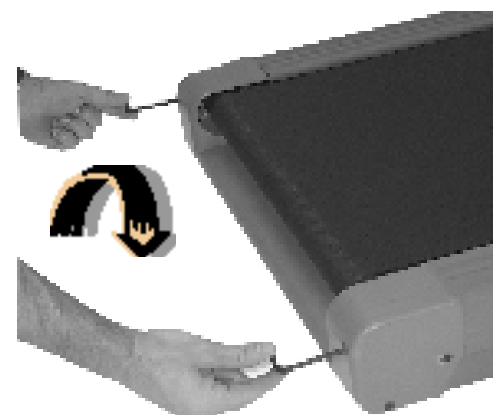

Diagram 3

Note: Turning the hex key clockwise brings the rear rollers and belt towards you.

Turning the hex key counter clockwise pushes the rear roller and belt away from you.

Maintenance Instructions



WARNING! Before performing any maintenance to your treadmill, always unplug the power cord from the surge protector.

CLEANING: Routine cleaning of your unit will extend the life of your unit.

WARNING! To prevent electrical shock, be sure the power to the treadmill is OFF and the unit is unplugged from the wall electrical outlet before attempting any cleaning or maintenance.

AFTER EACH WORKOUT: Wipe off the console and other treadmill surfaces with a clean, water dampened soft cloth to remove excess perspiration. USE NO CHEMICALS.

WEEKLY: Use of a treadmill mat is recommended for ease of cleaning. Dirt from your shoes contacts the belt and eventually makes it to underneath the treadmill. Vacuum underneath treadmill once a week.

DECK LUBRICATION: The walking belt has been pre-lubricated at the factory. However, it is recommended that the walking board be checked periodically for lubrication to ensure optimal treadmill performance. Every 30 days or 30 hours of operation, lift the sides of the walking belt and feel the top surface of the walking board as far under as you can reach. If you feel signs of silicone, no further lubrication is required. If it feels dry to the touch, lubrication is needed. Keys Fitness recommends "Lube N Walk" for cleaning and lubricating the treadmill belt and deck. Ask your retailer or call Keys Fitness at 888-340-0482.

TO APPLY LUBRICANT TO THE WALKING BOARD

- 1.) Take foam wand applicator, without lube, and insert it in between the walking belt and deck, exposing the two plastic tabs at either end of the walking belt. Take both tabs and run the wand back and forth along the entire length of your deck. Remove the applicator and prepare for lubrication.
- 2) Apply about a dime's worth of lubrication onto the side of the applicator wand that was not used for removing dirt and debris (step 1). You can add more or less lubricant, depending on your lubrication schedule.
- 3) Insert the wand between the walking belt and deck, exposing the two white plastic tabs at either end of the walking belt.
- 4) Take both of the tabs and run the wand back and forth along the entire length of your deck. You are done until your next scheduled lubrication date.
- 5) Allow the silicone to 'set' for one minute before using the treadmill.

WARNING: Do not over-lubricate the walking board. Excess lubricant should be wiped off with a clean towel.

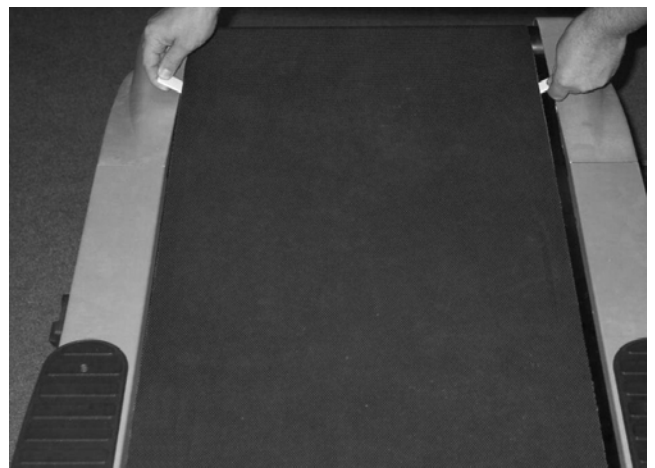
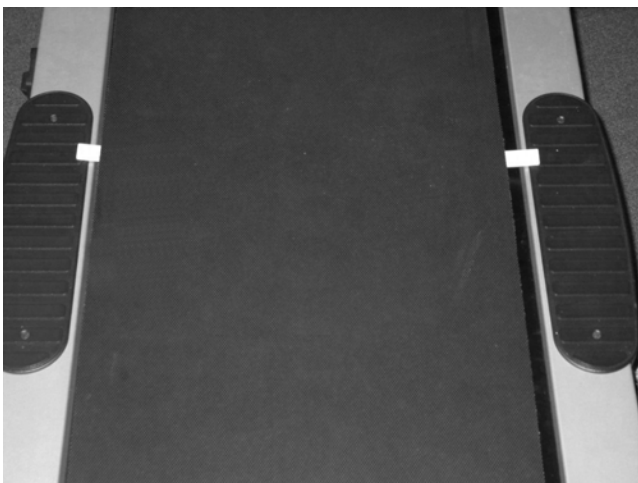

Treadmill Error Messages.

Your treadmill is equipped with a software package that enables error messages to be displayed when there is a problem. The following error codes will be displayed in the console display windows.

Safety Interlock Error Messages

SI 1 - Safety key missing, replace and try again.

SI 2 - Over voltage protection trip. Notify Keys Fitness Customer Service.

Other Error Messages

E11 - Lack of speed feedback data from belt motor. Attempt calibration. See Calibration Sequence section on **page 26** of this Owners Manual for detailed information.

E22 - Under Speed condition detected from the belt motor. Attempt calibration. See Calibration Sequence section for detailed information.

E33 - Over Speed condition detected from the belt motor. Attempt calibration. See Calibration Sequence section for detailed information.

E44 - Lodged key detected at power up, Notify Keys Fitness Customer Service.

To avoid possible damage to the treadmill and the possibility of injury, do not operate the treadmill until the problem is corrected. Call Keys Fitness Customer Service at 888-340-0482.

Treadmill will not start.

1. Is the **Safety Key** inserted into the treadmill Console?
2. Make sure the power cord is plugged into a surge protector, the surge protector is plugged into a properly grounded outlet, and the surge protector is turned on. (Refer to "Power Requirements" on **page 11**.)
3. Check the circuit breaker located on the front of the treadmill. If the switch protrudes, it has tripped. Wait five minutes and then press the switch back in.
4. Check the house electrical breaker box and the circuit breaker for the room where the treadmill is located. If it has tripped, reset or have an electrician replace the breaker in home.
5. Have an electrician check to ensure there is adequate voltage at the outlet.

Treadmill loses power during use.

1. Check the circuit breaker located on the front of the treadmill. If the switch protrudes, it has tripped. Wait five minutes and then press the switch back in.
2. Check the house electrical breaker box and the circuit breaker for the room where the treadmill is located. If it has tripped, reset or have an electrician replace the breaker in home.
3. If the treadmill will not operate, please call Keys Fitness Customer Service at 888-340-0482.

Treadmill walking belt slows during use.

1. Check to make sure the treadmill is securely plugged into an UL-listed surge protector, rated at 15 amps, with a 14-gauge cord of five feet or less and the surge protector is securely plugged into the outlet.
2. If treadmill will not operate, please call Keys Fitness Customer Service at 888-340-0482.

Treadmill walking belt slips or is not centered on rear roller.

1. Refer to "Belt Adjustment" section on **page 27**.
2. Need help? Call Keys Fitness Customer Service at 888-340-0482.

Treadmill Error Messages.

Your treadmill is equipped with a software package that enables error messages to be displayed when there is a problem.

To avoid possible damage to the treadmill and the possibility of injury, do not operate the treadmill until the problem is corrected. Call Keys Fitness Customer Service at 888-340-0482, or see "Error Messages" on page 29 of this Owner's Manual.

KF-2.5T PARTS LIST REV B

Ref #	Part #	Description	Qty	Ref #	Part #	Description	Qty
U1T3	423-00085	MOTOR FRAME, HT-740T/KF-2.5T	1	UAS7	406-00245	COVER, COMPUTER BOTTOM, HT-740T/KF-2.5T	1
UAT4	423-00086	LEFT UPRIGHT, HT-740T/KF-2.5T	1	U1S8	406-00281	CORNER PIECE, LEFT MOTOR COVER, KF-2.5T	1
UAT5	423-00087	RIGHT UPRIGHT, HT-740T/KF-2.5T	1	U1S9	406-00282	CORNER PIECE, RIGHT MOTOR COVER, KF-2.5T	1
UAT6	423-00088	LEFT HANDLEBAR, HT-740T/KF-2.5T	1	U1S10	406-00277	CONNECTION PLATE, LEFT, KF-2.5T	1
UAT7	423-00089	RIGHT HANDLEBAR, HT-740T/KF-2.5T	1	U1S11	406-00278	CONNECTION PLATE, RIGHT, KF-2.5T	1
U1T8	423-00090	FRAME, COMPUTER, HT-740T/KF-2.5T	1	UAS12	406-00248	COVER, LEFT END, HT-740T/KF-2.5T	1
U1G1	419-00038	TUBE, RUNNING BOARD, HT-740T/KF-2.5T	1	UAS13	406-00249	COVER, RIGHT END, HT-740T/KF-2.5T	1
UAB1	419-00039	BOARD, SIDE RAIL FIXED, HT-740T/KF-2.5T	4	UAS14	406-00250	COVER, END CAP, HT-740T/KF-2.5T	2
UAB2	402-00225	WASHER, SIDE RAIL, HT-740T/KF-2.5T	8	U1S15	405-00025	EXTRUSION, HT-740T/KF-2.5T	2
UAJ1	402-00226	BOLT M10*62, HT-740T/KF-2.5T	1	U1S16	406-00251	MOTOR COVER, HT-740T/KF-2.5T	1
UAJ2	402-00227	BOLT M10*45, HT-740T/KF-2.5T	1	U1S17	406-00252	MOTOR COVER FRONT CAP, HT-740T/KF-2.5T	1
UAJ3	402-00228	BOLT M8*30, HT-740T/KF-2.5T	2	UAS18	406-00253	RING SHAPE CAP, HT-740T/KF-2.5T	2
UAJ4	402-00229	BOLT M8*26, HT-740T/KF-2.5T	4	UAS19	406-00254	MOVING WHEEL, HT-740T/KF-2.5T	4
UAJ5	402-00230	BOLT M10*25, HT-740T/KF-2.5T	12	UAS20	406-00255	MOVING WHEEL TUBE CAP, HT-740T/KF-2.5T	2
UAJ6	402-00231	BOLT M8*42, HT-740T/KF-2.5T	4	UAS21	402-00266	FLAT WASHER, HT-740T/KF-2.5T	4
UAJ7	402-00232	BOLT M8*50, HT-740T/KF-2.5T	6	UAS22	406-00256	CUSHION, HT-740T/KF-2.5T	2
UAJ8	402-00233	BOLT M8*80, HT-740T/KF-2.5T	1	UAS23	406-00257	INNER TUBE CAP, HT-740T/KF-2.5T	4
UAJ9	402-00234	BOLT M8*75, HT-740T/KF-2.5T	1	UAS24	406-00258	PLASTIC BEARING, HT-740T/KF-2.5T	2
UAJ10	402-00235	BOLT M8*20, HT-740T/KF-2.5T	4	UAS25	406-00276	WHEEL, HT-760T	2
UAJ11	402-00236	BOLT M6*25, HT-740T/KF-2.5T	8	UAS26	406-00259	WHEEL, HT-740T/KF-2.5T	2
UAJ12	402-00237	BOLT M6-40, HT-740T/KF-2.5T	4	UAS27	404-00019	BELT, HT-740T/KF-2.5T	1
UAJ13	402-00238	BOLT M8*65, HT-740T/KF-2.5T	2	UAS28	406-00261	FOAM TUBE, HT-740T/KF-2.5T	2
UAJ14	402-00239	BOLT M8*40, HT-740T/KF-2.5T	1	UAS29	406-00262	COVER, LEFT PROTECTION, HT-740T/KF-2.5T	1
UAJ15	402-00240	SCREW M6*16, HT-740T/KF-2.5T	4	UAS30	406-00263	COVER, RIGHT PROTECTION, HT-740T/KF-2.5T	1
UAJ16	402-00241	SCREW M6*12, HT-740T/KF-2.5T	2	UAS31	406-00264	COVER, LEFT INNER, HT-740T/KF-2.5T	1
UAJ17	402-00242	SCREW M5*6, HT-740T/KF-2.5T	13	UAS32	406-00265	COVER, RIGHT INNER, HT-740T/KF-2.5T	1
UAJ18	402-00243	SCREW M5*10, HT-740T/KF-2.5T	4	UAS33	406-00266	RUBBER PAD, HT-740T/KF-2.5T	8
UAJ19	402-00244	SCREW ST2.9*9.5, HT-740T/KF-2.5T	13	UAS34	406-00267	PIN BAR, HT-740T/KF-2.5T	1
UAJ20	402-00245	SCREW ST2.9*6.5, HT-740T/KF-2.5T	49	UAS35	406-00268	AXLE CAP, HT-740T/KF-2.5T	1
UAJ21	402-00246	SCREW ST4.2*12, HT-740T/KF-2.5T	20	UAD1	407-00142	CONSOLE, KF-2.5T	1
UAJ22	402-00247	SCREW ST2.9*15, HT-740T/KF-2.5T	4	UAD2	407-00133	BOARD, HEARTBEAT, HT-740T/KF-2.5T	1
UAJ23	402-00248	SCREW ST3.5*35, HT-740T/KF-2.5T	2	UAD3	407-00134	BOARD, QUICK ACCESS KEY, HT-740T/KF-2.5T	1
UAJ24	402-00249	SCREW ST4.2*12, HT-740T/KF-2.5T	6	UAD4	407-00135	PULSE SENSOR, HT-740T/KF-2.5T	2
UAJ25	402-00250	SCREW ST4.2*9.5, HT-740T/KF-2.5T	16	UAD5	402-00267	SAFETY KEY, HT-740T/KF-2.5T	1
UAJ26	402-00251	SCREW ST4.2*19, HT-740T/KF-2.5T	2	UAD6	413-00094	WIRE, AC SINGLE 6, HT-740T/KF-2.5T	1
UAJ27	402-00252	FLAT WASHER M10, HT-740T/KF-2.5T	15	UAD7	413-00095	WIRE, AC SINGLE 7, HT-740T/KF-2.5T	1
UAJ28	402-00253	FLAT WASHER M8, HT-740T/KF-2.5T	29	UAD8	413-00096	WIRE, AC SINGLE 8, HT-740T/KF-2.5T	1
UAJ29	402-00254	FLAT WASHER M5, HT-740T/KF-2.5T	4	UAD9	413-00097	WIRE, INCLINE MOTOR CONNECTION	1
UAJ30	402-00255	SPRING WASHER M8, HT-740T/KF-2.5T	6	UAD10	413-00098	UPPER, COMPUTER WIRE, HT-740T/KF-2.5T	1
UAJ31	402-00256	LOCK NUT M8, HT-740T/KF-2.5T	8	UAD11	413-00099	LOWER, COMPUTER WIRE, HT-740T/KF-2.5T	1
UAJ32	402-00257	LOCK NUT M10, HT-740T/KF-2.5T	1	UAD12	413-00100	MIDDLE, COMPUTER WIRE, HT-740T/KF-2.5T	1
UAJ33	402-00258	SCREW M4*6, HT-740T/KF-2.5T	4	UAD13	413-00101	ADAPTOR, HT-740T/KF-2.5T	1
UAJ33	402-00258	SCREW M4*6, HT-740T/KF-2.5T	4	UAD14	407-00136	CONTROL BOARD, HT-740T/KF-2.5T	1
UAJ34	402-00259	SCREW M4*10, HT-740T/KF-2.5T	1	UAD15	406-00269	OVERLOADING PROTECTOR, HT-740T/KF-2.5T	1
UAJ35	402-00260	SCREW M4*10, HT-740T/KF-2.5T	1	UAD16	408-00062	BREAKER, HT-740T/KF-2.5T	1
UAJ36	402-00261	BOLT M6*45, HT-740T/KF-2.5T	2	UAD17	413-00102	POWER CABLE, HT-740T/KF-2.5T	1
UAW1	402-00262	SLEEVE TUBE, HT-740T/KF-2.5T	4	UAD18	412-00033	DC MOTOR, 2.5HP HT-740T/KF-2.5T	1
U1W2	409-00019	FRONT ROLLER, HT-740T/KF-2.5T	1	UAD19	412-00034	INCLINE MOTOR, HT-740T/KF-2.5T	1
U1W3	409-00020	REAR ROLLER, HT-740T/KF-2.5T	1	UAD20	402-00268	MAGNETIC RING, HT-740T/KF-2.5T	1
U1W4	419-00040	AXLE, HT-740T/KF-2.5T	1	UAD21	413-00103	REED SWITCH, HT-740T/KF-2.5T	1
U1W5	419-00041	LIMIT AXLE, HT-740T/KF-2.5T	1	U1D22	403-00014	WALKING BOARD, HT-740T/KF-2.5T	1
UAW6	406-00239	SLEEVE, HT-740T/KF-2.5T	2	UAJ37	402-00269	LOCK NUT M6, HT-740T/KF-2.5T	8
U1W7	410-00068	GAS SHOCK, HT-740T/KF-2.5T	2	U1W12	406-00279	SPEAKER GRILL, LEFT, KF-2.5T	1
UAW8	402-00263	#6 ALLEN WRENCH, HT-740T/KF-2.5T	1	U1W13	406-00280	SPEAKER GRILL, RIGHT, KF-2.5T	1
UAW9	402-00264	#5 ALLEN WRENCH, HT-740T/KF-2.5T	1	U1D23	407-00139	SPEAKER, KF-2.5T	2
UAW10	402-00265	WRENCH W/SCREW DRIVER, HT-740T/KF-2.5T	1	U1D24	413-00104	TOP SPEAKER WIRE OF AMPLIFYING BOARD, KF-	1
UAW11	410-00069	COMPRESSING SPRING, HT-740T/KF-2.5T	1	U1D25	413-00105	MIDDLE SPEAKER WIRE OF AMPLIFYING BOARD,	1
UAD23	407-00138	SPEED INCLINE PCB, HT-720T, HT-740T/KF-2.5T	2	U1D26	413-00106	BOTTOM SPEAKER WIRE OF AMPLIFYING BOARD	1
UAS1	406-00240	PLASTIC FIXING BRACKET, HT-740T/KF-2.5T	1	U1D27	413-00107	MP3 CONNECT WIRE, KF-2.5T	1
UAS2	406-00241	END CAP, HT-740T/KF-2.5T	2	U1D28	413-00108	MP3 WIRE CONNECTER, KF-2.5T	1
UAS3	406-00242	MOTOR FAN, UAS3	1	U1D29	407-00140	AMPLIFYING BOARD, KF-2.5T	1
U1S4	404-00022	RUNNING BELT, KF2.5T	1	U1D30	413-00109	AMPLIFYING ADAPTOR, KF-2.5T	1
UAS5	406-00243	INSERT, HT-740T/KF-2.5T	1	U1D31	413-00110	AMPLIFYING WIRE, KF-2.5T	1
UAS6	406-00244	COVER, COMPUTER TOP, HT-740T/KF-2.5T	1	U1D32	413-00111	AMPLIFYING WIRE 1, KF-2.5T	1

Warranty Information



Residential and Personal Use Limited Warranty

PLEASE READ THESE WARRANTY TERMS AND CONDITIONS FULLY AND CAREFULLY BEFORE USING YOUR KEYS FITNESS EQUIPMENT. BY USING THE EQUIPMENT, YOU ARE CONSENTING TO BE BOUND BY THE FOLLOWING TERMS AND CONDITIONS.

Frame: Lifetime Drive Motor: Lifetime Parts: 2 yrs Deck and Belt: 5 Yrs Labor: 1 Yr Speakers: 1 Yr
Missing/Cosmetic Parts: 30 Days

Limited Warranty

This Limited Warranty applies in the United States and Canada to Products manufactured or distributed by Keys Fitness Products, L.P. under the Keys Fitness ("Keys") brand name (as used herein, the "Product" or "Products"). The warranty period to the original purchaser is listed above, and commences on the date of original purchase of the product, unless otherwise authorized by Keys. Keys warrants that the Product purchased from Keys or from an authorized Keys Fitness reseller "dealer" (for residential or personal use only, unless otherwise authorized by Keys in writing), is free from defects in Materials and Workmanship relevant to the functionality of the Product at *initial startup*, under normal use, and during the applicable warranty period, unless otherwise determined by Keys.

This warranty *excludes expendable parts* if the primary cause for a warranty claim is wear. *Expendable parts* pertain to components on the Product that are prone to normal wear and tear. These items vary by Product, and may include (but not be limited to) hand grips, skid pads, walking belts, walking decks, poly-v belts, console overlays, toggle switch/button overlays, (luster free or dull) ekg plates, decals, and any other items that are not essential to the operation of the Product, unless otherwise determined by Keys.

This warranty extends only to you, the original purchaser. It is not transferable to anyone who subsequently purchases (or receives as a gift) the Product from you. Your sales receipt, showing the date/place of purchase and serial number (if applicable) of the Product, is your proof of purchase, and may be required by Keys any time a warranty parts or service claim is made or if no warranty record exists for the product.

Exclusive Remedies

During the warranty period listed above, Keys will repair a Product by correcting any minor issues (either by phone or online support) that might be causing the Product failure. Should a technical service and support representative be unable to correct the issue, Keys may replace the parts (with new parts or at the option of Keys, with serviceable used parts, that are equivalent to new parts in performance) that become defective, malfunction, or otherwise fail to conform to this Limited Warranty under normal use.

Replacement parts shall be warranted for 30 days from the shipment reception date or through the end of the 'replaced' part warranty period, whichever is longer. Any replacement parts, required *past the warranty period* listed above, shall be subject to purchase at retail price, plus any added shipping and handling charges associated to the delivery of the part. Note that replacement parts may be available only through the ***lifetime* (as defined) of the Product. In conforming to this warranty, Keys (as the manufacturer) reserves the right to change manufacturers or vendors of any part to cover the existing warranty.

Keys may also provide service (if deemed necessary and if applicable) at no charge to you during (and not to exceed) the service warranty period listed above, in an attempt to repair the Product. Should the Product require service at your request or out of the limited warranty period, Keys can furnish contact information for local (to your area) Keys authorized service providers. Service quotes, costs, and scheduling will be strictly dependent on service provider rates and mutual (consumer/provider) service agreements. Keys is not responsible for any service repair costs accrued through the use of authorized Keys service providers dispatched at your request or out of the limited warranty period (without written consent from Keys), and beyond the limitations outlined on this warranty.

Replacements and Returns

If after a reasonable number of attempts, a defect has not been repaired (or the Product is deemed non-repairable by Keys technical service and support staff), Keys, based on a case by case review, may opt to replace the Product, or recommend an alternate resolution, such as a warranty buy-out (Product cost, subject to deduction of a reasonable charge for usage) or a credit.

Keys, as a manufacturer, reserves the right to replace the Product with a Factory-Reconditioned Product that meets or exceeds standards comparable to those of the replaced Product.

The warranty covering the replacement Product shall expire on the date the original warranty for the replaced Product would have expired, unless otherwise determined by Keys. Note that a *non-defective* Product may not be eligible for return or replacement after 30 days from date of purchase. If opting to return a non-defective product to Keys, as the manufacturer, within 30 days from date of purchase (in its original packaging and with its original proof of purchase), the "customer" shall be subject to a 15% restocking fee and pre-paid freight charges accrued as a result of the return, unless otherwise determined by Keys.

Conditions and Restrictions

This warranty **DOES NOT** (A) cover shipping and handling charges, export taxes, custom duties and taxes, or any other charges associated with transportation of the parts or Product, beyond the initial courtesy period of 60 days from original date of purchase of the Product; (B) extend to Products not purchased from Keys or from an authorized Keys reseller; (C) extend to Products purchased from online auction sites; (D) cover any extended, additional, or third party warranties if not offered exclusively by Keys in writing; (E) cover Products installed at fee based facilities/commercial environments (gyms, homes used as wellness centers, etc.); (F) cover Products installed in light institutional environments (non fee-based facilities with total Product use time not exceeding 5 hours daily, to include for example, and not be way of limitation, fire houses, police departments, rehab centers, hospitals, clinics, apartment complexes, club houses, etc.); (G) cover service calls to correct installation, perform maintenance, or instruct owners on how to use the equipment; or (H) cover a Product on which the serial number has been purposefully or accidentally defaced or removed and there is no proof of purchase available (if serial number is applicable), unless authorized by Keys in writing or otherwise stated on this warranty.

This Limited Warranty becomes void for Products that have been damaged or rendered defective as a result of (a) accident, misuse, or abuse (including but not limited to exceeding the Keys listed, maximum weight limit); (b) use of parts not manufactured or sold by Keys; (c) modification of the Product; (d) normal wear and tear; (e) operation on incorrect power supplies; (f) ****failure to perform* (or performing improper) maintenance; (g) service by anyone other than Keys, or an authorized Keys warranty service provider; (h) floods, fires, earthquakes, lightning strikes, power surges, and other unavoidable acts of nature; (j) residential mis-wires; or (k) incorrect setup, installation, or assembly. Should any Product (submitted for warranty parts replacement) be found ineligible under the terms outlined on this warranty, an estimate for parts purchase (if available) can be furnished at your request.

***Parts** is herein defined exclusively, for all intents and purposes, and pertaining to this Limited Manufacturer Warranty, as components or Materials essential to the functionality of the Product.

****Lifetime** of a Product, is herein defined exclusively, for all intents and purposes, and pertaining to this Limited Manufacturer Warranty, as the time period 7 years beyond the end of production cycle of a Product in question.

******* Includes proper lubrication of the running deck and walk belt area, as indicated in the owner's manual.

Disclaimer and Release

EXCEPT AS EXPRESSLY SET FORTH IN THIS WARRANTY, KEYS MAKES NO OTHER WARRANTIES, EXPRESSED OR IMPLIED, INCLUDING ANY IMPLIED WARRANTIES OF MERCHANTABILITY AND FITNESS FOR A PARTICULAR PURPOSE. KEYS EXPRESSLY DISCLAIMS ALL WARRANTIES NOT STATED IN THIS LIMITED WARRANTY. ANY IMPLIED WARRANTIES THAT MAY BE IMPOSED BY LAW ARE LIMITED TO THE TERMS OF THIS LIMITED WARRANTY. NEITHER KEYS NOR ANY OF ITS AFFILIATES SHALL BE RESPONSIBLE FOR INCIDENTAL OR CONSEQUENTIAL DAMAGES. SOME STATES DO NOT ALLOW LIMITATIONS ON IMPLIED WARRANTIES OR THE EXCLUSION OR LIMITATION OF INCIDENTAL OR CONSEQUENTIAL DAMAGES, SO THE ABOVE LIMITATIONS OR EXCLUSIONS MAY NOT APPLY TO YOU. THIS LIMITED WARRANTY GIVES YOU SPECIFIC LEGAL RIGHTS AND YOU MAY ALSO HAVE OTHER RIGHTS THAT MAY VARY FROM STATE TO STATE. THIS IS THE ONLY EXPRESS WARRANTY APPLICABLE TO KEYS-BRANDED PRODUCTS. KEYS NEITHER ASSUMES NOR AUTHORIZES ANYONE TO ASSUME FOR IT ANY OTHER EXPRESS WARRANTY.



Customer Service
(888) 340-0482

Keys Fitness Products
4009 Distribution Drive
Suite 250
Garland, TX 75041

www.keysfitness.com

Free Manuals Download Website

<http://myh66.com>

<http://usermanuals.us>

<http://www.somanuals.com>

<http://www.4manuals.cc>

<http://www.manual-lib.com>

<http://www.404manual.com>

<http://www.luxmanual.com>

<http://aubethermostatmanual.com>

Golf course search by state

<http://golfingnear.com>

Email search by domain

<http://emailbydomain.com>

Auto manuals search

<http://auto.somanuals.com>

TV manuals search

<http://tv.somanuals.com>