

KINGSTON TECHNOLOGY
FAST ETHERX STACKABLE
8-PORT, 16-PORT, & 24-PORT
10/100TX RACK-MOUNTABLE
DUAL SPEED HUB
USER'S GUIDE

MODELS: KND810TX
KND1610TX
KND2410TX

Kingston Technology

Fast EtheRx Stackable
8-Port, 16-Port, & 24-Port
10/100TX Rack-Mountable
Dual Speed Hubs

User's Guide

Part No. 4460064-001.A01



Kingston Technology Company
17600 Newhope
Fountain Valley, CA 92708
(714) 435-2600

Important Safety Instructions

KND2410TX User's Guide - Rev. A01

Kingston Technology Company

-
1. Read all these instructions.
 2. Save these instructions for later use.
 3. Follow all warnings and instructions marked on the product.
 4. Do not use this product near water.
 5. This product should be operated from the type of power source indicated on the marking label. If you are not sure of the type of power available, consult your dealer or local power company.
 6. Do not attempt to service this product yourself, as opening or removing covers may expose you to dangerous voltage points or other risk. Refer all servicing to service personnel.

Wichtige Sicherheitshinweise

1. Diese Hinweise sollten vollständig durchgelesen werden.
2. Diese Hinweise für einen späteren Gebrauch aufbewahren.
3. Allen auf dem Gerät angebrachten Warnungen und Hinweisen folgen.
4. Das Gerät nicht in der Nähe von Wasser verwenden.
5. Das Gerät nur mit dem Aufkleber bezeichneten Netzspannung betreiben. Bei Fragen über die Art der Netzspannung sollte der Händler oder das Energieversorgungsunternehmen zu rate gezogen werden.
6. Nicht versuchen das Produkt selbst zu reparieren. In allen Produkten existieren gefährliche elektrische Spannungen. Nicht das Gehäuse öffnen.

Table Of Contents

Introduction.....	1
Model Types.....	1
Special Features	2
Package Contents	2
Design Features	3
Repeater Functions	3
Receive Jabber Protection	3
Collision-Handling	3
Error-Handling	3
Automatic Port Partitioning / Reconnection	3
Hardware Installation	4
Front Panel.....	4
Power LED	4
Collision LEDs.....	4
100TX (Speed-Detection) LEDs.....	4
Link / Activity LEDs	4
10/100TX UTP Ports.....	5
Uplink Port	5
Rear Panel	6
Power Switch	6
AC Power Connector	6
Fuse.....	6
Fan Unit(s)	6
Stack-In / Stack-Out Ports	7
Speed-Setting Dip Switches.....	8
Appendices.....	9
Appendix A Pin Assignments	10
UTP Port Pin Assignments.....	10
Appendix B Cabling Guidelines	11

UTP Cable Type	11
UTP Cable Wiring	11
UTP Cable Wiring Standards	11
UTP Cable Rating Codes	12
Appendix C Specifications	13
Appendix D Commonly Asked Questions	15
Appendix E Warranties and Notices	16
Limited Warranty Statement	17
Duration of Warranty	17
Free Technical Support	18
Disclaimers	18
F.C.C. Certification	19
CE Notice	19

Introduction

Intended Audience: This manual assumes that the user has a general working knowledge of networking principles and is familiar with network systems in general.

Congratulations on the purchase of your Kingston Fast EtherX Stackable 10/100TX Rack-Mountable Dual Speed hub. There are three models available: **KND810TX** (8-port model), **KND1610TX** (16-port model) **KND2410TX** (24-port model). The KND810TX and KND1610TX can be used on a desktop or standard 19" rack-mount installation, using the extended mounting brackets provided with the unit. The KND2410TX is a full 19" rack-mount unit. The Fast EtherX Stackable 10/100TX Dual-Speed hubs conform to IEEE802.3u 100BASE-TX, IEEE802.3i 10BASE-T, and IEEE802.3 CSMA/CD standards. Using any combination of the dual-speed hubs, you can stack up to a maximum of four hubs.

For ease of installation, the Fast EtherX Stackable Dual Speed hubs offer eight (8), sixteen (16), or twenty-four (24) UTP ports that auto-negotiate 10/100Mbps operation and an uplink port that allows the last UTP port on the hub to support both crossover and straight-through cabling. By default port 7 & 8 (KND810TX & KND1610TX) or port 23 & 24 (KND2410TX) are set for auto-negotiation but can be manually configured for either 10Mbps or 100Mbps operation, using the dip switches located on the back of the unit. Ideal for inter-connecting 10BASE-T Ethernet networks with 100BASE-TX Fast Ethernet networks, the Fast EtherX Dual-speed hubs can also be used as simple stand-alone 10BASE-T or 100BASE-TX repeaters. For easy trouble-shooting, the front panel includes a variety of diagnostic LEDs such as Power, Collision for 10Mbps and 100Mbps, 100TX, Link, and Activity status.

For the remainder of this manual, the Fast EtherX Stackable 10/100TX Dual-Speed hubs will be referred to collectively as the Fast EtherX Dual-Speed hubs:

KND810TX - Fast EtherX Stackable 8-port Rack-mountable dual-speed hub

KND1610TX - Fast EtherX Stackable 16-port Rack-mountable dual-speed hub

KND2410TX - Fast EtherX Stackable 24-port Rack-mountable dual-speed hub

Model Types

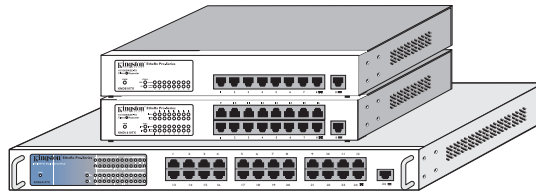

Fig. 1-1 – KND810TX, KND1610TX, & KND2410TX

Special Features

- Conforms to IEEE802.3u 100BASE-TX, IEEE802.3i 10BASE-T, and IEEE802.3 CSMA/CD standards
- Inter-connects 10BASE-T Ethernet networks with 100BASE-TX Fast Ethernet networks
- Works as a simple 100BASE-TX or 10BASE-T repeater
- 10/100BASE-TX Class **II** compliant repeater
- Stacking ports for stacking up to four (4) hubs maximum
- 8, 16, or 24 UTP ports that auto-negotiate 10/100TX operation
- Dip switches to manually configure the speed setting on ports 7 & 8 (or ports 23 & 24) for 10Mbps, 100Mbps, or auto-negotiation (default)
- 8, 16, or 24 100TX LEDs for 100Mbps speed detection
- 8, 16, or 24 Link / Activity status LEDs for easy troubleshooting
- Individual collision LEDs for both 10Mbps and 100Mbps collision detection
- 1 Power LED for power status
- Automatic port partitioning / reconnection
- Uplink port that supports both crossover and straight-through cable wiring
- Internal auto-sensing power supply operating at 100-240VAC (50/60Hz)
- Desktop or rack-mountable

Package Contents

The Fast EtherX Dual-Speed package should contain the following items:

- Fast EtherX **KND810TX**, **KND1610TX**, or **KND2410TX** dual-speed hub
- 50-pin shielded stacking cable
- AC power cord
- Mounting kit includes:
 - (2) Angle brackets
 - (8) Mounting Bracket screws
 - (4) 10/32" Rack-Mount thumb screws
 - (4) Rubber feet
- User's Guide

If any of the items are missing or damaged, please contact your Kingston dealer for a replacement. Be sure the items you receive are genuine Kingston Technology products. If the Kingston name and logo are not on the front panel of the unit, it's not a genuine Kingston product.

Design Features

The Fast EtherX dual-speed hub complies with the full set of repeater basic functions as defined by IEEE802.3u 100BASE-TX, IEEE802.3i 10BASE-T, and IEEE802.3 CSMA/CD standards.

Repeater Functions

If any single port senses the start of a valid packet on its receiving line, the dual-speed hub will re-transmit the received data to all other ports on the network. The re-transmission of packets complies with the IEEE 802.3 specification in terms of preamble structure, voltage amplitude, and timing characteristics.

Auto-Negotiation

Auto-Negotiation provides the means of automatically establishing a link by detecting the link capabilities of the connected device on the network to select the best operational mode available (i.e. 10/100Mbps selection)

Receive Jabber Protection

The dual-speed hub uses a Receive Jabber Protection scheme to ensure that the network is not disabled due to reception of excessively long data packets.

Collision-Handling

The dual-speed hub will detect and respond to collision conditions as outlined in the IEEE 802.3 specifications.

Error-Handling

With 100BASE-TX Fast Ethernet, the new error-handling feature prevents sub-standard links from generating streams of false carrier and interfering with other links.

Automatic Port Partitioning / Reconnection

If any of the ports on the dual-speed hub experience excessive collisions, or faulty conditions, that particular port can be partitioned. Once partitioned, the hub will continue to monitor that port. If the error conditions have been corrected or a good data packet is received or transmitted without a collision, the hub will automatically reconnect that port to the network.

Hardware Installation

Before you begin installing network cables, please take a few minutes to familiarize yourself with the dual-speed hub. See the diagram below:

Front Panel

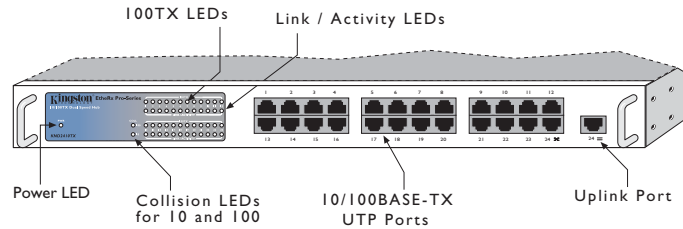

Fig. 1-2 KND2410TX Front Panel

Power LED

The green LED indicates the power status. The LED will light up when the AC power connector is properly connected to a power source.

Collision LEDs

There are two (2) separate collision LEDs for both 10Mbps and 100Mbps segments. If a collision is detected on a 10Mbps segment, the “10” LED will flash amber. If a collision is detected on a 100Mbps segment, the “100” LED will flash amber. Collisions occur when 2 or more ports receive data simultaneously.

100TX (Speed-Detection) LEDs

The 100TX LED lights up when 100Mbps operation is detected. The 100TX LED will not light up if 10Mbps operation is detected.

Link / Activity LEDs

The LINK / ACTIVITY LEDs service both 10BASE-T and 100BASE-TX operation. A steady green light indicates that a good link has been established. A flashing green light indicates that data is being received.

If the Link LED does not display a steady green link light, please check the following:

1. Make sure the power is turned on for both the PC and EtheRx hub.
2. Verify that the correct network drivers have been loaded on the PC. Some network adapters require the drivers to be loaded to establish a proper link.
3. Make sure the correct cable type is selected.
4. Make sure the cable is wired properly and connected on both ends.
5. If steps 1 through 4 are correct, the cable may be defective or not wired correctly. Please refer to Appendix A for pin assignments and Appendix B for cabling guidelines.

10/100TX UTP Ports



The eight (8), sixteen (16), and twenty-four (24) 10/100TX UTP ports auto-negotiate both 10BASE-T and 100BASE-TX connections. The speed settings for ports 7 & 8 (on the KND810TX & KND1610TX models) and ports 23 & 24 (on the KND2410TX model) can also be manually configured to operate at 10Mbps or 100Mbps using the dip switches located on the back of the unit (see **Speed-Setting Dip Switches** in the Rear Panel section). All ports like all normal hub ports are configured as MDI-X. However, port 8 (models KND810TX and KND1610TX) & Port 24 (model KND2410TX), support both MDI-X and MDI port configuration.

Uplink Port

The uplink port provides cabling flexibility on UTP port no. 8 (KND810TX & KND 1610TX models) and UTP port 24 (2410TX model) for connecting to a workstation NIC or cascading to another hub. Although these ports have two (2) UTP connections, MDI and MDI-X, only one port may be used.

Notes on MDI and MDI-X Ports

MDI (Media Dependent Interface) is the standard that defines the mechanical and electrical configuration of a UTP port. For any two devices to communicate with each other, the transmitter of one device must be connected to the receiver of the other device.

Switch Position	Port Config	For Connection to another Hub Port (MDI-X)	For Connection to a Network Adapter (MDI)
	MDI-X	Use Crossover cable	Use Straight-through cable
	MDI	Use Straight-through cable	Use Crossover cable

Rear Panel

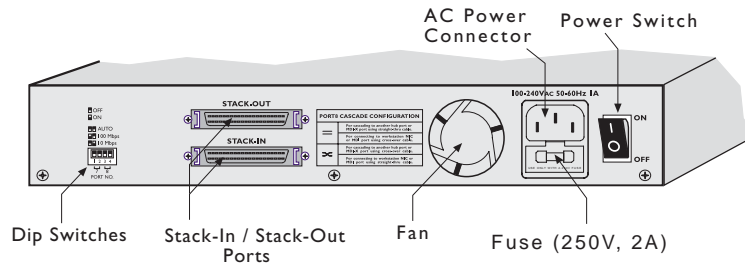

Fig. 1-3 Rear Panel

Power Switch

The AC Power switch turns the unit ON or OFF. If the PWR LED does not light up once the unit has been turned on, try the procedures below (in the following order):

1. Try a different AC power outlet.
2. Check the external fuse located at the back of unit (below the AC power connector). If the fuse is blown, replace it with the spare fuse provided with the unit. (See *Fuse Compartment* display on page 8)
3. The power supply may be defective. Return the unit for replacement.

WARNING: For safety reasons, **DO NOT** attempt to open and service the unit. There are no user-serviceable components inside.

AC Power Connector

The Fast EtherX dual-speed hubs use 100-240VAC internal power supplies. Connect the AC power cord from the back of the unit to an AC electrical outlet.

Fuse

The Fast EtherX dual-speed hubs come equipped with one external fuse and one spare fuse. Both fuses are in a fuse holder located just below the AC power connector on the back of the unit. Both fuses are rated 250V/2A max.

Fan Unit(s)

The Fast EtherX dual-speed hubs use independent cooling fans for optimum air-flow to safeguard the unit from unnecessary heat exposure.

Stack-In / Stack-Out Ports

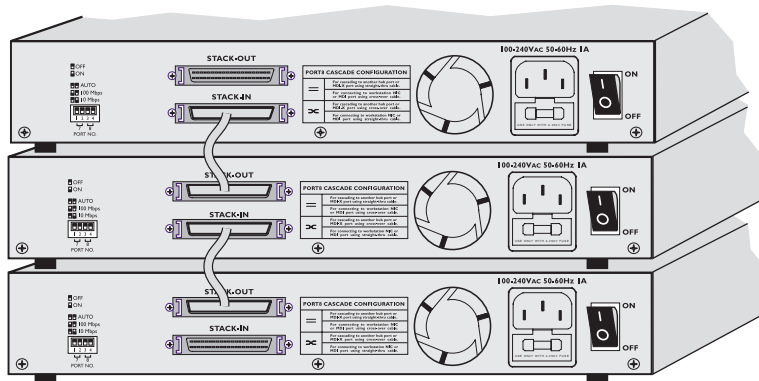

Fig. 1-4 Stacking Configuration

The Fast EtherX stackable hubs use stacking ports located on the back of the unit to stack up to a maximum of four hubs, using any combination of the KND810TX, KND1610TX, and KND2410TX models. Follow the directions below on stacking these hubs together:

1. Power down the Fast EtherX hub(s).
2. Locate the 50-pin shielded stacking cable included with your package contents.
3. Plug one end of the cable into the port labeled, **“Stack-Out”** on the first hub.
4. Plug the other end of the cable into the **“Stack-In”** port on the second hub.
5. Repeat steps 2 through 4 for stacking up to a maximum of four (4) hubs.

Kingston’s *Stack-n-Play*[™] feature offers greater scalability to add UTP ports without the need to configure ID or termination switches. When configured as a stack, the Fast EtherX stackable hubs are recognized as a single unit on the network. By stacking hubs together, you can expand the total number of UTP ports up to 96 ports.

Speed-Setting Dip Switches

The dip switches located on the back of the unit can be used to manually configure ports 7 & 8 (KND810TX & KND1610TX) or port 23 & 24 (KND2410TX) to operate at 10Mbps, 100Mbps, or Auto-negotiation (default). Dip switches in the 'UP' position are set to **OFF** (default). Dip switches in the 'DOWN' position are set to **ON**. For specific speed setting combinations, see Table 1-2 below.

DIP SWITCH SETTINGS	PORT NO. 7 (or 23)		PORT NO. 8 (or 24)		EXAMPLE
	DIP SWITCH 1	DIP SWITCH 2	DIP SWITCH 3	DIP SWITCH 4	
AUTO-NEGOTIATION	UP = OFF	UP = OFF	UP = OFF	UP = OFF	
100MBPS	DOWN = ON	UP = OFF	DOWN = ON	UP = OFF	
10MBPS	UP = OFF	DOWN = ON	UP = OFF	DOWN = ON	

Table 1-2 Dip Switch Settings

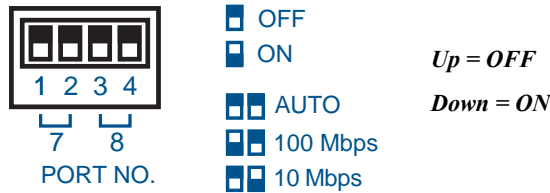

*Fig. 1-5 Dip Switch Configuration
(KND810TX & KND1610TX)*

(NOTE: The Fast EtherX stackable hubs come equipped with one external fuse and one spare fuse. Both fuses are in a fuse holder located just below the AC power connector on the back of the unit. Both fuses are rated 250V/2A maximum.)

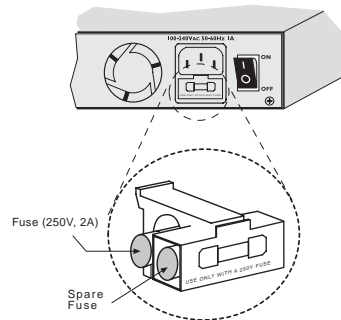

Fig. 1-6 Fuse(s) Compartment

Appendices

Appendix A Pin Assignments

UTP Port Pin Assignments

UTP Ports use RJ-45 Unshielded Twisted Pair (UTP) cabling. RJ-45 modular plugs and their pin numbers and wiring assignments are listed below. Twisted-Pair cables can be wired with either Straight-Through or Crossover pin assignments. Both wiring schemes are mentioned in "Appendix B Cabling Guidelines" for reference in creating a twisted-pair cable.

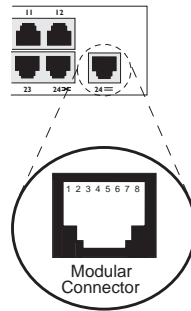

Fig. A-1 RJ-45 Connector Pin Numbers

Pin Number	MDI-X / ∞	MDI / ≡
1	Receive Data +	Transmit Data +
2	Receive Data -	Transmit Data -
3	Transmit Data +	Receive Data +
4,5	Not Used	Not Used
6	Transmit Data -	Receive Data -
7,8	Not Used	Not Used

Table A-1 UTP Pin Assignments

(NOTE: For further details, refer to **Notes on MDI & MDI-X** on page 5)

Appendix B Cabling Guidelines

UTP Cable Type

When installing network cables, the following table shows appropriate cabling guidelines for 100BASE-TX Fast Ethernet architecture.

Cabling Components:	100BASE-TX
Trunk and Patch Cable Type:	4-Pair 100Ω UTP CAT 5 (only 2 pairs used)
Modular Plug:	8-Pin RJ-45 CAT 5 only
Patch Panel:	8-Pin RJ-45 CAT 5 only

Table B-1 Network Cable Guidelines

(NOTE: All UTP cables come in both solid and stranded filament. Solid filament cables are more rigid and usually intended for trunk cabling. Stranded filament cables are more pliable and generally targeted for patch cables. For proper termination, use the correct RJ-45 connector, as they differ for each type of cable.)

UTP Cable Wiring

UTP cables are wired based on one of two standard pin configurations: **Straight-Through** and **Cross-Over**. 100BASE-TX uses only Category-5 UTP cables with four pairs of wire as illustrated below in Tables B-2 and B-3.

"Straight-Through" Configuration

Pin Number	Pin Number
1 (TRX+)	1 (TRX+)
2 (TRX-)	2 (TRX-)
3 (RCV+)	3 (RCV+)
6 (RCV-)	6 (RCV-)
4, 5, 7, 8	Not Used

Table B-2. Straight-Through Wiring

"Cross-Over" Configuration

Pin Number	Pin Number
1 (TRX+)	3 (RCV+)
2 (TRX-)	6 (RCV-)
3 (RCV+)	1 (TRX+)
6 (RCV-)	2 (TRX-)
4, 5, 7, 8	Not Used

Table B-3. Cross-Over Wiring

UTP Cable Wiring Standards

There are two governmental agencies: the Electronic Industry Association (EIA) and the Telecommunications Industry Association (TIA), which set the standard for all cable wiring requirements for commercial buildings.

With the advent of 100Mb/s networking products, it is best to use higher quality CAT 5 cables like Belden or Helix as well as CAT 5-compliant patch panels, patch cables, and connectors while following the EIA/TIA wiring standards. 100 Ω UTP CAT 5 type cables use 4-pair UTP wiring.

Refer to the illustrations below for 4-pair wiring using either T568A (Fig. B-1) or T568B (Fig. B-2) wiring standards. Both T568A and T568B wiring is compatible with 10BASE-T and 100BASE-TX and require no special configurations, but for premise wiring, stick to one wiring standard. Mixing T568A and T568B wiring schemes may cause or lead to potential problems.



Fig. B-1 4-Pair T568A Wiring

T568A	Pairs	Strand	Solid
Pin 1	Pair 3	Blue	White/Green
Pin 2	Pair 3	Orange	Green/White
Pin 3	Pair 2	Black	White/Orange
Pin 4	Pair 1	Red	Blue/White
Pin 5	Pair 1	Green	White/Blue
Pin 6	Pair 2	Yellow	Orange/White
Pin 7	Pair 4	Brown	White/Brown
Pin 8	Pair 4	White	Brown/White

Table B-4 4-Pair T568A Wiring

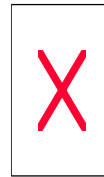

Fig. B-2 4-Pair T568B Wiring

T568B	Pairs	Strand	Solid
Pin 1	Pair 2	Black	White/Orange
Pin 2	Pair 2	Yellow	Orange/White
Pin 3	Pair 3	Blue	White/Green
Pin 4	Pair 1	Red	Blue/White
Pin 5	Pair 1	Green	White/Blue
Pin 6	Pair 3	Orange	Green/White
Pin 7	Pair 4	Brown	White/Brown
Pin 8	Pair 4	White	Brown/White

Table B-5 4-Pair T568B Wiring

UTP Cable Rating Codes

UTP cables meet different UL-NEC requirements based on cable-jacket quality. Below is an explanation of the rating codes for each cable type.

UL – The National Electrical Code (NEC), published by the National Fire Protection Association (NFPA), details advisory safety considerations for electrical wiring. NEC Article 800 Communications Cables are manufactured to meet these different cable types.

1. **CMP** – Cables meeting type CMP requirements are suitable for installation in ducts and plenums without the use of conduit. These cables are designed for fire resistance and low-smoke producing characteristics.
2. **CMR** – Riser type cables are engineered to prevent the spread of fire from floor to floor and are suitable for vertical shaft applications.
3. **CM** – Cables for general building wiring. CM cables are used in areas other than plenums and risers. These cables are resistant to the spread of fire and pass the UL 1581 Vertical Tray Flame Test.
4. **MP, MPR & MPP** – Within Article 800, the Multi-purpose Cables Category allows conditional substitutions between different cable types & are restricted by number, AWG size and stranding of the cable conductors.

Terms You Should Be Familiar With

1. **BACKBONE WIRING** – The physical/electrical interconnections between telecommunications closets and equipment rooms.
2. **COMPLIANCE** – A wiring device that meets all characteristics of a standard is said to be in compliance with that standard.
3. **PREMISE WIRING** – The entire wiring system on the premises especially the supporting wiring that connects the communications outlets to the network interface jack.
4. **NEAR-END CROSSTALK (NEXT)** – In wires packed together within a cable, the signals generated at one end of the link can flush out the weaker signals coming back from the recipient.

Appendix C Specifications

Fast EtherX KND810TX, KND1610TX, KN J2410TX

Compliance:	IEEE802.3u 100BASE-TX Standard IEEE802.3i 10BASE-T Standard IEEE802.3 CSMA/CD Standard		
Media Interface: KND810TX KND1610TX KND2410TX	8 auto-negotiating 10/100TX UTP ports 16 auto-negotiating 10/100TX UTP ports 24 auto-negotiating 10/100TX UTP ports		
Speed Setting Dip Switches: [Used to manually configure the corresponding ports for 10Mbps, 100Mbps, or Auto-negotiation (default setting)].	KND810TX	KND1610TX	KND2410TX
	Ports 7 & 8	Ports 7 & 8	Ports 23 & 24
Diagnostic LEDs:	1 LED for Power Indicator (steady green) 2 LEDs for both 10Mbps and 100Mbps collision detection (flashing amber) 8, 16, or 24 LEDs for 100TX speed detection (steady green) 8, 16, or 24 LEDs for Link (steady green) / Activity (flashing green)		
Stacking Cable:	50-pin shielded cable		
Additional stacking:	Up to a maximum of four (4) hubs		
Uplink port:	KND810TX	KND1610TX	KND2410TX
	Port 8	Port 8	Port 24
Connection Type:	RJ-45, Female		
Cable Type:	UTP 26 to 22 AWG		
Cable Grade: 10BASE-T 100BASE-TX	CAT3, 4, 5 or better CAT5 or better		
Max. Cable Length: Repeater to node Inter-repeater link 2 Class (II) Repeaters	100m (328ft)		
	5m (16.4ft)		
Environmental:			
Operating Temp.	0°C to 45°C (32°F to 113°F)		
Storage Temp.	-20°C to 60°C (-4°F to 140°F)		
Relative Humidity	10% to 90% non-condensing		
Electrical:			
Input Voltage:	100VAC-240VAC, 50/60Hz, auto-sensing internal power supply		
Output DC Voltage: KND810TX / KND1610TX: KND2410TX:	5 Vdc / 6A		
	5 Vdc / 11A		
Power Consumption:	KND810TX	KND1610TX	KND2410TX
	11.05 Watts max.	19.40 Watts max.	30.00 Watts max.
External Fuse:	250V / 2A maximum		
Physical:			
Dimension (HxWxD): KND810TX / KND1610TX: KND2410TX:	1.70" x 10.45" x 6.3" (43.2mm x 265.5mm x 160mm)		
	1.70" x 17.32" x 7.88" (43.2mm x 440.4mm x 200mm)		
Weight:	KND810TX	KND1610TX	KND2410TX
	3.4 lbs. (1.55 kg)	3.8 lbs. (1.73 kg)	6.2 lbs. (2.81 kg)
Certification:			
EMI Standards:	FCC Class A, CE CISPR A, C-Tick		
EMC Standards:	EN55022, IEC801-2, IEC801-3, IEC801-4		
Low Voltage Directive:	EN60950		
Safety Standards:	UL, cUL, TUV		

Appendix D Commonly Asked Questions

Class ① vs. Class ② 100BASE-TX Fast Ethernet Repeaters

There are currently two classes of Fast Ethernet repeaters, defined as Class ① and Class ②.

Class ①: in a maximum length segment topology, only **one** Class ① repeater may exist between any two nodes within a single collision domain.

Class ②: in a maximum length segment topology, **two** Class ② repeaters may exist between any two nodes within a single collision domain.

Will 100BASE-TX run on Category 3 cable?

No! Category 3 (CAT 3) cabling even in short lengths generates too much near end crosstalk for 100BASE-TX networks. The IEEE 802.3u 100BASE-TX Fast Ethernet standard requires Category 5 100 Ω UTP or 100 Ω STP which complies with ISO/IEC 11801:1995.

What is Category 5?

Category 5 (CAT 5) is a further extension of the EIA/TIA-568 cabling system to 100 MHz. Category 5 components (i.e., UTP trunk and patch cables, modular plug, and patch panel, etc.) are defined by EIA/TIA-568, but with the characterizations extended to 100 MHz by TSB-36 and TSB-40. The cable grades are categorized as follows:

- **Category 3:** up to 16 MHz
- **Category 4:** up to 20 MHz.
- **Category 5:** up to 100 MHz.

Category 5 Compliance vs. Category 5 Performance?

Having CAT 5 components in your network installation does not necessarily achieve full Category 5 performance. To achieve any category-rated performance, make sure all cabling components are at least of the minimum category required.

To achieve full CAT 5 performance, all components must be CAT 5 compliant and terminated properly according to EIA/TIA-568 TSB-36 and TSB-40 guidelines.

What are the Guidelines for Proper Termination?

It is important to maintain the twists of the cable as close to the termination on the outlet as possible, to avoid NEXT (Near End Cross Talk) and to maintain the transmissions characteristics of the Category. Category specifications require that pair twisting be maintained to within the following distances from the outlet termination:

- **Category 3 maximum allowed untwisting:** 3 inches
- **Category 4 maximum allowed untwisting:** 1 inch
- **Category 5 maximum allowed untwisting:** 1/2 inch

Can I mix CAT 3 and CAT 5 cabling in the same building?

Yes, but keep in mind, you will not have CAT 5 performance. It is a good idea to keep the lines separated when installing any new lines. Use CAT 5 UTP cabling only.

Can a Four-Pair CAT 5 cable support two 100BASE-TX devices?

Although only two pairs are used in the standard four-pair CAT 5 UTP cable, it is not recommended because it exceeds the specifications outlined by IEEE 802.3u.

Appendix E Warranties and Notices

Limited Warranty Statement

KINGSTON TECHNOLOGY COMPANY ("Kingston") warrants that this product is free from defects in material and workmanship. Subject to the conditions and limitations set forth below, Kingston will, at its option, either repair or replace any part of this product which proves defective by reason of improper workmanship or materials. Repair parts or replacement products will be provided by Kingston on an exchange basis, and will either be new or refurbished to be functionally equivalent to new.

Duration of Warranty

Lifetime Warranty: The following Kingston products are covered by this warranty for life: solid state memory (e.g., memory modules and boards), networking adapters, networking hubs without cooling fans (excluding the power supply), solid state PC Card (PCMCIA) adapters, and microprocessor upgrade products.

Seven Year Warranty: The following Kingston products are covered by this warranty for a period of seven years from the date of original retail purchase: storage enclosures (including the power supply), cables, terminators, and accessories.

Five Year Warranty: The following Kingston products are covered by this warranty for a period of five years from the date of original retail purchase: the power supply in networking hubs without cooling fans; and all other Kingston products (other than those products covered by a three-year, two-year, or one-year warranty, as provided below).

Three Year Warranty: The following Kingston products are covered by this warranty for a period of three years from the date of original retail purchase: networking hubs with cooling fans (including the power supply).

Two Year Warranty: The following Kingston products are covered by this warranty for a period of two years from the date of original retail purchase: Solid State Floppy Disk Cards (SSFDC), and Winchester hard disk drives in a 2.5 inch, 3.5 inch or 5.25 inch form factor.

One Year Warranty: The following Kingston products are covered by this warranty for a period of one year from the date of original retail purchase: Winchester hard disk drives in a 1.8 inch form factor, optical storage products, and magnetic tape storage products.

Warranty Claim Requirements

To obtain warranty service, return the defective product, freight prepaid and insured, to your local authorized Kingston dealer or distributor, or to the Kingston factory service center located at 17600 Newhope Street, Fountain Valley, California 92708, U.S.A. You must include the product serial number (if applicable) and a detailed description of the problem you are experiencing. You must also include proof of the date of original retail purchase as evidence that the product is within the applicable warranty period. If you return the product directly to the Kingston factory, you must first obtain a Return Material Authorization ("RMA") number by calling Kingston Customer Service at (714) 438-1810, and include the RMA number prominently displayed on the outside of your package. Products must be properly packaged to prevent damage in transit.

Free Technical Support

Kingston provides free technical support. If you experience any difficulty during the installation or subsequent use of a Kingston product, please contact Kingston's Technical Support department prior to servicing your system.

Kingston Technical Support can be reached in the U.S. at (714) 435-2639 or toll-free at (800) 435-0640 (U.S. and Canada only). Kingston European Technical Support can be reached from within the U.K. at 01932 738858. Kingston provides other service numbers when calling from Germany 0130 115 639 or fax 0130 860 599, from Austria 0660 5569 or fax 06 607 434, from Switzerland 0800 557 748 or fax 0800 552 182, from France 0800 905 701 or fax 0800 900 910, or from Belgium (in English) 0800 72763.

This warranty covers only repair or replacement of defective Kingston products, as provided above. Kingston is not liable for, and does not cover under warranty, any costs associated with servicing and/or the installation of Kingston products.

Disclaimers

The foregoing is the complete warranty for Kingston products and supersedes all other warranties and representations, whether oral or written. Except as expressly set forth above, no other warranties are made with respect to Kingston products and Kingston expressly disclaims all warranties not stated herein, including, to the extent permitted by applicable law, any implied warranty of merchantability or fitness for a particular purpose. In no event will Kingston be liable to the purchaser, or to any user of the Kingston product, for any damages, expenses, lost revenues, lost savings, lost profits, or any other incidental or consequential damages arising from the purchase, use or inability to use the Kingston product, even if Kingston has been advised of the possibility of such damages.

Copyright © 1997 Kingston Technology Company. All rights reserved. Printed in Taiwan. Kingston Technology and the Kingston logo are trademarks of Kingston Technology Company.

F.C.C. Certification

This device has been tested and found to comply with limits for Class A digital device, pursuant to Part 15 of the FCC Rules. Operation is subject to the following two conditions:

- (1) This device may not cause harmful interference, and
- (2) This device must accept any interference received; including interference that may cause undesired operation.

CE Notice

The official CE symbol indicates compliance of this Kingston Technology product to the EMC directive of the European Community. The CE symbol indicates that this Kingston product meets or exceeds the following standards:

- EN50081-1** “Electromagnetic Compatibility-generic emissions standard”
EN55022: “Limits and methods of measurement of radio interference characteristics.”
- EN50082-1** “Electromagnetic Compatibility-generic immunity standard”
IEC 801-2: “Electrostatic discharge requirements”
IEC 801-3: “Radiated immunity requirements”
IEC 801-4: “Electrical fast transient requirements”
- EN60950** “Low Voltage Directive (LVD)”
- Declaration of CE Conformity** in accordance with the above standards has been made and is on file at Kingston Technology.



C-Tick Certification

- AS/NZS 3548** “Information Technology Equipment”
- Declaration of C-Tick Conformity** in accordance with the above standards has been made and is on file at Kingston Technology.



N1298

Free Manuals Download Website

<http://myh66.com>

<http://usermanuals.us>

<http://www.somanuals.com>

<http://www.4manuals.cc>

<http://www.manual-lib.com>

<http://www.404manual.com>

<http://www.luxmanual.com>

<http://aubethermostatmanual.com>

Golf course search by state

<http://golfingnear.com>

Email search by domain

<http://emailbydomain.com>

Auto manuals search

<http://auto.somanuals.com>

TV manuals search

<http://tv.somanuals.com>