



KitchenAid™

**EXTRA CAPACITY
DRYERS**

**ELECTRIC MODEL
KEYE900S**

**GAS MODEL
KGYE900S**

USE & CARE GUIDE

CONTENTS

	Page
BEFORE USING YOUR DRYER	2
SAFETY FIRST	2
PARTS AND FEATURES	3
SETTING SELECTIONS AND STARTING YOUR DRYER	4
1. Touch "ON"	4
2. Touch a CYCLE Selection .	4
3. Touch a CUSTOM DRY or TIME Selection	5
OPTIONS	6
FEATURES	7
DRYING TIPS	9
LINT SCREEN	10
LINT REMOVAL	11
CARING FOR YOUR DRYER .	11
IF YOU NEED SERVICE OR ASSISTANCE	14
KITCHENAID™ WARRANTY .	16

BEFORE USING YOUR DRYER

Read this "USE & CARE GUIDE" and your "DRYER GUIDE" carefully for important use and safety information.

You are personally responsible for making sure that your dryer:

- Is installed by a qualified installer.
- Is properly installed and leveled in a well ventilated room* on a floor that can support the weight.
- Is connected to the right outlet, electric supply and grounding.*
- Is properly connected to fuel and exhaust systems.*
- Is used only for jobs normally expected of home automatic dryers.
- Is properly maintained.
- Is protected from the weather and kept where the temperature is above 45°F (7.2°C).

- Is not run where there may be explosive fumes.
- Is not used by children or anyone unable to operate it properly.

*See the "INSTALLATION INSTRUCTIONS" for complete information.

SAFETY FIRST

ALWAYS unplug the power supply cord or turn off the electrical power before attempting to service the dryer. **Shut off the GAS VALVE** if yours is a gas dryer.

ALWAYS shut off the gas valve before leaving on vacation.

NEVER use flammable fluids (drycleaning solvents, gasoline, kerosene) in or near your dryer.

ALWAYS hand launder or air dry fabrics treated with flammable fluids before putting them into your dryer.

NEVER dry items containing wax or paint in the dryer. The fumes can create a FIRE HAZARD.

FIRE HAZARD and **DAMAGE** to some materials can result from:

- drying heat sensitive materials with heat.
- operating the dryer with the lint screen loose, damaged or missing.
- allowing lint to build up inside the dryer.

NEVER allow children to operate, play with, or crawl inside the dryer.

NEVER operate the dryer if:

- It is not working right.
- It is damaged.
- Parts are missing.
- All panels are not in place.

DO NOT let dust, lint, paper, rags, chemicals, etc., pile up around or under the dryer. **DO NOT** install against drapes or curtains.

• **SAVE THESE INSTRUCTIONS** •

FOR YOUR SAFETY

IF YOU SMELL GAS:

1. OPEN THE WINDOWS.
2. DON'T TOUCH ELECTRICAL SWITCHES.
3. EXTINGUISH ANY OPEN FLAME.

4. IMMEDIATELY CALL YOUR GAS SUPPLIER.

DO NOT STORE OR USE GASOLINE OR OTHER FLAMMABLE VAPORS AND LIQUIDS IN THE VICINITY OF THIS OR ANY OTHER APPLIANCE.

PARTS AND FEATURES

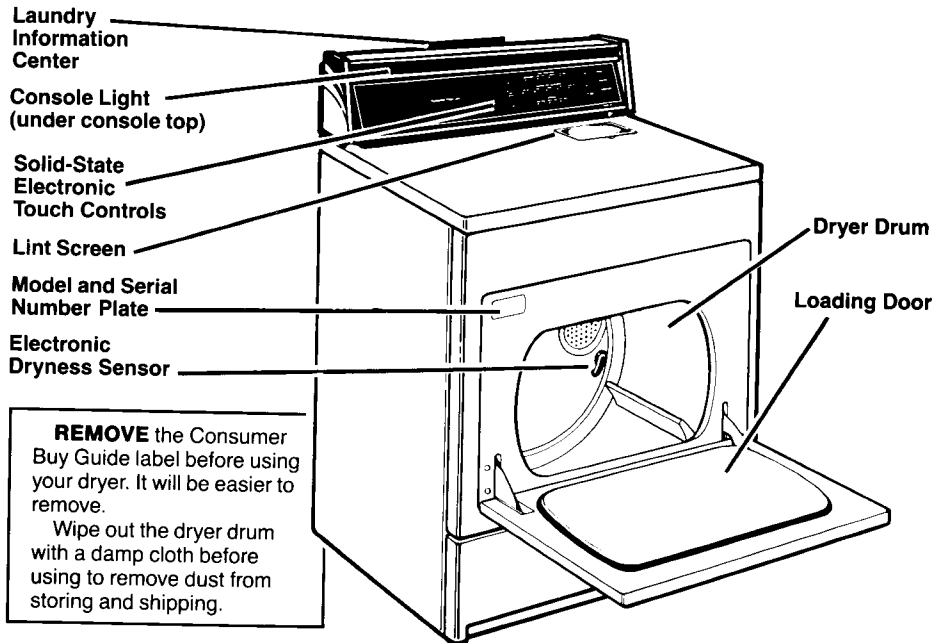

Copy Your Model and Serial Numbers Here

When you need service or call with a question, have this information ready:

1. **Complete** Model and Serial Numbers (from plate located as shown).
2. Purchase date from sales slip.

Copy this information in these spaces. Keep this book in the Laundry Information Center with your "Dryer Guide" and sales slip.

Please complete and mail the Owners Registration Card furnished with this product.

Model Number _____

Serial Number _____

Purchase Date _____

Service Company Phone Number _____

SETTING A SELECTION AND STARTING YOUR DRYER

Before starting your dryer, be sure laundry is sorted and loaded properly (see the "Dryer Guide"). **Be sure the door is tightly closed.**

The automatic dryer has Solid-State Electronic Controls. Read instructions carefully before setting any drying cycles.

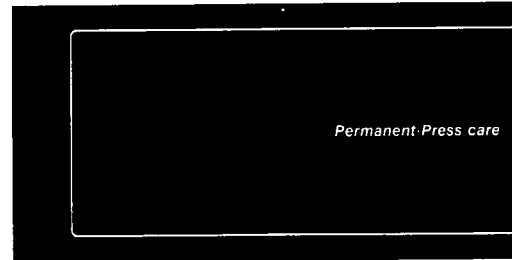

1. Touch "ON"

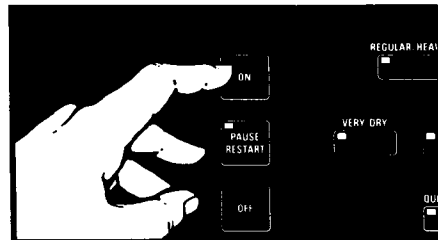

- The dryer will power up, but the drum will not start turning. The Cycle Selection lights will scan and the Smooth Guard and Cycle Sentry lights will come on. The controls are now ready for selection.

NOTE: The dryer will continue to scan the Cycle Selection lights until a selection has been made. You have 15 minutes to make a selection before the dryer automatically shuts off.

2. Touch a CYCLE Selection

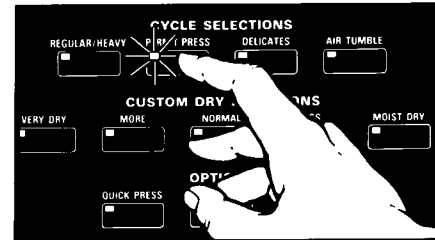

- Touch a CYCLE Selection that matches the load type you want to dry. The light will stay on in the selection you choose. The dryer selects the correct temperature for the load type selected.

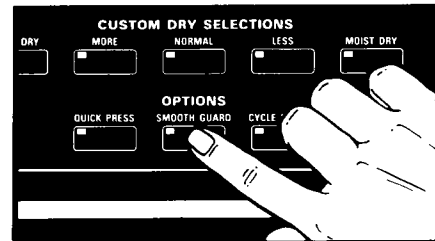

- If SMOOTH GUARD and /or CYCLE SENTRY Options are not wanted, touch the desired pad(s) to cancel the options(s). The light(s) will go off.

NOTE: The AIR TUMBLE selection automatically provides 20 minutes of timed drying without heat.

CAUTION: Drying plastic or rubber items with heat may damage the items or be a FIRE HAZARD.

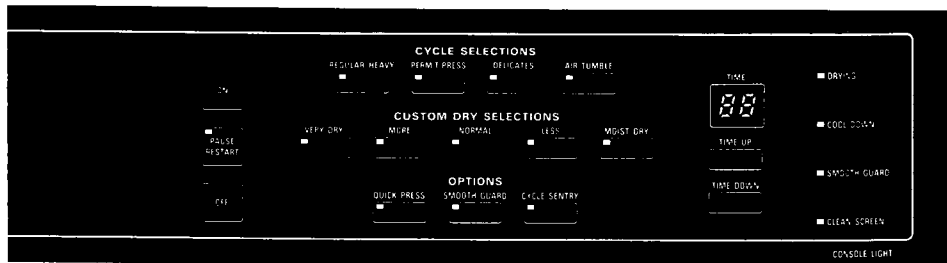

3. Touch a CUSTOM DRY or TIME Selection

CUSTOM DRY

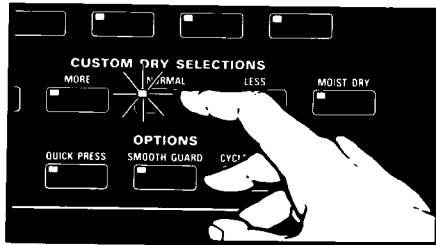

Touch the CUSTOM DRY Selection that describes the dryness you want for the load.

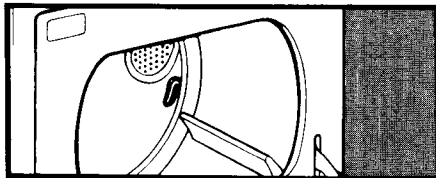

A sensor on the back of the dryer drum senses the moisture in the load. When the selected dryness has been reached, the dryer automatically shuts off. **If dryness is not what you expected, use the following as a guide:**

- For the first few loads, use NORMAL. When finished, check the load for desired dryness.
- If the load is not dry enough, use MORE or VERY DRY the next time.
- If the load is too dry, use LESS the next time.
- If you plan to iron the clothes after drying, use MOIST DRY.

TIME

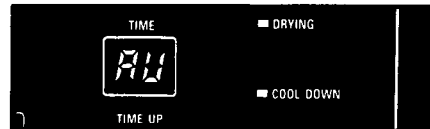

When selecting a CUSTOM DRY Selection, the TIME Display will show "AU." After a period of tumbling, the dryer will calculate and show the remaining time needed to dry the load. This time will count down until the cycle ends.

To Manually Set TIME:

- Touch TIME UP or TIME DOWN Pad for loads you want to dry by time. The TIME Display will show 30 minutes.
- If more time is wanted, touch TIME UP until the time you want shows in the Display. TIME can be set up to 99 minutes.
- If less time is wanted, touch TIME DOWN until the time you want shows in the Display.

The TIME Selection is good for very small loads or large bulky items.

IMPORTANT: If the load you have finished drying is not dry enough:

1. Touch "OFF" then touch "ON:"
2. Touch a CUSTOM DRY Selection for the load type.
3. Set TIME for 20 minutes.

Remember to select a different dryness setting for the next similar load.

OPTIONS

QUICK PRESS Option

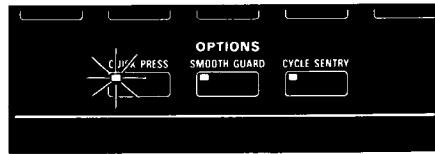

This selection is useful for removing wrinkles from items which have been packed in suitcases or closets. Touching the QUICK PRESS Pad automatically gives you 15 minutes of tumbling at the medium fabric temperature and 5 more minutes of cool-down without heat. The TIME Display will automatically show 20 minutes.

For best results, QUICK PRESS only a few items at a time. Put them on hangers or fold them as soon as the dryer stops.

SMOOTH GUARD Option

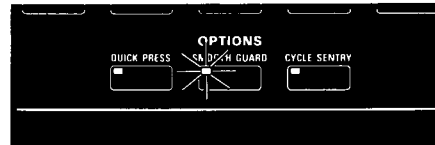

When SMOOTH GUARD is on, it takes over automatically when the dry cycle is completed.

SMOOTH GUARD tumbles the load, without heat, every 5 minutes to prevent wrinkles that set in when the load remains in the dryer. It continues up to 2½ hours or until the door is opened to remove the clothes.

- SMOOTH GUARD Indicator Light will stay on as long as the dryer is running. **Remember that SMOOTH GUARD is selected automatically every time you use the dryer.**
- If the door is opened or SMOOTH GUARD is cancelled during operation, the dryer will shut off.

To cancel SMOOTH GUARD:

- Touch SMOOTH GUARD Pad any time during the cycle. The light will go off showing that the option has been cancelled.

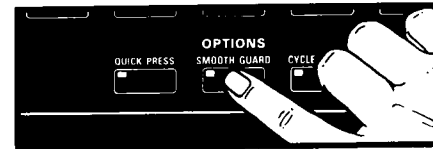

CYCLE SENTRY Signal Option

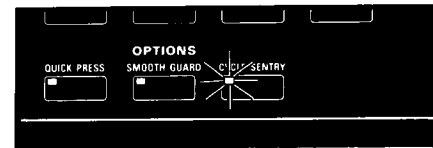

The dryer will automatically beep 5 times at the end of a cycle. The dryer will also beep every 5 minutes when tumbling in SMOOTH GUARD.

These signals tell you the dryer cycle is finished and the load can be removed.

- The light will stay on when the CYCLE SENTRY is ON.
- The signal loudness is not adjustable.

To Cancel CYCLE SENTRY:

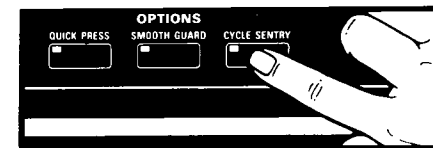

- Touch CYCLE SENTRY Pad any time during the cycle. The light will go off showing that the option has been cancelled.

FEATURES

The Indicator Lights

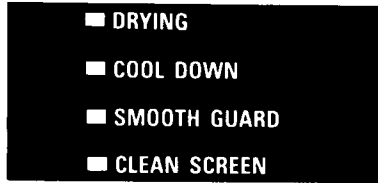

The indicator lights show what portion of the drying cycle the dryer is in: DRYING, COOL DOWN, SMOOTH GUARD.

DRYING indicates the dryer is in the drying portion of the cycle.

COOL DOWN indicates that the dryer is in the COOL-DOWN portion of the cycle. (See "Cool Down times" on this page.)

SMOOTH GUARD indicates the dryer is in SMOOTH GUARD. (See page 6 for more SMOOTH GUARD information.)

CLEAN SCREEN

Clean the lint screen before each load. If you neglect to clean the lint screen, the CLEAN SCREEN light will glow. This light lets you know the air flow is being restricted. Restricted air flow causes longer drying times and can become a safety hazard.

Turn off the dryer and clean the lint screen as shown on page 10.

PAUSE/RESTART Pad

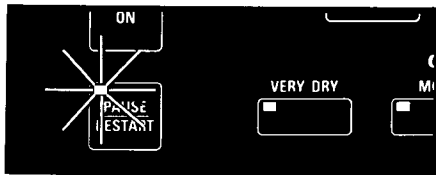

The PAUSE/RESTART Pad allows you to stop the dryer to check the load, clean the lint screen, or to provide additional cycle selection time.

When PAUSE/RESTART is touched, the dryer stops and the indicator light for the cycle you were using flashes. The dryer will remember where it was in that cycle for up to 15 minutes. To restart the dryer, touch PAUSE/RESTART again.

If the dryer is not restarted within 15 minutes, it will automatically shut off.

AIR TUMBLE Selection

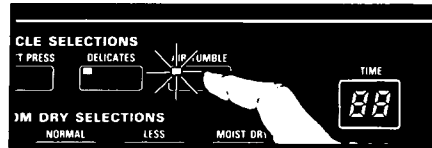

AIR TUMBLE automatically provides 20 minutes of timed drying without heat. If more or less time is wanted, touch the corresponding TIME Pad. **A CUSTOM DRY Selection can not be used with AIR TUMBLE.**

CAUTION: Drying plastic or rubber items with heat may damage the items or be a FIRE HAZARD.

Cushioned Heat

The dryer automatically reduces the heat settings in REGULAR HEAVY and PERM'T PRESS cycles. During the last 7 minutes of each of these cycles the dryer temperature **immediately** reduces to a lower setting. **COOL-DOWN takes over automatically after Cushioned Heat is finished.** This helps prevent overdrying.

Cool Down Times

In all cycles, the heat shuts off before the dryer stops tumbling. This cool down time helps:

- Keep wrinkles from setting in.
- Make handling the hot load items easier.

This chart suggests fabric loads and cycle selections.

TYPE OF LOAD	CYCLE SELECTION
<p>Cottons and Linens EXTRA HEAVY – Bedspreads, mattress pads, quilts. HEAVYWEIGHT FABRICS – Towels, jeans, corduroys, work clothes. MEDIUMWEIGHT COTTONS – Sheets, pillowcases, cotton underwear, diapers. LIGHTWEIGHT COTTONS – Batistes, organdies, lingerie.</p>	<p>REGULAR/ HEAVY</p>
<p>Permanent Press, Synthetics and Blends HEAVYWEIGHT FABRICS – Work clothes, jackets, raincoats. MEDIUMWEIGHT FABRICS – Shirts, play clothes, sheets, slacks. LIGHTWEIGHT FABRICS – Lingerie, blouses, dresses.</p>	<p>PERM'T PRESS</p>
<p>Knits HEAVYWEIGHT – Cottons, rayons, blends, t-shirts, slacks, shirts. LIGHTWEIGHT – Synthetics (polyester, acrylic, etc.) and blend, lingerie, blouses, dresses.</p>	<p>PERM'T PRESS</p>
<p>Lightweight and Delicate Fabrics Sheer curtains (2 or 3 panels). Gauze, lace, etc.</p>	<p>DELICATES</p>
<p>Rubber, Plastic, Heat-Sensitive Fabrics FOAM RUBBER – Pillows, bras, stuffed toys. PLASTICS – Shower curtains, tablecloths. RUBBER-BACKED RUGS – Fluff bedding or dust drapes.</p>	<p>AIR TUMBLE</p>
<p><i>WARNING: Drying heat-sensitive materials with heat can damage them or be a FIRE HAZARD.</i></p>	

DRYING TIPS

Mixed Loads

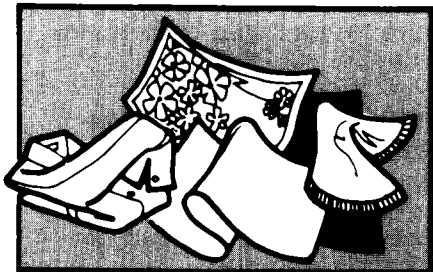

When drying a load with different kinds and weights of fabrics, use the setting suggested for the lightest fabrics.

NOTE: Overdrying can cause shrinkage, static cling and damage to some fabrics.

To help reduce wrinkling, take the load from the dryer as soon as tumbling stops. This is very important for permanent press, knits and synthetic fabrics.

Drying Times



Drying times will vary depending on one or more of the following:

- Amount of moisture in the clothes.
- Type and weight of the fabric.
- Size of the load.
- Room temperature around the dryer.
- Temperature of the wash rinse water.
- Amount of lint in the lint screen.
- Dryer temperature selection.

See your "DRYER GUIDE" for more information.

Using the Drying Rack

The drying rack lets you dry items that you may not want to tumble. For example; sneakers, stuffed toys, knitted wool, etc.

The rack does not move, but the drum turns around the rack. **Make sure nothing hangs over the edges of the rack.**

To Use the Drying Rack

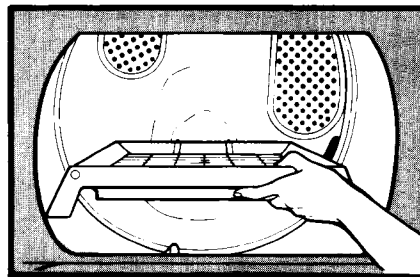

1. Fit rear legs of rack into indentations in back wall of dryer.
2. Lower front so legs rest on dryer opening.

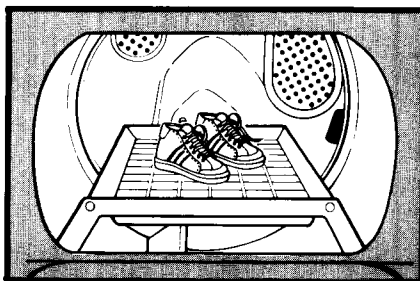

3. Put wet items on top of the rack. **Leave space between items** so air can reach all surfaces.
4. Close the door and set the time desired for drying.

continued on next page

Drying Time Selection

The drying time will depend on how much moisture the items hold. The following chart suggests CYCLE Selections with temperature settings that match the different kinds of items that might best be rack dried.

TO RACK DRY:	CYCLE SELECTION
Wool Sweaters Block to shape and lay flat on the rack.	DELICATES
Stuffed Toys or Pillows Cotton or polyester fiber filled. Foam rubber filled.*	PERM'T PRESS TUMBLE AIR
Sneaker or Canvas Shoes* *WARNING: Drying with heat may damage the foam rubber and will be a FIRE HAZARD.	TUMBLE AIR

LINT SCREEN

Clean the lint screen before each load. A screen blocked by lint can increase drying time and may be a FIRE HAZARD.

WARNING: DO NOT run the dryer with the lint screen loose, damaged or missing. Doing so can cause overheating, can damage fabrics and can be a FIRE HAZARD.

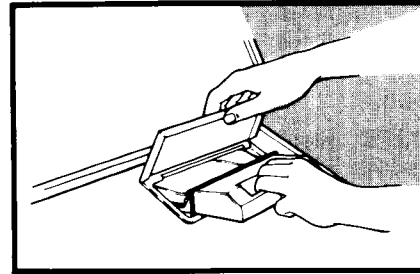

1. Open the lid and pull the lint screen straight out.

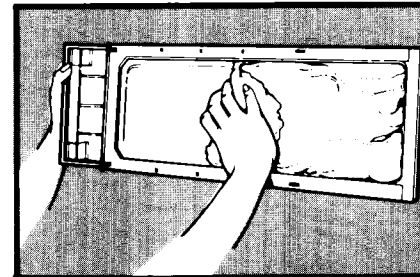

2. **ROLL** the lint off the screen with your fingers. **Do Not rinse or wash the screen.**
3. Push the screen firmly back into place.

LINT REMOVAL

Lint can gather inside the dryer and create a fire hazard. **This lint should be removed every 2 to 3 years, or more often, depending on dryer usage.**

WARNING:

- **Avoid electrical shock hazard. Unplug the power supply cord or turn off the electrical power.**
- **Avoid injury or damage. Do not put hands inside the cabinet.**
- **Make sure the dryer is cool.**

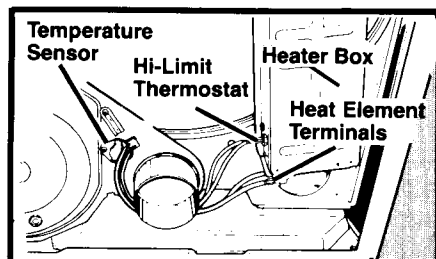

ELECTRIC DRYERS

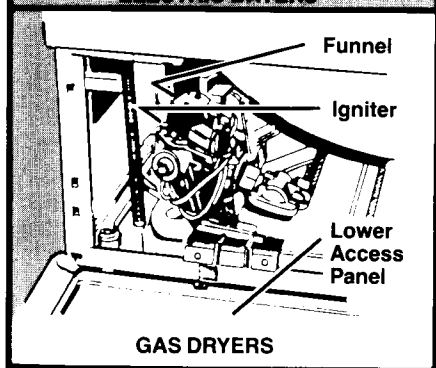

GAS DRYERS

Cleaning should be done by a qualified person.

1. Remove back panel (electric) or lower access panel (gas).
2. Avoid damaging wires, thermostats, funnel or igniter.
3. Remove lint from shaded area with a soft brush or vacuum cleaner.
4. Replace panel, reconnect and re-level dryer.

CARING FOR YOUR DRYER

The Console Light

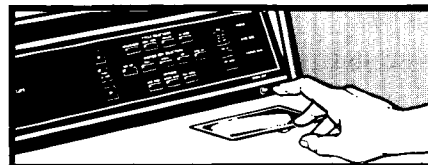

The fluorescent console light is under the console top. The **Console Light** switch is on the bottom right side of the console. To turn on the light, push in the switch and hold it for a second or two. Push the switch again to turn the light off.

Replacing the Console Light

WARNING: To avoid possible shock hazard, unplug dryer power cord or turn off electrical power at the main power supply.

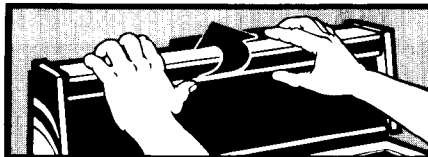

1. Flip up the console top by grasping it with both hands near each end and lifting the front edge up.

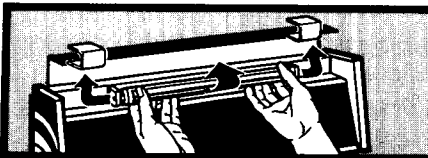

2. Remove lamp socket safety cover at both ends of fluorescent tube.
3. Grasp fluorescent tube at both ends. Turn tube away from you until both ends come out of the receptacles. Replace with a 15-watt cool-white (#F15T8) fluorescent tube. Close the console top.
4. Replace lamp socket safety covers.
5. Plug in the dryer power cord or turn the electrical power back on at the main power supply.

The Drum Light

The Drum Light automatically comes on inside the dryer drum when the dryer loading door is opened.

Replacing the Drum Light

WARNING: To avoid possible shock hazard, unplug the dryer power cord or turn off the electrical power at the main power supply.

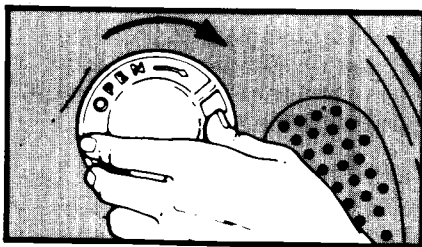

1. Open the dryer door and remove light bulb cover by turning it clockwise.

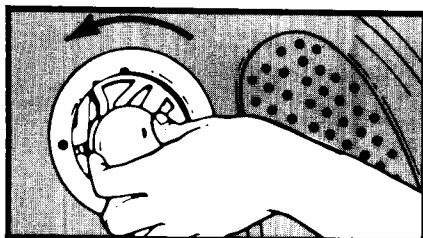

2. Remove the light bulb by turning it counterclockwise.
3. Replace the bulb with a 40-watt appliance bulb only.
4. Replace the light bulb cover and lock it in place by turning counterclockwise.

CAUTION: The bulb cover must be securely in place during dryer operation to prevent overheating and possible damage to fabrics. Operating the dryer with the bulb cover removed can cause the dryer to fail or create a FIRE HAZARD.

Dryer Care

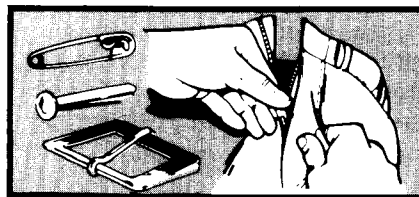

REMOVE LOOSE AND SHARP OBJECTS (such as pins, buckles, etc.) from clothing before drying. Close metal zippers.

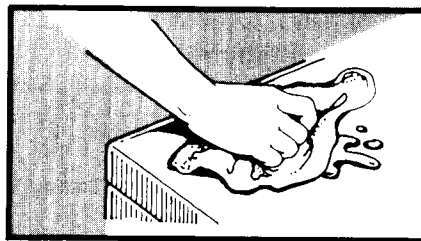

WIPE OFF ALL SPILLS with a damp, soft cloth. Spills allowed to remain may dull or damage the finish.



NEVER leave wet or damp laundry in your dryer.

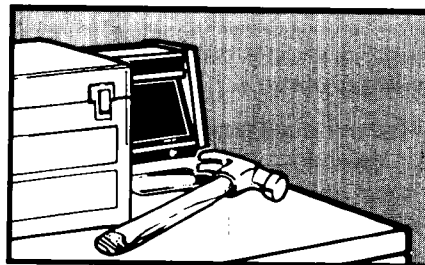

SHARP OR HEAVY OBJECTS should never be put on or in the dryer. Check pockets for bolts, nuts, etc.



SOME PRETREATMENT PRODUCTS can damage the dryer buttons, consoles and finishes. Do not use these products on or near your dryer.

Cleaning the Dryer Interior

WARNING: Before cleaning interior, unplug power supply cord or turn off electrical power to avoid electrical hazard.

Garments which contain unstable dyes, such as denim blue jeans or brightly colored cotton items, may discolor the dryer interior. If the interior is discolored, clean with one of the following methods to avoid staining later load items.

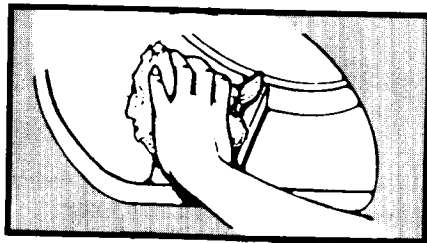

Powdered laundry detergent and very warm water

Make a paste with detergent and very warm water. Apply paste to a soft cloth and scrub area until all excess dye is removed. Wipe thoroughly with a damp cloth. Tumble a load of rags. **-OR-**

Liquid spray household cleaner

Spray on stained area. Rub with a cloth until all excess dye is removed. Tumble a load of rags.

Vacation Care

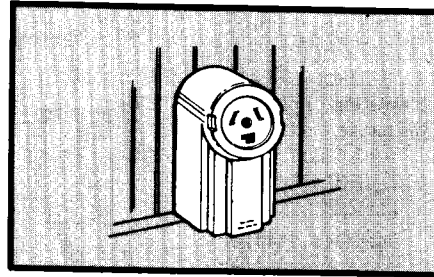

1. Unplug the power cord or turn off the electrical power.

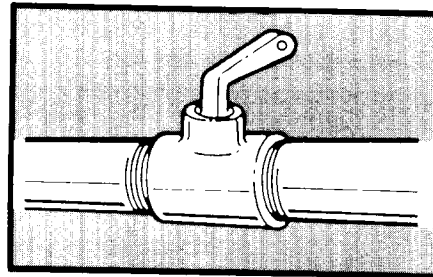

2. For gas dryers, close the gas valve.

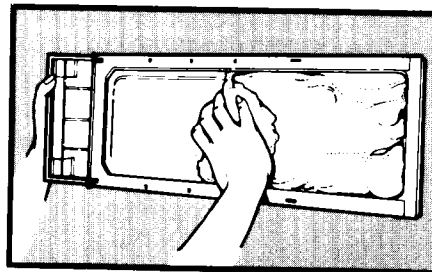

3. Clean the lint screen.

IF YOU NEED SERVICE OR ASSISTANCE

Follow These Steps

1. If your dryer should fail to operate, review the following list before calling your dealer. You could save the cost of a service call.



If your dryer does not run:

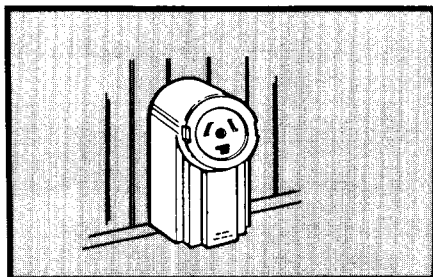

- Is the power supply cord plugged into a live circuit with the proper voltage?
- Is the door closed tightly?

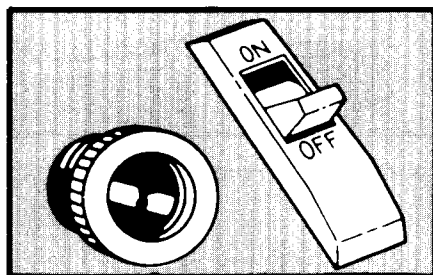

- Have you checked your home's main fuses or circuit breaker box?
- Did you touch "ON"?
- Did you touch a CYCLE Selection?

If your dryer does not heat:

- The AIR TUMBLE Selection is without heat.
- The last minutes of all cycle selections are without heat.

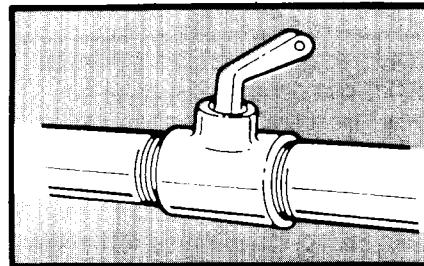

- Is the gas turned on? If not, touch "OFF" Pad. Turn on the gas. Wait 5 minutes, then touch "ON" Pad and reset the controls.
- An electric dryer requires two fuses or a circuit breaker. If one fuse is blown, the dryer may run, but not heat.

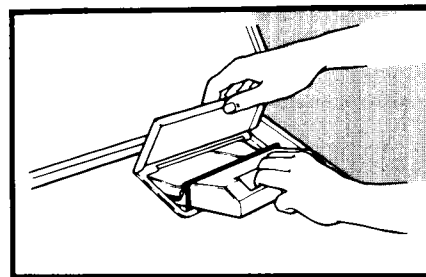

If drying times seem too long:

- Is the lint screen clean?
- See page 6 of your "DRYER GUIDE."



If the TIME Display shows "E1" or "E2," call for service.

2. If the problem is not due to one of the above items, first call your dealer or repair service he recommends.
 - All service should be handled locally by the dealer from whom you purchased the unit or an authorized KitchenAid servicer.
3. In the event you are unable to obtain the name of a local authorized KitchenAid servicer, call KitchenAid Consumer Affairs, TOLL FREE: 1-800-422-1230
 - A Consumer Affairs representative can recommend a qualified service company in your area.

If you must call or write, please provide: Model Number, Serial Number, Date of Purchase and complete description of the problem.

Write to:

KitchenAid Consumer Affairs
KitchenAid, Inc.
3800 Space Drive
Dayton, Ohio 45414

4. If you are not satisfied with the action taken, contact the Major Appliance Consumer Action Panel (MACAP). MACAP is a group of independent consumer experts that voices consumer views at the highest levels of the major appliance industry. Contact them only when the dealer, authorized servicer or KitchenAid, Inc., have failed to resolve your problem.

Major Appliance Consumer
Action Panel
20 North Wacker Drive
Chicago, Illinois 60606

MACAP will in turn inform us of your action.

KitchenAid™

DRYER WARRANTY

LENGTH OF WARRANTY:	KITCHENAID WILL PAY FOR:	KITCHENAID WILL NOT PAY FOR:
ONE YEAR FULL WARRANTY FROM DATE OF PURCHASE.	Replacement parts and repair labor to correct defects in materials or workmanship. Service must be provided by an authorized KitchenAid servicing outlet.	<p>A. Service calls to:</p> <ol style="list-style-type: none"> 1. Correct the installation of the dryer. 2. Instruct you how to use the dryer. 3. Replace house fuses or correct house wiring. 4. Correct house plumbing. <p>B. Repairs when dryer is used in other than normal home use.</p> <p>C. Damage resulting from accident, alteration, misuse, abuse, improper installation or installation not in accordance with local electrical or plumbing codes.</p> <p>D. Any labor costs during the limited warranties.</p> <p>E. Replacement parts or repair labor costs for units operated outside the United States.</p> <p>F. Pick up and delivery. This product is designed to be repaired in the home.</p>
FIVE YEAR LIMITED WARRANTY ONE YEAR FULL PLUS SECOND THROUGH FIFTH YEAR LIMITED FROM DATE OF PURCHASE.	Replacement parts for any electric element on electric models or any burner on gas models. Rust-through protection on cabinet assembly.	
TEN YEAR LIMITED WARRANTY ONE YEAR FULL PLUS SECOND THROUGH TENTH YEAR LIMITED FROM DATE OF PURCHASE.	Replacement of the dryer drum if it rusts through due to defective materials or workmanship.	

KITCHENAID, INC. DOES NOT ASSUME ANY RESPONSIBILITY FOR INCIDENTAL OR CONSEQUENTIAL DAMAGES. Some states do not allow the exclusion or limitation of incidental or consequential damages, so this exclusion or limitation may not apply to you.

This warranty gives you specific legal rights and you may also have other rights which vary from state to state.

KitchenAid, Inc.

St. Joseph, Michigan, USA 49085

Free Manuals Download Website

<http://myh66.com>

<http://usermanuals.us>

<http://www.somanuals.com>

<http://www.4manuals.cc>

<http://www.manual-lib.com>

<http://www.404manual.com>

<http://www.luxmanual.com>

<http://aubethermostatmanual.com>

Golf course search by state

<http://golfingnear.com>

Email search by domain

<http://emailbydomain.com>

Auto manuals search

<http://auto.somanuals.com>

TV manuals search

<http://tv.somanuals.com>