

Use and Care Guide



KitchenAid® FOR THE WAY IT'S MADE.™

A Note to You	2
Understanding Dryer Safety	3
Getting to Know Your Dryer	5
Operating Your Dryer	6
Before starting your dryer ...	6
Using the electronic touch controls	6
Starting your dryer	6
Stopping/restarting your dryer	7
Selecting the right cycle and setting	7
Using Automatic drying	8
Using Timed drying	9
Selecting cycles/temps	10
Other Features	13
Caring for Your Dryer	16
Laundry Tips	19
Troubleshooting	23
Requesting Assistance or Service	25
Warranty	28

1-800-422-1230

Call with questions or comments.

KITCHENAID® Dryers

Models: KEYW977B KGYW977B

2/95

PART NO. 3392994

A Note to You

Thank you for buying a KitchenAid® appliance!

KitchenAid appliances have everything you would expect of a superior appliance, plus the distinct style and thoughtful details which contribute to the overall look of your home and your enjoyment of it. To ensure that you enjoy many years of trouble-free operation, we developed this Use and Care Guide. It contains valuable information concerning how to operate and maintain your new appliance properly and safely. Please read it carefully.

Also, please complete and mail the enclosed Product Registration Card.

Your safety is important to us.

This guide contains safety statements under warning symbols. Please pay special attention to these symbols and follow any instructions given. Here is an example of the use of the symbol.

WARNING

This symbol will help alert you to such dangers as personal injury, burns, fire, and electrical shock.

Our Consumer Assistance Center telephone number, 1-800-422-1230, is toll-free 24 hours a day.

If you have a question concerning your home appliance's operation, or if you need service, call our toll-free Consumer Assistance Center telephone number for help. When calling, you will need to know your appliance's complete model number and serial number. You can find this information on the model and serial number label (see diagram on page 5). Record these numbers and purchase information below. You will need this information if you require service. Keep this book and the sales slip together in a safe place for future reference.

NOTE: You must provide proof of purchase or installation date for in-warranty service.

Model Number _____

Builder/Dealer Name _____

Serial Number _____

Address _____

Date Installed _____

Phone _____

Understanding Dryer Safety

⚠ WARNING

For your safety, the information in this manual must be followed to minimize the risk of fire or explosion or to prevent property damage, personal injury, or loss of life.

–Do not store or use gasoline or other flammable vapors and liquids in the vicinity of this or any other appliance.

–WHAT TO DO IF YOU SMELL GAS:

- Do not try to light any appliance.
- Do not touch any electrical switch; do not use any phone in your building.
- Clear the room, building, or area of all occupants.
- Immediately call your gas supplier from a neighbor's phone. Follow the gas supplier's instructions.
- If you cannot reach your gas supplier, call the fire department.

Installation and service must be performed by a qualified installer, service agency, or the gas supplier.



Understanding Dryer Safety

IMPORTANT SAFETY INSTRUCTIONS

⚠ WARNING

To reduce the risk of fire, electrical shock, or injury to persons when using your dryer, follow basic precautions, including the following:

- Read all instructions before using your dryer.
- Do not machine wash or machine dry items cleaned, washed, soaked in, or spotted with wax, paint, gasoline, oil, dry cleaning solvents, and other flammable fluids. The fumes can create a fire hazard or explosion. Always hand wash and line dry items containing these materials.
- Do not allow children to operate, play with, or crawl inside your dryer. Supervise children when your dryer is used near children.
- Do not reach into a dryer if the drum is moving.
- When removing from service or discarding a dryer, always remove the door to prevent accidental entrapment.
- Do not dry rubber, rubber-like, and heat-sensitive materials with heat.
- Install and/or store dryer where it will not be exposed to the weather.
- Do not tamper with the controls.
- You are responsible for making sure that your dryer is installed, repaired, and has parts replaced by a qualified person.
- Use only fabric softeners specifically labeled as not being harmful to the dryer.
- Do not allow lint to build up inside the dryer or exhaust system. Cleaning should be done periodically by a qualified person.
- Clean lint screen before or after each load.
- Do not let dust, lint, paper, rags, chemicals, etc. pile up around or under the dryer.
- Dryer must be electrically grounded. See the Installation Instructions.

Understanding your responsibilities

- Never operate the dryer if:
 - it is not working right (i.e. noisy, too hot).
 - it is damaged.
 - parts are missing.
 - all panels are not in place.
 - the lint screen is loose, damaged, or missing.
- Unplug the power supply cord or turn off electrical power before attempting to service your dryer. Shut off gas valve if you have a gas dryer.
- Do not wash or dry items that are soiled with vegetable or cooking oil. These items may contain some oil after laundering. Due to the remaining oil, the fabric may smoke or catch fire by itself.
- Store flammable solvents or fluids away from your dryer.
- Dry cleaning solvents or fluids should never be put directly into your dryer.
- Be sure that your dryer:
 - is properly installed and leveled on a floor that can support the weight in a well-ventilated room.*
 - is connected to the proper outlet and electrical supply.*
 - is properly connected to fuel and exhaust systems (gas dryers must be vented outdoors).*
 - is not installed against draperies or curtains, or on carpet.*
 - is located in an area where the temperature is above 45°F (7°C).
 - is properly maintained.
 - is used only for jobs normally expected of home clothes dryers.
 - is not used by anyone unable to operate it properly.

*See the Installation Instructions for complete information.

– SAVE THESE INSTRUCTIONS –

Getting to Know Your Dryer

The parts and features of your dryer are illustrated below. Become familiar with all parts and features before using your dryer. Page references are included next to some features. Refer to those pages for more information about the features.

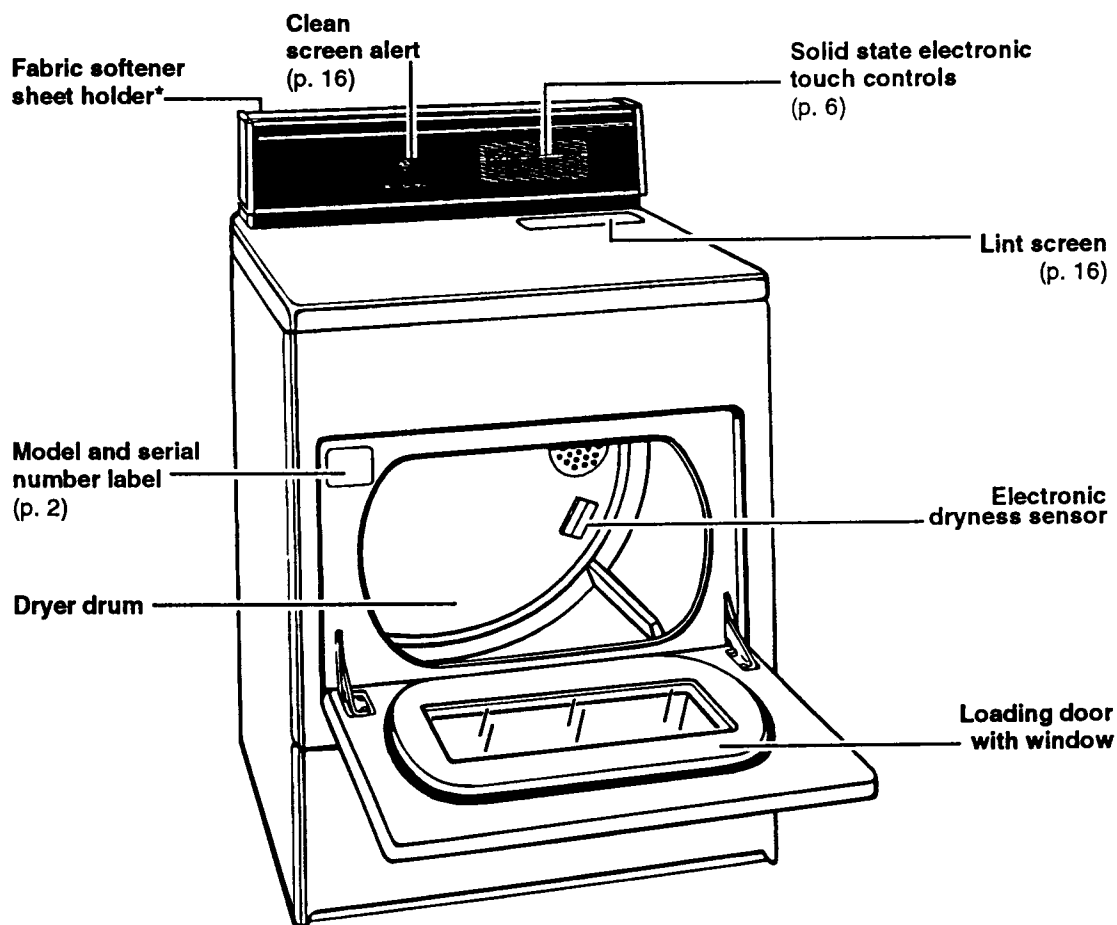

Other features not shown:

End-of-cycle signal (see page 13)
SMOOTH GUARD™ option (see pages 13, 14)
Drum light (see page 17)
Drying rack (see page 15)

*Optional accessory:

Fabric softener sheet holder
(Part No. 3388894)
See page 25 for ordering information.

Operating Your Dryer

This section tells you how to operate your dryer. Operating your dryer properly enables you to obtain the best possible results.

Before starting your dryer

Wipe the dryer drum with a damp cloth before using to remove dust from storing and shipping. Then place a load of clothes in the dryer and close the door.

NOTE: If your dryer has a Consumer Buy Guide, remove it and place it with your Use and Care Guide.

Using the electronic touch controls

Your new electronic dryer has solid state touch controls, as illustrated below. Many of the electronic features and options may be new to you. They are described on the following pages.

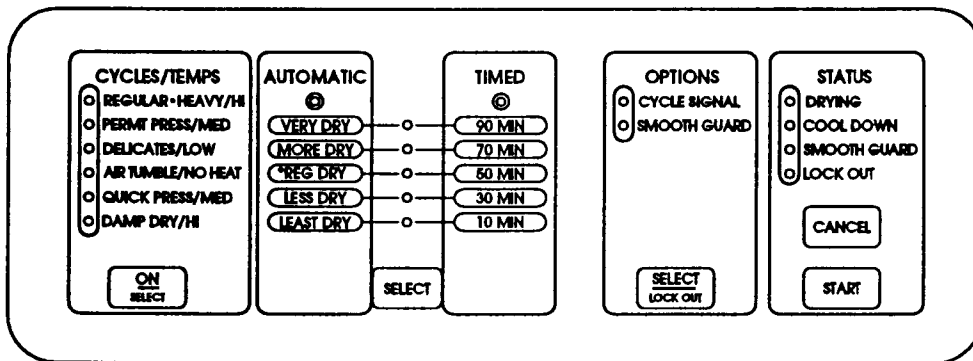

Audible tones guide your selections. You will hear:

- one tone if the dryer accepts your selection.
- three tones if the dryer does not accept your selection.

Starting your dryer

1. Press **ON/SELECT** until the light glows by the Cycle/Temp desired. See pages 11 and 12 for information about selecting cycles.

PRESS



YOU SEE

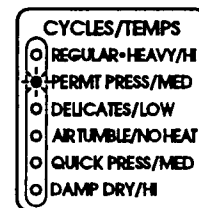

2. Press **SELECT** below any setting you want to change (Automatic or Timed, and Options). See pages 7-12 for information to help you make selections.



3. Press **START**.



NOTE: Your dryer stops automatically when the cycle ends.

Stopping/restarting your dryer

You can stop your dryer anytime during a cycle to add or remove clothes.

1. To stop the dryer, either:

- Open the dryer door.

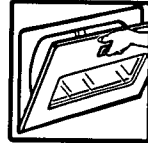

OR

- Press CANCEL.

PRESS



2. To restart the dryer:

- Close the dryer door.
- Select a new Cycle/Temp and other new settings (if desired).
- Press START.



Selecting the right cycle and setting

The following pages describe the cycles on your dryer. Refer to the charts on pages 11 and 12 for help in selecting drying cycles.

Drying guidelines

- Always follow care label directions when they are available.
 - To dry delicate fabrics, rubber, plastic, and heat-sensitive fabrics, always use the Air Tumble cycle or dry these items on a line or rack (see page 15).
 - The last few minutes of all cycles are without heat to make the load easier to handle.
 - To help reduce wrinkling, remove the load from the dryer as soon as tumbling stops. This is especially important for permanent press, knits, and synthetic fabrics.
 - Overdrying can cause shrinkage, static cling, and damage to some fabrics.
- Refer to pages 19-22 for information about:
 - sorting clothes for drying
 - choosing load sizes
 - drying tips
 - drying special-care items.
 - using dryer fabric softeners
 - saving energy
 - vacation care

Using Automatic drying

NOTE: Use the Energy Preferred Automatic Setting (*Reg Dry) to dry most loads.

In the Automatic cycles, the CUSHIONED HEAT™ Drying System automatically reduces the heat setting to prevent overdrying of fabrics. Your dryer automatically shuts off when the selected dryness is reached.

Reg Dry is the preset automatic dryness selected for the Regular•Heavy/Hi, Permt Press/Med, and Delicates/Low cycles. You can change the Automatic setting (or select a Timed setting) to match your load.

1. Press **ON/SELECT** until the light glows by the Cycle/Temp desired (Regular•Heavy, Permt Press, or Delicates).

PRESS



YOU SEE

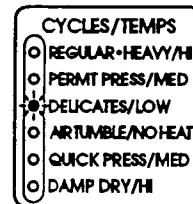

2. Press **SELECT** until the light glows below "Automatic" and by the desired Automatic dryness. (If desired, change Options selections. See pages 13-14.)

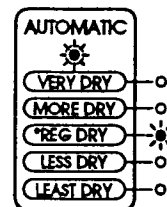

3. Press **START**.



NOTES:

- If the load is drier than you like, select **LESS DRY** or **LEAST DRY** the next time you dry a similar load.
- If the load is not as dry as you like, complete drying using a Timed setting. Select **MORE DRY** or **VERY DRY** the next time you dry a similar load.
- When you press **SELECT**, the Automatic dryness settings are selected first (starting with Reg Dry). Continue to press **SELECT** for a Timed setting (see page 9).

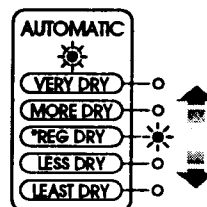

Using Timed drying

Use Timed drying to complete drying if some items are damp after Automatic drying. Timed drying is also useful to dry delicate items that require a short drying time.

1. Press **ON/SELECT** until the light glows by the Cycle/Temp desired.

PRESS



YOU SEE

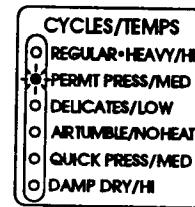

2. Press **SELECT** until the light glows below "Timed" and by the desired drying time. (If desired, change Options selections. See pages 13-14.)

NOTES:

- If you select the Regular•Heavy, Permt Press, or Delicates cycle, an Automatic dryness is preset.
- If you desire Timed dryness instead, continue to press **SELECT** until the Timed light glows (Automatic light shuts off) and the light glows by the desired time. If you pass the desired time, continue to press **SELECT** until the light glows under Timed and by the desired time.

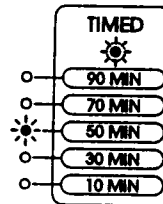

3. Press **START**.



Selecting cycles/temps

1. Press **ON/SELECT** until the light glows by the Cycle/Temp desired.

PRESS



YOU SEE

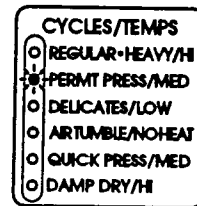

The "preset" selections are: Permt Press/Med, Automatic *Reg Dry with Cycle Signal and SMOOTH GUARD™ Options ON.

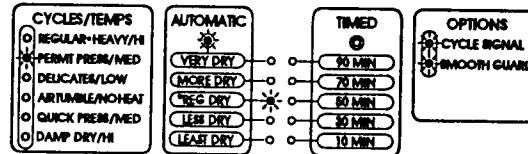

Preset selections

To select a different cycle/temp:

2. Press **ON/SELECT** until the light glows by the new Cycle/Temp. Your dryer makes selections for each Cycle/Temp. You can change these selections if desired. See the charts on pages 11 and 12 for the selection you want to change.

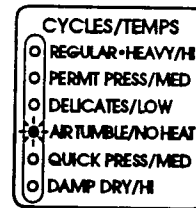

WARNING

Fire Hazard

Do not dry plastic or rubber items with heat. Use the Air Tumble cycle, or line dry.

Failure to do so could result in fire or damaged items.









Cycle suggestions

CYCLE/TEMP	USE FOR	CYCLE NOTES
<p>Regular/Heavy/Hi</p> <div style="border: 1px solid black; padding: 5px; width: fit-content;"> <p>CYCLES/TEMPS</p> <p><input checked="" type="radio"/> REGULAR-HEAVY/Hi</p> <p><input type="radio"/> PERMIT PRESS/MED</p> <p><input type="radio"/> DELICATES/LOW</p> <p><input type="radio"/> AIR TUMBLE/NO HEAT</p> <p><input type="radio"/> QUICK PRESS/MED</p> <p><input type="radio"/> DAMP DRY/Hi</p> </div> <p>Preset Selections</p> <p><input checked="" type="checkbox"/> REG DRY</p> <p><input type="checkbox"/> CYCLE SIGNAL</p> <p><input type="checkbox"/> SMOOTH GUARD</p>	<p>Cotton and Linens</p> <ul style="list-style-type: none"> • Extra Heavy or Heavyweight items; bedspreads, mattress pads, quilts, towels, jeans, corduroys, work clothes • Mediumweight items; sheets, cotton underwear, diapers 	<ul style="list-style-type: none"> • You may select a different Automatic dryness or use a Timed setting. Automatic drying will dry a load in less time than a Timed setting, and will be less likely to overdry.
<p>Permt Press/Med</p> <div style="border: 1px solid black; padding: 5px; width: fit-content;"> <p>CYCLES/TEMPS</p> <p><input type="radio"/> REGULAR-HEAVY/Hi</p> <p><input checked="" type="radio"/> PERMIT PRESS/MED</p> <p><input type="radio"/> DELICATES/LOW</p> <p><input type="radio"/> AIR TUMBLE/NO HEAT</p> <p><input type="radio"/> QUICK PRESS/MED</p> <p><input type="radio"/> DAMP DRY/Hi</p> </div> <p>Preset Selections</p> <p><input type="checkbox"/> REG DRY</p> <p><input checked="" type="checkbox"/> CYCLE SIGNAL</p> <p><input type="checkbox"/> SMOOTH GUARD</p>	<p>Cotton and Linens</p> <ul style="list-style-type: none"> • Lightweight; batistes, organdies, lingerie <p>Permanent Press, Synthetics, Blends</p> <ul style="list-style-type: none"> • Heavy or Mediumweight; work clothes, jackets, raincoats, shirts, play clothes, sheets, slacks <p>Knits</p> <ul style="list-style-type: none"> • Heavy or Mediumweight; cottons, rayons, blends, T-shirts, slacks, shirts, synthetics (polyester, acrylic, etc.) dress slacks, skirts, sweaters 	<ul style="list-style-type: none"> • Use the SMOOTH GUARD™ option with this cycle to ensure the best wrinkle-free drying.
<p>Delicates/Low</p> <div style="border: 1px solid black; padding: 5px; width: fit-content;"> <p>CYCLES/TEMPS</p> <p><input type="radio"/> REGULAR-HEAVY/Hi</p> <p><input type="radio"/> PERMIT PRESS/MED</p> <p><input checked="" type="radio"/> DELICATES/LOW</p> <p><input type="radio"/> AIR TUMBLE/NO HEAT</p> <p><input type="radio"/> QUICK PRESS/MED</p> <p><input type="radio"/> DAMP DRY/Hi</p> </div> <p>Preset Selections</p> <p><input type="checkbox"/> REG DRY</p> <p><input type="checkbox"/> CYCLE SIGNAL</p> <p><input checked="" type="checkbox"/> SMOOTH GUARD</p>	<p>Knits</p> <ul style="list-style-type: none"> • Lightweight; synthetics (polyester, acrylic, etc.) and blends, lingerie, blouses, dresses <p>Delicate Fabrics</p> <ul style="list-style-type: none"> • Sheer curtains (2 or 3 panels), gauze, lace, etc. 	<ul style="list-style-type: none"> • When drying very delicate fabrics, use a Less Dry setting to remove some moisture. Then shape and line dry to complete drying.

continued on next page

Operating Your Dryer

Cycle suggestions

CYCLE/TEMP	USE FOR	CYCLE NOTES
<p>Air Tumble/No Heat</p> <div style="border: 1px solid black; padding: 5px; width: fit-content;"> <p>CYCLES/TEMPS</p> <p><input type="radio"/> REGULAR-HEAVY/HI</p> <p><input type="radio"/> PERMIT PRESS/MED</p> <p><input type="radio"/> DELICATES/LOW</p> <p><input checked="" type="radio"/> AIR TUMBLE/NO HEAT</p> <p><input type="radio"/> QUICK PRESS/MED</p> <p><input type="radio"/> DAMP DRY/HI</p> </div> <p>Preset Selections</p> <p> 50 MIN</p> <p> CYCLE SIGNAL</p> <p> SMOOTH GUARD</p>	<p>Rubber, Plastic, or Heat Sensitive Items</p> <ul style="list-style-type: none"> • Bedding, plastic tablecloths, foam rubber pillows, stuffed toys, sneakers, etc. 	<ul style="list-style-type: none"> • See Warning on page 10. • This cycle is unheated and uses a 50-minute Timed setting that you can change. Select a time to match the items you are fluffing or drying.
<p>Quick Press/Med</p> <div style="border: 1px solid black; padding: 5px; width: fit-content;"> <p>CYCLES/TEMPS</p> <p><input type="radio"/> REGULAR-HEAVY/HI</p> <p><input type="radio"/> PERMIT PRESS/MED</p> <p><input type="radio"/> DELICATES/LOW</p> <p><input type="radio"/> AIR TUMBLE/NO HEAT</p> <p><input checked="" type="radio"/> QUICK PRESS/MED</p> <p><input type="radio"/> DAMP DRY/HI</p> </div> <p>Preset Selections</p> <p> 30 MIN</p> <p> CYCLE SIGNAL</p> <p> SMOOTH GUARD</p>	<ul style="list-style-type: none"> • Removing wrinkles from clothes that have been packed in a suitcase • Removing wrinkles from items not removed from the dryer at the end of a cycle 	<ul style="list-style-type: none"> • This cycle uses a fixed, 30-minute, Timed setting that cannot be changed. • As soon as the dryer stops, fold or put items on hangers.
<p>Damp Dry/Hi</p> <div style="border: 1px solid black; padding: 5px; width: fit-content;"> <p>CYCLES/TEMPS</p> <p><input type="radio"/> REGULAR-HEAVY/HI</p> <p><input type="radio"/> PERMIT PRESS/MED</p> <p><input type="radio"/> DELICATES/LOW</p> <p><input type="radio"/> AIR TUMBLE/NO HEAT</p> <p><input type="radio"/> QUICK PRESS/MED</p> <p><input checked="" type="radio"/> DAMP DRY/HI</p> </div> <p>Preset Selections</p> <p> 30 MIN</p> <p> CYCLE SIGNAL</p> <p> SMOOTH GUARD</p>	<ul style="list-style-type: none"> • Drying items to a damp level, or to dry items that do not require an entire drying cycle • Drying items you will press • Drying heavy cottons, such as jeans, which you do not want to become stiff 	<ul style="list-style-type: none"> • This cycle uses a fixed, 30-minute, Timed setting that cannot be changed.

Other Features

Read the information in this section to understand the special features your dryer has.

Using Cycle Signal and SMOOTH GUARD options

Your electronic dryer automatically selects the Cycle Signal and SMOOTH GUARD™ options when you press ON/SELECT. You can turn one or both options Off if desired.

PRESS



Options selection chart

Each time you press SELECT/LOCKOUT, you turn an option On or Off.			
PRESS			
SELECT LOCK OUT			
First Press	Second Press	Third Press	Fourth Press
Both options Off	Cycle Signal On	SMOOTH GUARD On	Both options On

Using end-of-cycle signal

Your dryer sounds a signal to let you know when the selected cycle is finished. The signal is helpful when drying permanent press, synthetics, and other items that should be removed from the dryer as soon as it stops.



The signal can be turned On or Off, as described above.

Understanding the SMOOTH GUARD™ option

When you are unable to remove a load from the dryer as soon as it stops, wrinkles can form. To protect your clothing from wrinkles, use the SMOOTH GUARD option.

- If you do not open the door within a few minutes after a cycle ends, the SMOOTH GUARD feature protects your load by tumbling it every few minutes for up to 150 minutes.
- The SMOOTH GUARD tumbling rear-ranges and fluffs the load to avoid wrinkles that set in when the load remains in the dryer.
- A signal will sound every few minutes during the SMOOTH GUARD cycle. The signal and the cycle will stop when the door is opened, or if you press CANCEL.

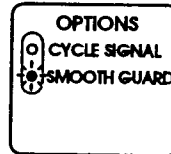

Using the Lock Out feature

This feature is useful to lock the electronic controls on your dryer, and to prevent the machine from being accidentally started by young children.

To lock/unlock control panel:

- Press and hold SELECT/LOCK OUT for 5 seconds.
- The light glows by Lock Out when the control panel is locked.

NOTE: You can select Lock Out only when your dryer is **not** running and your control panel is Off.

PRESS



YOU SEE

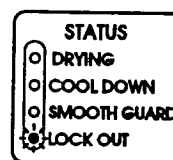

Status lights

Status lights glow when your dryer is operating. The lights indicate the various dryer functions.

If the status lights are blinking, there has been a power failure. Press CANCEL. Make new selections, if desired.

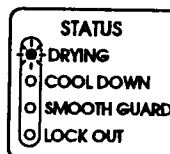

Using the drying rack

The drying rack lets you dry items that you may not want to tumble. The rack does not move, but the drum turns.

NOTE: The rack must be removed for normal tumbling.

1. Press the two supports at the rear of the rack into indentations in the back wall of the dryer.
2. Lower the front so the legs rest on the dryer opening.
3. Put wet items on top of the rack. Leave space between the items so air can reach all surfaces.

NOTE: Make sure nothing hangs over the edge of the rack.

4. Close the door.
5. Select the Air Tumble/No Heat cycle or a Timed dry cycle.
6. Press START.

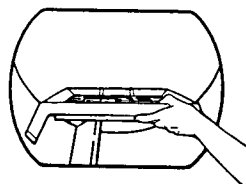

PRESS



⚠ WARNING

Fire Hazard

Do not dry heat-sensitive fabrics, plastic, rubber, or some stuffed items with heat. Use Air Tumble or line dry. Failure to do so could result in fire or damaged items.

Drying rack suggestions

Drying time will depend on how much moisture the items hold. The following chart suggests cycles and settings for the different kinds of items that might best be rack dried.

RACK DRY	CYCLE	TIME
Wool sweaters (Block to shape and lay flat on the rack)	Timed	50 min.
Stuffed toys or pillows (Cotton or polyester fiber filled)	Timed	50 min.
Stuffed toys or pillows (Foam rubber filled) Sneakers or canvas shoes	Air Tumble/No Heat	90 min.

Caring for Your Dryer

Dryers require regular maintenance. Follow the suggestions below to maintain your dryer properly.

Cleaning the lint screen

Every load cleaning

The lint screen is located under a lid on top of the dryer. **Clean it before each load.** A screen blocked by lint can increase drying time.

To clean:

1. Open the lid and pull the lint screen straight out.

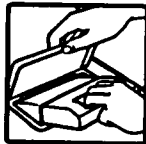

2. Roll lint off the screen with your fingers. Do not rinse or wash screen to remove lint. Wet lint is hard to remove.



3. Push the lint screen firmly back into place and close the lid.

IMPORTANT:

- Do not run the dryer with the lint screen loose, damaged, blocked, or missing. Doing so can cause overheating and damage to both the dryer and fabrics.
- Some towels made of synthetic fibers and natural fibers (polyester and cotton blends) may shed more lint than other towels, causing your dryer's lint screen to fill up faster. Be sure to remove lint from the lint screen before and after drying new towels.

As needed cleaning

Laundry detergents and fabric softeners can cause a residue buildup on the lint screen. Clean the lint screen with a nylon brush every six months or more frequently if it becomes clogged due to a residue buildup.

Use the following method:

1. Wet both sides of lint screen with hot water.

2. Wet a nylon brush with hot water and liquid detergent; scrub lint screen with the brush to remove residue buildup.

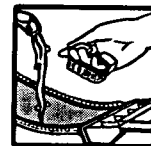

3. Rinse screen with hot water.
4. **Thoroughly** dry lint screen with a clean towel; replace in dryer.

Clean screen alert

The Clean Screen alert indicates excessive lint is present on your lint screen. A full lint screen restricts airflow and reduces drying efficiency. When the Clean Screen alert light glows, stop the dryer immediately and clean the lint screen.

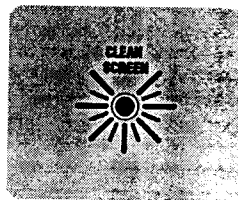

NOTE: Clean your lint screen before each load. Do not wait for the clean screen light to glow.

Cleaning the dryer exterior and window

Clean the dryer exterior and window with a soft, damp cloth. Wipe and dry with a soft cloth.

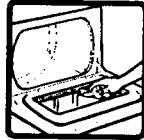

Cleaning the dryer interior

Garments which contain unstable dyes, such as denim blue jeans or brightly colored cotton items, may discolor the dryer interior.

To clean dryer drum:

1. Make a paste with detergent and very warm water.
2. Apply paste to a soft cloth and scrub area until all excess dye is removed.

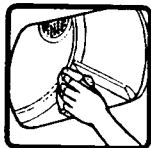

3. Wipe thoroughly with a damp cloth.
4. Tumble a load of rags to dry.

⚠ WARNING



Explosion Hazard

- Turn off the electrical power before cleaning the dryer interior.
 - Make sure the dryer is cool.
 - Use nonflammable cleaner.
- Failure to do so could result in electrical shock or injury, fire, or explosion.

Changing the drum light

The dryer light automatically turns on inside the dryer drum when you open the door.

To change drum light:

1. Unplug the dryer or disconnect the electricity leading to the dryer at the main power supply.
2. Open the dryer door. Remove the light bulb cover from the back wall of the dryer by turning the cover clockwise. 
3. Remove the light bulb by turning it clockwise.
4. Replace the bulb with a 40-watt appliance bulb only.
5. Replace the light bulb cover and lock in place by turning counterclockwise. 
6. Reconnect power supply.

⚠ WARNING

Electrical Shock and Fire Hazard

- Before removing light bulb, either unplug the dryer or disconnect the dryer at the main power supply.
- The bulb cover must be in place during dryer operation to prevent overheating and possible damage to fabrics. Operating the dryer with the bulb cover removed can cause the dryer to fail or create a fire hazard.



Caring for Your Dryer

Removing accumulated lint

Lint can gather inside the dryer and be a fuel for fire. It is recommended that lint be removed every 2 to 3 years, or more often, depending on dryer usage. Cleaning should be done by a qualified person. If you have any questions, please call our Consumer Assistance Center at 1-800-422-1230.

1. Unplug the power supply cord or turn off the electrical power.
2. Remove back panel (electric) or lower front access panel (gas). See the Installation Instructions.
3. Remove lint from shaded area in illustration with a soft brush or vacuum cleaner. Avoid damaging wires, thermostats (electric), funnel (gas), or ignitor (gas).
4. Replace panel; reconnect and level dryer again, if necessary.

⚠ WARNING

Electrical Shock and Personal Injury Hazard

- Unplug the power supply cord or turn off the electrical power before removing dryer panels.
- Make sure the dryer is cool.
- Dryer parts can have sharp edges. Use care when handling.

Failure to do so could result in electrical shock or personal injury.

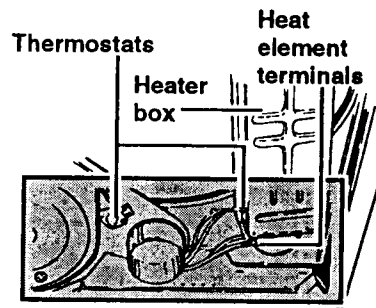

Electric dryer with back panel removed

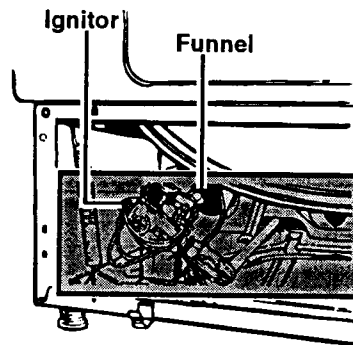

Gas dryer with lower front access panel removed

Laundry Tips

This section provides information on preparing clothes for drying, drying guidelines, and instructions for drying special-care items.

NOTES:

- Refer to your washer Use and Care Guide for proper washing techniques and additional laundry tips.
- See pages 3 and 4 of this book for Important Safety Information.

Sorting clothes

- Separate dark from light colors; colorfast from non-colorfast. Items properly sorted for washing are usually properly sorted for drying. 
- Separate heavy fabrics (denim, towels) from light fabrics (synthetics, permanent press).

- Separate lint givers (towels, chenille) from lint takers (corduroy, synthetics, permanent press). When possible, turn lint takers inside out.

Choosing load sizes

- Mix large items with smaller items. Load the dryer by the amount of space items take up, not by their weight. Do not overload the dryer. Overcrowding causes uneven drying and wrinkling, and can cause items to wear out faster (because of pilling). 
- You may need to rearrange large items (sheets, blankets, tablecloths) during a cycle to reduce balling or rolling up.

- For better tumbling action, when drying only a few small items, add one or two lint-free towels. This also prevents small, lightweight items from blocking airflow.
- Reduce wrinkling of permanent press items and synthetics by drying smaller loads and removing items from the dryer as soon as tumbling stops.

Drying tips

- Close zippers, snaps, and hooks to avoid snagging other items. Remove heat-sensitive trim that can be damaged by drying. Tie strings and sashes so they will not tangle. 
- Check garments to make sure all spots and stains were removed during the wash. Do not tumble dry soiled or stained items. Heat may permanently set stains.

- Sharp or metal objects can damage your dryer. Check pockets for pins, clips, money, bolts, nuts, etc. Do not lay these objects on your dryer after emptying pockets. Turn pockets inside out. 
- Place small items such as baby socks or hankies in a mesh bag for easier removal.
- Articles to be ironed should be removed from the dryer while still damp.



Drying special-care items

Most garments and household textiles have manufacturer's care labels with laundering instructions. **Always follow care label directions when they are available.** Pages 11 and 12 include drying instructions for most types of washables. The chart below provides drying instructions for special-care washables.

ITEMS	DRYING INSTRUCTIONS
Blankets and woolens •Cotton, rayon, synthetic blankets •Electric blankets, electric sheets, woolen blankets, washable woolen garments	<p>Machine drying knitted woolens is not recommended. Block to shape when wet and allow to air dry. Line dry blankets in shade on a breezy day over two lines. Pin edges together and straighten them. When partly dry, turn the blanket over, repin, and restraighten. When dry, brush nap.</p> <p>Dry as recommended for permanent press fabrics on page 11.</p> <p>If manufacturer recommends machine drying:</p> <ol style="list-style-type: none"> 1. Place one or two dry towels in the dryer and preheat 3-5 minutes on a high setting. This will dry blankets faster and help avoid pilling. 2. Put blanket in dryer with warm towels. Set control for 20 minutes. 3. Check after 10 minutes. Remove when still damp. Overdrying and long tumbling can cause shrinking and pilling. 4. Place blanket on flat surface or over two lines to finish drying. Gently stretch to original size and shape. 5. When completely dry, brush gently to raise nap. Press binding with cool iron if needed.
Curtains, slipcovers •Draperies, slipcovers	<p>Remove drapery weights and hooks before laundering. For slipcovers, replace while still slightly damp. They will dry to fit tightly.</p> <p>Dry only a few minutes.</p> <ol style="list-style-type: none"> 1. Leave room in dryer for load to fluff. 2. Remove from dryer while slightly damp. Do not overdry.
Diapers, baby clothes	<p>Wash and dry small items in a mesh bag or pillowcase for convenient handling.</p> <p>Remove diapers and cotton knit items while still slightly damp. They will feel softer, shrink less, and be easier to fold.</p>
Elastic items	<p>Remove from dryer while still slightly damp.</p>
Flame-retardant finishes	<p>Some items have been treated with a flame-retardant finish to improve their resistance to burning. Such items are clearly labeled. To retain flame-retardant qualities through continuous use and washing, clean and dry according to the manufacturer's instructions.</p>

ITEMS	DRYING INSTRUCTIONS
<p>Napped items</p> <ul style="list-style-type: none"> • Corduroy, velveteen 	<p>Dry separately or with similar colors to avoid lint transfer. Follow care label instructions.</p> <ol style="list-style-type: none"> 1. Remove from dryer while there is still a trace of moisture. 2. Smooth, reshape, and air dry before putting away.
<p>Quilted, down-filled items</p>	<p>Follow care label instructions.</p> <ol style="list-style-type: none"> 1. Dry one at a time. 2. Remove from dryer and shake or fluff the item during the drying cycle. 3. Smooth and reshape before putting away.
<p>Snowsuits, jackets</p> <ul style="list-style-type: none"> • Nylon or polyester 	<p>Check label for fiber content, then follow care label instructions.</p> <ol style="list-style-type: none"> 1. Dry garment for about 10 minutes. Remove and turn inside out. Dry for 10 more minutes. 2. Remove from dryer immediately and hang on a nonrusting hanger to finish drying. This will help eliminate wrinkles.
<p>Tinted, dyed, or noncolorfast items</p>	<p>Dry according to fabric, weight, and care label instructions. Wipe the dryer drum carefully to remove any dye or lint that can be transferred to other loads. See "Cleaning the dryer interior" on page 17.</p>
<p>Washable knits</p>	<p>Do not overdry knits. Overdrying can cause shrinking and static cling.</p> <ol style="list-style-type: none"> 1. Select cycle according to fabric and construction. 2. Turn synthetics and blends inside out when drying to avoid pilling. 3. Remove cotton and rayon knits while still slightly damp. Stretch into shape and lay flat to finish drying.



Using dryer fabric softeners

Dryer fabric softeners are recommended for reducing static cling and for softening fabrics. Always follow package instructions carefully.

- Put one fabric softener sheet on top of the load **before starting the dryer**. Do not add a fabric softener sheet **after** the cycle has started. Instant heat can cause the fabric softener to spot fabrics.

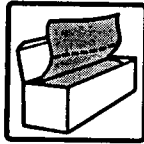

- Remove fabric softener stains by wetting the stains and rubbing them with liquid detergent or bar soap and rewash.
- Some fabric softeners can clog the lint screen and slow drying. Use fabric softeners labeled as dryer safe.

Saving energy

- Use an Automatic cycle to dry most loads.
- Dry only full loads without overdrying.
- Avoid overloading dryer, adding wet items to a partly dried load, or opening the door unnecessarily.
- Plan your laundry to dry one load after another. A warm dryer shortens drying time.
- Shorten drying times by exhausting dryer properly and cleaning exhaust duct and outside exhaust hood as needed.
 - Keep the lint screen clean.
 - Use your dryer in a room where room air temperature is above 45°F (7°C).
 - Sort loads by fabric weight and type.

Vacation care

1. Unplug power supply cord or turn off electrical power supply.
2. Clean lint screen.



Troubleshooting

Most laundering problems are easily solved if you understand the cause. Check the following list for laundry problems you may have and their possible causes. Also refer to the next page for a dryer checklist which can help you solve some simple problems without calling for service. If you still need help, see "Requesting Assistance or Service" on page 25.

Common laundry problems

PROBLEM	CAUSE
Greasy spots	<ul style="list-style-type: none">• Dryer fabric softener improperly used. See page 22.• Drying soiled items.
Lint	<ul style="list-style-type: none">• Full lint screen. (See page 16.)• Load not properly sorted.• Overdrying, especially synthetic fabrics that cause lint-attracting static electricity.• Load size too big or heavy.• Tissue or paper left in pockets.• Pilling (surface fuzz caused by normal wear and laundering) attracts lint.
Shrinking	<ul style="list-style-type: none">• Overdrying.• Fabric type and quality inappropriate for drying.• Dryer settings incorrect for fabric type.• Manufacturer's care label instructions not followed.
Slow drying	<ul style="list-style-type: none">• Full lint screen. (See page 16.)• Load too large and bulky to dry quickly.• Dryer located in room with temperature below 45°F (7°C).• Exhaust duct clogged, restricted, or too long.
Stains	<ul style="list-style-type: none">• Drying soiled items.• Dryer fabric softener improperly used. See manufacturer's directions.• Dryer interior stained. (See page 17 for cleaning procedures.)
Static electricity	<ul style="list-style-type: none">• Overdrying.• Dryer fabric softener improperly used. See manufacturer's directions.• Load includes synthetics, synthetic blends, permanent press, and knit fabrics that build up static electricity.
Wrinkling	<ul style="list-style-type: none">• Overloading.• Overdrying, especially permanent press and synthetic fabrics.• Clothes left in dryer at end of cycle.

Troubleshooting

Common dryer problems

Before calling for service, check these:

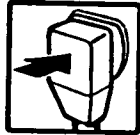

Is the power cord plugged in?

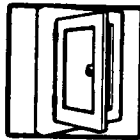

Have you blown a fuse or tripped the circuit breaker?

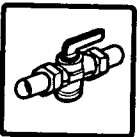

For gas dryers, are the valves open on the dryer and the supply line?

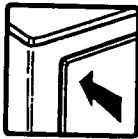

Is the dryer door firmly closed?

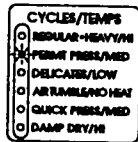

Have you selected a cycle?



Did you press START?

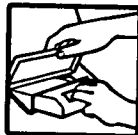

Is lint screen clogged with lint?

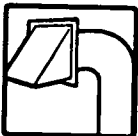

Is exhaust duct or outside exhaust hood clogged with lint?



Is the dryer making noise? Is there a thumping sound from the drum support rollers indicating dryer has not been used for awhile? Is the lint signal sounding?

If you still have problems, see "Requesting Assistance or Service" on page 25.

Requesting Assistance or Service

1. If you need assistance* ...

- Call KitchenAid Consumer Assistance Center:

1-800-422-1230

One of our trained consultants can instruct you in how to obtain satisfactory operation from your appliance or, if service is necessary, recommend a qualified service company in your area.

- If you prefer, write to:

Consumer Assistance Center
KitchenAid
2000 North M-63
Benton Harbor, MI 49022-2692

2. If you need service* ...

- Call your dealer or the repair service he recommends.
- All service should be handled locally by the dealer from whom you purchased the unit or an authorized KitchenAid servicer.
- If you are unable to obtain the name of a local authorized KitchenAid servicer, call our Consumer Assistance Center telephone number (see Step 1).

3. If you are not satisfied with the action taken:

- Contact the Major Appliance Consumer Action Panel (MACAP). MACAP is a group of independent consumer experts that voices consumer views at the highest levels of the major appliance industry.
- Contact MACAP only when the dealer, authorized servicer, and KitchenAid have failed to resolve your problem.
Major Appliance Consumer Action Panel
20 North Wacker Drive
Chicago, IL 60606
- MACAP will in turn inform us of your action.

To order an optional accessory, write:

KitchenAid
Parts Distribution Center
123 Koomler Drive
LaPorte, IN 46350
or call 1-800-422-1230

*When asking for help or service:

Please provide a detailed description of the problem, your appliance's complete model and serial numbers, and the purchase date. (See page 2.) This information will help us respond properly to your request.

Don't forget, KitchenAid offers a full line of quality home appliances.

Built-in Refrigerators

Trash Compactors

Ranges & Cooktops

Freestanding Refrigerators

Hot Water Dispensers

Microwave Ovens

50-Pound Ice Makers

Food Waste Disposers

Washers & Dryers

Dishwashers

Built-in Ovens

Mixers & Blenders

For more information on these appliances, or the one you have purchased, call our toll-free Consumer Assistance Center telephone number, **1-800-422-1230**.

KitchenAid®

Dryer

Warranty

LENGTH OF WARRANTY:	KITCHENAID WILL PAY FOR:	KITCHENAID WILL NOT PAY FOR:
ONE YEAR FULL WARRANTY FROM DATE OF PURCHASE.	Replacement parts and repair labor costs to correct defects in materials or workmanship. Service must be provided by an authorized KitchenAid servicing outlet.	A. Service calls to: <ol style="list-style-type: none"> 1. Correct the installation of the dryer. 2. Instruct you how to use the dryer. 3. Replace house fuses or correct house wiring. 4. Correct house plumbing. B. Repairs when dryer is used in other than normal home use. C. Damage resulting from accident, alteration, misuse, abuse, improper installation or installation not in accordance with local electrical or plumbing codes. D. Any labor costs during the limited warranties. E. Replacement parts or repair labor costs for units operated outside the United States. F. Pick up and delivery. This product is designed to be repaired in the home. G. Repairs to parts or systems caused by unauthorized modifications made to the appliance.
SECOND YEAR LIMITED WARRANTY FROM DATE OF PURCHASE.	Replacement parts to correct defects in materials or workmanship.	
SECOND THROUGH FIFTH YEAR LIMITED WARRANTY FROM DATE OF PURCHASE.	Replacement parts for any electrical element on electric models or any burner on gas models to correct defects in materials or workmanship. Replacement parts for the cabinet assembly should it rust through due to defects in materials or workmanship. Replacement parts for the "Gold Seal" motor to correct defects in materials or workmanship. For solid state touch control models, replacement parts for the solid state controls if defective in materials or workmanship.	
SECOND THROUGH TENTH YEAR LIMITED WARRANTY FROM DATE OF PURCHASE.	Replacement parts for the dryer drum if it rusts through due to defects in materials or workmanship.	

KITCHENAID DOES NOT ASSUME ANY RESPONSIBILITY FOR INCIDENTAL OR CONSEQUENTIAL DAMAGES. Some states do not allow the exclusion or limitation of incidental or consequential damages, so this exclusion or limitation may not apply to you. This warranty gives you specific legal rights and you may also have other rights which vary from state to state.

Outside the United States, a different warranty may apply. For details, please contact your authorized Whirlpool distributor or military exchange.

If you need service, first see the "Requesting Assistance or Service" section of this book. Additional help can be found by calling our Consumer Assistance Center, **1-800-422-1230**, from anywhere in the U.S.A.

KitchenAid
Benton Harbor, Michigan, U.S.A. 49022-2692

PART NO. 3392994

© 1995 KitchenAid

® Registered Trademark/TM Trademark of KitchenAid.

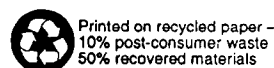

Printed in U.S.A.

Free Manuals Download Website

<http://myh66.com>

<http://usermanuals.us>

<http://www.somanuals.com>

<http://www.4manuals.cc>

<http://www.manual-lib.com>

<http://www.404manual.com>

<http://www.luxmanual.com>

<http://aubethermostatmanual.com>

Golf course search by state

<http://golfingnear.com>

Email search by domain

<http://emailbydomain.com>

Auto manuals search

<http://auto.somanuals.com>

TV manuals search

<http://tv.somanuals.com>