

# KSCX 3610

## Instructions for use

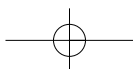

FOR THE WAY IT'S MADE.®

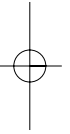
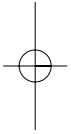

<b>1 Product description</b>	<b>4</b>
<b>2 Important notes</b>	<b>8</b>
<b>Important information for the correct disposal of the product in accordance with EC directive 2002/96/EC</b>	<b>8</b>
<b>Building-in</b>	<b>9</b>
<b>3 Before first use</b>	<b>11</b>
<b>4 Using for the first time</b>	<b>12</b>
<b>5 Preparing coffee (using coffee beans)</b>	<b>13</b>
<b>6 Changing the quantity of coffee in the cup</b>	<b>15</b>
<b>7 Regulating the coffee mill</b>	<b>15</b>
<b>8 Preparing espresso coffee using ground coffee (instead of beans)</b>	<b>16</b>
<b>9 Hot water delivery</b>	<b>17</b>
<b>10 Preparing cappuccinos (using steam)</b>	<b>17</b>
<b>11 Cleaning and maintenance</b>	<b>18</b>
<b>12 Changing and setting the menu parameters</b>	<b>20</b>
<b>13 Changing the language</b>	<b>22</b>
<b>14 Meaning of messages and what to do</b>	<b>23</b>
<b>15 Problems that can be resolved before calling the Customer Care Centre</b>	<b>24</b>
<b>After-Sales Service</b>	<b>26</b>

## 1 Product description

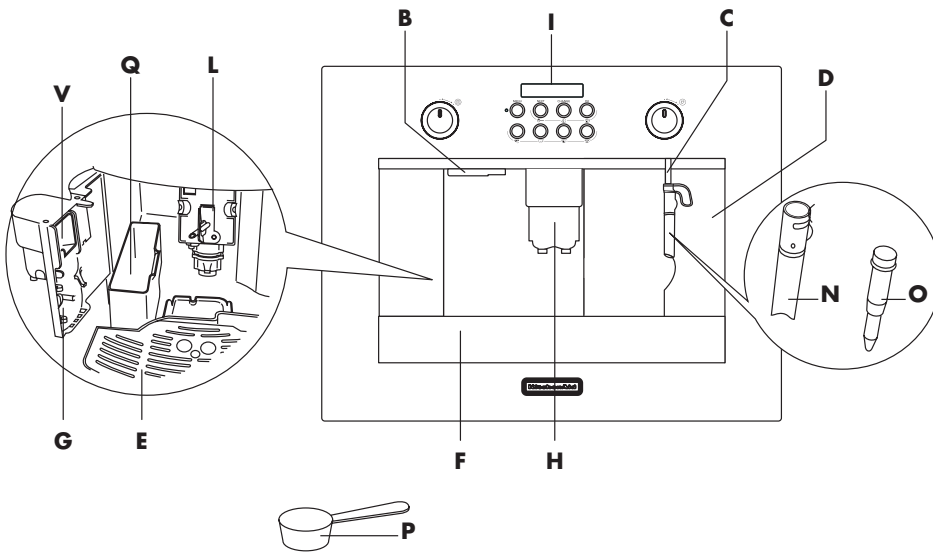

- A.** Main ON/OFF switch
- B.** Lights
- C.** Steam spout
- D.** Water tank (removable)
- E.** Cup tray
- F.** Drip tray (removable)
- G.** Service door
- H.** Coffee spout (adjustable in height)
- I.** Control panel
- J.** Bean container lid
- K.** Central ground coffee lid
- L.** Infuser
- M.** Power cable
- N.** Cappuccino maker (removable)
- O.** Cappuccino maker nozzle (removable)
- P.** Measure for pre-ground coffee
- Q.** Coffee grounds container (removable)
- R.** Grinding coarseness regulator
- S.** Coffee beans container
- T.** Compartment for measure
- U.** Ground coffee funnel
- V.** Mobile drawer
- W.** Accessories holder

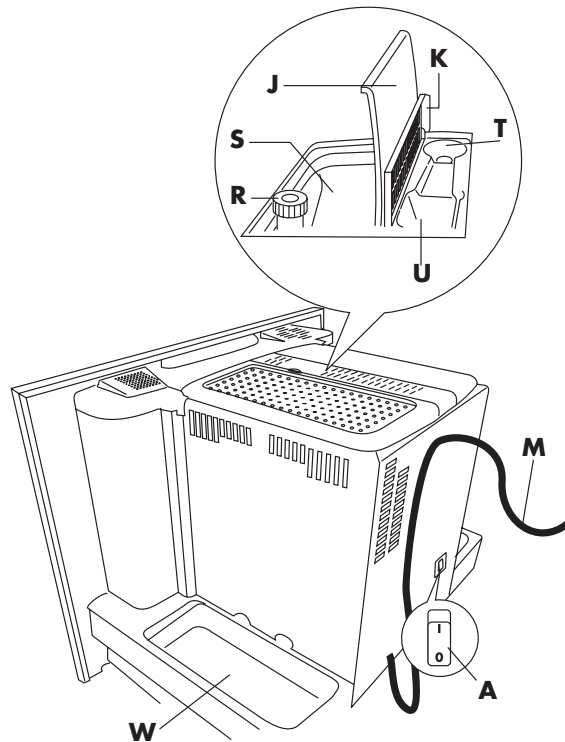

## 1 Product description

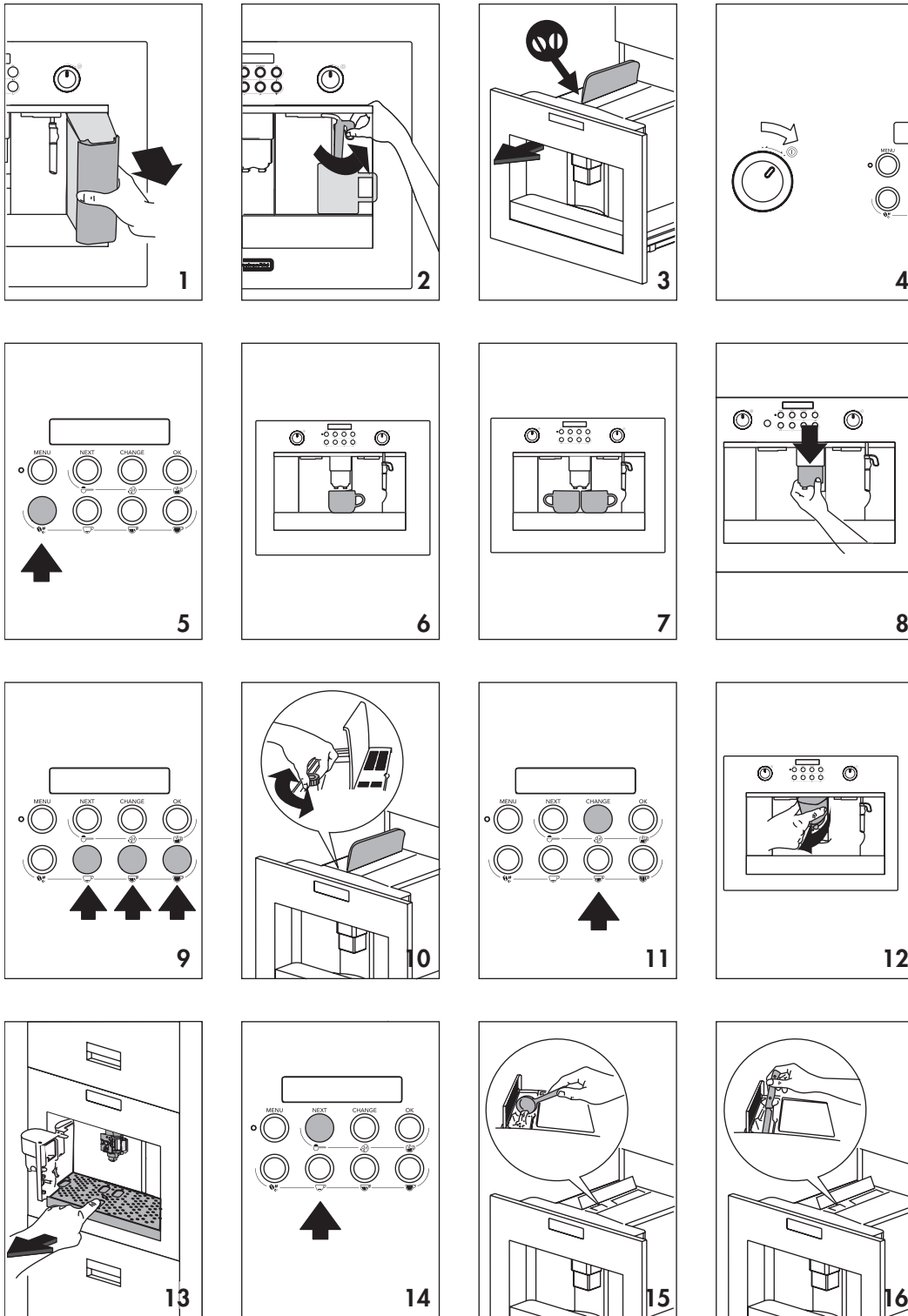

## 1 Product description

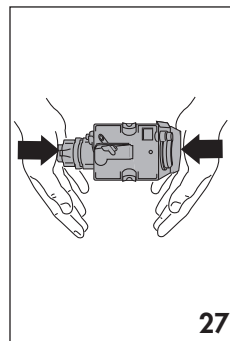
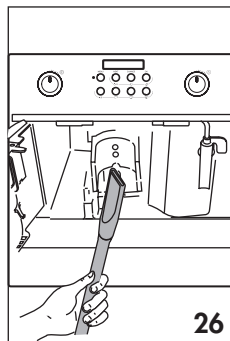
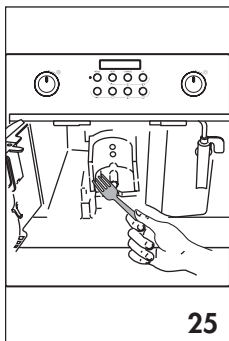
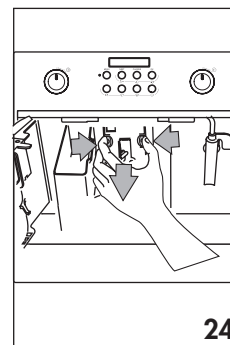
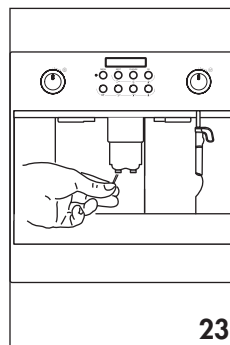
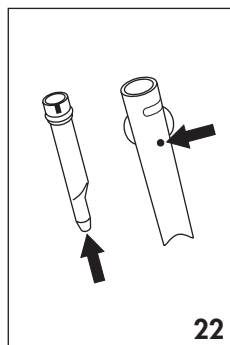
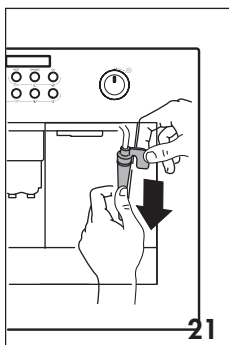
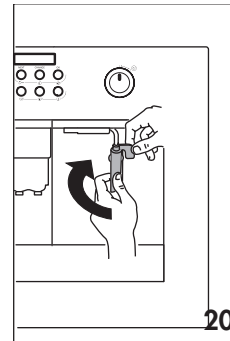
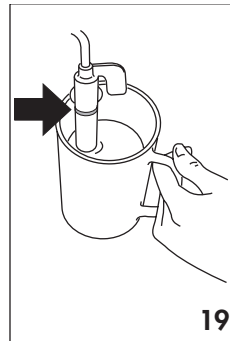
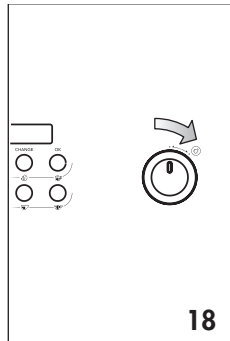
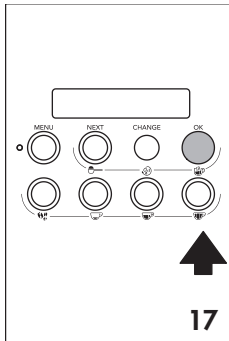

## 1 Product description

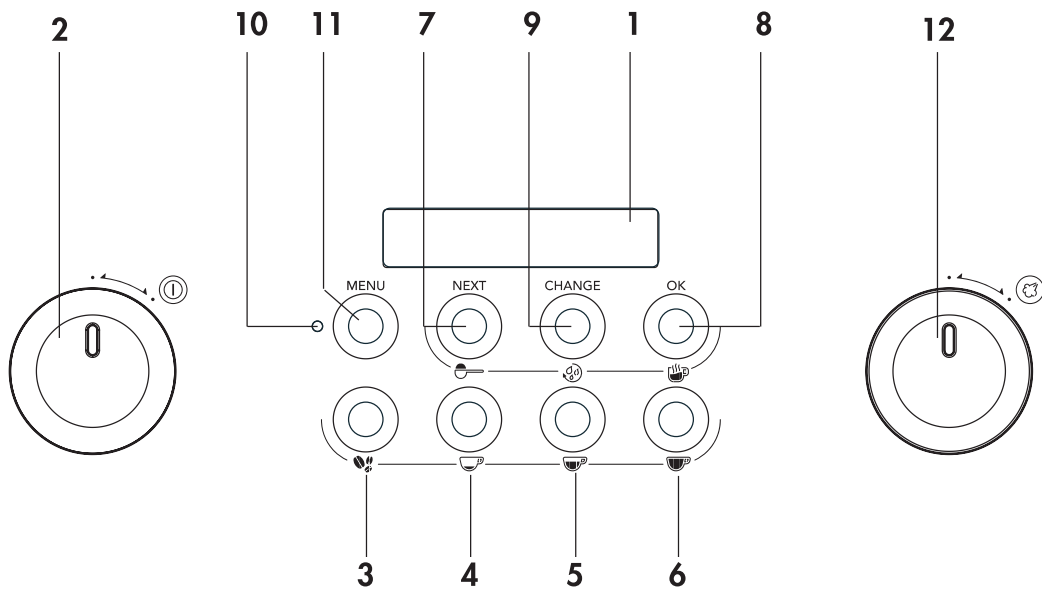

### Control Panel

1. Display
2. Appliance ON/OFF knob
3. Coffee taste selection button
4. One or two cups short coffee button
5. One or two cups standard coffee button
6. One or two cups long coffee button
7. Button to select ground coffee or, if the MENU light is on, to display the next parameter on the menu
8. Button to select hot water or OK to confirm
9. Button to rinse the appliance or, if the MENU light is on, to change the menu parameters
10. Button to activate or deactivate menu parameter setting mode (MENU)
11. MENU light
12. Steam knob

To use the knobs, turn them clockwise...

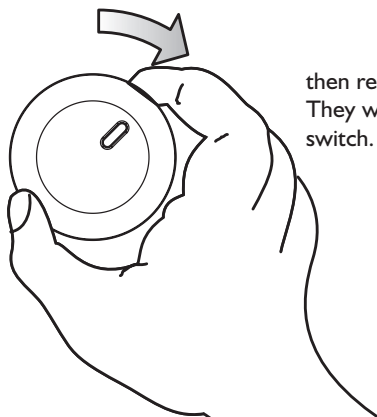

then release. They work just like a switch.

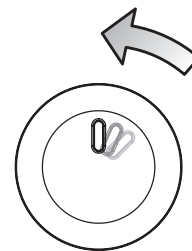

## 2 Important notes

READ THESE INSTRUCTIONS CAREFULLY AND KEEP FOR FUTURE CONSULTATION!

- This appliance is designed to "make espresso coffee" and "heat drinks". Use with care to avoid scalds from the water and steam jets or through incorrect use.
- This appliance is intended for domestic use only. Any other use is considered improper and thus dangerous.
- Do not hang to the appliance when it is extracted.
- The manufacturer is not liable for damage caused by improper, incorrect or unreasonable use of the appliance.
- When using the appliance, do not touch the hot surfaces. Use the knobs or handles.
- Never touch the appliance with any wet part of the body or operate it with bare feet.
- The appliance is not intended for use by persons (including children) with reduced physical, sensory or mental capabilities, or lack of experience and knowledge, unless they have been given supervision or instruction concerning use of the appliance by a person responsible for their safety. Children should be supervised to ensure that they do not play with the appliance.
- In the event of failure or malfunction, unplug the appliance from the mains and do not tamper with it in any way. If it requires repair, contact an authorised service centre only and ask for original spare parts to be used. Failure to respect the above could reduce the safety of the appliance.
- This appliance may be installed above a conventional built oven provided it is fitted with a cooling blower on the top side. The nominal power of the oven shall not be more than 3Kw.
- Do not rest objects containing liquids, inflammable or corrosive materials; use the accessories holder to contain coffee accessories (for example coffee measure). Do not rest big objects that may block the movement of the appliance or unstable objects.
- Avoid exposing the appliance to atmospheric agents.
- The parts which could come into contact with coffee or milk conform to the provisions of the EEC directive 1935/2004 relating to materials suitable for contact with foodstuffs.
- This appliance conforms to EC directive 2004/108/EC on Electromagnetic Compatibility (EMC).

## Important information for the correct disposal of the product in accordance with EC directive 2002/96/EC

This appliance is marked according to the European directive 2002/96/EC on Waste Electrical and Electronic Equipment (WEEE).

By ensuring this product is disposed of correctly, you will help prevent potential negative consequences for the environment and human health, which could otherwise be caused by inappropriate waste handling of this product.



The symbol  on the product, or on the documents accompanying the product, indicates that this appliance may not be treated as household waste. Instead it shall be handed over to the applicable collection point for the recycling of electrical and electronic equipment.

Disposal must be carried out in accordance with local environmental regulations for waste disposal. For more detailed information about treatment, recovery and recycling of this product, please contact your local city office, your household waste disposal service or the shop where you purchased the product.





## Building-in

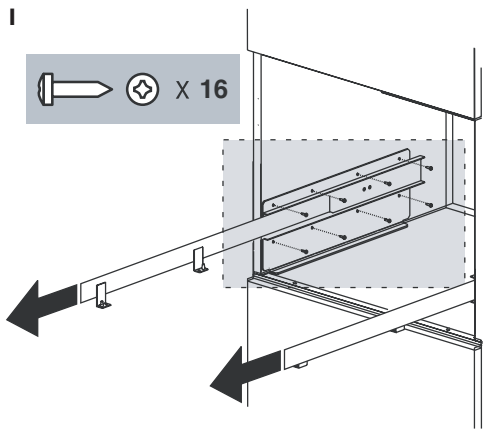

Lean the bars to the surface of the furniture. Fix the bars with the screws provided; then completely extract the two bars. In case of installation above a "warmer drawer", use the top of the latter as a reference for the coffee maker runners. In this case, there will be no support surface.

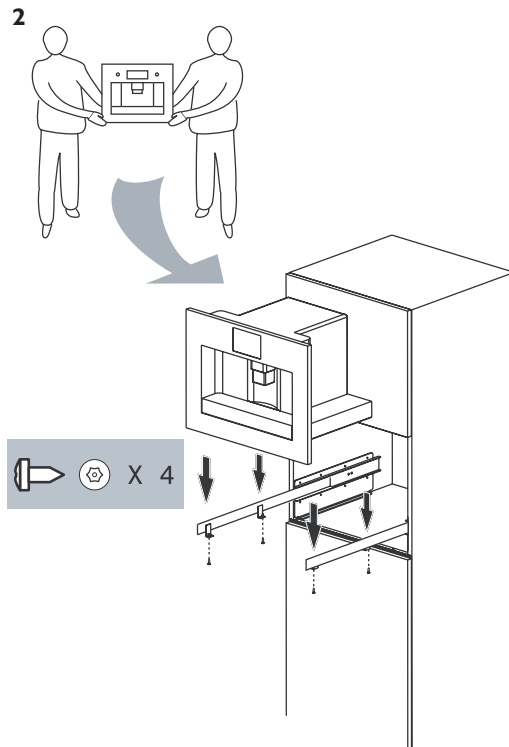

Put the appliance on its housing and fasten it with the screws.

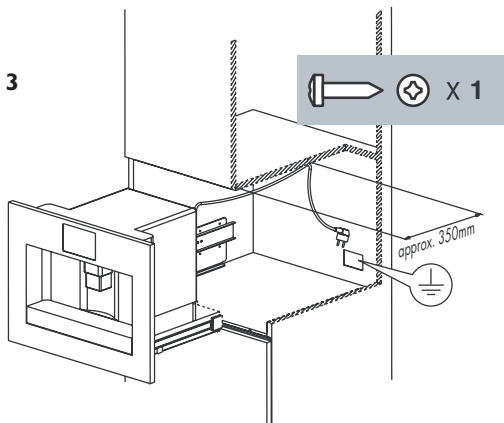

Fix the power cord with the special clip, to avoid the cord entangling when extracting or inserting the appliance. The power cord must be long enough to allow the extraction of the appliance for refilling the coffee bean container.

**Regulations require that the appliance must be earthed. The electrical connection must be made by a qualified electrician in compliance with the manufacturer's instructions and applicable local regulations.**

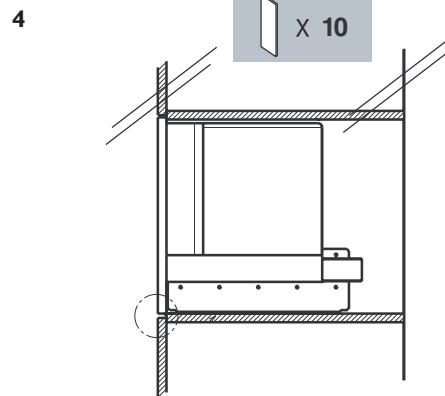

To align the appliance correctly, put the spacers under the bar's support.

### 3 Before first use

- After removing the packaging, make sure the product is complete and undamaged. If in doubt, do not use the appliance and contact a qualified professional.
- Installation must be carried out by a qualified technician and in compliance with current regulations.
- Packing elements (plastic bags, polystyrene etc) must not be left within reach of children as they may represent a hazard.
- Never install the appliance in environments where the temperature may reach 0°C or lower (the appliance may be damaged if the water freezes).
- Make sure the mains voltage corresponds to the voltage indicated on the appliance rating plate. Connect the appliance to an efficiently earthed socket with a minimum current rating of 10A only. The manufacturer may not be considered liable for possible incidents caused by the failure to adequately earth the mains.
- If the power socket does not match the plug on the appliance, have the socket replaced with a suitable type by a qualified professional.
- Observance of safety directives requires that a multi pole switch with a minimum contact gap of 3 mm be used for the installation.
- Do not use multiple plug adapters or extension leads.
- The power cable on this appliance must not be replaced by the user as this operation requires the use of special tools. If the cable is damaged or requires replacing, contact an authorised service centre only to avoid all risks.  
For the electrical connection use a **H05 VV-F** type cable as indicated in the table below:

Conductors	Amount x Size
220-240 V ~ + $\perp$ ~	3 x 1.0 mm <sup>2</sup>

To learn how to operate the appliance correctly, when you use it for the first time, follow the step-by-step instructions given in the following chapters.

## 4 Using for the first time

The first time you turn on the appliance and every time that it is plugged in, when you turn the main ON/OFF knob clockwise (A), the appliance makes a SELF-DIAGNOSIS operation and then turns itself off. To turn it on again, rotate the ON/OFF knob (2) clockwise on the control panel.

1. The first time you use the appliance, select the language.  
Press the main ON/OFF switch on the rear side of the appliance; the lights on the front side and the display illuminate. Wait for the appliance to display:

PRESS OK TO INSTALL ENGLISH

Press the OK button for at least 3 seconds until the appliance displays:

ENGLISH INSTALLED

The appliance then displays the setting message in English.

2. After a few seconds, the appliance displays:

FILL TANK

To fill, remove the tank (fig. 1), rinse and fill with fresh water. Never exceed the MAX line. (When removing the tank, the cappuccino maker must always be positioned towards the centre of the appliance, otherwise the tank cannot be removed).

Put the tank back and **push as far as it will go**.

Move the cappuccino maker outwards (fig. 2) and place a cup underneath it.

3. The appliance now displays:

PRESS OK

Press the OK button. After a few seconds, a little water runs out of the cappuccino maker. When the cup contains about 30cc of water, the water stops running and it switches off.

4. The appliance now displays:

TURNING OFF PLEASE WAIT ...

and it goes off.

5. Extract the appliance by pulling it outwards taking care to use the special handles, open the lid and the container with coffee beans (fig. 3), then close the lid and push the appliance inwards the appliance.

**IMPORTANT:** to prevent malfunction, never fill with ground coffee, freeze dried coffee, caramelised beans or anything else which could damage the appliance.

6. Turn the ON/OFF knob (fig. 4), The appliance displays:

HEATING UP PLEASE WAIT ...

to indicate that preheating is underway.

7. When preheating is complete, the appliance displays:

RINSING COMPLETE PLEASE WAIT ...





and performs an automatic rinse cycle (a little hot water runs out of the spouts and is collected in the drip tray beneath).

**Tip:** if you want to make a short coffee (less than 60 cc), to make it hotter, fill the cup with this hot rinsing water first. Leave it for a few seconds then empty it to warm the cup.

8. The appliance now displays the ready message:

READY STANDARD TASTE

## 5 Preparing coffee (using coffee beans)

1. The appliance is preset to make coffee with a standard strength. You can also choose coffee with different strengths. To choose the required strength, press the  button (fig.5): and the selected coffee strength will be displayed.
2. Place 1 cup under the spouts to make 1 coffee (fig. 6) or 2 cups for 2 coffees (fig. 7). For a creamier coffee, lower the spouts to bring them as close to the cups as possible (fig. 8).
3. Press the  button to make a short coffee, the  button for a standard coffee and the  button for a long coffee (fig. 9).

**To make 2 coffees, press the button twice (within 2 seconds).**

**To change the quantity of coffee delivered automatically into the cup, follow the instructions in chapter 6.**

(The appliance now grinds the beans and starts running off the coffee into the cup. Once the desired quantity has been reached, the appliance automatically stops delivering the coffee and ejects the grounds into the special container).

4. After a few seconds, the ready message is displayed again and you can make another coffee.
5. To turn the appliance off, turn the main knob to the OFF position.  
Before switching off, the appliance performs an automatic rinse cycle (a little hot water runs out from the spouts and is collected in the drip tray beneath). Take care to avoid scalds.  
**Once switched off, the lights will not shut off immediately and the cooling span motor operates to avoid condensation in the housing. After about 30 minutes, the appliance switches completely off.**

**NOTE 1:** If the coffee is delivered a drop at a time or not at all, turn the grinding coarseness regulator (fig. 10) one click clockwise (see chapter 7).

Turn one click at a time until the coffee is delivered satisfactorily.



**NOTE 2:** If the coffee is delivered too fast and is not creamy enough, turn the grinding coarseness regulator (fig. 10) one click anticlockwise (see chapter 7).

Avoid turning the grinding coarseness regulator excessively otherwise when you select 2 cups, the coffee may run out in drips.

**NOTE 3:** Tips to make hotter coffee:

- **When you turn the appliance on**, if you want to make a short coffee (less than 60 cc), use the hot rinse-through water to preheat the cups.  
If **2/3 minutes have passed**, since you last made coffee, before making coffee again you must preheat the infuser by pressing the  button (fig. 11).  
Run off the water into the underlying drip tray or alternatively use this water to fill (and then empty) the cup to be used for the coffee, so as to preheat it.
- Unless preheated, do not use cups that are too thick, as they will absorb too much heat.
- Use cups that have been preheated by rinsing them with hot water or by leaving them for at least 20 minutes on the cup warmer tray on top of the appliance with the appliance on.

**NOTE 4:** while the appliance is making the coffee, **delivery can be stopped at any time** by pressing the ,  or  button as previously selected.

**NOTE 5:** as soon as delivery is complete, to **increase the quantity** of coffee, simply press and hold the ,  or  button as previously selected, until the desired quantity is reached (this operation must be performed within 3 seconds from when coffee delivery from the spouts ceases).

## 5 Preparing coffee (using coffee beans)

**NOTE 6:** when the appliance displays:

FILL TANK

the water tank must be refilled or the appliance will not make coffee.  
(It is normal for there to be a little water left in the tank when the message is displayed).

**NOTE 7:** the appliance counts the number of coffees made.  
Every 14 single coffees (or 7 doubles) the appliance displays:

EMPTY GROUNDS CONTAINER

indicating that the grounds container is full and must be emptied and cleaned.  
Until the grounds container has been cleaned, the appliance continues to display the message and cannot make coffee.

To clean, open the service door at the front by pulling the coffee spout (fig. 12), remove the drip tray (fig. 13), empty and clean. *When proceeding, **always completely extract the drip tray**, to avoid it falling when removing the grounds container.*

Empty the grounds container and clean thoroughly, making sure all residues deposited on the bottom are removed.

**IMPORTANT:** when removing the drip tray, the grounds container **MUST** be emptied, even if it is not completely full. If this is not done, when next making coffee the grounds in the container may exceed the maximum level and block the appliance.

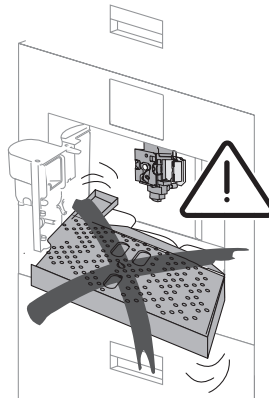

**NOTE 8:** while the appliance is running off coffee, **never remove the water tank**. If it is removed, the appliance will not be able to make the coffee.

**When using the appliance for the first time, 4-5 cups of coffee need to be made before the appliance starts to give satisfying results.**

**If the appliance malfunctions,** do not contact the Customer Care Centre straight away. The problem can almost always be resolved by following the instructions indicated in chapters 14 and 15. If this is not the case, or for further explanations, contact the Customer Care Centre by calling the number listed on page 2 of the enclosed sheet.  
If your country is not listed on the sheet, call the number indicated on the warranty.

## 6 Changing the quantity of coffee in the cup

The appliance is factory preset to automatically deliver the following quantities of coffee:

- short (when the ☕ button is pressed);
- standard (when the ☕ button is pressed);
- long (when the ☕ button is pressed);

To change these quantities, proceed as follows:

- press the button corresponding to the quantity you want to change (☕, ☕ or ☕) for at least 8 seconds until the message "PROGRAM QUANTITY" is displayed;
- when the coffee in the cup reaches the required level, press the same button again to memorise the new amount.

## 7 Regulating the coffee mill

However, after making the first few coffees, if you find that coffee delivery is either too fast or too slow (in drips), the grinding coarseness regulator can be adjusted (fig. 10).

Turning it 1 click (1 number) clockwise speeds up coffee delivery (without drips).

Turning it 1 click anticlockwise slows down delivery giving a creamier appearance to the coffee.

These adjustments will only be evident after at least 2 cups of coffee have been run off.

The grinding coarseness regulator must only be turned when the coffee mill is on.

*Turn anticlockwise to obtain finer ground coffee, slower delivery and a creamier appearance.*

*Turn clockwise for coarser ground coffee and faster delivery (not a drop at a time).*

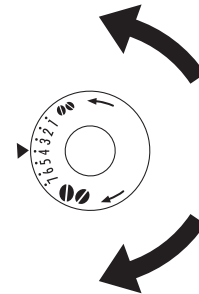



(Coffee has been used to factory test the appliance and it is therefore completely normal for there to be traces of coffee in the mill. This appliance is however guaranteed to be new).

## 8 Preparing espresso coffee using ground coffee (instead of beans)

- Press the  (fig. 14) button to select the ground coffee function. This disables the coffee mill function.

The appliance displays

READY PRE-GROUND

- Extract the appliance by pulling it using the special handles (fig. 3).
- Lift the central lid, place one level measure of ground coffee in the funnel (see fig. 15). Close the lid, push the appliance to replace it and proceed as described in chapter 5. Note: You can make just one coffee at a time by pressing the ,  or  button once only.

**NOTE 1:** Never add the ground coffee when the appliance is off to avoid it being dispersed inside the appliance.

**NOTE 2:** Never add more than one level measured scoop, otherwise either the appliance will not make the coffee, the ground coffee will be lost inside the appliance, dirtying it, or the coffee will run off in drips and the message "GROUND TOO FINE ADJUST GRINDER AND PRESS OK" will be displayed. A little water comes out from the steam spout.



**NOTE 3:** When dosing the quantity of coffee to be added, use the measure supplied only.

**NOTE 4:** Use ground coffee for espresso coffee makers only. Do not use coffee beans, freeze-dried coffee or other materials that could damage the appliance.

**NOTE 5:** If the funnel blocks due to moisture inside the appliance or if more than one measuring scoop of pre-ground coffee has been used, use a knife to push the coffee down (Fig. 16), then remove and clean the infuser and appliance as described in chapter 11.2 "Cleaning the infuser".



- Once the coffee has been delivered, to go back to making coffee using beans, deactivate the ground coffee function by pressing the  button again (the light goes off and the coffee mill is enabled for operation again).



## 9 Hot water delivery

- Always make sure the appliance is ready.
- Turn the cappuccino maker towards the outside of the appliance and place a container under it (fig. 2).
- Press the  (fig. 17). The appliance displays:

HOT WATER PRESS OK

- Press the OK /  button again (fig. 17) for hot water.
- Hot water runs off from the cappuccino maker and starts to fill the container underneath. You should not run off hot water for more than 2 minutes at a time. To interrupt hot water delivery, press the  button again (fig. 17) and place the cappuccino maker in the original position near the centre of the appliance.

**Note:** if you accidentally push the OK /  button, push any other button to abort the function or wait until the appliance automatically turns back to the main menu.

## 10 Preparing cappuccinos (using steam)

- Move the cappuccino maker outwards (fig. 2).
- Place an empty container under the cappuccino maker. Turn the steam knob (fig. 18). The appliance displays:

STEAM PRESS OK

- Press the OK button (fig. 17) for steam.  
Allow the steam mixed with water to run off for a few seconds until steam only is given off.
- To interrupt steam delivery, turn the steam knob counter clockwise the steam knob (fig. 18).  
**Note:** if you accidentally turn the steam knob, push any button, except the OK button, to abort the function or wait until the appliance automatically turns back to the main menu.
- Empty the container then fill it with about 100 grams of milk for each cappuccino to be prepared. In choosing the size of the container, bear in mind that the milk doubles or triples in volume. You are recommended to use semi-skimmed milk at refrigerator temperature.
- Dip the cappuccino maker into the milk (fig. 2), taking care not to immerse the raised line on the cappuccino maker (indicated by the arrow in fig. 19). Press the steam button (beware of burns). Steam is discharged from the cappuccino maker, giving the milk a creamy frothy appearance.  
To obtain a creamier froth, dip the cappuccino maker into the milk and rotate the container with slow movements from the bottom upwards. (You should not discharge steam for more than two minutes at a time).
- Once the required temperature is reached, interrupt steam delivery by pressing the steam button (fig. 18). Prepare the coffee as described above, using large enough cups, then fill with the frothed milk prepared previously. The cappuccino is ready. Sweeten to taste and, if desired, sprinkle the froth with a little cocoa powder.

**IMPORTANT:** always clean the cappuccino maker immediately after use. Proceed as follows:

- Discharge a little steam for a few seconds by pressing the steam button. This empties any milk left inside the steam spout.  
**IMPORTANT:** to guarantee hygiene, you are recommended to follow this procedure each time you make cappuccino to avoid milk stagnating in the milk circuit.

## 10 Preparing cappuccinos (using steam)

- Press the steam button.
- Wait a couple of minutes for the cappuccino maker to cool down then with one hand hold the cappuccino spout handle firm and with the other unscrew the cappuccino maker itself by rotating clockwise and extracting downwards (fig. 20).
- Remove the nozzle from the steam spout by pulling it downwards (fig. 21).
- Carefully wash the cappuccino maker and steam nozzle in warm water.
- Make sure the two holes shown in fig. 22 are not blocked. If necessary, clean with a pin.
- Replace the steam nozzle by inserting it and vigorously turning it upwards into the steam spout.
- Replace the cappuccino maker by pushing it upwards and turning it counter-clockwise.

## 11 Cleaning and maintenance

Before performing any cleaning operations, leave the appliance to cool down, switch off the main switch and unplug from the mains socket.

Do not use solvents or abrasive cleaning products to clean the appliance. A soft damp cloth will suffice. NEVER wash ANY of the components of the appliance in a dishwasher.

### 11.1 Cleaning the coffee maker

Clean the grounds container (as described in chapter 5, note 7) whenever it requires emptying.

The water tank should also be cleaned regularly.

The drip tray is fitted with a level indicator (red) showing the level of water it contains.

When the indicator starts to become visible (a few millimetres under the drip tray), the drip tray must be emptied and cleaned.

Check that the holes in the coffee spout are not blocked. To unblock them, scrape the dry coffee residues away with a needle (fig. 23).

### 11.2 Cleaning the infuser

The infuser must be cleaned regularly to avoid the build-up of coffee encrustations which could cause malfunction.

Proceed as follows:

- turn the appliance off by rotating the ① knob counter-clockwise (fig. 4) (do not switch off the main switch or unplug) and wait for the display to go off;
- open the service door (fig. 12);
- remove the drip tray and the grounds container (fig. 13) and clean;
- press the two red release buttons on the infuser sideways and towards the centre (fig. 24) and pull it out;
- **IMPORTANT: THE INFUSER CAN ONLY BE REMOVED WHEN THE APPLIANCE IS OFF. ATTEMPTING TO REMOVE THE INFUSER WITH THE APPLIANCE ON MAY CAUSE SERIOUS DAMAGE.**

## 11 Cleaning and maintenance

- Wash the infuser under running water, without using detergents. Never wash the infuser in the dishwasher;
- clean the inside of the appliance thoroughly. To remove coffee encrustations from the inside of the appliance, scrape with a plastic or wooden fork (fig. 25) then vacuum up the residues with a vacuum cleaner (fig. 26);
- replace the infuser by sliding it onto the supports and pin at the bottom, then push the PUSH symbol fully in until it clicks into place.

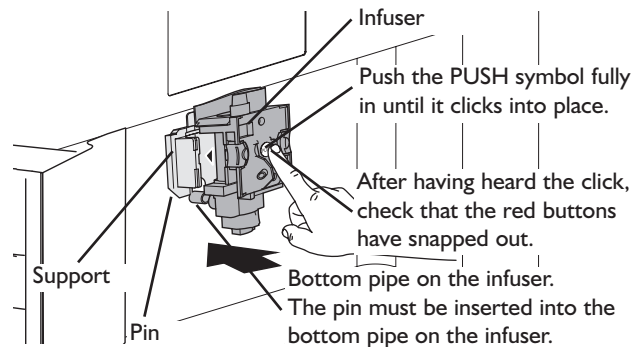

Check that the two red buttons have snapped out, otherwise the door cannot be closed.

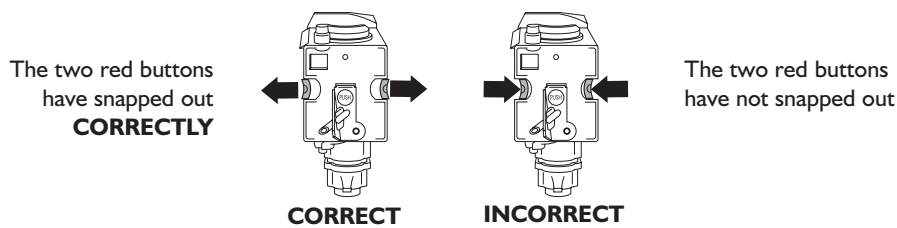

**NOTE 1:** If the infuser is not inserted correctly until it clicks into place and the two red buttons have not snapped out, the service door cannot be closed.

**NOTE 2:** If it is hard to insert the infuser, before inserting it squeeze it to the right size by pressing it forcefully from the top and bottom simultaneously, as shown in figure 27.

**NOTE 3:** If it is still hard to insert the infuser, leave it out of the appliance, close the service door, unplug from the mains then plug in again.

Wait for all the lights to go off, then open the door and replace the infuser.

- replace the drip tray, complete with the grounds container;
- close the service door.

## 12 Changing and setting the menu parameters

The following menu parameters and functions can be changed by the user:

- Clock
- Auto-start time
- Descaling process
- Coffee temperature
- Length of time the appliance remains on
- Water hardness Factory default values

### 12.1 Setting the clock

To set the clock, proceed as follows:

- Press the **MENU** (the light over the button comes on) then press the **NEXT** button repeatedly until the appliance displays

CLOCK 00:00

- Press the **CHANGE** button to set the clock. (If you hold the **CHANGE**, button down, the time is changed rapidly).
- Press the **OK** button to confirm the value;
- Press the **MENU** button to exit programming mode or **NEXT** to change other parameters.

**When the appliance is in stand-by, you can see the hour by pressing any one of the buttons (except the ON/OFF button).**

### 12.2 Setting auto-start time

This enables you to set automatic start times.

- Make sure the clock on the appliance is set as described above.
- Press the **MENU** button then press the **NEXT** button repeatedly until the appliance displays:

START TIME 00:00

- Press the **CHANGE** button to set the auto-start time. (If you hold the **CHANGE**, button down, the time is changed rapidly).
- Press the **OK** button to confirm the value,
- Press **NEXT** once and the appliance displays the message:

AUTO-START NO

Press the **CHANGE** button to modify the function (the appliance displays AUTO-START YES);

- Press the **OK** button to activate auto-start;
- Press the **MENU** button to exit programming mode or the **NEXT** button to change other parameters.

### 12.3 Descaling

Over time, the continuous heating up of the water used to make the coffee leads to lime scale building up in the inner circuits of the appliance.

When the appliance displays the message:

DESCALE

you should perform the descale cycle.

Proceed as follows:

- make sure the appliance is ready.
- press the **MENU** button (the light over the button comes on) then press the **NEXT** button repeatedly until the appliance displays:

DESCALE NO

- Press **CHANGE** and the appliance displays the message:

DESCALE YES

- Press the **OK** button to start the descale programme.

## 12 Changing and setting the menu parameters

- Empty the tank and pour in the contents of one bottle (125 ml) of DURGOL descaler plus one litre of water.

For subsequent descaling operations, descaling solution can be purchased from authorised technical service centres.

*NB: Make sure splashes of descaler do not fall onto surfaces sensitive to acid such as marble, limestone and glaze.*

- Place a container with a minimum capacity of 1.5 litres under the cappuccino maker (fig. 2);
- The descaling solution will run out of the cappuccino maker and start to fill the container underneath
- The descale programme automatically performs a series of run offs and pauses to remove lime scale deposits from inside the coffee maker.
- After about 30 minutes, the appliance displays:

RINSING FILL WATER TANK

The appliance must now be rinsed through to eliminate residues of descaling solution from inside the appliance. Proceed as follows:

- Remove the water tank, rinse and fill with clean water.
- Reposition the tank: the appliance display RINSING PRESS OK.
- Empty the collection container (under the cappuccino maker) full of liquid and then put it back under the cappuccino maker.
- Press the OK button (fig. 17).

Hot water is run off from the cappuccino maker into the container below and the appliance displays:

RINSING

- When the water tank is empty, the appliance displays the message:
- RINSE COMPLETE PRESS OK BUTTON
- Press the OK button (fig. 17) and refill the water tank with clean water. The descale programme is now terminated and the appliance is ready to make coffee again.

**NOTE:** if the descaling cycle is interrupted before completion, the appliance continues to display the descale message and the programme must be started again from the beginning.

**IMPORTANT:** FAILURE TO DESCALE THE APPLIANCE REGULARLY INVALIDATES THE GUARANTEE.

### 12.4 Changing coffee temperature

To change the temperature of the coffee, proceed as follows:

- Press the CHANGE button (the light over the button comes on) then press the NEXT button repeatedly until the appliance displays:

TEMPERATURE MEDIUM

- Press the CHANGE button until the appliance displays the required coffee temperature
- Press the OK button to confirm the temperature selected;
- Press the MENU button to exit programming mode or NEXT to change other parameters.

### 12.5 Changing the length of time the appliance remains on

The appliance is factory preset to go off automatically one hour after the last coffee has been made.

The number of hours the appliance remains on can be increased as follows:

- Press the MENU button (the light over the button comes on) then press the NEXT button repeatedly until the appliance displays:

OFF AFTER 1 HOUR

- Press the CHANGE button to change the number of hours the appliance remains on
- Press the OK button to confirm the value;
- Press the MENU button to exit programming mode or NEXT to change other parameters.

## 12 Changing and setting the menu parameters

### 12.6 Setting water hardness

The appliance is preset to display the descale message after a set period of time, based on a set water hardness. You can make descaling less frequent by programming the appliance based on the actual lime content in the water used. Proceed as follows:

- Remove the "Total Hardness Test" strip from its packaging then dip it fully in the water for a few seconds, Remove it and wait around 30 seconds (until it changes colour and a number of red dots are formed);
- Turn the appliance on by pressing the  button (fig. 4).
- Press the MENU button then press the NEXT button repeatedly until the appliance displays:

WATER HARDNESS 4

- Press the CHANGE button repeatedly until the number coincides with the number of red squares on the test strip (for example, if there are 3 red squares on the test strip, press the button until WATER HARDNESS 3 is displayed).
- Press the OK button to confirm the value. The coffee maker is now programmed to provide the descaling warning when necessary, based on the actual hardness of the water.

### 12.7 Resetting factory default settings

If you change the original values, the factory default values can be reset as follows:

- Press the MENU button then press the NEXT button repeatedly until the appliance displays:

RESET TO DEFAULT NO

- Press the CHANGE button and the appliance displays "RESET TO DEFAULT YES";
- Press the OK button to reset the factory default values;
- Press the MENU button to exit programming mode or NEXT to change other parameters.

## 13 Changing the language

To change the language, proceed as follows:

- Press the CHANGE button for at least 5 seconds until the appliance displays:

PRESS OK TO INSTALL ENGLISH





and press the OK button for at least 3 seconds to confirm. The appliance then displays the setting message in English.

## 14 Meaning of messages and what to do

MESSAGE	MEANING	WHAT TO DO
FILL TANK	<ul style="list-style-type: none"> <li>The water tank is empty or is positioned incorrectly.</li> <li>The tank is dirty or encrusted with lime scale.</li> </ul>	<ul style="list-style-type: none"> <li>Fill the water tank as described in chapter 5, note 6 and insert it fully.</li> <li>Rinse or descale the tank.</li> </ul>
GROUND TOO FINE ADJUST MILL AND PRESS THE OK BUTTON	<ul style="list-style-type: none"> <li>The appliance cannot make coffee.</li> <li>The coffee runs off too slowly.</li> </ul>	<ul style="list-style-type: none"> <li>Press the <b>OK</b> button (fig. 17).</li> <li>Turn the grinding regulator (fig. 10) one click clockwise (see chapter 7).</li> </ul>
EMPTY GROUNDS CONTAINER	<ul style="list-style-type: none"> <li>The grounds container is full.</li> </ul>	<ul style="list-style-type: none"> <li>Empty the grounds container and clean as described in chapter 5, note 7, then replace.</li> </ul>
INSERT GROUNDS CONTAINER	<ul style="list-style-type: none"> <li>After cleaning, the grounds container has not been replaced.</li> </ul>	<ul style="list-style-type: none"> <li>Open the service door and insert the grounds container.</li> </ul>
ADD PRE-GROUND COFFEE	<ul style="list-style-type: none"> <li>With the ground coffee function selected, ground coffee has not been poured into the funnel.</li> </ul>	<ul style="list-style-type: none"> <li>Add the ground coffee as described in chapter 8.</li> </ul>
FILL BEAN CONTAINER	<ul style="list-style-type: none"> <li>The coffee beans have run out.</li> <li>If the coffee grinder is very noisy, this means a small stone in the coffee beans has blocked the mill.</li> </ul>	<ul style="list-style-type: none"> <li>Fill bean container.</li> <li>Contact an authorised service centre.</li> </ul>
DESCALE	<ul style="list-style-type: none"> <li>This indicates the presence of lime scale in the appliance.</li> </ul>	<ul style="list-style-type: none"> <li>The descaling procedure, described in chapter 12.3, needs to be performed as soon as possible.</li> </ul>
PRESS NEXT+ CHANGE	<ul style="list-style-type: none"> <li>After cleaning, the infuser has probably been left out of the coffee maker.</li> </ul>	<ul style="list-style-type: none"> <li>Leave the service door closed and the infuser out of the appliance, then follow the instructions displayed.</li> </ul>
CLOSE DOOR	<ul style="list-style-type: none"> <li>The service door is open.</li> </ul>	<ul style="list-style-type: none"> <li>If the service door cannot be closed, check that the infuser is inserted correctly (chapter 11.2 - note 1).</li> </ul>
INSERT INFUSER	<ul style="list-style-type: none"> <li>After cleaning, the infuser has probably been left out of the coffee maker.</li> </ul>	<ul style="list-style-type: none"> <li>Insert the infuser, see chapter 11.2.</li> </ul>
GENERAL ALARM	<ul style="list-style-type: none"> <li>The inside of the appliance is very dirty.</li> </ul>	<ul style="list-style-type: none"> <li>Thoroughly clean the inside of the appliance, as described in chapter 11.2. If the message is still displayed after cleaning, contact a service centre.</li> </ul>



## 15 Problems that can be resolved before calling the Customer Care Centre

If the appliance is not working properly, the causes of the malfunction can be identified and resolved by referring to chapter 14. If, on the other hand, no message is displayed, run the following checks before calling the customer care centre.

PROBLEM	CAUSE	SOLUTION
The coffee is not hot	<ul style="list-style-type: none"> <li>The cups have not been preheated.</li> <li>The infuser is too cold</li> </ul>	<ul style="list-style-type: none"> <li>Heat the cups by rinsing them in hot water or leaving them for at least 20 minutes on the cup warmer tray on the lid (see note 3, chapter 5).</li> <li>Heat the infuser by pressing the  button before making the coffee (fig. 11, see note 3, chapter 5).</li> </ul>
The coffee is not creamy enough	<ul style="list-style-type: none"> <li>The coffee is ground too coarsely</li> <li>Wrong type of coffee</li> </ul>	<ul style="list-style-type: none"> <li>Turn the grinding regulator one click anticlockwise (see chapter 7).</li> <li>Use a type of coffee for espresso coffee makers.</li> </ul>
The coffee runs out too slowly.	<ul style="list-style-type: none"> <li>The coffee is ground too finely.</li> </ul>	<ul style="list-style-type: none"> <li>Turn the grinding regulator one click clockwise (see chapter 7).</li> </ul>
The coffee runs out too quickly.	<ul style="list-style-type: none"> <li>The coffee is ground too coarsely.</li> </ul>	<ul style="list-style-type: none"> <li>Turn the grinding regulator one click anticlockwise (see chapter 7).</li> </ul>
The coffee does not come out of one of the spouts.	<ul style="list-style-type: none"> <li>The spout holes are blocked.</li> </ul>	<ul style="list-style-type: none"> <li>Scrape off the dry coffee residues with a needle (fig. 23).</li> </ul>
When the steam button is pressed, no steam comes out of the cappuccino maker.	<ul style="list-style-type: none"> <li>The holes in the cappuccino maker and steam nozzle are clogged.</li> </ul>	<ul style="list-style-type: none"> <li>Clean the holes in the cappuccino maker and the steam nozzle (see chapter 10 - fig. 22).</li> </ul>
When the  ,  or  , button is pressed, the appliance does not deliver coffee, but only water.	<ul style="list-style-type: none"> <li>The ground coffee may be blocked in the funnel.</li> </ul>	<ul style="list-style-type: none"> <li>Remove the ground coffee inside the funnel using a knife (see chapter 8 - note 5). Then clean the infuser and the inside of the appliance (see description in chapter 11.2).</li> </ul>
When the  knob is turned, the appliance does not switch on.	<ul style="list-style-type: none"> <li>The appliance is not plugged in or the main switch on the rear side of the appliance is not switched on.</li> </ul>	<ul style="list-style-type: none"> <li>Check that the power cable is plugged into the mains socket and the main switch is in the ON position.</li> </ul>
The infuser cannot be removed for cleaning.	<ul style="list-style-type: none"> <li>The appliance is on. The infuser can only be removed if the appliance is off.</li> </ul>	<ul style="list-style-type: none"> <li>Turn the appliance off and remove the infuser (see chapter 11.2). <b>IMPORTANT:</b> the infuser can only be removed if the appliance is off. Attempting to remove the infuser when the appliance is on may cause serious damage.</li> </ul>



## 15 Problems that can be resolved before calling the Customer Care Centre

PROBLEM	CAUSE	SOLUTION
Ground coffee is being used (not beans) and the appliance does not pour the coffee.	<ul style="list-style-type: none"> <li>• Too much ground coffee has been added.</li> <li>• The  button has not been pressed and the appliance has used both the ground coffee added and the coffee ground by the mill.</li> <li>• Ground coffee has been added when the appliance is off.</li> </ul>	<ul style="list-style-type: none"> <li>• Remove the infuser and thoroughly clean the inside of the appliance, as described in chapter 11.2. Repeat the operation using a maximum of 1 measure of ground coffee.</li> <li>• Thoroughly clean the inside of the appliance, as described in chapter 11.2. Repeat the operation, first pressing the  button as described in chapter 8.</li> <li>• Remove the infuser and thoroughly clean the inside of the appliance, as described in chapter 11.2. Repeat the operation, but switch the appliance on first</li> </ul>
The coffee does not run out from the spouts, but from around the service door.	<ul style="list-style-type: none"> <li>• The holes in the spouts are clogged with dry coffee.</li> <li>• The mobile container inside the service door is blocked and cannot swing.</li> </ul>	<ul style="list-style-type: none"> <li>• Scrape the holes with a needle (see chapter 11.1, Fig. 23).</li> <li>• Thoroughly clean the mobile container, particularly near the hinges to ensure they are free to swing smoothly.</li> </ul>

## After-Sales Service

**Before contacting the Customer Care Centre:** Switch the appliance on again to see if the problem has been eliminated. If it has not, switch off the appliance and repeat the operation after one hour. If your appliance still does not work properly after carrying out the checks listed in the troubleshooting guide and switching the appliance on again, contact the Customer Care Centre, clearly explaining the problem and specifying:

- the appliance type and serial number (given on the rating plate).
- the type of fault.
- the model.

- the Service number (the number after the word SERVICE on the rating plate inside the appliance).
- your full address.
- your telephone number and area code.

**SERVICE** 0000 000 00000



## Electrical connection for Great Britain and Ireland only

**Warning - this appliance must be earthed**

### Fuse replacement

If the mains lead of this appliance is fitted with a BS 1363A 13amp fused plug, to change a fuse in this type of plug use an A.S.T.A. approved fuse to BS 1362 type and proceed as follows:

1. Remove the fuse cover (A) and fuse (B).
2. Fit replacement 13A fuse into fuse cover.
3. Refit both into plug.

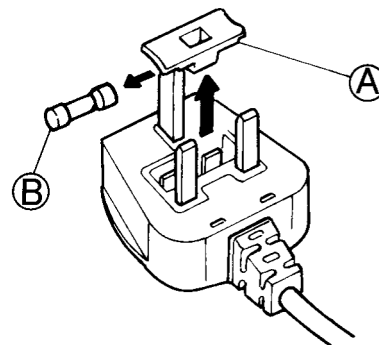

### Important:

The fuse cover must be refitted when changing a fuse and if the fuse cover is lost the plug must not be used until a correct replacement is fitted. Correct replacement are identified by the colour insert or the colour embossed in words on the base of the plug.

Replacement fuse covers are available from your local electrical store.

### For the Republic of Ireland only

The information given in respect of Great Britain will frequently apply, but a third type of plug and socket is also used, the 2-pin, side earth type.

### Socket outlet / plug (valid for both countries)

If the fitted plug is not suitable for your socket outlet, please contact KitchenAid Service for further instruction. Please do not attempt to change plug yourself. This procedure needs to be carried out by a qualified technician in compliance with the manufactures instructions and current standard safety regulations.

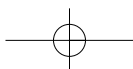
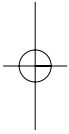

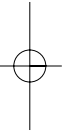
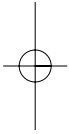

Printed in Italy  
10/07

**5019 744 02003**

GB

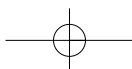

## Free Manuals Download Website

<http://myh66.com>

<http://usermanuals.us>

<http://www.somanuals.com>

<http://www.4manuals.cc>

<http://www.manual-lib.com>

<http://www.404manual.com>

<http://www.luxmanual.com>

<http://aubethermostatmanual.com>

Golf course search by state

<http://golfingnear.com>

Email search by domain

<http://emailbydomain.com>

Auto manuals search

<http://auto.somanuals.com>

TV manuals search

<http://tv.somanuals.com>