

KitchenAid®

HOME APPLIANCES

Installation Instructions

30" and 36" Electric Built-in Ceramic Cooktops

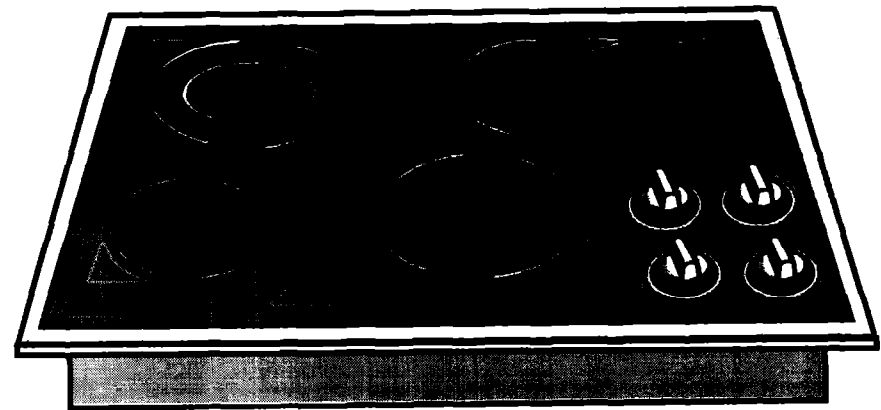

IMPORTANT:
Read and save
these instructions.

IMPORTANT:

Installer: Leave Installation Instructions with the homeowner.

Homeowner: Keep Installation Instructions for future reference.

Save Installation Instructions for local electrical inspector's use.

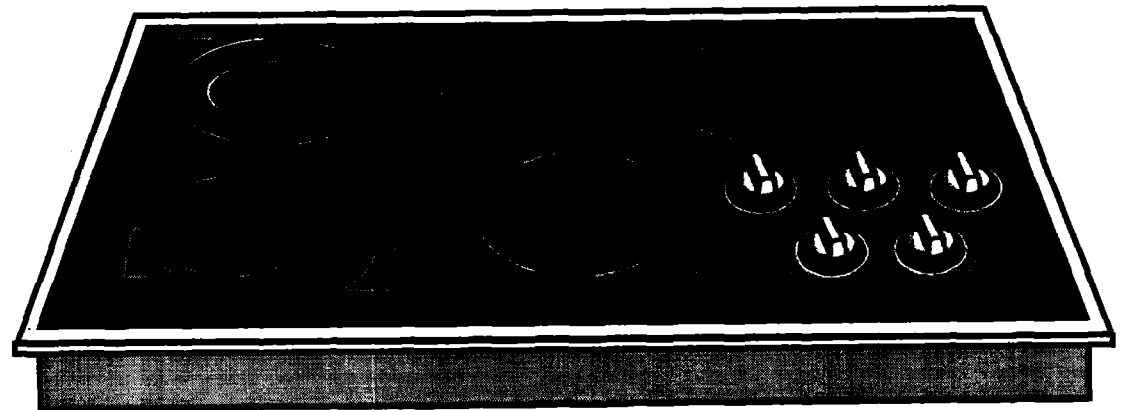

Part No. 4366501

9193

30" Cooktop

* Note: 24" min. clearance if bottom of wood or metal cabinet is protected by not less than 1/4" flame retardant millboard covered with not less than No. 28 MSG sheet steel, 0.015" stainless steel, or 0.024" aluminum or 0.020" copper.

30" min. clearance between top of cooking platform and bottom of unprotected wood or metal cabinet.

30" min. base cabinet is required. If cabinet has a drawer, a 3-1/2" depth clearance from the countertop to the top of the drawer (or other obstruction) in the base cabinet is required.

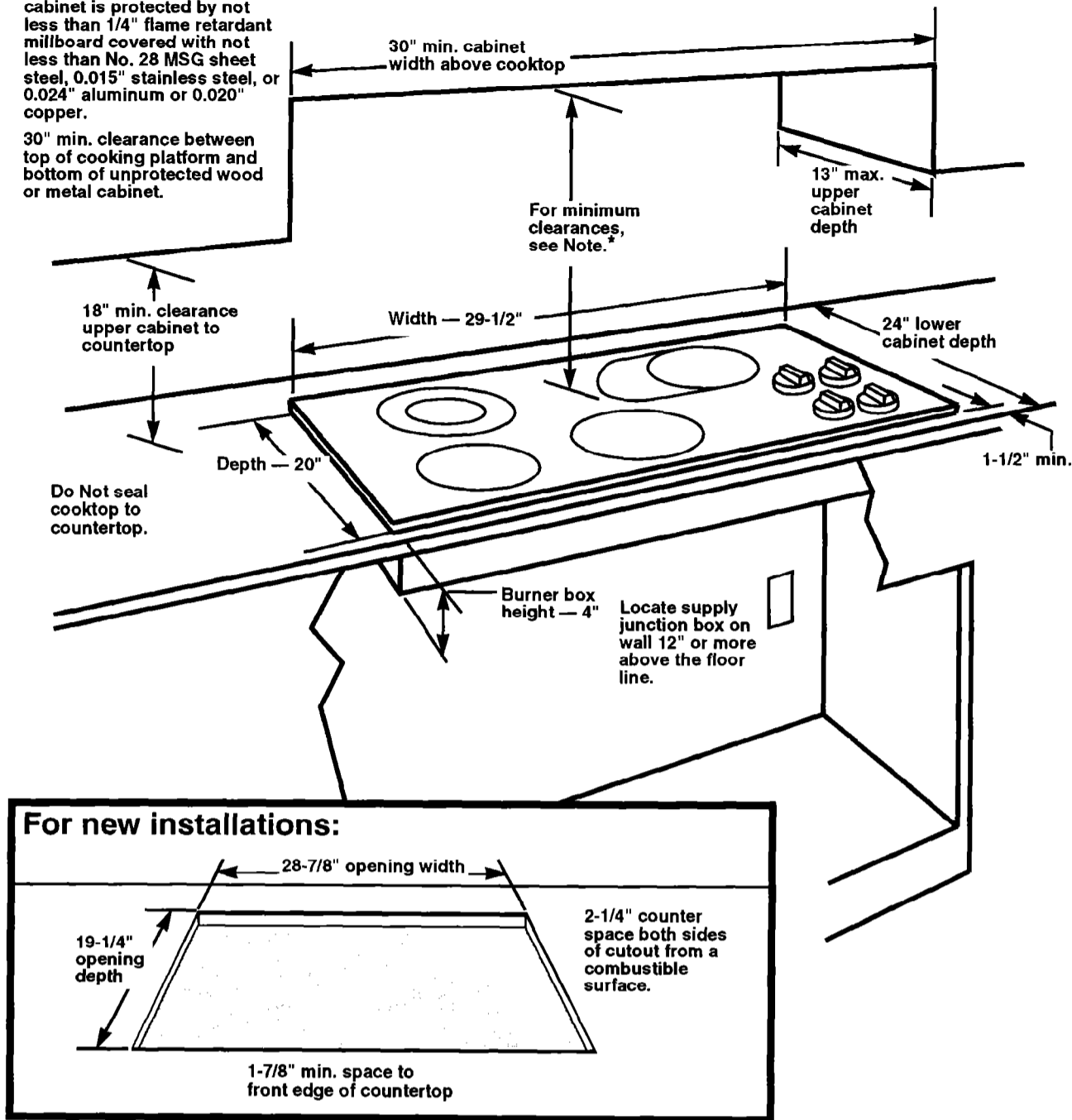

Before you start...

Proper installation is your responsibility. Make sure you have everything for correct installation. It is the responsibility of the installer to comply with the installation clearance specified on the serial/rating plate. The serial/rating plate is found on the bottom of the cooktop.

Check location where cooktop will be installed. The location should be away from strong draft areas, such as windows, doors and strong heating vents or fans. The cooktop should be located for convenient use in the kitchen.

Grounded electrical supply is required. See "Electrical requirements."

Important: Observe all governing codes and ordinances. Failure to meet governing codes and ordinances could lead to fire or electrical shock.

NOTE: The clearances specified are for combustible walls and materials that have a density of 20 or more pounds per cubic foot. No evaluation has been made for installations adjacent to materials that are less than 20 pounds per cubic foot or to plastic tiles and sheeting.

Countertop opening dimensions that are shown must be used. Given dimensions are minimum clearances and provide required 0" clearance.

New installations — follow minimum dimensions given.

Replacement installations — Be sure that front edge of cooktop is at least 1-1/2" back from front edge of countertop.

A built-under oven may be installed under this cooktop if oven is approved for this type of installation. Check for approval label located on top of oven. If label is not located, contact dealer to confirm that oven is approved. Refer to oven manufacturers installation instructions for approval and proper cutout dimensions.

When installing cooktop over a built-under oven. Do Not fasten cooktop to countertop with clamps. Cooktop then will be easy to remove if servicing is ever necessary.

ALL OPENINGS IN THE WALL OR FLOOR WHERE THE COOKTOP IS TO BE INSTALLED MUST BE SEALED.

36" Cooktop

* 24" min. clearance if bottom of wood or metal cabinet is protected by not less than 1/4" flame retardant millboard covered with not less than No. 28 MSG sheet steel, 0.015" stainless steel, or 0.024" aluminum or 0.020" copper.

30" min. clearance between top of cooking platform and bottom of unprotected wood or metal cabinet.

36" min. base cabinet is required. If cabinet has a drawer, a 3-1/2" depth clearance from the countertop to the top of the drawer (or other obstruction) in the base cabinet is required.

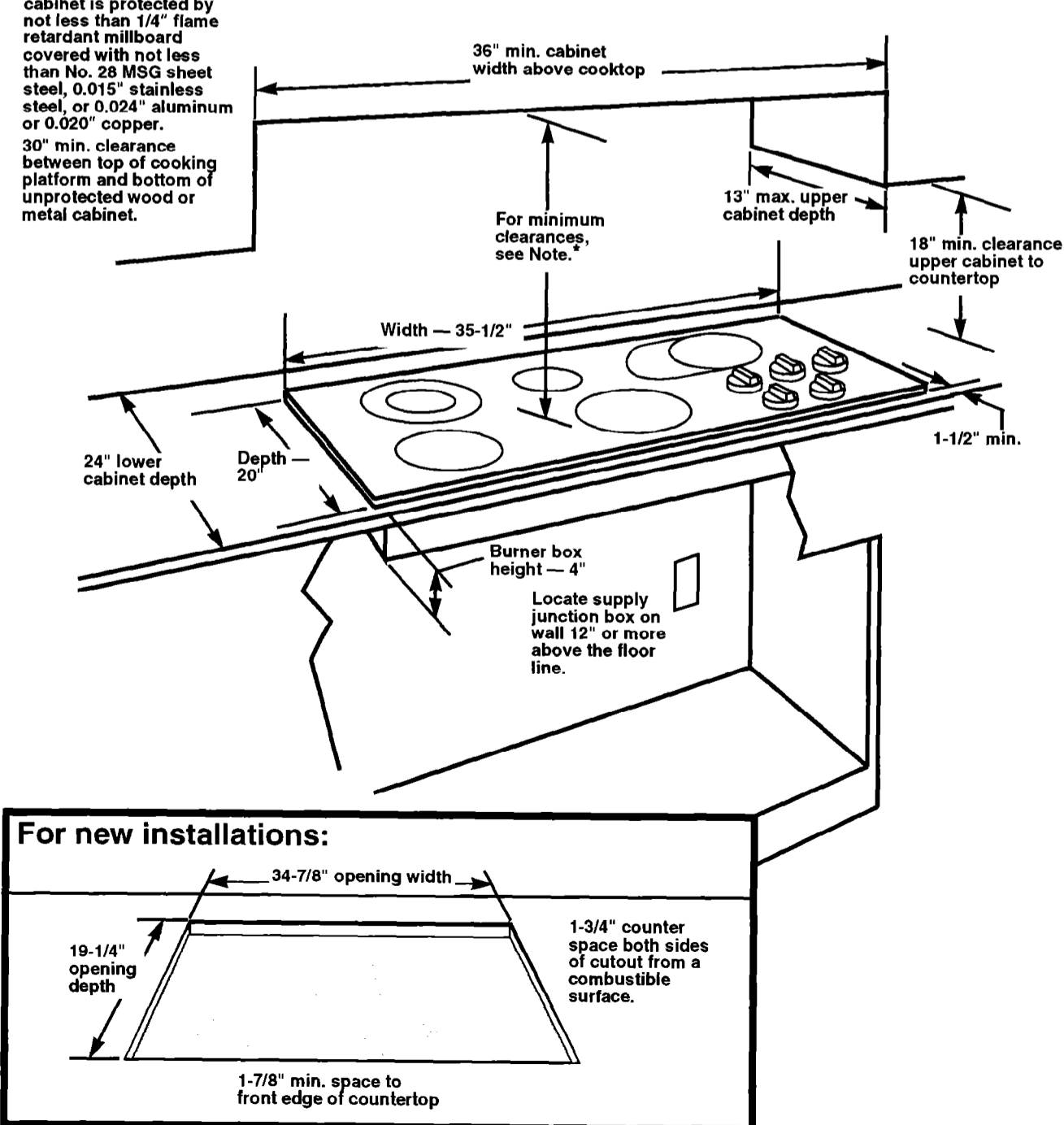

WARNING

Electrical Shock Hazard

It is the customer's responsibility:

- To contact a qualified electrical installer.
- To assure that the electrical installation is adequate and in conformance with National Electrical Code, ANSI/NFPA 70 — latest edition**, and all local codes and ordinances.

Failure to do so could result in electrical shock or other personal injury.

Personal Injury Hazard

Cabinet storage above the cooking surface should be avoided. If cabinets are already installed, reduce the hazard of reaching over a heated cooking surface by installing a range hood.

The range hood should extend a minimum of 5 inches out from the bottom of the cabinets.

Reaching over a heated cooking surface could result in a serious burn.

Tools needed for installation:

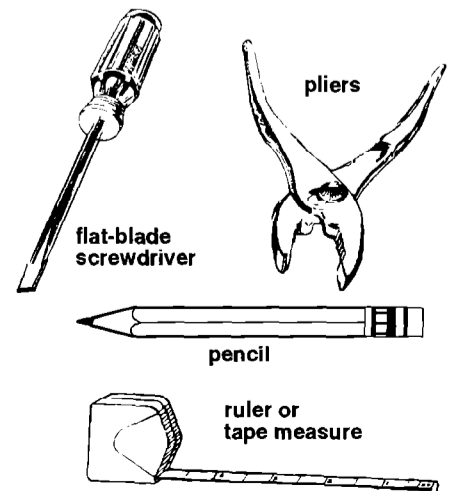

Electrical requirements

⚠ WARNING

Electrical Shock Hazard

- Electrical ground is required on this appliance.
- If cold water pipe is interrupted by plastic, non-metallic gaskets, or other insulating materials, Do Not use for grounding.
- Do Not ground to a gas pipe.
- Do Not have a fuse in the neutral or grounding circuit. A fuse in the neutral or grounding circuit could result in an electrical shock.
- Check with a qualified electrician if you are in doubt as to whether the appliance is properly grounded. Failure to follow these instructions could result in serious injury or death.

If codes permit and a separate grounding wire is used, it is recommended that a qualified electrician determine that the grounding path is adequate.

IMPORTANT:

Save Installation Instructions for electrical inspector's use.

A. A three-wire or four-wire, single phase, 240-volt, 60-Hz, AC-only electrical supply is required on a separate, 40-ampere circuit, fused on both sides of the line. A time-delay fuse or circuit breaker is recommended. The fuse size must not exceed the circuit rating of the appliance specified on the serial/rating plate located on the bottom of the cooktop.

B. THE COOKTOP MUST BE CONNECTED WITH COPPER WIRE ONLY.

C. Wire sizes and connections must conform to the requirements of the National Electrical Code ANSI/NFPA — latest edition**, and all local codes and ordinances.

Copies of the standards listed may be obtained from:

**National Fire Protection Association
Batterymarch Park
Quincy, Massachusetts 02269

D. Wire sizes (COPPER WIRE ONLY) and connections must conform with the rating of the appliance (40 amperes). The appliance should be connected directly to the fused disconnect or circuit breaker box through flexible, armored or non-metallic sheathed, copper cable. The flexible, armored cable extending from the appliance should be connected directly to the junction box.

E. Locate the junction box to allow as much slack as possible between junction box and the cooktop so that the cooktop can be moved if servicing is ever necessary.

F. A U.L.-listed conduit connector must be provided at each end of the power supply cable (at the appliance and at the junction box).

Electrical connection

This appliance is manufactured with a cabinet-connected, green or bare grounding wire. Connect the appliance cable to the junction box through the U.L.-listed conduit connector. Complete electrical connection according to local codes and ordinances.

A. Where local codes permit connecting the frame-grounding conductor to the neutral (white) junction box wire:

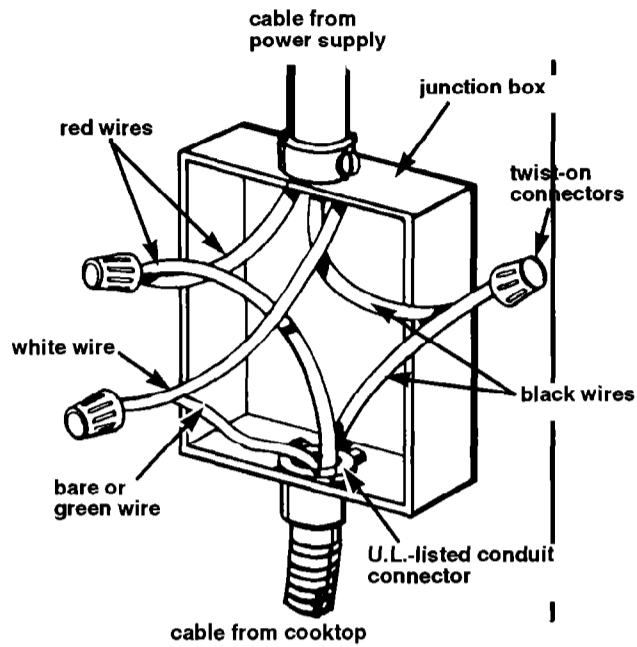

Grounded neutral

Figure 1

1. Disconnect power supply.
2. Connect the flexible armored cable from the cooktop to the junction box using a U.L.-listed conduit connector. Tighten screws on conduit connector.
3. Connect the green (or bare) appliance cable wire with the neutral (white) wire in the junction box.
4. Connect the two black wires together; then connect the two red wires together. (See Figure 1.)

B. Where local codes Do Not permit connecting the frame-grounding conductor to the neutral (white) junction box wire:

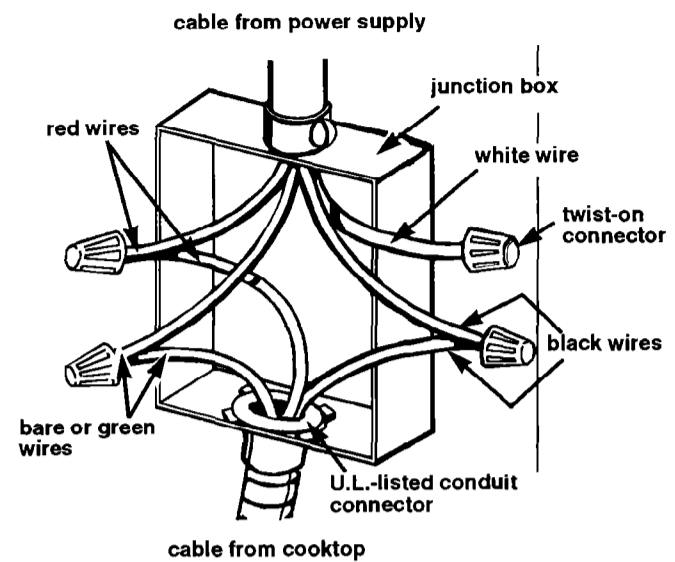

Ungrounded neutral

Figure 2

1. Disconnect power supply.
2. Connect the flexible armored cable from the cooktop to the junction box using a U.L.-listed conduit connector. Tighten screws on conduit connector.
3. Connect the two black wires together; then connect the two red wires together. (See Figure 2.)
4. Connect the green or bare grounding wire from the appliance cable to the grounded wire in the junction box.
5. Put a twist-on connector on end of white wire.

Now start...

With cooktop in kitchen.

CAUTION

Property Damage
Lift entire cooktop up from cutout when repositioning cooktop in countertop opening. Failure to do so could scratch the countertop.

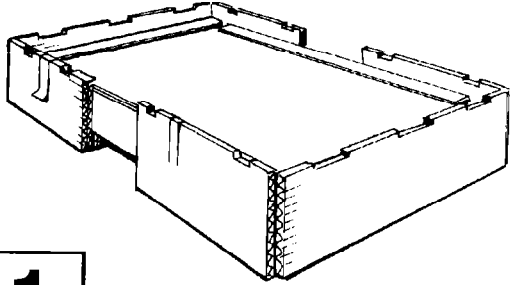

1. Remove the shipping materials and tape from the cooktop or grill. Remove the hardware package from the side of the carton.

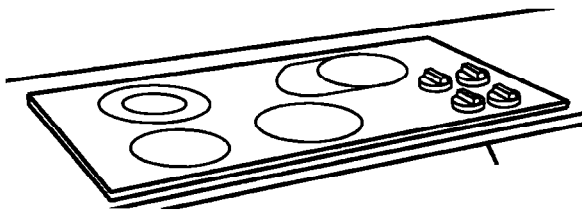

2. Insert the cooktop into the countertop. Center the cooktop in the cutout. Check that the front of the cooktop is parallel to the front edge of the countertop. Check that all required clearances are met.

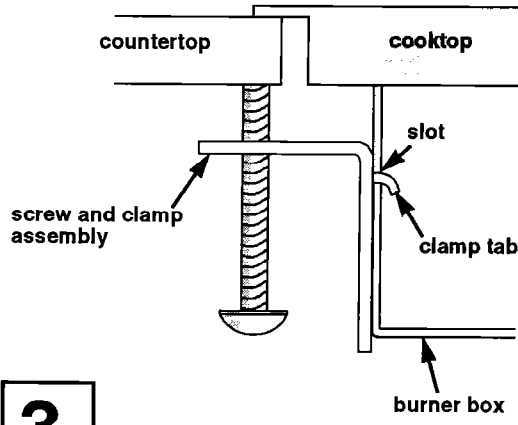
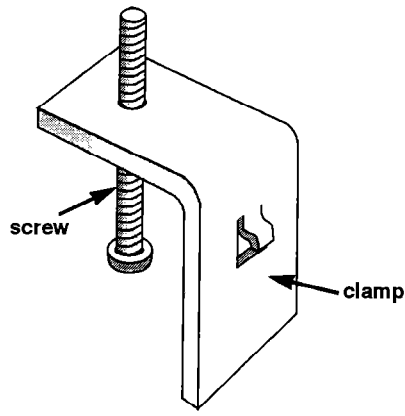

3. Insert one clamp tab through each slot located on sides of the burner box.

WARNING

Personal Injury Hazard
Do Not overtighten screws. Overtightening screws could damage cooktop surface.

4. Secure cooktop to countertop by hand-tightening each screw; then use a screwdriver to tighten each screw 1 to 1-1/2 more turns. Do Not overtighten screws.

5. Make electrical connection. (See "Electrical requirements" and "Electrical connection" sections, Panel B.)

6. Turn on power supply.

WARNING

Personal Injury Hazard
Do Not touch cooktop surface. Areas near elements may be hot. Touching a heated cooking surface could result in a serious burn.

7. Push in and turn each control knob to the "HI" position. Check the operation of the cooktop elements and indicator lights.

To get the most efficient use from your new cooktop, read your KitchenAid Use and Care Guide. Keep Installation Instructions and Guide close to cooktop for easy reference.

Numbers correspond to steps.

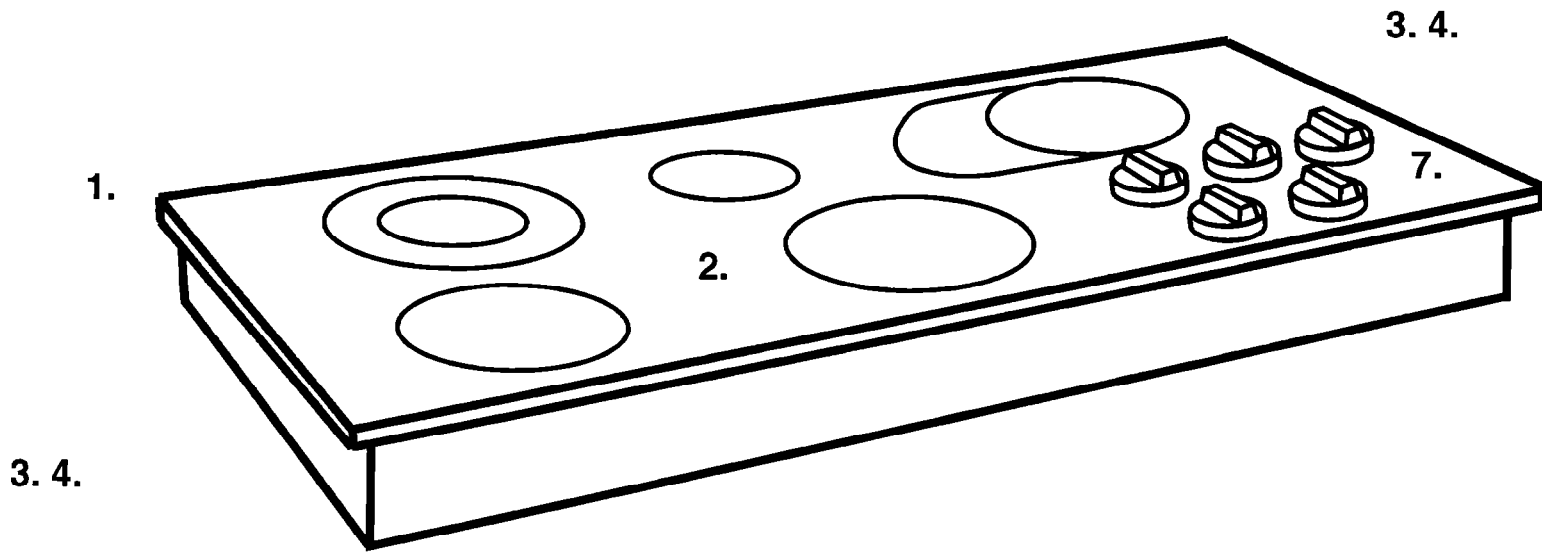

If cooktop does not operate...

Check that the circuit breaker is not tripped or the house fuse blown. Check that power supply cord is plugged into wall receptacle. A more detailed troubleshooting checklist is provided in the Use and Care Guide.

If you need assistance...

The KitchenAid Consumer Assistance Center will answer any questions about operating or maintaining your cooktop not covered in the Installation Instructions. The KitchenAid Consumer Assistance Center is open 24 hours a day, 7 days a week. Just dial, 1-(800) 422-1230 — the call is free.

When you call, you will need the cooktop model number and serial number. Both numbers can be found on the serial/rating plate located on the bottom of the cooktop.

If you need service...

In the event that your KitchenAid appliance should need service, call the dealer from whom you purchased the appliance or a KitchenAid-authorized service company. A KitchenAid-authorized service company is listed in the Yellow Pages of your telephone directory under "Appliances — Household — Major — Service or Repair". You can also obtain the service company's name and telephone number by dialing, free, within the continental United States, the KitchenAid Consumer Assistance Center telephone number, 1-(800) 422-1230. A special operator will tell you the name and number of your nearest KitchenAid-authorized service company.

Maintain the quality built into your KitchenAid appliance — call a KitchenAid-authorized service company.

KitchenAid[®]
HOME APPLIANCES

Part No. 4366501
© 1993 KitchenAid
® KitchenAid. Registered Trademark of KitchenAid.

Prepared by KitchenAid, St. Joseph, Michigan 49085



Printed on recycled paper.
10% post consumer waste/
50% recovered materials.
Printed in U.S.A.

Free Manuals Download Website

<http://myh66.com>

<http://usermanuals.us>

<http://www.somanuals.com>

<http://www.4manuals.cc>

<http://www.manual-lib.com>

<http://www.404manual.com>

<http://www.luxmanual.com>

<http://aubethermostatmanual.com>

Golf course search by state

<http://golfingnear.com>

Email search by domain

<http://emailbydomain.com>

Auto manuals search

<http://auto.somanuals.com>

TV manuals search

<http://tv.somanuals.com>