

# KitchenAid®

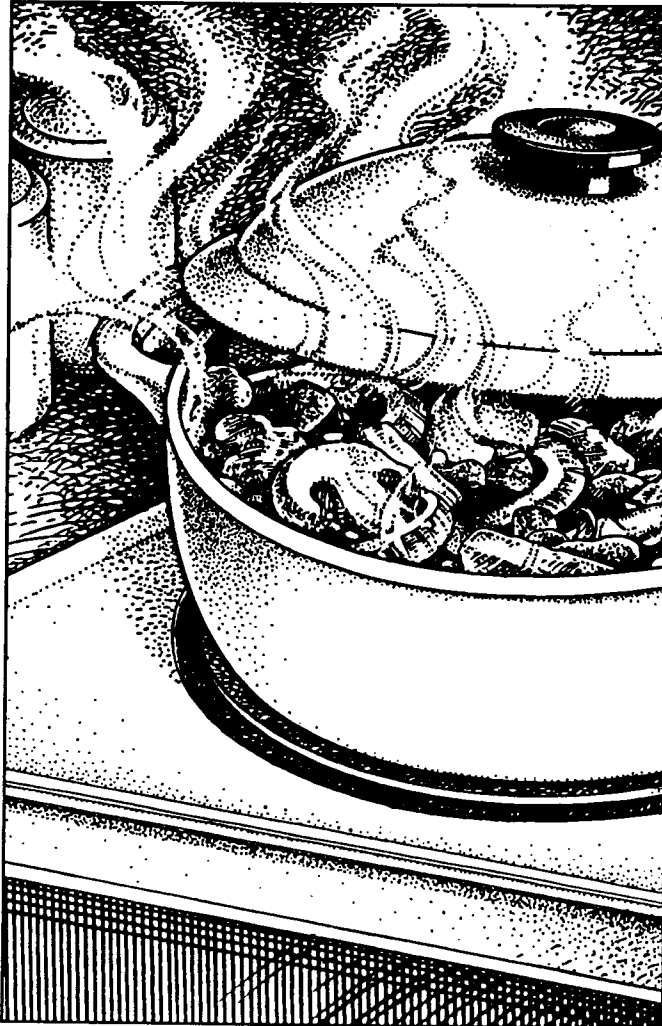

FOR THE WAY IT'S MADE.™



TO THE INSTALLER: PLEASE LEAVE THIS INSTRUCTION BOOK WITH THE UNIT.

TO THE CONSUMER: PLEASE READ AND KEEP THIS BOOK FOR FUTURE REFERENCE.

## KitchenAid® Create-A-Cooktop™

Models KECT025 KECC027  
KGCT025 KECG020  
KSVD060

A Note to You .....	2
Important Safety Instructions .....	3
Parts and Features .....	7
Cookware .....	10
Electric Cooktop with Cast-Iron Surface Units	
Use .....	10
Care .....	12
Electric Ceramic Cooktop with Radiant/Halogen Surface Units	
Use .....	16
Care .....	18
Gas Cooktop with Sealed Burners	
Use .....	21
Care .....	23
Electric Grill	
Use .....	28
Care .....	30
Side Mount Downdraft Vent System	
Use .....	32
Care .....	33
If You Need Assistance or Service .....	35
KitchenAid Warranty .....	40

Call us with questions  
or comments:

**1-800-422-1230**

# Use and Care Guide

10193

# A Note to You

*Thank you!*

Thank you for buying a KitchenAid home appliance. You have purchased a quality, *world-class* product. Years of engineering experience went into its manufacturing. To ensure that you enjoy many years of trouble-free operation, we developed this Use and Care Guide. It is full of valuable information on how to operate and maintain your home appliance properly and safely. Please read it carefully. Also, please complete and mail the Ownership Registration Card provided with your new home appliance.

## Your safety is important to us.

This guide contains safety symbols and statements. Please pay special attention to these symbols and follow any instructions given. Here is a brief explanation of the use of each symbol.

### **WARNING**

This symbol will help alert you to such dangers as personal injury, burns, fire and electrical shock.

### **CAUTION**

This symbol will help you avoid actions which could cause product damage (scratches, dents, etc.) and damage to your personal property.

## Our Consumer Assistance Center telephone number, 1-800-422-1230, is toll-free 24 hours a day.

If you ever have a question concerning your home appliance's operation, or if you need service, feel free to call our toll-free Consumer Assistance Center telephone number for help. When calling, you will need to know your appliance's complete model number and serial number. You can find this information on the model and serial number plate (see diagrams on pages 7-9). For your convenience, we have included a handy place below for you to record these numbers, as well as purchase information. You will need this information if you ever require service. Keep this book and the sales slip together in a safe place for future reference.

**NOTE:** You must provide proof of purchase or installation date for in-warranty service.

Model Number \_\_\_\_\_ Builder/Dealer Name \_\_\_\_\_  
Serial Number \_\_\_\_\_ Address \_\_\_\_\_  
Date Installed \_\_\_\_\_ Phone \_\_\_\_\_

# Important Safety Instructions

## READ AND SAVE THESE INSTRUCTIONS

Your cooktop is built according to the most strict safety standards possible. However, as with any appliance that gets hot and that is connected to electricity and/or gas, this cooktop requires care when in use. Following are a few precautions you should review before using your cooktop.

### **! WARNING**

To reduce the risk of fire, electrical shock, injury to persons, or damage when using the cooktop, follow basic precautions, including the following:

**WARNING:** If the information in this manual is not followed exactly, a fire or explosion may result causing property damage, personal injury or death.

**DO NOT STORE OR USE GASOLINE OR OTHER FLAMMABLE VAPORS AND LIQUIDS IN THE VICINITY OF THIS OR ANY OTHER APPLIANCE.**

#### **WHAT TO DO IF YOU SMELL GAS:**

- DO NOT TRY TO LIGHT ANY APPLIANCE.
- DO NOT TOUCH ANY ELECTRICAL SWITCH; DO NOT USE ANY PHONE IN YOUR BUILDING.
- IMMEDIATELY CALL YOUR GAS SUPPLIER FROM A NEIGHBOR'S PHONE. FOLLOW THE GAS SUPPLIER'S INSTRUCTIONS.
- IF YOU CANNOT REACH YOUR GAS SUPPLIER, CALL THE FIRE DEPARTMENT.

**INSTALLATION AND SERVICE MUST BE PERFORMED BY A QUALIFIED INSTALLER, SERVICE AGENCY OR THE GAS SUPPLIER.**

#### **General**

- Install or locate the cooktop only in accordance with the provided Installation Instructions. The cooktop must be installed by a qualified installer. The cooktop must be properly connected to the proper gas supply and checked for leaks. The cooktop must also be properly connected to electrical supply and grounded.
- **CAUTION:** Do not store things children might want above the cooktop. Children could be burned or injured while climbing on it.
- Do not leave children alone or unattended in area where the cooktop is in use. They should never be allowed to sit or stand on any part of the cooktop. They could be burned or injured.

continued on next page



## Important Safety Instructions

- Do not operate the cooktop if it is damaged or not working properly.
- Do not cook on a broken cooktop. If cooktop should break, cleaning solutions and spillovers may penetrate the broken cooktop and create a risk of electrical shock. Contact a qualified technician immediately.
- Do not use the cooktop for warming or heating the room. Persons could be burned or injured, or a fire could start.
- Use the cooktop only for its intended use as described in this manual.



- Do not touch surface burners/units or areas near surface burners/units. Surface units may be hot even though they are dark in color. Areas near surface burners/units become hot enough to cause burns. During use, do not touch, or let clothing or other flammable materials contact surface burners/units or areas near surface burners/units until they have had sufficient time to cool.



- Do not wear loose or hanging garments when using the cooktop. They could ignite if they touch an open flame and you could be burned.
- Make sure the utensils you use are large enough to contain food and avoid boilovers and spillovers. Heavy splattering or spillovers left on a cooktop can ignite and burn you. Pan size is especially important in deep fat frying.

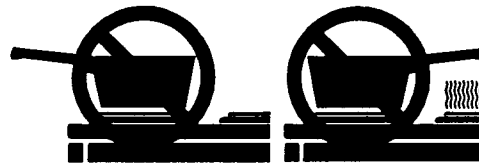

- Turn pan handles inward, but not over other surface burners/units. This will help reduce the chance of burns, igniting of flammable materials, and spills due to bumping of the pan.
- Use only dry potholders. Moist or damp potholders on hot surfaces may result in burns from steam. Do not let potholder touch an open flame or hot heating elements. Do not use a towel or bulky cloth for a potholder. It could catch on fire.

- Check to be sure glass cooking utensils are safe for use on the cooktop. Only certain types of glass, glass-ceramic, ceramic, earthenware or other glazed utensils are suitable for cooktops without breaking due to the sudden change in temperature.
- Do not use decorative covers or trivets over the surface burners.
- Do not heat unopened containers. They could explode. The hot contents could cause burns and container particles could cause injury.
- Never leave surface burners/units unattended at high heat settings. A boilover could result and cause smoking and greasy spillovers that may ignite.
- Do not store flammable materials on or near the cooktop. The fumes can create an explosion and/or fire hazard.

### **Gas cooktop**

---

- Gas fuels and their use in appliances can cause minor exposures to benzene, formaldehyde, carbon monoxide and soot, primarily from incomplete combustion. Significant exposure to these substances can cause cancer or reproductive harm.

Properly adjusted burners with a blue, rather than a yellow, flame will minimize incomplete combustion. Venting with a hood or an open window will further minimize exposure.

- Never use a match or other flame to look for a gas leak. Explosion and injury could result.
- Know where your main gas shutoff valve is located.

### **Grease**

---

- Grease is flammable. Do not allow grease to collect around cooktop or in vents. Wipe spillovers immediately.



- Do not use water on grease fires. Never pick up a flaming pan. Smother flaming pan by covering with a well-fitted lid, cookie sheet or flat tray. Flaming grease outside of pan can be extinguished with baking soda or, if available, a multipurpose dry chemical or foam-type extinguisher.

### **Grill**

---

- Do not use utensils (pots and pans) on the grill.

continued on next page



## Important Safety Instructions

### **Vent system**

- Do not block the vent system.
- Do not put hands in vent box when fan is on. Injury could result.
- Filter must be in place for proper vent system operation.

### **Care and cleaning**

- Clean cooktop with care. Some cleaners can produce noxious fumes if applied to a hot surface. If a wet paper towel is used to wipe spills on a hot cooking area, be careful to avoid steam burns.

- Do not repair or replace any part of the cooktop unless specifically recommended in this manual. All other servicing should be referred to a qualified technician.
- Any additions, changes or conversions required in order for this appliance to satisfactorily meet the application needs must be made by a KitchenAid servicer or Qualified Agency.
- Disconnect the electrical supply and/or gas supply at the shutoff valve near the cooktop before servicing the cooktop.

**– READ AND SAVE THESE INSTRUCTIONS –**

## Help us help you

### **Please:**

- **Make sure** the cooktop is not used by anyone unable to operate it properly.
- **Properly maintain** the cooktop.
- **Use the cooktop** only as described in this manual.

# Parts and Features

## Welcome to the world of customized cooktop cooking!

With your Create-A-Cooktop™, you can combine several cooktops into one. Depending on which capabilities you want your cooktop to have, your unit can include one or more of any of the following components: Electric Cooktop with Cast-Iron Surface Units, Electric Ceramic Cooktop with Radiant/Halogen Surface Units, Gas Cooktop with Sealed Burners, Electric Grill, and Side

Mount Downdraft Vent System. (For information on installing your Create-A-Cooktop, see the Installation Instructions included with your unit.)

This section contains captioned illustrations of each component available to you. Use them to become familiar with the location and appearance of all parts and features.

## Electric cooktop with cast-iron surface units (model KECT025)

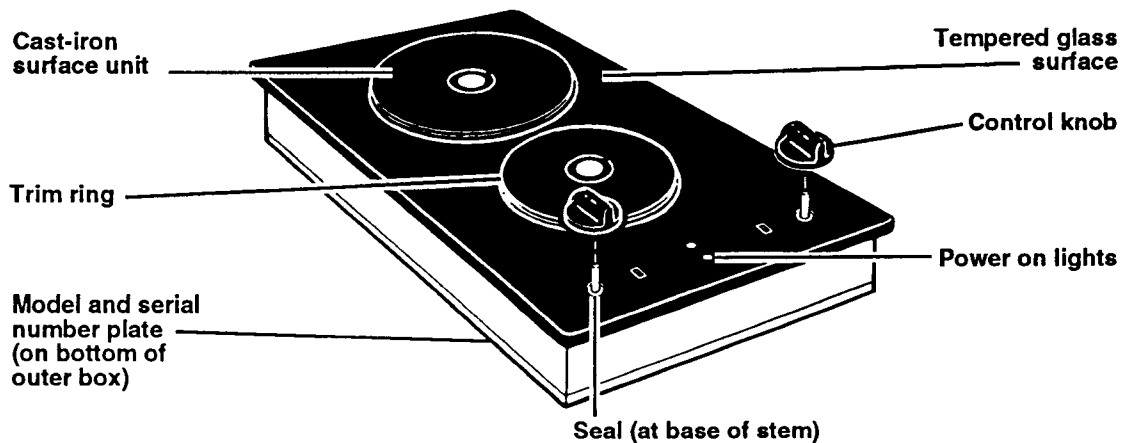

## Electric ceramic cooktop with radiant/ halogen surface units

(model KECC027)

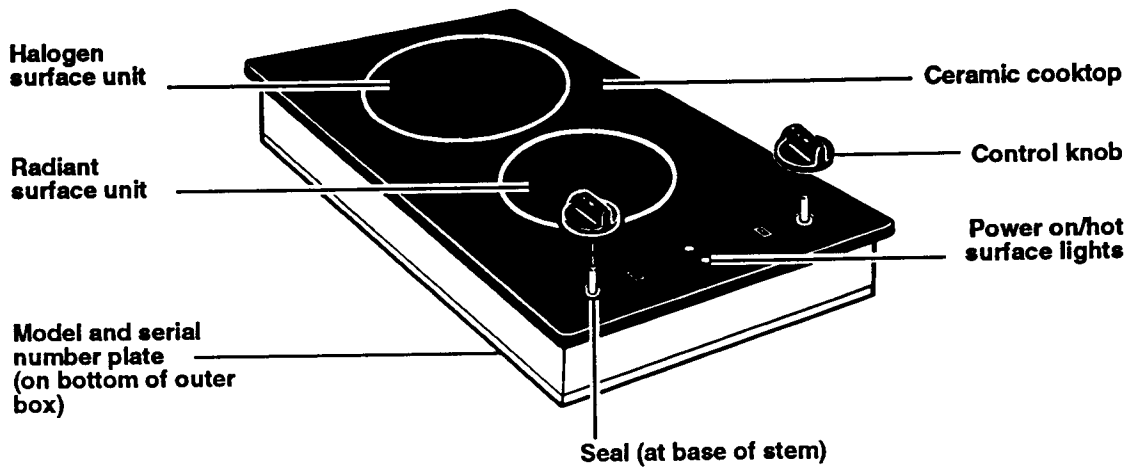

## Gas cooktop with sealed burners

(model KGCT025)

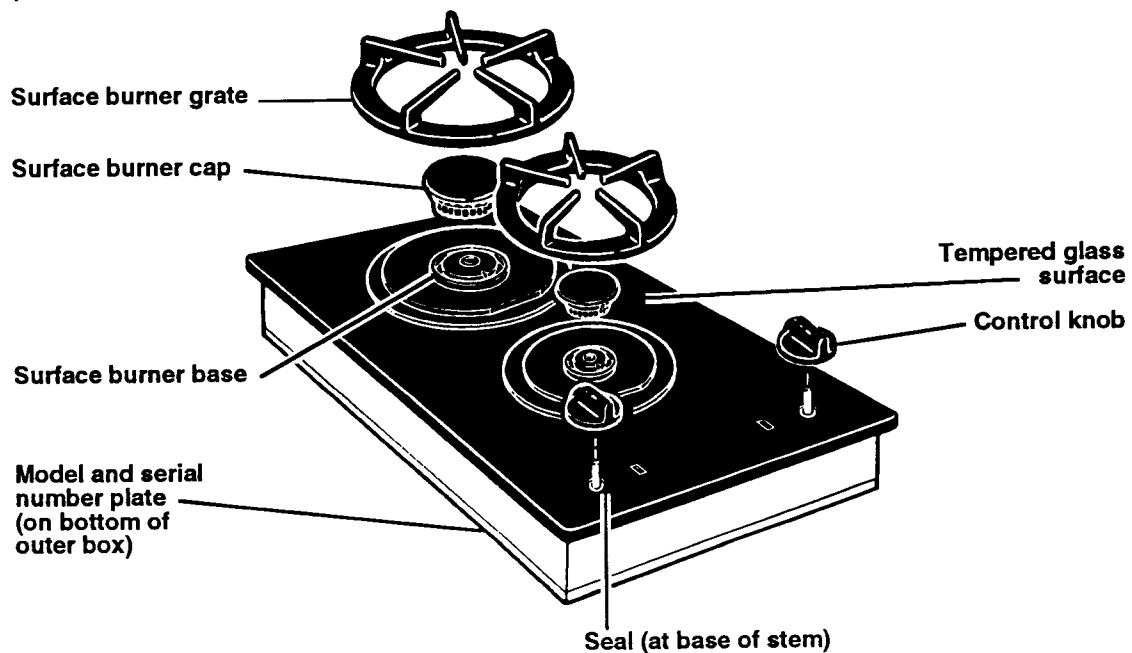



## Electric grill (model KECG020)

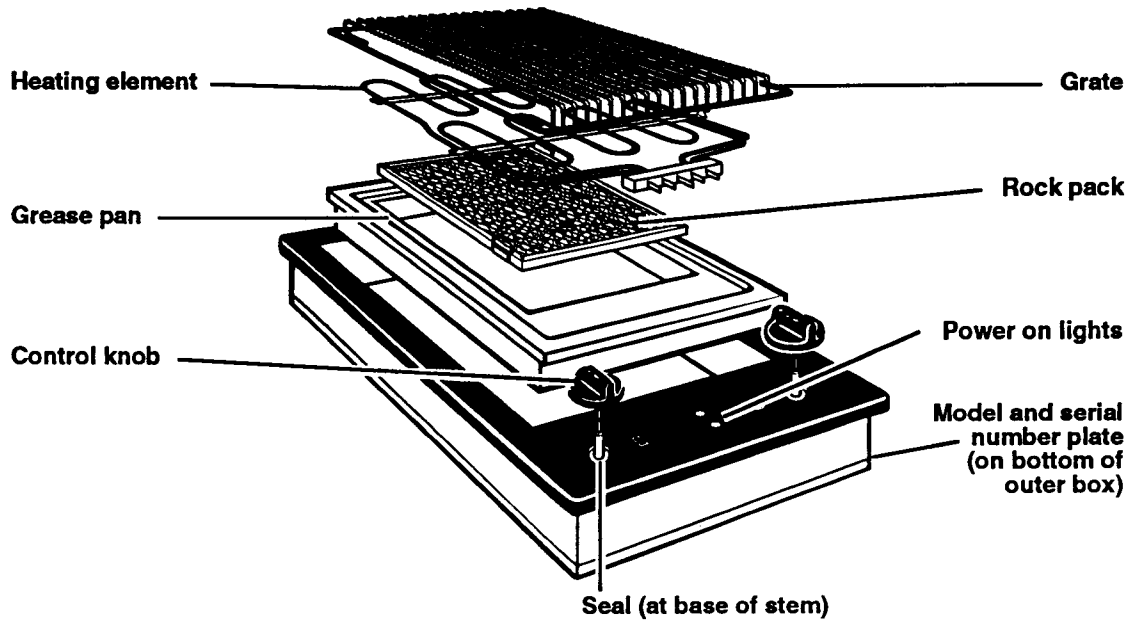

## Side mount downdraft vent system (model KSVD060)

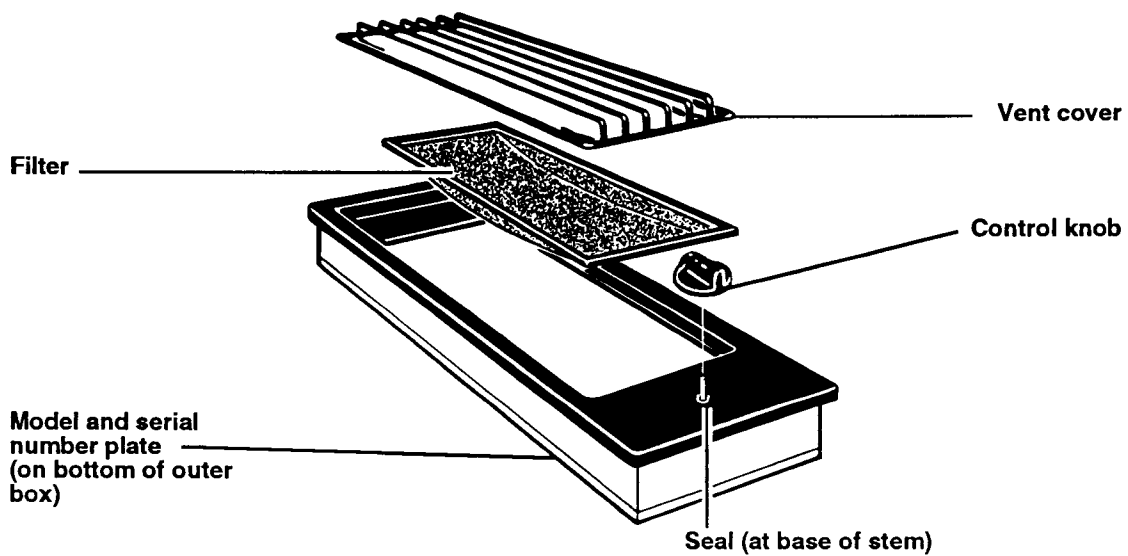

# Cookware

(all models)

- Select a pan that is about the same size as the surface unit/burner.
- **NOTE: For best results and greater energy efficiency, use only flat-bottomed cookware in good condition. For electric cooktops, use cookware that makes good contact with the surface units. Cookware with rounded, warped, ribbed (such as some porcelain enamelware) or dented bottoms could cause uneven heating and poor cooking results on electric cooktops.**  
You can, however, use the new cookware available with slightly indented bottoms or very small expansion channels. This cookware is specially designed to provide the good contact needed for best cooking results.  
Also, woks, canners and teakettles with flat bottoms suitable for use on your cooktop are now available in most stores that sell housewares.
- The pan should have straight sides and a tight-fitting lid.
- Choose medium to heavy gauge (thickness) pans that are fairly lightweight.
- The pan material (metal or glass) affects how fast heat transfers from the surface unit/burner through the pan material and how evenly heat spreads over the pan bottom. Choose pans that provide the best cooking results.
- Handles should be made of sturdy, heat-resistant material and be securely attached to the pan.

## Electric Cooktop with Cast-Iron Surface Units

### Use

In This Section		Page	Page
Power on lights .....	11	Control setting guide .....	11
Surface unit markers .....	11	The cast-iron surface units .....	12

Cast-iron surface units may retain heat for a longer period of time than standard surface units. To get the most out of this cooktop, please read the following instructions.

## Power on lights

One of the Power On Lights on the control panel glows when a surface unit is turned on. The top light works with the rear surface unit, while the bottom light works with the front surface unit.



## Surface unit markers

The solid dot in the surface unit marker shows which surface unit is turned on by that knob.

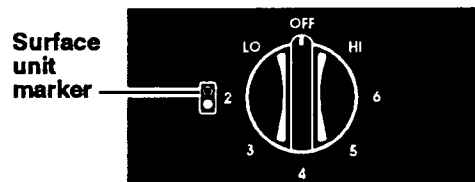

## Control setting guide

### **⚠ WARNING**

#### **Burn and Fire Hazard**

Be sure both control knobs are turned to OFF and the Power On Lights are OFF when you are not cooking.

Someone could be burned or a fire could start if a surface unit is accidentally left ON.

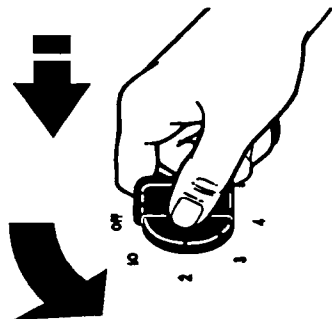

Push in controls before turning to a setting. You can set them anywhere between HI and OFF.

Until you get used to the settings, use the chart below as a guide. For best results, start cooking at the high setting; then turn the control knob down to continue cooking.

SETTING	RECOMMENDED USE
HI	<ul style="list-style-type: none"> <li>To start foods cooking.</li> <li>To bring liquids to a boil.</li> <li>Turn to LO or 3-2 when sizzle starts.</li> </ul>
6-5	<ul style="list-style-type: none"> <li>To hold a rapid boil.</li> <li>To fry chicken or pancakes.</li> <li>Turn to LO or 3-2 when sizzle starts.</li> </ul>
4	<ul style="list-style-type: none"> <li>For gravy, pudding and icing.</li> <li>To cook large amounts of vegetables.</li> <li>Turn to LO to finish cooking.</li> </ul>
3-2	<ul style="list-style-type: none"> <li>To keep food cooking after starting it on a higher setting.</li> </ul>
LO	<ul style="list-style-type: none"> <li>To keep food warm until ready to serve.</li> </ul>



## The cast-iron surface units

Cast-iron surface units are made of heavy cast-iron to provide even cooking. Each surface unit has a built-in protective limiter as a safety feature.

The limiter will automatically reduce the heat level to provide even cooking temperatures and to protect the surface unit.

### The limiter senses uneven cooking temperatures when:

- A pan boils dry.
- A pan is removed and the surface unit is left on.
- The bottom of the pan is too large or too small for the surface unit. This will result in longer cooking times.
- The bottom of the pan is rounded, warped, ribbed or dented and does not make full contact with the surface unit.

**NOTE:** Cast-iron surface units stay hot for a long time. Do not use the HI setting for long periods of time or leave pans on hot surface units when cooking is done. Burned food and damage to the cookware could result. You may want to turn the cast-iron surface unit off a few minutes before you finish cooking.

**Before placing a pan on cast-iron surface units for the first time,** heat on HI setting for five minutes. The surface units will give off smoke as the protective coating, applied at the factory, finishes bonding to the surface.

## Care

In This Section		Page	Page
Control knobs .....	13	The cast-iron surface units .....	14
Tempered glass surface .....	13	Cleaning chart .....	15

Your cooktop is designed for easy care. You can do most cleaning with items found around your home. Clean your cooktop whenever spills or soiling occurs to keep it looking and operating like new.

**⚠ WARNING**

**Burn and Electrical Shock Hazard**  
 Make sure all controls are OFF and the cooktop is cool before cleaning. Do not allow moisture to collect in control area when cleaning.  
 Failure to do so could result in burns or electrical shock.

---

## Control knobs

1. **Make sure** all control knobs are turned to OFF.
2. **Pull** the control knobs straight off.
3. **Wash** control knobs with sponge and warm, soapy water. **Rinse** well and **dry** with a soft cloth. Do not soak.
4. **Replace** control knobs by pushing them firmly into place.

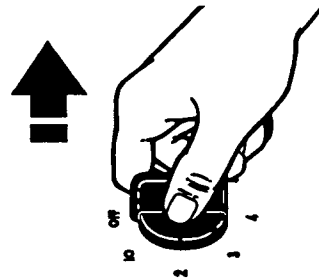

### NOTES:

- **When cleaning**, never use steel wool, abrasives, or commercial oven cleaners which may damage the finish. After cleaning, make sure all control knobs point to OFF.
- **To prevent moisture** from collecting in control area, do not remove seals under control knobs. Wipe up spills in control area as soon as they occur.

---

## Tempered glass surface

1. **Wipe** with sponge and warm, soapy water or paper towel and mild glass cleaner.
2. **Dry** with a soft cloth.
3. If soap or detergent solutions are used, **make sure** to rinse thoroughly to prevent filmy residue.

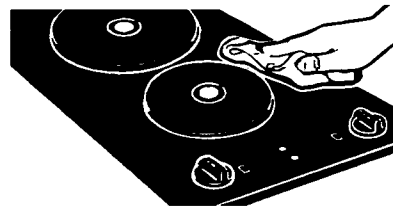

**NOTE:** When cleaning cooktop with knobs removed, **DO NOT** allow water to run down inside unit. When cleaning, never use steel wool, abrasives, or commercial oven cleaners which may damage the finish.



---

### The cast-iron surface units

1. **For best results, wipe off surface units with a damp sponge and soapy water after each use. Remove burned-on food with a nonabrasive, soap-filled scouring pad. The red spot in the center of the surface unit will gradually wash off. This is normal and will not affect the operation of the surface unit.**
2. **Dry the surface unit completely after cleaning. Turn on the surface unit for few minutes to thoroughly dry.**
3. **After the surface unit has cooled, use a paper towel to apply a thin coat of salt-free oil to the surface units to season and restore the finish. Wipe excess oil off trim rings.**
4. **Then heat 3-5 minutes. Some smoking may occur; this is normal. If surface units have dark spots caused by grease and food, the oil treatment will improve their appearance but not eliminate the spots.**

**NOTE:** You can apply optional Electrol<sup>®</sup> dressing to the surface units to improve their appearance.

**To obtain order information for Electrol dressing (Part No. 814030), write to:**

KitchenAid  
Parts Distribution Center  
123 Koomler Drive  
LaPorte, IN 46350

**OR**

Call 1-800-422-1230 to order. You must have a major credit card to order by phone.

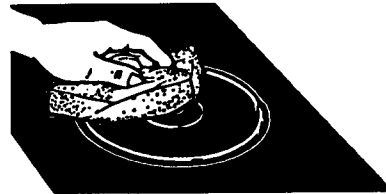

## Cleaning chart

Use this chart for proper and effective cleaning of your cast-iron surface unit cooktop.

PART	WHAT TO USE	HOW TO CLEAN
<b>Control knobs</b>	Warm, soapy water and a sponge	<ul style="list-style-type: none"> <li>• Wash, rinse and dry well.</li> <li>• Do not soak.</li> <li>• <b>Do not remove seals under control knobs.</b></li> </ul>
<b>Tempered glass surface</b>	Sponge and warm, soapy water or paper towel and spray glass cleaner	<ul style="list-style-type: none"> <li>• Wipe off regularly when cooktop is cool.</li> <li>• If soap or detergent solutions are used, rinse thoroughly to prevent filmy residue.</li> <li>• Dry with a soft cloth.</li> </ul>
<b>Cast-iron surface units</b>	<p>Warm, soapy water and a sponge</p> <p>Soapy, nonabrasive scrubbing pad or scouring powder</p> <p>Salt-free oil on a paper towel</p> <p>Electrol® dressing</p>	<ul style="list-style-type: none"> <li>• Clean when cooktop and surface units are cool.</li> <li>• Wipe off the surface units after each use.</li> </ul> <p><b>NOTE:</b> After each cleaning, heat surface units until dry.</p> <p><b>To darken surface units or to remove rust spots:</b></p> <ul style="list-style-type: none"> <li>• Make sure surface units are cool.</li> <li>• After each cleaning, apply <b>thin</b> coat of oil to surface units, then heat for 3-5 minutes. Slight smoking of oil will occur.</li> <li>• Follow the directions on the dressing.</li> </ul> <p><b>NOTE:</b> Oil and dressing will improve surface unit appearance, but will not eliminate dark spots caused by grease and food.</p>
<b>Trim rings (with oxide coating)</b>	<p>Sponge and warm, soapy water or paper towel and spray glass cleaner</p> <p>Soapy, nonabrasive scrubbing pad</p> <p><b>DO NOT</b> use a soapy steel-wool pad</p>	<ul style="list-style-type: none"> <li>• Clean when cooktop and surface units are cool.</li> </ul>

# Electric Ceramic Cooktop with Radiant/Halogen Surface Units

## Use

In This Section		Page	Page
Power on/hot surface lights .....	16	Control setting guide .....	16
Surface unit markers .....	16	The ceramic cooktop .....	17

The ceramic cooktop features a smooth, streamlined surface for ease of cooking and cleaning. However, because ceramic cooktops operate differently than standard coil surface unit cooktops, you should review this section carefully for proper use.

### Power on/hot surface lights

One of the Power On/Hot Surface Lights on the control panel glows when a surface unit is turned on or is hot. The top light works with the rear surface unit, while the bottom light works with the front surface unit.

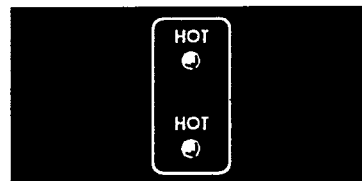

### Surface unit markers

The solid dot in the surface unit marker shows which surface unit is turned on by that knob.

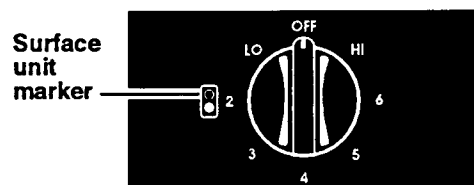

### Control setting guide

#### **⚠ WARNING**

##### **Burn and Fire Hazard**

Be sure both control knobs are turned to OFF and the Power On/Hot Surface Lights are OFF when you are not cooking.

Someone could be burned or a fire could start if a surface unit is accidentally left ON.



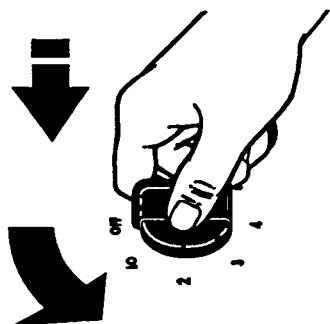

Push in controls before turning to a setting. You can set them anywhere between HI and OFF.

Until you get used to the settings, use the chart at right as a guide. For best results, start cooking at the high setting; then turn the control knob down to continue cooking.

SETTING	RECOMMENDED USE
HI	<ul style="list-style-type: none"> <li>To start foods cooking.</li> <li>To bring liquids to a boil.</li> <li>Turn to LO or 3-2 when sizzle starts.</li> </ul>
6-5	<ul style="list-style-type: none"> <li>To hold a rapid boil.</li> <li>To fry chicken or pancakes.</li> <li>Turn to LO or 3-2 when sizzle starts.</li> </ul>
4	<ul style="list-style-type: none"> <li>For gravy, pudding and icing.</li> <li>To cook large amounts of vegetables.</li> <li>Turn to LO to finish cooking.</li> </ul>
3-2	<ul style="list-style-type: none"> <li>To keep food cooking after starting it on a higher setting.</li> </ul>
LO	<ul style="list-style-type: none"> <li>To keep food warm until ready to serve.</li> </ul>

## The ceramic cooktop

Cooking on the ceramic cooktop is almost the same as cooking on standard surface units. There are, however, a few differences:

- **The ceramic cooktop** takes slightly longer to heat up than a regular surface unit. It also takes a little longer to cool down.
- **The surface unit glows** red when it is turned on. You will see the element cycling on (glowing red) and off to maintain the proper temperature setting you selected.
- **The rear surface unit features** a halogen element. This element also lights up as soon as you turn it on, and is brighter than standard coil surface units.
- **Do not use** the cooktop for heating large quantities of water or other liquids (over 6 quarts).
- **Do not use** the ceramic cooktop for canning.
- **Sliding metal pans** on the ceramic cooktop surface could leave marks. Clean metal marks using the Cooktop Polishing Creme included with the cooktop. **Remove these marks before using the cooktop again.** Wiping off the cooktop after each use helps keep the surface free from stains and provide the most even heating. See pages 18-20 for care and cleaning suggestions.
- **With your hand,** feel the bottom of your pans while they are cool for nicks and scratches. Nicks and scratches on pan bottoms can scratch the ceramic cooktop.



## Caring for Your Electric Ceramic Cooktop

# Care

In This Section		Page	Page
Control knobs .....	18	Cleaning chart .....	20
Ceramic cooktop and control panel .....	18		

Your cooktop is designed for easy care. You can do most cleaning with items found around your home. Cleaning your cooktop whenever spills or soiling occurs helps to keep it looking and operating like new.

### ⚠ WARNING

#### Burn and Electrical Shock Hazard

Make sure all controls are OFF and the cooktop is cool before cleaning. Do not allow moisture to collect in control area when cleaning.

Failure to do so could result in burns or electrical shock.

## Control knobs

1. **Make** sure all control knobs are turned to OFF.
2. **Pull** the control knobs straight off.
3. **Wash** control knobs with sponge and warm, soapy water. **Rinse** well and **dry** with a soft cloth. Do not soak.
4. **Replace** control knobs by pushing them firmly into place.

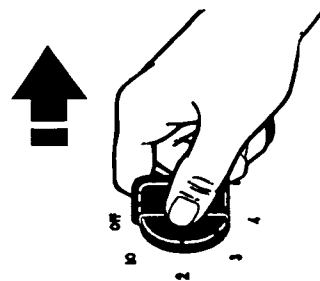

#### NOTES:

- **When cleaning**, never use steel wool, abrasives, or commercial oven cleaners which may damage the finish. After cleaning, make sure all control knobs point to OFF.
- **To prevent moisture** from collecting in control area, do not remove seals under control knobs. Wipe up spills in control area as soon as they occur.

## Ceramic cooktop and control panel

This cooktop is designed for easy care. However, ceramic cooktops need to be maintained differently than standard electric coil surface units. Foods spilled directly on the cooktop will not burn off as on coil surface units. Because of this, the surface should be dust-free and soil-free before heating.



## **⚠ WARNING**

### **Personal Injury Hazard**

- When removing heavy or sugary spills from the hot cooktop, wear oven mitts.
- Do not use cooktop cleaner on a hot cooktop. The cleaner could produce hazardous fumes or damage the cooktop.
- Do not use the cooktop if cracked or broken.

Failure to follow these instructions could result in personal injury.

### **To avoid damaging the cooktop, follow these instructions:**

- Remove sugary spills before cooktop cools to prevent pitting.
- Do not use the cooktop as a cutting board.
- Do not allow anything that may melt (such as plastic or aluminum foil) to come in contact with the surface while it is hot.
- Do not use the ceramic cooktop to cook popcorn that comes in prepackaged aluminum containers. The container could leave aluminum marks on the cooktop that cannot be removed completely.
- Do not use steel wool, plastic cleaning pads, abrasive powdered cleansers, chlorine bleach, rust remover, ammonia or glass cleaning products with ammonia. These could damage the cooktop surface.
- Dropping heavy or hard objects on the cooktop can crack it. Be careful with heavy skillets. Do not store jars or cans above the cooktop.

Your cooktop is prepolished at the factory for improved protection and cleanability. The Cooktop Polishing Creme (included with your cooktop), paper towels or a sponge and a single-edge razor blade in a holder are all you need to clean your cooktop glass. For proper

cleaning methods, please review “Cleaning tips” below and the “Cleaning chart” on page 20. Following them after each use will ensure top performance and preserve that uniquely elegant look.

## **Cleaning tips**

### **What to use:**

- **Cooktop Polishing Creme with paper towel or clean, damp sponge**—This creme is designed to clean and protect your cooktop. When using, follow instructions on container.
- **Single-edge razor blade in a holder**—Use to remove cooked-on soils. Razor blades will not scratch your cooktop glass. **Store razor blades out of reach of children.**

### **Steps to follow:**

1. **Wipe up** most spills as soon as Power On/ Hot Surface Light(s) go off. Use a paper towel or clean, damp sponge.
2. **Rub Cooktop Polishing Creme** into cooked-on soil using a paper towel. If some soil remains, leave some creme on the spot(s) and follow Step 3.
3. Carefully **scrape** spots with a single-edge razor blade in a holder.
4. **Polish** entire cooktop with Cooktop Polishing Creme and a paper towel.

### **Additional tips:**

- **Make sure bottoms** of pans are clean and dry before using.
- **Avoid spillovers.** Use pans with tall sides.
- **Do not cook food** directly on ceramic cooktop.

### **To order Cooktop Polishing Creme (Part No. 3184477), write to:**

KitchenAid  
Parts Distribution Center  
123 Koomler Drive  
LaPorte, IN 46350

**OR**

Call 1-800-422-1230 to order. You must have a major credit card to order by phone.

## Cleaning chart

Use this chart for proper and effective cleaning of your ceramic cooktop.

PART	TYPES OF SOIL OR MARKS	WHAT TO USE	HOW TO CLEAN
Control knobs		Warm, soapy water and a sponge	<ul style="list-style-type: none"> <li>• Wash, rinse and dry well.</li> <li>• Do not soak.</li> <li>• <b>Do not remove seals under control knobs.</b></li> </ul>
Ceramic cooktop	Sugar spills and soils (such as jellies and candy syrups)	Paper towel or clean, damp sponge Cooktop Polishing Creme Single-edge razor blade in a holder	<ul style="list-style-type: none"> <li>• See "Steps to follow" on page 19. Sugar spills and soils can cause pitting on the cooktop if not removed <b>while the ceramic surface is still warm</b>. Remove as soon as possible after the spill occurs.</li> </ul>
	Dark streaks, specks and discoloration	Cooktop Polishing Creme	<ul style="list-style-type: none"> <li>• Rub Cooktop Polishing Creme into spots using a paper towel.</li> </ul>
	Metal marks (from copper or aluminum pans)	Cooktop Polishing Creme	<ul style="list-style-type: none"> <li>• Rub Cooktop Polishing Creme into spots using a paper towel. Metal marks should be removed before heating the cooktop again. If heated before cleaning, metal marks may not come off.</li> </ul>
	Tiny scratches or abrasions	Cooktop Polishing Creme	<ul style="list-style-type: none"> <li>• Tiny scratches or abrasions do not affect cooking. In time, these will become less visible as a result of cleaning. To prevent scratches and abrasions, use Cooktop Polishing Creme regularly.</li> </ul>

**NOTE:** Use a nonabrasive cleanser with a clean, damp paper towel or sponge as an alternative method for removing cooked-on soils. Always rinse and dry your cooktop thoroughly after using cleanser to prevent streaking or staining.

# Gas Cooktop with Sealed Burners

## Use

In This Section	Page	Page	
Surface burner markers .....	21	Surface burners .....	22
Control setting guide .....	21		

Your gas cooktop with sealed burners provides you with even heat and a clean, modern look. For the most effective cooking, please read the following instructions.

### Surface burner markers

The solid dot in the surface burner marker shows which surface burner is turned on by that knob.

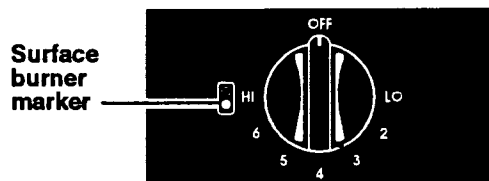

### Control setting guide

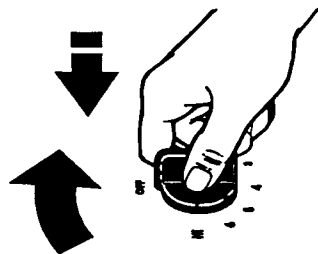

Push in controls before turning to a setting. You can set them anywhere between HI and OFF.

Until you get used to the settings, use the chart at right as a guide. For best results, start cooking at the high setting; then turn the control knob down to continue cooking.

**NOTE:** Cooking times may need to be adjusted when using a vent system with your gas cooktop.

SETTING	RECOMMENDED USE
HI	<ul style="list-style-type: none"> <li>To start foods cooking.</li> <li>To bring liquids to a boil.</li> <li>Turn to LO or 3-2 when sizzle starts.</li> </ul>
6-5	<ul style="list-style-type: none"> <li>To hold a rapid boil.</li> <li>To fry chicken or pancakes.</li> <li>Turn to LO or 3-2 when sizzle starts.</li> </ul>
4	<ul style="list-style-type: none"> <li>For gravy, pudding and icing.</li> <li>To cook large amounts of vegetables.</li> <li>Turn to LO to finish cooking.</li> </ul>
3-2	<ul style="list-style-type: none"> <li>To keep food cooking after starting it on a higher setting.</li> </ul>
LO	<ul style="list-style-type: none"> <li>To keep food warm until ready to serve.</li> </ul>



# Using Your Gas Sealed Burner Cooktop

## Surface burners

The gas sealed burners have an auto-reignition system. The sealed burners spread heat evenly across the bottom of the cooking utensil and provide infinite heat control. The auto-reignition system senses when a burner flame has gone out and will automatically reignite that burner.

**Your cooktop is factory-set for use with Natural Gas. If you wish to use L.P. gas, L.P. Gas Conversion Kits are available from your authorized KitchenAid dealer or parts outlet. Use Kit No. 4175444 for Model KGCT025Y. Use Kit No. 4175463 for Model KGCT025A. In all cases, the conversion must be done by a qualified service technician.**

### When to use the rear burner:

Use this burner for cooking large quantities of food, deep-fat frying or cooking with a large cooking utensil.

### When to use the front burner:

Use this burner for simmering or for cooking smaller quantities of food requiring a small cooking utensil.

### How to use the surface burners:

1. **Grasp** the control knob.
2. **Push down and turn** to the left to HI. The electric spark ignitor will ignite the gas flowing into the burner. When you hear a clicking sound, you know that the ignitors are working. Gas is flowing as long as the control knob is not set at OFF.
3. **When the burner is lit**, turn the control knob to the left to the desired flame setting. (See guide on page 21.) The ignitor will turn off and the clicking will stop when the burner ignites.

#### NOTES:

- The ignitors may click a number of times

before the burner lights. This is normal.

- **Both burner ignitors will spark regardless of which burner you are using.**
- **Visually check that burner has lit.** If the burner does not ignite, listen for the clicking sound. If you do not hear the ignitor click, **TURN THE BURNER OFF.** Check that the service cord is firmly in place in the wall receptacle. Check for a tripped circuit breaker or blown fuse. Check that the control knob is pressed completely down on valve shaft. **If the spark ignitor still fails to operate, call your nearest authorized KitchenAid service company.**

Proper grounding and polarity is necessary for correct operation of the electric ignition system. If the wall receptacle does not provide correct polarity, the ignitor will become grounded and click every once in a while, even after the burner has ignited. A qualified electrician should check the wall receptacle to see if it is wired with correct polarity.

- **Do not use** this gas sealed burner cooktop for canning.

## ⚠ WARNING

### Burn, Fire and Explosion Hazard

- Burner flame should not extend beyond the edge of the cooking utensil. The flame could burn you and cause poor cooking results.
- Be sure both control knobs are turned to OFF when you are not cooking. Someone could be burned or a fire could start if a burner is accidentally left on.
- If the flame should go out while cooking, or if there is a strong gas odor, turn the burners off. Wait five minutes for the gas odor to disappear before relighting burner. If gas odor is still present, see safety note on page 3. Failure to follow these precautions could result in explosion or fire.

# Caring for Your Gas Sealed Burner Cooktop

## In case of a prolonged power failure

Surface burners can be manually lighted.

1. **Hold** a lighted match near a burner and turn the control knob to HI.
2. **After the burner lights, turn** the control knob to the desired setting.

## NOTES:

- **Be careful** when lighting burner. The flame can burn you.
- **Do not leave** cooktop unattended when cooking during a power failure. The auto-reignition feature of your cooktop will not operate during a power failure.

# Care

In This Section		Page	Page
Control knobs .....	24	Gas sealed burners .....	25
Tempered glass surface .....	24	Cleaning chart .....	27

Your cooktop is designed for easy care. You can do most cleaning with items found around your home. Cleaning your cooktop whenever spills or soiling occurs helps to keep it looking and operating like new.

## **⚠ WARNING**

### **Burn, Electrical Shock, Fire, Explosion and Product Damage Hazard**

- Make sure all controls are OFF and the cooktop is cool before cleaning.
  - Do not use oven cleaners, bleach or rust removers.
  - Do not obstruct the flow of combustion and ventilation air.
  - If knobs are removed while cleaning, be careful not to spill liquids through holes in the control area.
  - Be careful not to allow moisture to collect in control area. Moisture can cause ignitor switches to fail.
  - Keep appliance area clear and free of combustible materials, gasoline and other flammable vapors and liquids.
- Failure to follow these guidelines could result in burns, electrical shock, fire, explosion, or product damage.

---

## Control knobs

1. **Make sure** all control knobs are turned to OFF.
2. **Pull** the control knobs straight off.
3. **Wash** control knobs with sponge and warm, soapy water. **Rinse** well and **dry** with a soft cloth. Do not soak.
4. **Replace** control knobs by pushing them firmly into place.

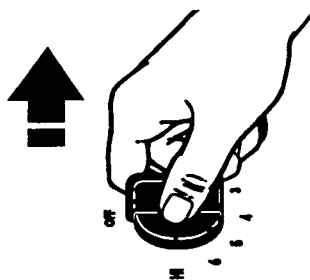

### NOTES:

- **When cleaning**, never use steel wool, abrasives, or commercial oven cleaners which may damage the finish. After cleaning, make sure all control knobs point to OFF.
- **To prevent moisture** from collecting in control area, do not remove seals under control knobs. Wipe up spills in control area as soon as they occur. Moisture can cause the ignitor switches to fail.

---

## Tempered glass surface

1. **Wipe** with sponge and warm, soapy water or paper towel and mild glass cleaner.
2. **Dry** with soft cloth.
3. If soap or detergent solutions are used, **rinse** thoroughly to prevent filmy residue.

### NOTES:

- **When cleaning** cooktop with knobs removed, DO NOT allow water to run down inside unit. When cleaning, never use steel wool, abrasives, or commercial oven cleaners which may damage the finish.
- **When cleaning** the cooktop or the area around the burner base, remove the grate but leave the burner cap in place to protect the ignitor from possible damage. If a cleaning cloth catches the ignitor, it could damage or break the ignitor. If the ignitor is damaged or broken, the surface burner will not light.



---

## Gas sealed burners

### Surface burner grates

1. **Make sure** all surface burners are off and the surrounding parts are cool.

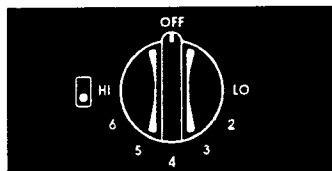

2. **Lift off** the burner grates.

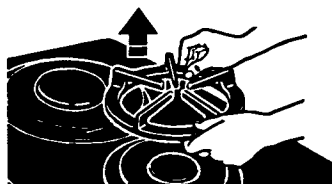

3. **Wash** the grates with warm, soapy water. **Use** a wet, soapy steel-wool pad for heavily soiled areas. **Rinse** and **dry** well. **Do not** place grates in a dishwasher.

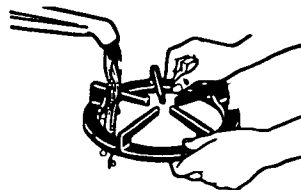

4. **Replace** burner grates.

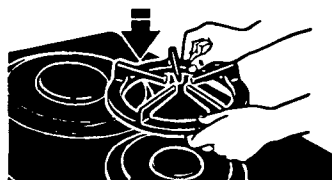

## Caring for Your Gas Sealed Burner Cooktop

### Surface burners

- **The burner caps** should be routinely removed and cleaned. Always clean burner caps after a spillover. Keeping the burner caps clean prevents improper ignition and an uneven flame.
- **For proper flow** of gas and ignition of the burner, **DO NOT ALLOW SPILLS, FOOD, CLEANING AGENTS OR ANY OTHER MATERIAL TO ENTER THE GAS TUBE OPENING.**
- **Gas must flow freely** through the small hole in the brass orifice for the burner to light properly. This area must be free of any soil and be kept protected from boilovers or spillovers. **ALWAYS** keep the burner caps in place whenever a surface burner is in use.
- **Occasionally check** the burner flames for proper size and shape as shown. A good flame is blue in color. If flames lift off ports, are yellow, or are noisy when turned off, you may need to clean the burners.

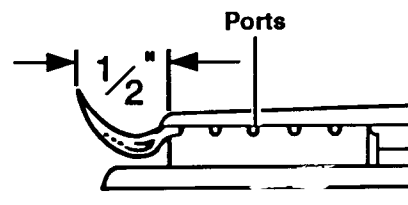

Typical surface burner flame at the highest setting

#### To clean burners:

1. **Lift** the burner cap straight up from the burner base.
2. **Clean** burner cap with warm, soapy water and a sponge. You can also clean with a nonabrasive scrubbing pad or cleanser. Do not clean burner cap in dishwasher.
3. **If the gas tube opening** or the orifice, located inside the opening, has become soiled or clogged, **use** a cotton swab or a soft cloth to clean the area.
4. **If ports are clogged**, clean with a straight pin. **Do not enlarge or distort port. Do not leave anything stuck in the ports.**
5. **After cleaning** the gas tube opening and ports, **replace** the burner cap. **To replace burner cap**, make sure cap is properly aligned and leveled.
6. **Check** the burner after cleaning for proper lighting.

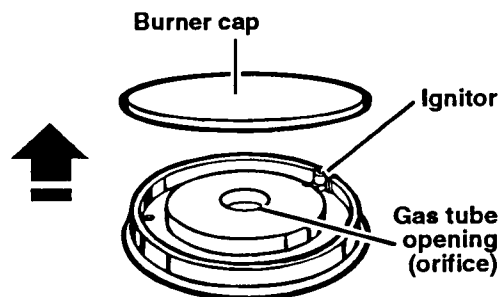

## Cleaning chart

Use this chart for proper and effective cleaning of your sealed burner cooktop.

PART	WHAT TO USE	HOW TO CLEAN
<b>Control knobs</b>	Warm, soapy water and a sponge	<ul style="list-style-type: none"> <li>• Wash, rinse and dry well.</li> <li>• Do not soak.</li> <li>• Do not remove seals under control knobs.</li> </ul>
<b>Tempered glass surface</b>	Sponge and warm, soapy water or paper towel and spray glass cleaner	<ul style="list-style-type: none"> <li>• Wipe off regularly when cooktop is cool.</li> <li>• If soap or detergent solutions are used, rinse thoroughly to prevent filmy residue.</li> <li>• Dry with a soft cloth.</li> </ul>
<b>Gas sealed burners, grates and caps</b>		See pages 25 and 26 for cleaning instructions.

# Electric Grill

## Use

In This Section	Page	Page
Power on lights .....	28	Grill .....28
Grill markers .....	28	

Your electric grill gives you that outdoor flavor in the convenience and comfort of your home. To get the most out of your grill, please review this section carefully.

### Power on lights

One of the Power On Lights on the control panel glows when a grill element is turned on. The back light works with the rear grill element, while the front light works with the front grill element.



### Grill markers

The solid dot in the grill marker shows which grill element (rear or front) is operated by the control knob.

To set the control knob, push in and turn to the desired setting. (See "Grill chart" on page 29 for recommended settings for commonly cooked foods.)

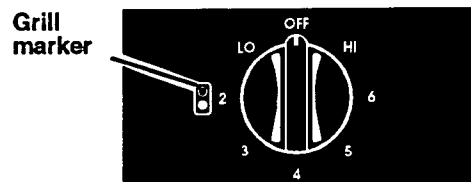

### Grill

#### **⚠ WARNING**

##### **Burn and Fire Hazard**

Be sure both control knobs are turned to OFF and the Power On Lights are OFF when you are not cooking.

Someone could be burned or a fire could start if the grill is accidentally left ON.

Rock pack must be in place during use. This prevents flare-ups.

#### **Before you use the grill for the first time:**

Wash with warm, soapy water and a soft cloth, rinse and dry. You can also use soapy plastic, nylon or wet steel-wool scrubbing pads on the grill; these will not damage the surface.

## Grill chart

Preheat 10 minutes on HI for best results. Then use the chart below to help you select a grill setting and cooking time. Grilling times are approximate and may need to be adjusted to individual tastes.

FOOD	SETTING	GRILLING TIME (in minutes)	
		SIDE 1	SIDE 2
<b>Beef steak (1/2-3/4")</b>			
•rare	HI	5-8	5-6
•medium	HI	10	8
•well-done	HI	14	12
<b>Beef steak (1")</b>			
•rare	HI	8-9	6
•medium	HI	9-11	10
•well-done	HI	15-16	14
<b>Hamburgers</b>	6	20-25*	
<b>Hot dogs</b>	6	10-15*	
<b>Pork chops</b>	6	25-35*	
<b>Spare ribs, barbecued</b>	6	50-60*	
<b>Lamb chops</b>	HI	25-35*	
<b>Chicken pieces</b>	HI	45-60*	
<b>Ham slices</b>	5	20-25*	
<b>Garlic bread</b>	HI	3-5*	

\*Total grilling time. Turn food as needed.

## Cooking tips

- **Do not cover** the entire cooking surface with meat. Leave space between the food items to allow smoke and steam to ventilate properly.

- **Meat with a normally high fat content** will produce more smoke and flare-ups. Trim fat from meat before placing on the grill to prevent excessive smoke or flare-ups.
- **If meat begins to cook too quickly**, turn the grill control knob to a lower setting.
- **Do not leave grill unattended.**
- **Move meat around and turn as needed** for even cooking.
- **Brush on barbecue sauce** during last 5-10 minutes of cooking, if desired.
- **Butter French bread** and sprinkle with garlic salt before grilling.
- **You can use one or both elements**, depending upon the amount of food you are grilling.

**NOTE:** To remove smoke that may be produced, use your vent system (updraft or downdraft). Different vent systems can affect cooking results. Grilling times may need to be adjusted depending on the type of vent system used and the vent fan speed. For example, you may need to extend grilling times when using a downdraft vent system.

## WARNING

### Fire and Product Damage Hazard

Grease can cause excessive flare-ups.

#### To put out fire:

- Turn the grill control knob to OFF and cover the grill with a large metal pan.
- Make sure the vent system has been switched to OFF.
- Do not put water on a grease fire.

# Care

In This Section	Page	Page	
Steps to follow .....	30	Cleaning chart .....	31

Your grill is designed for easy care. You can do most cleaning with items found around your home. Cleaning your grill whenever spills or soiling occurs helps to keep it looking and operating like new.

## Steps to follow

Food cooked on the grill may spatter. Clean all parts of your grill, except the heating element, after each use. A soiled heating element cleans itself by burning off spills and spatters.

**⚠ WARNING**

**Burn and Electrical Shock Hazard**  
Make sure grill is OFF and cool before cleaning. Do not allow moisture to collect in control area when cleaning.  
Failure to do so could result in burns or electrical shock.

### To remove grill:

1. Lift off grate.



2. Lift heating element slightly.
3. Pull heating element away from you to unplug terminal from receptacle.

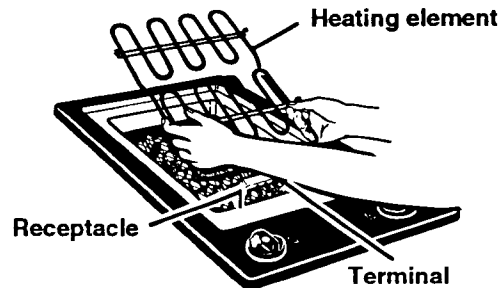

**4. Lift out rock pack.**

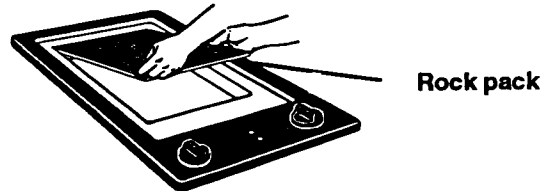

**5. Lift and remove the grease pan, being careful not to spill drippings.**

Wash grate with warm, soapy water and a nonabrasive plastic scrubbing pad. Use a wet, soapy steel-wool pad for heavily soiled areas. Rinse and wipe dry.

Wash the rock pack and grease pan in warm, soapy water. Use a plastic scrubbing pad for heavily soiled areas. Rinse and wipe dry. The grease pan and rock pack may be cleaned in a dishwasher. To remove stains from rocks in rock pack, place in an oven (on oven rack) during the Self-Cleaning cycle.

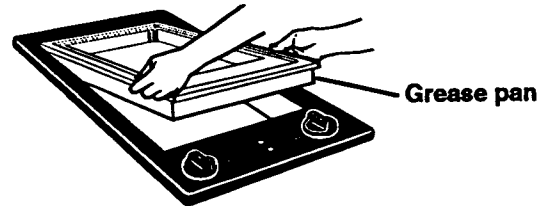

### To replace grill:

1. Lower the grease pan into opening.
2. Put in rock pack.
3. Plug heating element terminal into receptacle.
4. Place grate over heating element.

## Cleaning chart

Use this chart for proper and effective cleaning of your grill.

PART	WHAT TO USE	HOW TO CLEAN
<b>Control knobs</b>	Warm, soapy water and a sponge	<ul style="list-style-type: none"> <li>• Wash, rinse and dry well.</li> <li>• Do not soak.</li> <li>• <b>Do not remove seals under control knobs.</b></li> </ul>
<b>Grate and grease pan</b>	Warm, soapy water and a nonabrasive plastic scrubbing pad	<ul style="list-style-type: none"> <li>• Clean after each use.</li> <li>• Wash, rinse and dry.</li> <li>• Do not use metal scouring pads or harsh cleansers.</li> <li>• Grease pan may be cleaned in a dishwasher.</li> </ul>
<b>Heating element</b>		<ul style="list-style-type: none"> <li>• Do not clean. Do not put element in water. Soil burns off.</li> </ul>
<b>Rock pack</b>	Warm, soapy water and a sponge	<ul style="list-style-type: none"> <li>• Wash, rinse and dry, or place in a dishwasher.</li> <li>• For heavy stains, place in an oven (on oven rack) during the Self-Cleaning cycle. Follow instructions in your oven Use and Care Guide.</li> </ul>

# Side Mount Downdraft Vent System

## Use

Using the cooktop's downdraft vent system removes cooking vapors, odor and smoke. Always turn on the vent fan when using the grill.

When using surface units or burners, turn the Vent Fan control knob clockwise to HI or LO. You will hear a click when the fan comes on. Turn counterclockwise to turn the fan OFF.

The fan filter must be in place for the fan to operate properly.

**NOTE:** Extend cooking times as needed when using the downdraft vent system.

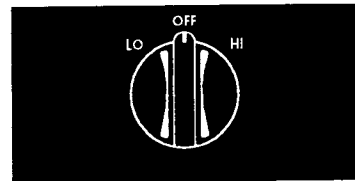

### **⚠ WARNING**

#### **Personal Injury Hazard**

Do not put hands in vent box when fan or controls are on. Turn fan and cooktop controls to OFF.

Failure to do so could result in personal injury.



# Care

In This Section	Page	Page
Steps to follow ..	33	Cleaning chart ..... 34

Your vent system is designed for easy care. You can do most cleaning with items found around your home. Cleaning your vent system regularly will help to keep it operating like new.

## Steps to follow

### **⚠ WARNING**

#### **Personal Injury Hazard**

- Disconnect the electrical supply before servicing the cooktop. The wall receptacle is located in the cabinet beneath the cooktop.
- Turn fan and cooktop controls to OFF before cleaning the vent system. Do not put hand in vent box when fan or controls are on.

Failure to follow these instructions could result in personal injury.

1. **Remove** the vent cover and **wash** in warm, soapy water or **wipe** with a damp sponge. **Do not use metal scrubbing pads or abrasive cleansers.**
2. **Lift up** vent filter, which is directly below vent cover. **Wash** in warm, soapy water or dishwasher.  
**NOTE:** Use care when washing the vent filter in a dishwasher. Do not place vent filter near hard or sharp objects that could cause the filter to bend.
3. **Wipe** in and around the vent box with a damp cloth. **Clean up** spills with a sponge.
4. **Replace** the vent filter. **Be sure** the vent filter is replaced flat and rests on side edges of trim. Do not replace vent filter at an angle.
5. **Replace** the vent cover.

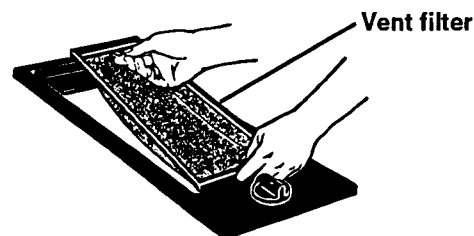
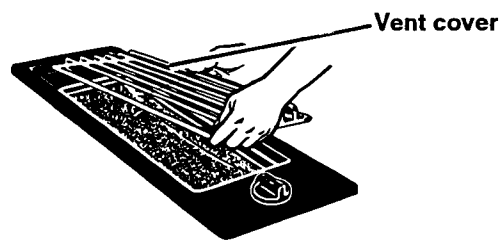



## Caring for Your Downdraft Vent System

**NOTE:** Vent filter must be in place for the fan to operate properly. Replacement filters can be ordered from a KitchenAid servicer or dealer. Order Part Number 4173617 (chrome) or 4173618 (black).

If you are unable to obtain the name of a local authorized KitchenAid servicer, call our toll-free Consumer Assistance Center telephone number **1-800-422-1230**.

---

### Cleaning chart

Use this chart for proper and effective cleaning of your vent system.

PART	WHAT TO USE	HOW TO CLEAN
<b>Control knob</b>	Warm, soapy water and a sponge	<ul style="list-style-type: none"><li>• Wash, rinse and dry well.</li><li>• Do not soak.</li><li>• <b>Do not remove seal under control knob.</b></li></ul>
<b>Cover and filter</b>	Warm, soapy water and a sponge; or a dishwasher	<ul style="list-style-type: none"><li>• Clean often.</li><li>• Wash, rinse and dry well.</li></ul>
<b>Vent box</b>	Warm, soapy water and a sponge	<ul style="list-style-type: none"><li>• Clean often.</li><li>• Wipe out grease residue with a paper towel. Sponge out spills.</li></ul>

# If You Need Assistance or Service

If you ever have questions or comments about your appliance, you can call our toll-free Consumer Assistance Center telephone number, 1-800-422-1230, 24 hours a day.

This section is designed to help you save the cost of a service call. Part 1 of this section outlines possible problems, their causes, and actions you can take to solve each problem. Parts 2 and 3 tell you what to do if you still need assistance or service. When calling our Consumer Assistance Center for help or calling for service, please provide a detailed description of the problem, your appliance's complete model and serial numbers and the purchase or installation date. (See page 2.) This information will help us respond properly to your request.

## 1. Before calling for service ...

If your appliance should fail to operate, review the following list before calling your dealer. You could save the cost of a service call.

PROBLEM	POSSIBLE CAUSE	WHAT TO DO
<b>Nothing operates</b>	The cooktop is not properly connected to electrical and gas (for gas sealed burner cooktop) supplies.	Contact an authorized KitchenAid servicer to reconnect cooktop to electrical and/or gas supply. (See Installation Instructions.)
	Your home's main fuses have blown or circuit breaker has tripped.	Replace fuse or reset circuit breaker. <b>Gas sealed burner cooktop:</b> In case of prolonged power failure, manually light burners. (See page 23.)
	The control knob is not set in the correct position.	Reset control knob, if needed.
	On downdraft vent system, the flow of combustion and/or ventilation air to the unit is obstructed. <b>Do not obstruct airflow to and around unit.</b>	Remove blockage to airflow to and around cooktop.  Review instructions in this book to make sure you have followed them correctly.
<b>Surface units will not operate or burner fails to light</b>	The cooktop is not connected to electrical power.	Contact an authorized KitchenAid servicer to reconnect cooktop to electrical supply. (See Installation Instructions.)

continued on next page



## If You Need Assistance or Service

PROBLEM	POSSIBLE CAUSE	WHAT TO DO
<b>Surface units will not operate or burner fails to light (continued)</b>	Your home's main fuses have blown or circuit breaker has tripped.	Replace fuse or reset circuit breaker. <b>Gas sealed burner cooktop:</b> In case of prolonged power failure, manually light burners. (See page 23.)
	The control knobs cannot be turned.	Call a KitchenAid servicer if repair is needed.
	The burner ports are clogged (gas sealed burner cooktop).	Clean with a straight pin. (See page 26.)
<b>Burner flames are uneven</b>	The burner ports are clogged.	Clean with a straight pin. (See page 26.) If this fails, call an authorized KitchenAid servicer.
<b>Burner flames lift off ports, are yellow, or are noisy when turned off</b>	Air/gas mixture may be incorrect.	Contact an authorized KitchenAid servicer to check air/gas mixture.
<b>Burner makes a popping noise when on</b>	The burner is wet from washing.	Let dry.
<b>Burners spark</b>	<p>It is normal for all four burners to spark briefly when:</p> <ul style="list-style-type: none"> <li>• A burner is turned on, but has not yet ignited.</li> <li>• There is a draft blowing on burners.</li> <li>• A very large pot on burner causes flame to be unstable.</li> </ul> <p>Continuous sparking may be caused when:</p> <ul style="list-style-type: none"> <li>• A spillover has wet ignition switch contacts.</li> <li>• There is a faulty spark module.</li> <li>• The wall outlet wiring is incorrect.</li> </ul>	<p>No action is needed. Burner operation is not affected and the sparking should end when the ignited flame is burning undisturbed.</p> <p>Turn on one or two burners or disconnect electrical supply to let switch dry out.</p> <p>Contact a service technician to replace module.</p> <p>Check with a ground fault plug-in light. Contact a qualified electrician to correct wiring, if needed.</p>

## If You Need Assistance or Service

PROBLEM	POSSIBLE CAUSE	WHAT TO DO
<b>Control knob(s) will not turn</b>	You did not push in before trying to turn.	Turn knob(s) again, pushing down as you turn.
<b>Venting results are not what you expected</b>	The exhaust fan is not turned on.	Turn the vent fan control knob clockwise to turn it on.
	The cooktop surface burners/ units and component parts are not clean.	Clean after each use. (See "Care" sections in this manual.)
	Vent filter is not clean and in place.	Clean and replace vent filter. (See page 33.)
	Vent duct or outside opening is blocked.	Remove blockage from vent duct or outside opening. Call KitchenAid servicer if help is needed.
	Vent duct fan run is too long.	Check duct run installation and correct if not done according to Installation Instructions.
	There is a draft in the room where the cooktop is installed.	Find source of draft and close it off.
	The meat fat is not well trimmed, which can cause excessive smoking.	Trim fat off of meat and remove from pan.

continued on next page



## If You Need Assistance or Service

<b>PROBLEM</b>	<b>POSSIBLE CAUSE</b>	<b>WHAT TO DO</b>
<b>Cooking results are not what you expected</b>	The cooktop is not level.	See Installation Instructions for information on how to level cooktop.
	On gas sealed-burner cooktop, the flame size does not fit the cooking utensil being used.	Adjust flame size to fit cooking utensil.
	You are not following a tested recipe from a reliable source.	Modify recipe or find a new recipe.
	The pans are not the size called for in the recipe.	Replace pans with correct-size pans.
	The cooking utensils do not have smooth, flat bottoms or fit the surface burners/units being used.	Use cooking utensils with smooth, flat bottoms that fit the surface burners/units being used.
	On grill, you have not left space between the food items.	Reposition food items to create more space between them.
	The grill was not preheated for the proper amount of time.	Leave food on grill longer. Remember to preheat grill the next time you use it.
	Both elements were not turned on when necessary.	Turn on both burners when grilling larger amounts of food.
Food was partially frozen or very cold before grilling.	Leave food on grill longer.	

## 2. If the problem is not due to one of the items listed in Step 1:

- Call KitchenAid Consumer Assistance Center:

**1-800-422-1230**

One of our trained consultants can instruct you in how to obtain satisfactory operation from your appliance or, if service is necessary, recommend a qualified service company in your area.

- If you prefer, write to:

Consumer Assistance Center  
KitchenAid  
P.O. Box 558  
St. Joseph, MI 49085-0558

Please include a daytime phone number in your correspondence.

## 3. If you need service:

- Call your dealer or the repair service he recommends.
- All service should be handled locally by the dealer from whom you purchased the unit or an authorized KitchenAid servicer.
- If you are unable to obtain the name of a local authorized KitchenAid servicer, call our Consumer Assistance Center telephone number (see Step 2).

## 4. If you are not satisfied with the action taken:

- Contact the Major Appliance Consumer Action Panel (MACAP). MACAP is a group of independent consumer experts that voices consumer views at the highest levels of the major appliance industry.
- Contact MACAP only when the dealer, authorized servicer and KitchenAid have failed to resolve your problem.

Major Appliance Consumer Action Panel  
20 North Wacker Drive  
Chicago, IL 60606

- MACAP will in turn inform us of your action.

### **Don't forget, KitchenAid offers a full line of quality home appliances.**

Built-in Refrigerators	Trash Compactors	Ranges & Cooktops
Freestanding Refrigerators	Hot Water Dispensers	Microwave Ovens
50-Pound Ice Makers	Food Waste Disposers	Washers & Dryers
Dishwashers	Built-in Ovens	Mixers & Blenders

For more information on these appliances, or the one you have purchased, call our toll-free Consumer Assistance Center telephone number, 1-800-422-1230.

# KitchenAid<sup>®</sup>

## Cooktop

# Warranty

LENGTH OF WARRANTY:	KITCHENAID WILL PAY FOR:	KITCHENAID WILL NOT PAY FOR:
<b>ONE YEAR FULL WARRANTY FROM DATE OF INSTALLATION.</b>	Replacement parts and repair labor costs to correct defects in materials or workmanship. Service must be provided by an authorized KitchenAid servicing outlet.	<b>A. Service calls to:</b> <ol style="list-style-type: none"> <li>1. Correct the installation of the cooktop.</li> <li>2. Instruct you how to use the cooktop.</li> <li>3. Replace house fuses or correct house wiring.</li> <li>4. Correct house plumbing.</li> </ol> <b>B. Repairs when cooktop is used in other than normal home use.</b> <b>C. Damage resulting from accident, alteration, misuse, abuse, improper installation or installation not in accordance with local electrical or plumbing codes.</b> <b>D. Any labor costs during the limited warranty.</b> <b>E. Replacement parts or repair labor costs for units operated outside the United States.</b> <b>F. Pickup and delivery. This product is designed to be repaired in the home.</b> <b>G. Repairs to ceramic cooktop if it has not been cared for as recommended in this Use and Care Guide.</b> <b>H. Repairs to parts or systems caused by unauthorized modifications made to the appliance.</b>
<b>SECOND THROUGH FIFTH YEAR LIMITED WARRANTY FROM DATE OF INSTALLATION.</b>	Replacement parts for any electric element or gas burner if defective in materials or workmanship.  Replacement ceramic glass if breakage is due to defects in materials or workmanship.  For downdraft vent system, replacement parts for the downdraft vent motor to correct defects in materials or workmanship.	

593

**KITCHENAID DOES NOT ASSUME ANY RESPONSIBILITY FOR INCIDENTAL OR CONSEQUENTIAL DAMAGES.** Some states do not allow the exclusion or limitation of incidental or consequential damages, so this exclusion or limitation may not apply to you.

This warranty gives you specific legal rights, and you may also have other rights which vary from state to state.

If you need service, first see the "Assistance or Service" section of this book. After checking "Assistance or Service," additional help can be found by calling our Consumer Assistance Center telephone number, 1-800-422-1230, from anywhere in the U.S.A.

KitchenAid  
St. Joseph, Michigan, U.S.A. 49085



Printed on recycled paper –  
10% post consumer waste  
50% recovered materials

Part No. 3186516  
©1993 KitchenAid

® Registered Trademark/TM Trademark of KitchenAid.

Printed in U.S.A.



## Free Manuals Download Website

<http://myh66.com>

<http://usermanuals.us>

<http://www.somanuals.com>

<http://www.4manuals.cc>

<http://www.manual-lib.com>

<http://www.404manual.com>

<http://www.luxmanual.com>

<http://aubethermostatmanual.com>

Golf course search by state

<http://golfingnear.com>

Email search by domain

<http://emailbydomain.com>

Auto manuals search

<http://auto.somanuals.com>

TV manuals search

<http://tv.somanuals.com>