

KitchenAid[®]

*Electric 27" Built-In
Thermal-Convection™
Single and Double Self-Cleaning Ovens*

Models KEBS277X and KEBS177X

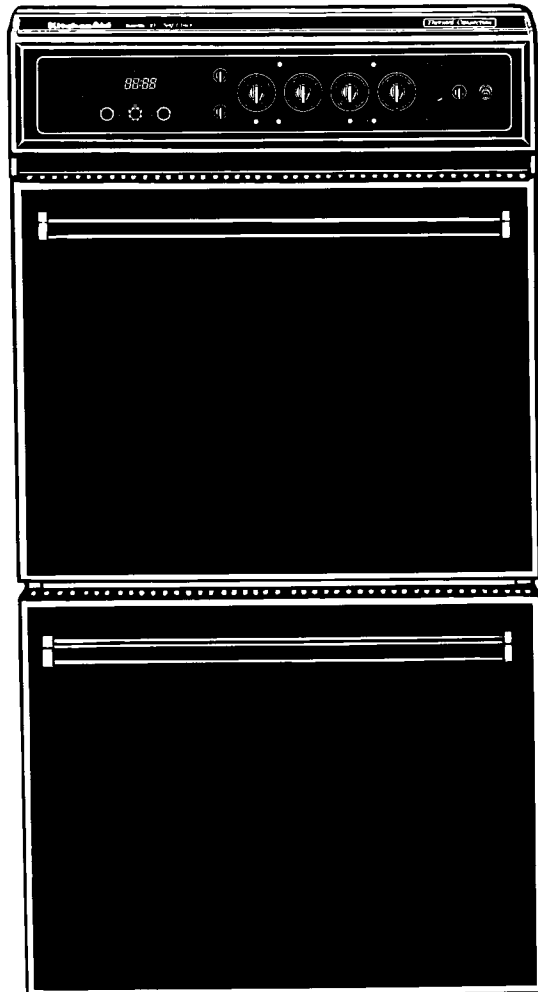

USE and CARE GUIDE

Table of Contents

	Page
Important Safety Instructions	3-4
You Are Responsible For	4
Ownership Registration	5
Built-In Oven Features	6-8
About Convection Ovens	8
Using the Oven	9-19
Electronic Clock Operation	9
Lower Oven Controls	10
Single/Upper Oven Controls	10
Rack Positions	12
Rack and Pan Placement	12
Using Aluminum Foil in the Oven	13
Baking or Convection Baking	14
Dehydrating	14
Roasting or Convection Roasting	15
Temperature Probe	16
Broiling	17
Convection Broiling	17
Automatic Time Cooking	18
Care and Cleaning	20
Control Knobs	20
Glass Surfaces	20
Porcelain Surfaces	20
Chrome Surfaces and Trim	20
Broiler Pan	20
Oven Racks	20
Temperature Probe	20
Self-Clean Oven Cycle	20
Adjusting the Temperature Control	24
Oven Lights – Operation/Replacement ..	25
Optional Oven Door Fronts	26
Removing and Replacing an Oven Door	26
For Service or Assistance	27
KitchenAid Warranty	Back Cover

Your purchase of a KitchenAid Thermal-Convection™ Oven allows you to expand your present methods of cooking and at the same time experience a new and exciting way of increasing the quality of food prepared. The convection oven is a thermal oven with a fan that circulates heated air over food causing the food to cook faster and become evenly browned. This circulating air allows you to reduce oven temperature and baking times. Also, larger quantities of food can be baked at one time, thus saving time and energy. The oven gives you the added convenience of dehydrating foods, too.

A cookbook is provided with your oven. Along with many recipes, the cookbook contains charts showing recommended cooking times and temperatures for both standard and convection ovens. It also contains a section on adapting your favorite standard oven recipes to convection cooking, and valuable information on dehydrating foods in your convection oven.

© 1990 KitchenAid

Important Safety Instructions

⚠ WARNING

To reduce the risk of fire, electrical shock, injury to persons, or damage when using the oven, follow basic precautions, including the following:

1. Read all instructions before using the oven.
2. Install or locate the oven only in accordance with the provided Installation Instructions. It is recommended that the oven be installed by a qualified installer. The oven must be properly connected to electrical supply and grounded.
3. Do not operate the oven if it is not working properly, or if it has been damaged.
4. Do not use the oven for warming or heating the room. Persons could be burned or injured, or a fire could start.
5. Use the oven only for its intended use as described in this manual.
6. Do not wear loose or hanging garments when using the oven. They could ignite if they touch a heating element and you could be burned.
7. Do not touch heating elements or interior surfaces of oven. Heating elements may be hot even though they are dark in color. Interior surfaces of an oven become hot enough to cause burns. During and after use, do not touch, or let clothing or other flammable materials contact heating elements or interior surfaces of oven until they have had sufficient time to cool. Other surfaces of the oven may become hot enough to cause burns; such as, the oven vent opening, the surface near the vent opening, the oven door and the oven door window.
8. Use only dry potholders. Moist or damp potholders on hot surfaces may result in burns from steam. Do not let potholder touch hot heating elements. Do not use a towel or bulky cloth for a potholder. They could catch on fire.
9. Do not heat unopened containers. They could explode. The hot contents could cause burns and container particles could cause injury.
10. Grease is flammable and should be handled carefully. Let fat cool before attempting to handle it.
11. Do not use water on grease fires. Never pick up a flaming pan. Smother flaming pan by covering with a well-fitted lid, cookie sheet or flat tray. Flaming grease outside of pan can be extinguished with baking soda or, if available, a multipurpose dry chemical or foam-type extinguisher.
12. Use care when opening oven door. Let hot air or steam escape before removing or replacing food.
13. Always position oven rack(s) in desired location while oven is cool. If rack must be moved while oven is hot, do not let potholder contact hot heating element in oven.
14. Do not store flammable materials in or near the oven. They could explode or burn.
15. Do not store things children might want above the oven. Children could be burned or injured while climbing on it.

continued on next page

16. Do not leave children alone or unattended in area where the oven is in use. They should never be allowed to sit or stand on any part of the oven. They could be burned or injured.
17. Keep oven vents unobstructed.
18. Clean your oven regularly. See care and cleaning instructions in this manual.
19. Be sure all oven parts are cool before cleaning.
20. Do not clean door gasket. It is essential for a good seal. Care should be taken not to rub, damage, or move the gasket. Clean only parts recommended in this Use and Care Guide.
21. Do not use oven cleaners. No commercial oven cleaner or oven liner protective coating of any kind should be used in or around any part of the oven.
22. Before self-cleaning the oven, remove broiler pan, broiler grid, oven racks and other utensils. Do not use your oven to clean miscellaneous parts.
23. Do not repair or replace any part of the oven unless specifically recommended in this manual. All other servicing should be referred to a qualified technician.
24. Disconnect the electrical supply before servicing the oven.

FOR YOUR SAFETY

DO NOT STORE OR USE GASOLINE OR OTHER FLAMMABLE VAPORS AND LIQUIDS IN THE VICINITY OF THIS OR ANY OTHER APPLIANCE. THE FUMES CAN CREATE A FIRE HAZARD OR EXPLOSION.

SAVE THESE INSTRUCTIONS

You are Responsible For

- Installing the oven where it is protected from the elements, and in a wall or cabinet strong enough to support its weight. (See the Installation Instructions.)
- Making sure the oven is not used by anyone unable to operate it properly.
- Properly maintaining the oven.
- Using the oven only for jobs expected of a home oven.

Ownership Registration

Please fill out and mail your Ownership Registration Card packed with the product. This card will enable us to contact you in the unlikely event of a product safety notification and assist us in complying with the provisions of the Consumer Product Safety Act. Return of this card is not necessary to validate your warranty.

You must provide proof of purchase or installation date for in-warranty service.

Write down the following information. You will need it if your oven ever requires service.

Model Number* _____

Serial Number* _____

Date Purchased _____

Date Installed _____

Builder's or Dealer's Name _____

Address _____

Phone _____

*Model and serial numbers are located on the lower left side of the door opening on the single/upper oven.

Built-In Oven Features

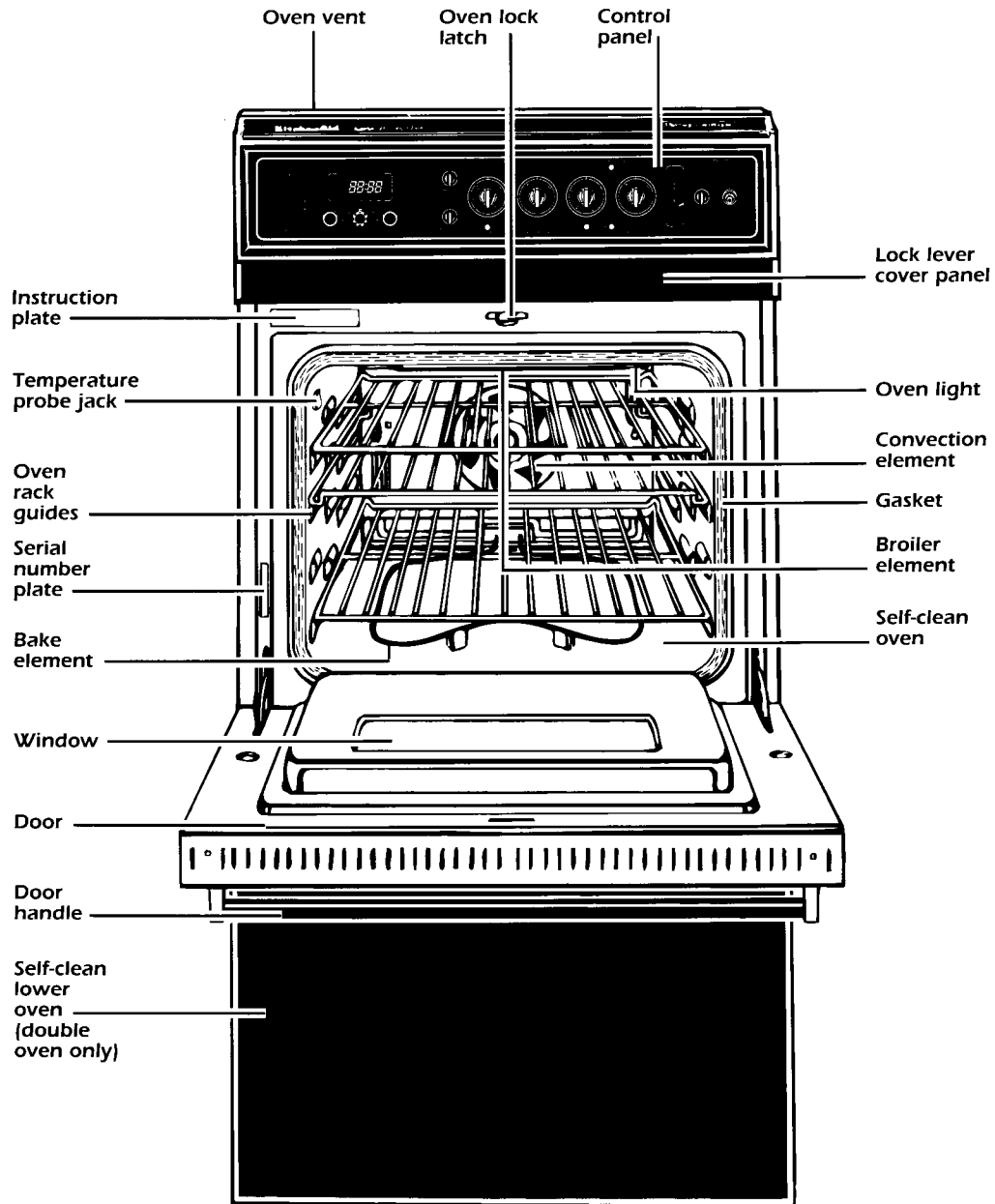

Double Oven Control Panel

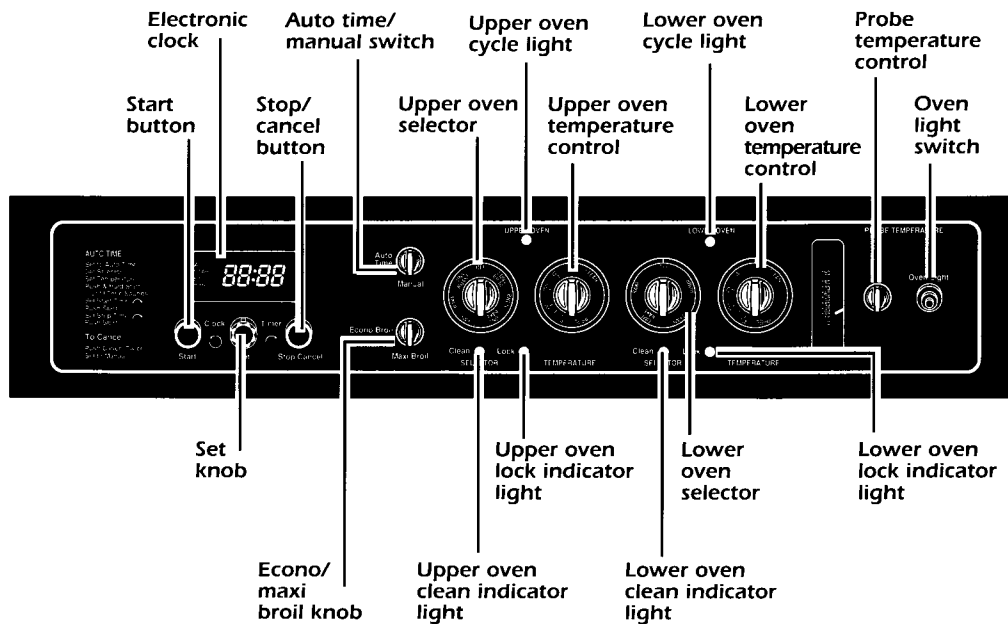

Single Oven Control Panel

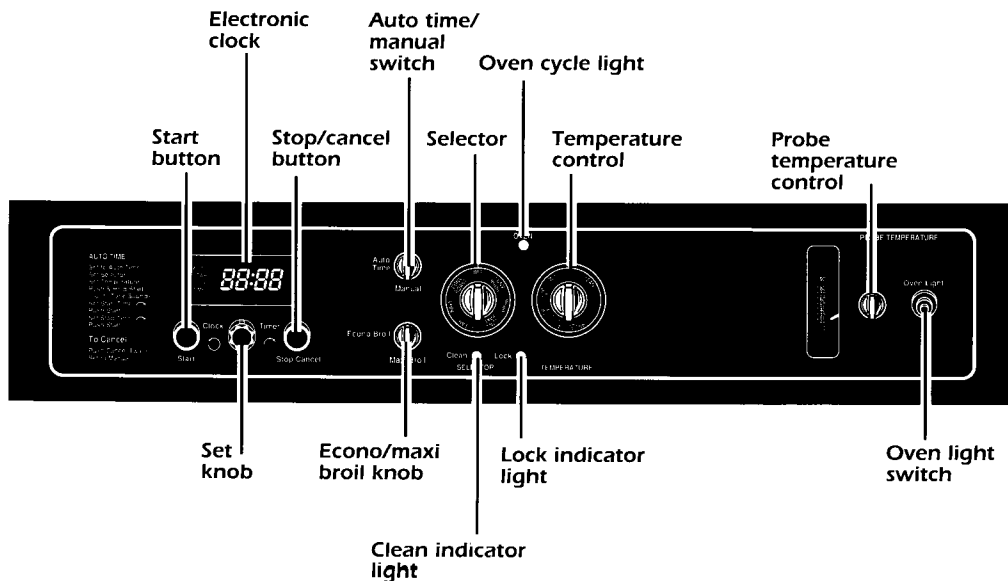

Utensil Setting Use Chart

Use either the broiler pan grid or the convection roasting rack with the broiler pan. See pages 15 and 17 for additional information.

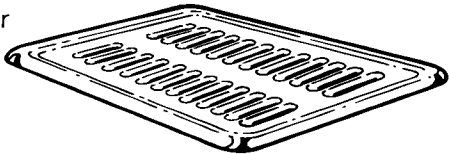
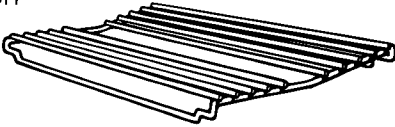
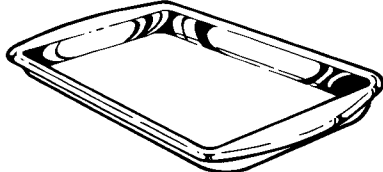
UTENSIL	SETTING
Broiler pan grid 	BROIL CONVECTION BROIL
Convection roasting rack 	CONVECTION ROAST
Broiler pan 	BROIL CONVECTION BROIL CONVECTION ROAST

About Convection Ovens

The word “convection” means “the act of conveying.” A convection oven is like a hair dryer – there is a heating element and a fan. The fan conveys the heat from the heating element around the oven cavity by moving the air. A standard oven is like a heat lamp – the heat radiates from the heating element to the food, but the air does not move. The moving air in a convection oven offers better baking results when cooking with multiple oven racks because the air can get to all sides of the food. It also tends to heat foods faster.

Because of faster heating, many types of foods can be cooked at lower temperatures than those suggested for standard ovens.

For example, you can roast a large cut of meat in a convection oven at 300°F (usually for a shorter period of time) compared to 325°F in a standard oven. Fruit and nut breads bake best at 300°F in a convection oven – about 50°F lower than the temperature recommended for a standard oven.

Convection ovens also tend to maintain a constant temperature (because of the hot swirling air) which leads to more even cooking. Egg and cheese dishes bake higher and lighter in a convection oven. A constant, even temperature also results in lofty soufflés and puffy, crisp-crustéd quiche.

Using the Oven

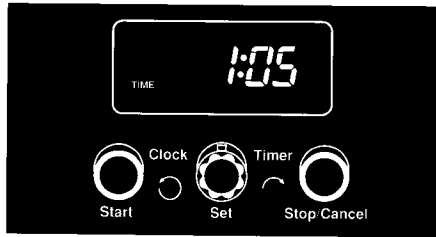

Electronic Clock Operation

The electronic clock controls all timed operations for both the single/upper oven and lower oven. It consists of the display, Start Button, Set Knob and Stop/Cancel Button. When your oven is first connected to the power in your home, "00:00" will appear in the display.

To set the time of day:

1. Turn the Set Knob one full turn counterclockwise until a tone is heard and "TIME" appears in the display.
2. Continue turning the Set Knob in either direction until the correct time of day appears in the display.
3. Press the Start Button to begin clock operation.

To use the minute timer:

The Minute Timer can be programmed from 5 seconds to 99 minutes for precise timing of short and long-term cooking, or any other activity. The Minute Timer is only an audible reminder and will not turn the oven ON or OFF.

1. To use, turn the Set Knob clockwise. The display will immediately change to "5" and "TIMER" will be displayed.
2. Continue turning until the desired time is displayed (in minutes and seconds) in the display.

Displayed time increases in the following increments:

From 5 seconds to 2 minutes	5 second increments
From 2 minutes to 10 minutes	10 second increments
From 10 minutes to 20 minutes	30 second increments
From 20 minutes to 99 minutes	1 minute increments

3. To start the Minute Timer, press the Start Button.

The display will continue to show "TIMER" and the selected time will begin counting down. At the end of the timed period, "TIMER" will flash rapidly in the display and a tone will sound for 3 seconds, after which an intermittent tone will sound until the Minute Timer is cancelled, or until a total of 15 minutes have elapsed.

IMPORTANT: The current time of day may be checked while the Minute Timer is in use by touching the Start Button. The time of day will be displayed for 7 seconds, then return to the Minute Timer program in progress.

Press the Stop/Cancel Button once to turn off the reminder tone at the end of the Minute Timer program.

To cancel a Minute Timer program in progress, press the Stop/Cancel Button once. A tone will sound and the clock will return to the time of day.

IMPORTANT: The Minute Timer may be used at the same time as an automatic time cooking or Self-Clean program. The time cooking or Self-Clean program must be set first, then the Minute Timer. The Minute Timer countdown will show in the display. One touch of the Stop/Cancel Button will cancel the Minute Timer and two touches will cancel the cooking or cleaning program.

Lower Oven Controls (For Double Ovens)

The lower oven is a thermal oven which can be used for broiling, baking and roasting. It has two controls – a Selector and a Temperature Control. Both controls must be set for the oven to work.

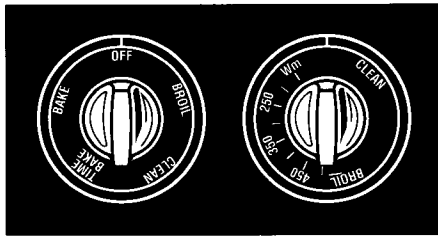

Temperature control:

The Temperature Control can be set at any temperature from Wm (warm/150°F) to BROIL (550°F), or on CLEAN. Settings Wm to 225°F are suggested for warming and holding foods.

When setting the Temperature Control, if you accidentally go past the desired setting, turn the dial fully counterclockwise and then reset to the desired setting to get an accurate temperature setting. Be sure the Temperature Control is turned fully counterclockwise when the oven is not in use.

Selector:

The Selector has five settings:

BROIL – The top elements operate at full power whenever heating. Use this setting for broiling.

CLEAN – Use this setting for self-cleaning only.

TIME BAKE – The bottom element and outer top element operate at full power and glow red whenever heating. Use this setting for automatic time cooking.

BAKE – The bottom element and outer top element operate at full power and glow red whenever heating. Use this setting for baking, roasting and for heating casseroles.

OFF – Use this setting to turn the oven off.

Single/Upper Oven Controls

The single/upper oven is a thermal-convection oven. The four heating elements (one on bottom, one at rear and two on top) and a circulation fan are used in various combinations to bake/roast, convection bake, convection roast, broil, convection broil and dehydrate. It has two controls – a Selector and a Temperature Control. Both controls must be set for the oven to work.

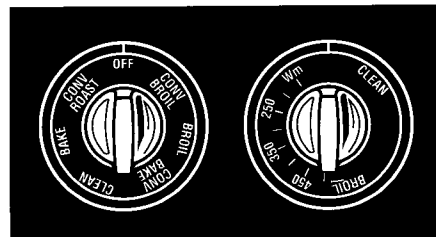

Temperature control:

The Temperature Control can be set at any temperature from Wm (warm/150°F) to BROIL (550°F), or on CLEAN. Settings Wm to 225°F are suggested for warming and holding foods.

When setting the Temperature Control, if you accidentally go past the desired setting, turn the dial fully counterclockwise and then reset to the desired setting to get an accurate temperature setting. Be sure the Temperature Control is turned fully counterclockwise when the oven is not in use.

Selector:

The Selector has seven settings. The chart on the following page shows diagrams of which heating elements are involved in each setting, and information on each setting.

Selector settings for single/upper oven

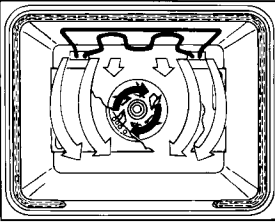
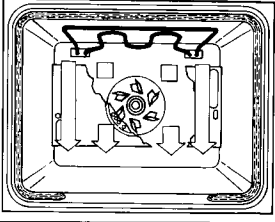
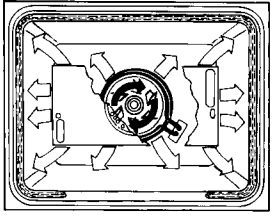
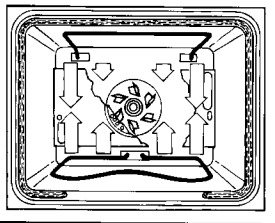
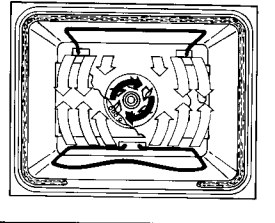
SETTING	DIAGRAM	SETTING INFORMATION
CONVECTION BROIL		<p>The top element(s), as set by the Econo/Maxi Broil Knob, operates at full power whenever heating. Air in the oven cavity is circulated by the fan for even heating. Use this setting for broiling thick cuts of meat.</p>
BROIL		<p>The top element(s), as set by the Econo/Maxi Broil Knob, operates at full power whenever heating. Use this setting for broiling.</p>
CONVECTION BAKE		<p>The rear element operates at full power whenever heating. Air in the oven cavity is circulated by the fan for even heating. Use this setting for foods which require gentle heating, and for baking breads and cakes. This setting is also recommended when baking large quantities of food on more than one oven rack.</p>
BAKE (ROAST)		<p>The bottom element and outer top element operate at full power and glow red whenever heating. Use this setting for baking, roasting, and heating casseroles.</p>
CONVECTION ROAST		<p>The bottom element and outer top element operate at full power and glow red whenever heating. Air in the oven cavity is circulated by the fan for even heating and faster cooking. Use this setting for roasting.</p>
CLEAN		<p>Use this setting for self-cleaning only.</p>
OFF		<p>Use this setting to turn the oven off.</p>

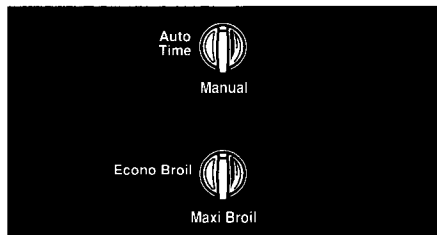

Maxi broil knob:

ECONO BROIL – Use to broil small amounts of food. For instance, two hamburgers, four hot dogs or four strips of bacon. Heat will come from the inner top element only.

MAXI BROIL – Use to broil large amounts of food. For instance, three or more hamburgers, five or more hot dogs, or five or more strips of bacon. Heat will come from both top elements.

Auto time/ manual switch:

AUTO TIME – Use with clock for automatic cooking.

MANUAL – Switch must be in the **MANUAL** position before oven will operate. Cooking starts immediately and stops when Selector is turned to **OFF**.

Rack Positions

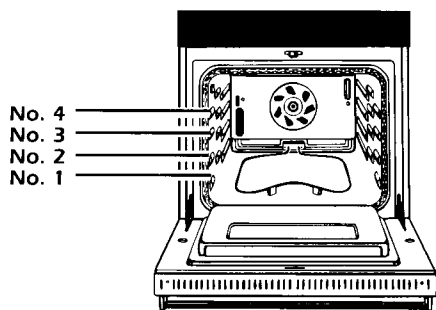

There are three racks for the single oven. Two racks are straight and the third is offset. The offset rack allows all three racks, when used together, to be an equal distance apart.

There are two racks provided in each oven for the double oven. One straight and one offset.

Your oven has four rack positions. Rack position 4 is the highest position, or farthest from the bottom of the oven. Rack position 1 is the lowest position, or closest to the bottom of the oven. Be sure to arrange the oven rack(s) before putting foods into the oven or turning the oven on.

When three racks are used in one oven, place one straight rack in position 4, the highest position or the farthest from the bottom; the other straight rack in position 1, the closest to the bottom of the oven; and the offset rack in position 2.

To remove oven racks:

1. Pull rack out until bar on back of rack touches first stop.
2. Lift front of rack until rear of rack slides out between the two front stops.

Rack and Pan Placement

The racks should be placed so the top of the food will be centered in the oven.

For proper cooking, follow these guidelines for specific foods:

- Angel and bundt cake, yeast breads, frozen pies, large roasts and turkeys – place rack on lowest level
- Casseroles, muffins, most quick breads and meats – place rack on second level from bottom
- Cookies, biscuits, cakes and non-frozen pies – place rack on second or third level from bottom

When baking on two racks, arrange racks on bottom and third level from bottom.

⚠ WARNING

Fire and Personal Injury Hazard

- Always position oven racks in desired location before turning oven on. Be sure the racks are level.
- If racks must be moved while oven is hot, use potholders or oven mitts to protect hands.
- Do not let potholders or oven mitts contact hot heating elements.
- Always use a dry potholder or oven mitt to change racks or handle utensils in the oven. Do not use a damp potholder or oven mitt. Steam burns could result. Failure to follow the above precautions may result in fire or personal injury.

The hot air must circulate around the pans in the oven for even heat to reach all parts of the oven.

For best air circulation:

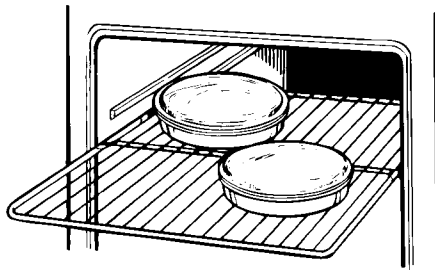

- Place the pans so that one is not directly over the other.
- Allow 1 1/2 to 2 inches of space around each pan and between pans and oven walls.

- When cooking with one pan, place pan in the center of the oven rack.
- When cooking with two pans, place pans in opposite corners of the oven rack.
- Use only one cookie sheet in the oven at one time.

IMPORTANT: "Oven peeking" may cause heat loss, longer cooking times and unsatisfactory baking or roasting results. Rely on your timer.

Using Aluminum Foil in the Oven

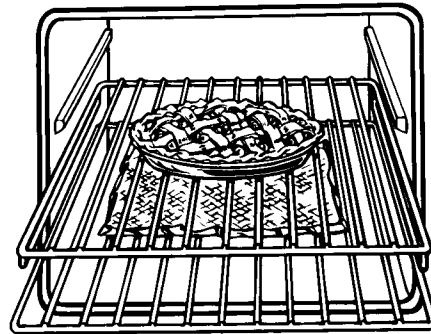

Use aluminum foil to catch spillovers from pies or casseroles.

- Place the foil on the oven rack below the rack with the food. The foil should have the edges turned up and be about 1 inch larger all around than the dish holding the food.
- Do not cover the entire rack with aluminum foil. It will reduce air circulation and cause poor cooking results.

⚠ WARNING

Electrical Shock, Fire and Product Damage Hazard

- **Do not allow foil to touch the heating elements because it will damage them and could result in electrical shock or fire hazard.**
- **Do not line Self-Clean oven bottom or entire oven rack with foil or other liners. Poor baking will result. Damage to the oven finish will occur if foil is left in oven during Self-Clean cycle.**

Baking (Single/Upper or Lower Oven)

or

Convection Baking (Single/Upper Oven)

1. Arrange the oven rack(s) in the desired position(s).
2. Turn the Selector to BAKE or CONV BAKE.
3. Set the Temperature Control to the desired temperature. (See the baking or convection baking chart in the cookbook for temperature recommendations.)
IMPORTANT: For best results, preheat the oven when baking or convection baking, unless the recipe states otherwise. The Oven Cycle Light will go out when the set temperature has been reached. The light will cycle on and off with the elements during the heating process.
4. Place the food in the oven after the Oven Cycle Light goes out, or when the recipe specifies.

Be sure to turn the Selector to OFF and the Temperature Control fully counterclockwise when cooking is completed.

Convection baking tips:

- Reduce recommended recipe oven temperature by approximately 25°F. See recipe adaption chart in the cookbook for recommended temperatures.
- For most recipes, convection baking time can be reduced compared to standard baking times. See recipe adaption chart or convection baking chart in the cookbook for recommended baking times.
- When baking with 2 or 3 racks, use the CONV BAKE setting for more even results.
- Stagger cake pans in opposite directions on each rack when three racks are used.

Dehydrating (Single/Upper Oven)

Your KitchenAid Thermal-Convection™ Oven can be used to dehydrate fruits and vegetables.

1. Prepare foods as recommended in recipe.
2. Arrange food on drying racks.*
3. Turn Selector to CONV BAKE.
4. Set the Temperature Control to Wm (warm). It may be necessary to turn the Temperature Control to the right of the Wm setting to achieve the recommended temperature. Place an oven thermometer in the oven to be certain that the correct temperature is obtained.

To learn more about dehydration, see the cookbook provided with your oven.

* Racks are not included with oven. Contact a local store handling specialty cooking utensils.

Roasting (Single/Upper or Lower Oven)

or

Convection Roasting (Single/Upper Oven)

1. Arrange the oven rack(s) in the desired position(s) and place the food in the oven.
2. Turn the Selector to BAKE (for Roasting) or CONV ROAST (for Convection Roasting).
3. Set the Temperature Control to desired temperature. (See the roasting or convection roasting chart in the cookbook for recommended temperatures.)

Be sure the Selector is turned to OFF and the Temperature Control is turned fully counterclockwise when cooking is completed.

Roasting tips:

- Roast meats fat side up in a shallow pan using a roasting rack.
- Use a roasting pan that fits the size of the food to be roasting. Meat juices may overflow the sides of a pan that is too small. Too large of a pan will result in increased oven spatter.
- Spatter can be reduced by lining the bottom of the roasting pan with lightly crushed aluminum foil.
- A foil tent will slow down surface browning for long-term roasting, as when roasting a turkey. Place tent-shaped foil loosely over meat to allow for air circulation. Do not seal foil or meat will be steamed.

Not recommended for convection roasting.

- Use an accurate meat thermometer or temperature probe (see page 16) to determine when meat has reached desired

degree of doneness. Insert the thermometer or probe into the center of the thickest portion of the meat or into the inner thigh or breast of poultry. For an accurate reading, the tip of the thermometer or probe should not touch fat, bone or gristle. See roasting chart in the cookbook for recommended internal temperatures.

- After reading the thermometer once, push it further into the meat 1/2 inch more and read it again. If the temperature drops, return the meat to the oven for more cooking.
- Remove roasted meats from the oven when the thermometer registers 5°F to 10°F lower than the desired temperature. The meat will continue to cook after removal from the oven.
- Poultry and roasts will be easier to carve if loosely covered with foil and allowed to stand 10 to 15 minutes after removal from the oven.

Convection roasting tips:

- For most recipes, convection roasting times and temperatures can be reduced. See recipe adaption chart or convection roasting chart in the cookbook for recommended roasting times and temperatures.
- For convection roasting, do not use a roasting pan with high sides, as it cuts down the free flow of air circulating around the food. Use the convection roasting rack on the broiler pan as shown on page 8. (The convection roasting rack rests on the broiler pan, not inside it.) The long side of the rack should be parallel with the oven door for best heat distribution and airflow.

Temperature Probe (Single/Upper Oven)

The Temperature Probe is the most accurate guide to the degree of doneness of meat. Use it when roasting any type of meat or poultry.

1. Insert the Temperature Probe into the center of the thickest portion of meat or into the inner thigh or breast of poultry, away from fat or bone.
2. Place pan with meat on rack that has been centered in the oven.
3. Open the Temperature Probe cover located on the left side of the oven wall. Insert plug into jack. (Keep the top of the probe as far as possible from the heat source.)
4. Close the oven door.

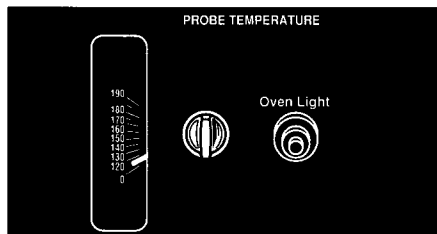

5. Set the Selector to BAKE or CONV ROAST.
IMPORTANT: The Probe Temperature Guide will light up.
6. Set Probe Temperature Control to the desired setting. (See the roasting or convection roasting chart in the cookbook for recommended internal meat temperatures.)
7. Set the Temperature Control to the desired roasting temperature.

What happens during this selection:

The oven will begin heating. The heating elements will cycle on and off to maintain the proper temperature. The rear convection fan will come on in addition to the heating elements when CONV ROAST is selected. The red hand of the Probe Temperature Guide will move up the scale to indicate the current internal meat temperature. After the red hand reaches the white hand, a continuous tone will sound indicating that the selected internal temperature has been reached. The oven will continue to heat and the tone will continue to sound until the oven is turned off.

To turn off oven and warning signal:

1. Turn the Selector to OFF and the Temperature Control fully counterclockwise.
2. Unplug the Temperature Probe using an oven mitt or potholder.

⚠ WARNING

Burn Hazard

Oven, probe and probe cover will be hot. Use an oven mitt or a potholder to remove the probe. Failure to do so could result in burns.

3. Remove food from oven to prevent overcooking.
4. Wipe probe with a soapy cloth and dry thoroughly. Use a plastic scouring pad to remove cooked-on foods.

IMPORTANT: DO NOT immerse Temperature Probe in water or other liquid.

Broiling (Single/Upper or Lower Oven)

1. Arrange the oven rack(s) in the desired position(s), see the broiling chart in the cookbook for recommended rack placement.
2. Place food on grid in broiler pan and place in center of the oven rack. Turn the pan so the long side is parallel to the oven door for the best heat distribution and air flow.
3. Turn the Selector to BROIL. Do not preheat the broiler.
4. Set the Temperature Control to the desired temperature. (See the broiling chart in the cookbook for recommended temperatures.)
5. Turn the Econo/Maxi Broil Knob to desired setting.
6. Position the oven door at the Broil Stop position.

Be sure to turn the Selector to OFF and the Temperature Control fully counterclockwise when broiling is completed.

Convection Broiling (Single/Upper Oven)

Convection broiling is actually high-temperature convection roasting. It is used when broiling thick cuts of meat. Results are similar to those obtained when using a rotisserie.

1. Arrange the offset oven rack in the #2 rack position.
2. Place meat on grid in broiler pan and place in center of the oven rack. Turn the pan so the long side is parallel to the oven door for best heat distribution and air flow.
3. Turn the Selector to CONV BROIL. Do not preheat the broiler.
4. Set the Temperature Control to the desired temperature. (See the convection broiling chart in the cookbook for recommended temperatures.)

5. Turn the Econo/Maxi Broil Knob to the desired setting.
6. Close the oven door completely.
7. Turn meat over approximately halfway through broiling time.

Be sure to turn the Selector to OFF and the Temperature Control fully counterclockwise when broiling is completed.

Broiling tips:

- Always start broiling with a cold broiler pan for even results.
- To retain more natural juice, do not pierce meat with a fork.
- Trim the outer layer of fat from steaks and chops.
- Slit fatty edges to prevent meat from curling during broiling.
- Brush food with butter, sauce or seasoning, if desired, several times during broiling.
- Grease the broiler pan grid when broiling fish to prevent sticking.

⚠ WARNING

Fire Hazard

- **Place meat the correct distance from the element. Meat placed too close to the element may spatter, smoke, burn or catch fire during broiling.**
- **To ensure adequate grease drainage, do not use cookie sheets or similar pans for broiling. Also, covering the broiler grid with foil is not recommended. Poor drainage of grease may result in fire. If foil is used, cut slits in foil to correspond with all openings in broiler grid. Grease can then drain away and cool in pan.**

Automatic Time Cooking

Automatic time cooking allows you to turn the oven on and off automatically. The starting time can be set to come on now or later.

On double oven models, both the upper and lower oven can be set for automatic time cooking at the same time. They will have the same start and stop times. However, the Temperature Controls may be set at different temperatures.

Single/upper oven:

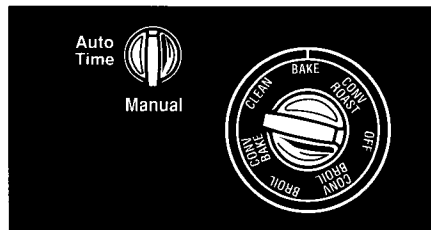

The oven may be automatically timed to bake, roast, convection bake and convection roast. The Selector for the upper oven will be set at one of these settings and the Auto Time Switch set to AUTO TIME.

IMPORTANT: Automatic time cooking should not be used when the Selector is set on BROIL or CONV BROIL.

Lower oven:



The oven may be automatically timed to bake or roast. The Selector will be set at TIME BAKE and the Temperature Control may be set at a different temperature from the upper oven.

Instructions:

1. Arrange oven rack(s) in desired position(s) and place food in the oven.

2. **Single/upper oven** – Set the Selector to the desired cooking setting. Set the Temperature Control to the desired temperature and turn the Auto Time Switch to AUTO TIME.

Lower oven – Turn the Selector to TIME BAKE and set the Temperature Control to the desired temperature.

3. Check to see that the electronic clock is set to the correct time of day. If not, reset following the instructions on page 9.



4. Set the start time. Touch the Start Button and hold down for 2 seconds. "START TIME" will appear in the display and a short tone will sound.
5. To start cooking now, touch the Start Button again to set in the start time and go to the next step.

To start cooking later, turn the Set Knob until the desired start time appears in the display, then touch the Start Button again to set the start time.



6. Set the stop time. After the start time is set, "STOP TIME" will appear in the display. Turn the Set Knob until the desired stop time appears in the display. Touch the Start Button again to set the stop time and begin the program.



7. "AUTO" will appear continuously in the display if the automatic time bake cycle has been programmed to start now. "AUTO" will flash in the display if the automatic time cooking cycle has been programmed to start later. "AUTO" will change from flashing to continuous when the programmed start time is reached.

⚠ WARNING

To avoid sickness and food waste when using automatic time cooking:

- **Do not use foods that will spoil while waiting for cooking to start, such as dishes with milk or eggs, cream soups, and cooked meats or fish. Any food that has to wait for cooking to start should be very cold or frozen before it is put in the oven. MOST UNFROZEN FOODS SHOULD NEVER STAND MORE THAN TWO HOURS BEFORE COOKING STARTS.**
- **Do not use foods containing baking powder or yeast when using delay start. They will not rise properly.**
- **Do not allow food to remain in oven for more than two hours after end of cooking cycle.**

What happens during this selection:

- The oven will come on at the time selected and maintain the temperature set on the Temperature Control until the selected stop time.
- At the end of the cooking period, the oven will shut off. "AUTO" will flash rapidly in the display. A tone will sound for 3 seconds, followed by an intermittent tone until the Stop/Cancel Button is touched or a total of 15 minutes has elapsed.
Foods should be removed from the oven when the cooking time has ended, or they will tend to overcook.

To review a program:

Press, and hold for 2 seconds, the Start Button for the start time or the Stop/Cancel Button for the stop time. The start or stop time will appear in the display for 7 seconds.

To change a program:

Press, and hold for 3 seconds, the Start Button for the start time or the Stop/Cancel Button for the stop time. Turn the Set Knob to the new desired time, then touch the Start Button to set the new time.

To cancel an automatic time cooking program in progress:

Touch the Stop/Cancel Button twice. A tone will sound each time button is pushed and the clock will return to the present time of day. The oven will automatically turn itself off.

IMPORTANT: If you wish to continue cooking in the single/upper oven, the Auto Time Switch must be turned to MANUAL. The lower oven Selector must be manually reset to BAKE or BROIL to continue cooking.

Care and Cleaning

Several finishes have been used on this oven. To prevent damage to these finishes, follow the suggested cleaning method(s) for that finish.

IMPORTANT: Some finishes can be damaged from harsh and abrasive cleaning agents.

⚠ WARNING

**Burn and
Electrical Shock Hazard**
Make sure all controls are
OFF and the oven is **COOL**
before cleaning. Failure to
do so could result in burns
or electrical shock.

Control Knobs

Turn control knobs to the OFF position. Pull the control knobs straight off. Clean with warm, soapy water and rinse well. Do not soak. Dry completely and replace by pushing them firmly into place.

IMPORTANT: After cleaning, make sure all the control knobs either point to the OFF position, or are turned fully counterclockwise.

Glass Surfaces

Clean with warm, soapy water. Rinse and dry well. Use mild glass cleaner to remove fingermarks.

IMPORTANT: When cleaning, never use steel wool, abrasives, or commercial oven cleaners which may damage the finish.

Porcelain Surfaces

Clean with warm, soapy water. Rinse and dry with soft cloth.

Chrome Surfaces and Trim

Clean with warm, soapy water. Rinse and dry well. Use mild glass cleaner to remove fingermarks. For heavily-soiled areas, clean with an ammonia solution of 1 cup ammonia to 2 gallons of water.

Broiler Pan

Clean with warm, soapy water. For heavily-soiled areas, use a soap-filled steel wool pad with plenty of water. Rinse well. Do not clean in the Self-Clean cycle.

Oven Racks

Clean with warm, soapy water. For heavily-soiled areas, soak in ammonia solution of 1 cup ammonia to 2 gallons of water.

Temperature Probe

Clean with detergent and wet cloth. Do not immerse probe in water.

Self-Clean Oven Cycle (Single/Upper or Lower Oven)

The Self-Clean cycle is designed to eliminate the need for scrubbing soil baked onto the oven interior. The Self-Clean cycle heats to a high temperature to burn off soil.

The length of cleaning time can be set to meet your cleaning needs. A 2½ hour Self-Clean cycle is usually ample to clean a moderately soiled oven. A 4 hour Self-Clean cycle is suggested for an oven with heavy soil build-up. The Self-Clean cycle can also be delayed to a more convenient time if desired.

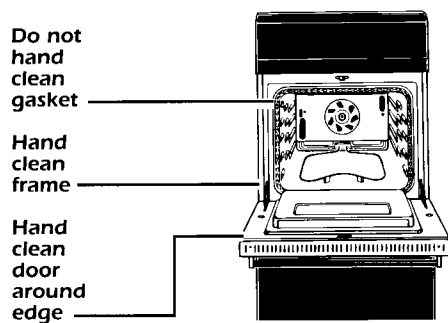

Before starting a self-clean cycle:

1. To extend oven light bulb life, turn oven light off before using the Self-Clean cycle.
2. Remove all items and the oven racks from the oven. It is recommended that the oven racks be removed as they will discolor and darken during the Self-Clean cycle. If the oven racks remain in the oven during the Self-Clean cycle, wipe the sides with vegetable oil after cleaning so they will slide easier. Broiler pan, broiler grid or cooking utensils should not be cleaned in the oven. Heavy grease build-up on these items will produce smoke which can be discharged into the kitchen.
3. Wipe up large spillovers in the oven cavity with a damp cloth. The bottom element is hinged for easier cleaning of the cavity floor. Never use chemical oven cleaners inside a self-cleaning oven or on raised portion of the door.

IMPORTANT: The bottom element must be in the down position before beginning the Self-Clean cycle.

The smoke eliminator will handle the normal flow of odors during the Self-Clean cycle. However, minor smoke may be noticed when soil build-up is heavy. Also, some smoke may occur during the very first cleaning cycle due to burn-off of binders in oven insulation. To help remove additional smoke, heat and odors turn on a vent hood or other kitchen vent during the Self-Clean cycle.

4. Wipe soil from oven frame area outside of gasket, and inside the oven door. Wash with warm, soapy water. (The center area of the door does not need to be hand cleaned.) Rinse well with mixture of vinegar and water and wipe dry. A non-scratch scouring pad may be used on heavily-soiled areas. Wash surfaces frequently to minimize overall cleaning as these areas are not cleaned during the Self-Clean cycle.

IMPORTANT: Do not clean, move or bend gasket. Poor cleaning and baking may result.

The lower oven will not operate while the upper oven is being cleaned, and the upper oven will not operate while the lower oven is being cleaned. If an attempt is made to clean both ovens at the same time, neither will operate.

⚠ WARNING

Personal Injury and Product Damage Hazard

- Do not touch the oven during the Self-Clean cycle. It could burn you.
- Do not use commercial oven cleaners in your oven. Cleaners may produce hazardous fumes or damage the porcelain finish.
- Do not force the Lock Lever, you could break it. The lever is designed to stay locked until the oven is cool enough to open safely. Wait until it moves freely.
- Do not use foil or other liners in the oven. During the Self-Clean cycle, foil can burn or melt and damage the oven surface.
- Do not block the vent during the Self-Clean cycle. Air must move freely for best cleaning results.

Starting the automatic self-clean cycle:

1. Follow steps under "Before starting a self-clean cycle" on page 21.
2. Make sure that the electronic clock is set to the correct time of day. If not, reset following the instructions on page 9.

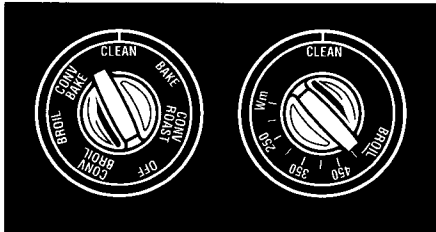

3. Set the Selector to CLEAN. Turn the Temperature Control fully clockwise to CLEAN.
4. Lift the Lock Lever Cover Panel between the oven door and the control panel. Slide the Oven Lock Lever all the way to the right. You will hear a tone and "START TIME" will appear in the display. The lower oven Lock Lever is located between the oven doors.

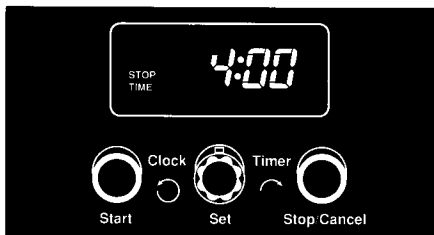

5. Touch the Start Button to set the present time of day as the start time. "STOP TIME" and the actual cleaning time, 2 1/2 hours from the present time of day, will appear in the display.



6. Touch the Start Button to set the automatically selected stop time and return the clock to the present time of day. "AUTO" will appear in the display. The Clean Indicator Light will glow, and the cleaning cycle will begin. No end-of-cycle tone will be given.
7. At the end of the Self-Clean cycle, the Clean Indicator Light and "AUTO" will go out.

Delaying the automatic self-clean cycle:

The start of the Self-Clean cycle can be postponed to a more convenient time, if desired. The controls may be set to delay the Self-Clean cycle for up to 12 hours.

1. Follow steps 1, 2, 3 and 4 under "Starting the automatic self-clean cycle."
2. Turn the Set Knob until the desired new start time appears in the display.
3. Touch the Start Button to set the new start time. "STOP TIME" and the actual cleaning stop time, 2 1/2 hours from the present time of day, will appear in the display.
4. Touch the Start Button to set the stop time and return the clock to the present time of day. "AUTO" will flash in the display until the Self-Clean cycle begins. Once the cycle is in progress, "AUTO" will appear continuously. No end-of-cycle tone will be given.

Extending the automatic self-clean cycle:

If your oven is excessively dirty and requires longer cleaning time, the Automatic Self-Clean cycle can be extended for up to 4 hours.

1. Follow steps 1,2,3 and 4 under "Starting the automatic self-clean cycle."
2. When "STOP TIME" appears in the display, turn the Set Knob clockwise until the desired length of cleaning time is displayed. Remember, you will be adding time to the normal 2¹/₂ hour cleaning time.
IMPORTANT: A self-cleaning time longer than 4 hours cannot be selected.
3. Touch the Start Button to set the new stop time and return the clock to the present time of day.
4. "AUTO" will appear in the display and the Self-Clean cycle will begin. No end-of-cycle tone will be given.

Combining the delayed and extended self-clean cycle options:

An Automatic Self-Clean cycle can be both delayed and extended, if desired.

1. Follow steps 1,2,3 and 4 under "Starting the automatic self-clean cycle."
2. Set the delayed start time by turning the Set Knob until the new start time appears in the display. Touch the Start Button to set the new start time.
3. Follow steps 2 and 3 under "Extending the automatic self-clean cycle" above.
4. "AUTO" will flash in the display until the Self-Clean cycle begins. Once the cycle is in progress, "AUTO" will appear continuously. No end-of-cycle tone will be given.

To stop the self-clean cycle at any time:

1. Touch the Stop/Cancel Button twice. A tone will sound each time and the clock will return to the present time of day.
2. Slide the Oven Lock Lever all the way to the left.

IMPORTANT: If the Lock Indicator Light has come on, wait until the oven cools and the light goes off before sliding the Lock Lever back to the left. **Do not force it. Wait until it moves easily.**

3. Turn the Selector to OFF and the Temperature Control fully counterclockwise.

To return oven to regular use after a self-clean cycle:

1. Slide the Oven Lock Lever all the way to the left.
2. Turn the Selector to OFF and the Temperature Control fully counterclockwise.
3. Allow oven to cool sufficiently before wiping up any residue.

What happens during the self-clean cycle:

The oven not being cleaned will not heat even though the controls are set.

After the controls have been set for a non-delayed cycle, or after the delayed time has elapsed on a delayed cycle:

- The Oven Cycle Light will glow to tell you the oven is ON.
- The Clean Indicator Light will glow to tell you the oven is slowly heating to the clean temperature, and "AUTO" will appear continuously in the display.
- The Lock Indicator Light will come on when the temperature reaches 575°F-600°F (approximately 15 minutes).

Continued on next page

At the end of the Self-Clean cycle:

- The Clean Indicator Light will go out.
- The Lock Indicator Light will continue to glow until the oven temperature drops below 550°F. The oven door cannot be opened until the Lock Indicator Light goes out. Do not turn Temperature Control or Selector to OFF until Lock Indicator Light goes out.

Oven self-cleaning tips:

- Evening is a good time to clean the oven, after normal oven use is completed.
- Small amounts of smoke escaping from the oven vent are normal when oven is heavily soiled. Excessive smoke may indicate heavy spillovers have not been wiped up.
- **Do not** force the Oven Lock Lever open when the Lock Indicator Light is on. Damage to the lock mechanism may result.
- To prevent accidental locking, the Oven Lock Lever should always be unlocked (positioned to the far left) except when the Selector and Temperature Control are set at CLEAN. If accidental locking occurs, turn oven off. Allow oven temperature to decrease so Lock Lever can be moved. Do not force Lock Lever. Wait until it moves easily.
- Clean both ovens regularly, before they become "excessively dirty." If oven is not clean after one cycle, repeat the Self-Clean cycle.
- After a Self-Clean cycle, any powdery residue can be wiped away with a damp cloth. If white spots remain in the oven after a Self-Clean cycle, remove them with a non-scratch scouring pad before using the oven again. These spots are usually salt residues that cannot be removed during the Self-Clean cycle.
- If the soil removal was not complete, increase the length of the clean time in the next cycle.

Adjusting the Temperature Control

Does your oven seem hotter or colder than your old oven? The temperature of your old oven may have shifted gradually without you noticing the change. Your new oven is properly adjusted to provide accurate temperatures. But when compared to your old oven, the new design may give you different results.

If, after using the oven for a period of time, you are not satisfied with the temperature settings, they can be adjusted by following these steps:

1. Pull the Temperature Control knob straight off.
2. Loosen the screws $1/2$ turn with a Phillips screwdriver.

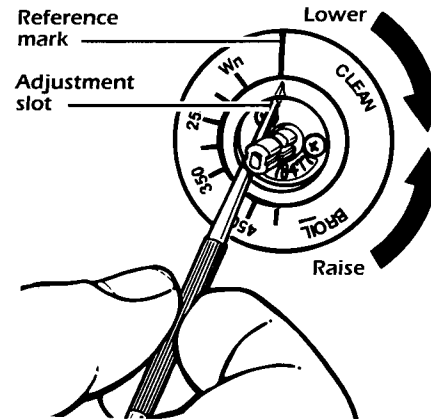

3. Put the blade of a small flat screwdriver into the slot of the temperature dial.
4. Use the screwdriver to rotate the temperature dial. The initial dial position is at "0" relative to the center hub reference mark. Each mark equals a 20°F change in temperature. Rotate the dial counterclockwise to raise the temperature, or clockwise to lower the temperature.
5. Tighten the screws and replace the knob.

Oven Lights – Operation/Replacement

In double oven, the oven lights in both ovens come on when either oven door is opened. To turn the light(s) on when the oven door(s) is closed, push the Oven Light Switch on the control panel. Push the switch again to turn off the light(s).

⚠ WARNING

Electrical Shock and Personal Injury Hazard

- **Make sure oven and light bulb are cool and power to the oven has been turned OFF before replacing the light bulb. Failure to do so could result in electrical shock or burns.**
- **The lens must be in place when using the oven. The lens protects the bulb from breaking, and from high oven temperatures. Broken glass could cause injury.**

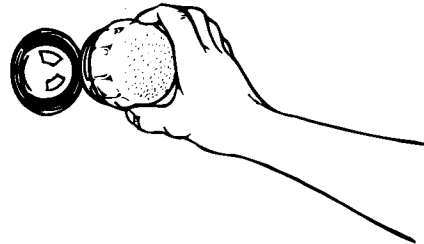

To replace an oven light bulb:

1. Turn off power at the main power supply.
2. Unscrew lens from housing.
3. Unscrew light bulb and replace with a 40-watt appliance bulb.
4. Replace the lens.
5. Turn power back on at the main power supply.

IMPORTANT: Make sure oven light is off during the Self-Cleaning cycle. Keeping oven light on will shorten bulb life.

Optional Oven Door Fronts

The front door glass can be changed to match your kitchen decor. The following front kits are available from your KitchenAid dealer: White Glass (Kit No. 3179501), and Almond Glass (Kit No. 3179503). Two kits are required for a double oven. These kits include easy installation instructions.

Removing and Replacing an Oven Door

Both oven doors can be removed to change optional oven door fronts. **Do not** remove them for cleaning.

⚠ WARNING

Personal Injury Hazard

- Oven doors are heavy. Use both hands to remove the oven doors.
- Grasp only the sides of the oven door. Do not use any portion of the front frame or trim for lifting.

Failure to grasp the oven door properly could result in personal injury or product damage.

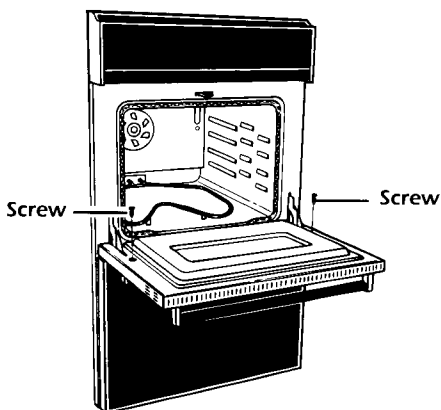

To remove:

1. Open the door completely.
2. Remove the two screws just above the oven door hinges.
3. Close door to the Broil Stop position (door will be open about 6 inches).
4. Hold the door firmly on both sides. Pull forward slightly, lift the door up and out of the hinge slots to remove. Set the door aside.



To replace:

1. Grasp door firmly on both sides. Slide the hinge slot in the bottom of the door over the hinges. Push the door down and in to replace.
2. Open the door slightly past the Broil Stop position and push it down to make sure the door is completely installed.
3. Open the door completely. Replace the two oven door screws.
4. Close and open the door slowly to make sure it is replaced properly.

For Service or Assistance

Follow These Steps

1. If your oven should fail to operate, review the following list before calling your dealer. You could save the cost of a service call.

If the oven will not operate:

- Have instructions in this book been followed?
- Is the power supply cord connected to a live circuit with the proper voltage? (See Installation Instructions.)
- Has the fuse blown, or is the circuit breaker open?
- Is the Selector turned to BAKE or BROIL? If Selector is turned to TIME BAKE, wait until the start time is reached.
- Is the Temperature Control turned to a temperature setting?
- Is automatic time cooking set correctly?
- Is Auto Time/Manual Switch in correct position?
- Is Oven Lock Lever in proper position for cooking (left)? If Oven Lock Lever is locked accidentally, see "Oven self-cleaning tips" on page 24.

If the Self-Clean cycle will not operate:

- Are the Selector and Temperature Control set to CLEAN?
- Does the clock show the correct time of day?
- Have you set a delayed start time?
- Is the Oven Lock Lever all the way to the right?
- Are you trying to clean both ovens at the same time (see page 21)? Only one oven can be cleaned at one time.

If cooking results are not what you expected:

- Is the oven level?
- Does the oven temperature seem too low or too high? See page 24.
- If needed, have you preheated the oven as the recipe calls for?
- Are you following a tested recipe from a reliable source?
- If baking, have you allowed 1 1/2 to 2 inches on all sides of the pans for air circulation?
- Are the pans the size called for in the recipe?

2. If the problem is not due to one of the above items:*

- Call KitchenAid Consumer Relations TOLL-FREE:

1-800-422-1230

and talk with one of our trained consultants. The consultant can instruct you in how to obtain satisfactory operation from your appliance or, if service is necessary, recommend a qualified service company in your area.

- If you prefer, write to:

Consumer Relations Department
KitchenAid
P.O. Box 558
St. Joseph, MI 49085-0558

Please include a daytime phone number in your correspondence.

3. If you need service:*

- Call your dealer or the repair service he recommends.
- All service should be handled locally by the dealer from whom you purchased the unit or an authorized KitchenAid servicer.
- If you are unable to obtain the name of a local authorized KitchenAid servicer, call our service assistance telephone number (see step 2).

4. If you are not satisfied with the action taken:*

- Contact the Major Appliance Consumer Action Panel (MACAP). MACAP is a group of consumer experts that voices consumer views at the highest levels of the major appliance industry.
- Contact MACAP only when the dealer, authorized servicer, or KitchenAid have failed to resolve your problem.
Major Appliance Consumer Action Panel
20 North Wacker Drive
Chicago, IL 60606
- MACAP will in turn inform us of your action.

* When requesting assistance, please provide: model number, serial number, date of purchase and a complete description of the problem. This information is needed to better respond to your request.

KitchenAid®

Electric Built-In Oven Warranty

LENGTH OF WARRANTY:	KITCHENAID WILL PAY FOR:	KITCHENAID WILL NOT PAY FOR:
ONE YEAR FULL WARRANTY FROM DATE OF INSTALLATION.	Replacement parts and repair labor costs to correct defects in materials or workmanship. Service must be provided by an authorized KitchenAid servicing outlet.	A. Service calls to: 1. Correct the installation of the oven. 2. Instruct you how to use the oven. 3. Replace house fuses or correct house wiring.
SECOND THROUGH FIFTH YEAR LIMITED WARRANTY FROM DATE OF INSTALLATION.	Replacement parts for any electric element to correct defects in materials or workmanship.	B. Repairs when oven is used in other than normal home use. C. Damage resulting from accident, alteration, misuse, abuse, improper installation or installation not in accordance with local electrical codes.
SECOND THROUGH TENTH YEAR LIMITED WARRANTY FROM DATE OF INSTALLATION.	Replacement parts for the porcelain oven cavity/inner door if either rusts through due to defects in materials or workmanship.	D. Any labor costs during the limited warranty. E. Replacement parts or repair labor costs for units operated outside the United States. F. Pick up and delivery. This product is designed to be repaired in the home.

KITCHENAID DOES NOT ASSUME ANY RESPONSIBILITY FOR INCIDENTAL OR CONSEQUENTIAL DAMAGES. Some states do not allow the exclusion or limitation of incidental or consequential damages, so this exclusion or limitation may not apply to you.

This warranty gives you specific legal rights and you may also have other rights which vary from state to state.

If you need service, first see the "Service and Assistance" section of this book. After checking "Service and Assistance," additional help can be found by calling our service assistance telephone number, **1-800-422-1230**, from anywhere in the U.S.

KitchenAid
St. Joseph, Michigan, U.S.A. 49085

® Registered Trademark / TM Trademark of KitchenAid

Part No. 3181352
©1990 KitchenAid

Printed in U.S.A.

Free Manuals Download Website

<http://myh66.com>

<http://usermanuals.us>

<http://www.somanuals.com>

<http://www.4manuals.cc>

<http://www.manual-lib.com>

<http://www.404manual.com>

<http://www.luxmanual.com>

<http://aubethermostatmanual.com>

Golf course search by state

<http://golfingnear.com>

Email search by domain

<http://emailbydomain.com>

Auto manuals search

<http://auto.somanuals.com>

TV manuals search

<http://tv.somanuals.com>