

KHMS 9010/I



FOR THE WAY IT'S MADE.®

Product description and symbols	4
Gas burner functions	4
Practical advice on how to use the burners	5
Injectors table	5
Induction zone functions	6
Positioning the pan supports and Wok support	7
Sizes and installation measurements (mm)	8
Precautions and general recommendations	9
Safeguarding the environment	10
Installation	11
Gas connection	12
Electrical connection	12
Securing the hob into cabinetry	13
Adaption to different kinds of gas	13
Replacing the injectors	14
Regulating the minimum level of the taps	14
General cleaning	15
Troubleshooting guide	16
After Sales Service	17

Product description and symbols

1. Removable pan supports
2. Professional double crown Wok burners
3. 145 mm diameter induction zone
4. Left gas burner control knob
5. Central gas burner control knob
6. Right gas burner control knob
7. Display and touch control panel for the induction zones

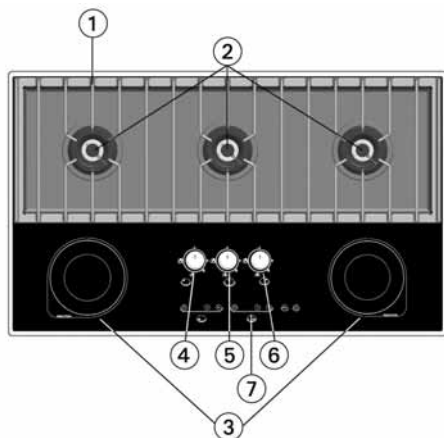

Gas burner control knob symbols

- A. Burner position indicator
 B. Flame regulation symbols

- Off
- Maximum external and internal crown flame
- Minimum external crown flame.
Maximum internal crown flame.
- External crown flame off.
Maximum internal crown flame.
- External crown flame off.
Minimum internal crown flame.

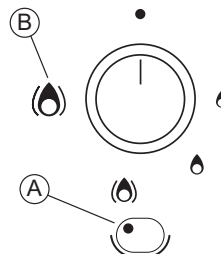

Gas burner functions

This hob is fitted with three professional gas double crown wok burners, which means that the gas burners are extremely flexible. Flexible enough to allow cooking at extremely high temperatures whilst also allowing cooking over a very low heat thanks to the central crown.

Even when the induction part is not on, the gas burners will work anyway.

Turning the gas burners on

- Push in the corresponding control knob to turn on one of the burners and rotate it anti-clockwise until the indicator on the control knob is lined up with the maximum flame symbol (flame in a circle).

- Press the control knob against the control panel to turn on the relevant burner. Once the burner is lit, keep the control knob pushed in for about 5 seconds to allow the safety thermocouple fitted to each gas burner to heat up. Then release the control knob. The thermocouple is a safety device that will shut off the gas supply should the flame accidentally go out (a gust of air, momentary lack of gas supply, liquid spillage, etc).
- **The control knob should not be pushed in for more than about 15 seconds. If the gas burner has not ignited within this time, return the control knob to the off position, wait at least a minute before trying again.**

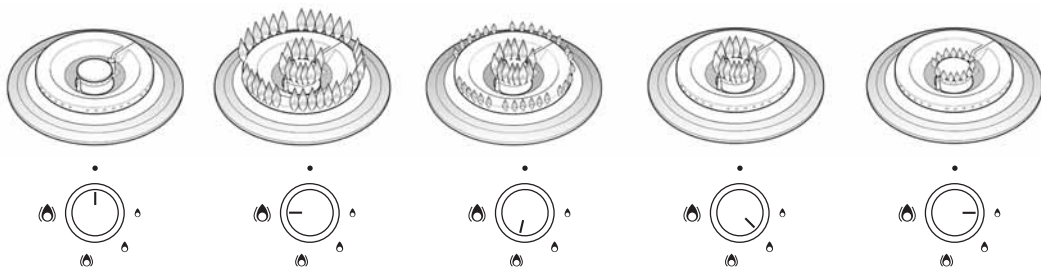

Important: If you just want to use the internal crown burner, turn the control knob until the indicator is lined up with (flame in a circle), then press the control knob into the control panel. The external crown burner automatically switches off. When you wish to turn the gas burner off, just turn the control knob until the indicator points to the ●.

Practical advice on how to use the burners

Read these instructions to get the best out of your burners:

- Use pans with a diameter the same as the burner (see pan diameter table to the side).
- Only use flat bottom pots and pans.
- Use the right amount of water for cooking food and use the lid.

Important: using the pan supports incorrectly will scratch the hob top: avoid placing them upside down or dragging them across the hob.

You should never use:

- Cast iron or steatite stone grills, terracotta pots or pans.
- Convector such as metal netting or other.

- The use of two burners simultaneously with just one container such as a fish kettle.

Failure comply with these recommendations could lead to your glass ceramic hob being damaged, or broken and/or the safety of your equipment being compromised.

Burner	Pan diameter
both crowns	from 24 to 26 cm
only the internal crown	from 8 to 14 cm

IMPORTANT

To get the most out of your burner as well as its flexibility, use it in the positions shown in the flame regulation symbols indicated in the diagrams above. The button positions corresponding with the continuous sections in the diagram to the right shows maximum functioning areas and make the most of the burner's capacity.

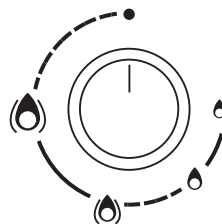

Injectors table

Category I12H3+

Type of gas used	Type of burner	Injector marking	Injector distance (X) mm	Injector distance (Y) mm	Nominal heat flow kW	Nominal consumption	Reduced heat flow kW	Gas pressure (mbar)		
								min.	nom.	max
NATURAL GAS (Methane) G20	Dual crown	140 + 34	7,5	-	4,20	400 l/h	1,70	17	20	25
	Internal crown	34	-	open	0,50	48 l/h	0,25			
GAS LIQUID PETROLEUM (Butane) G30	Dual crown	86 + 13	11	-	3,78	275 g/h	1,70	20	28-30	35
	Internal crown	13	-	open	0,45	33 g/h	0,25			
GAS LIQUID PETROLEUM (Propane) G31	Dual crown	86 + 13	11	-	3,78	270 g/h	1,70	25	37	45
	Internal crown	13	-	open	0,45	32 g/h	0,25			

Type of gas used	Configuration model	Heat flow nominal kW	Total consumption nominal	Required air (m³) for the combustion of 1 m³ of gas
G20 20 mbar	3 burners	12,60	1200 l/h	9,52
G30 28-30 mbar	3 burners	11,34	825 g/h	30,94
G31 37 mbar	3 burners	11,34	810 g/h	23,80

Electrical: 230 V - 50 Hz - 3,6 kW Type PLMFT

Induction zone functions

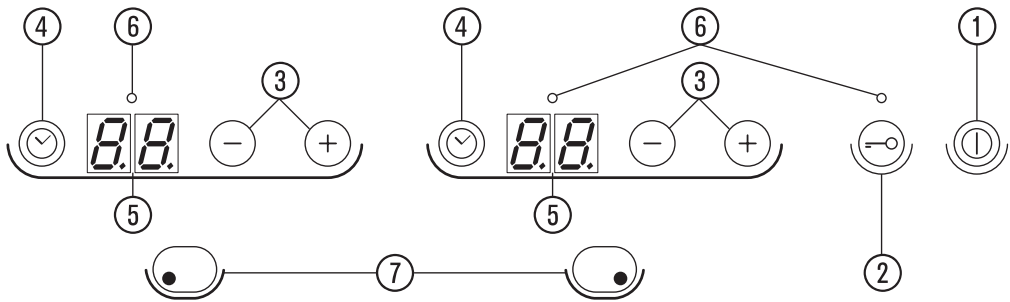

This hob is fitted with 2 induction zones that allow you to boil water very quickly, as well as control the temperature with extreme precision, giving you a vast range of cooking options. The induction zone control panel has the following functions.

1. On/off touch pad control
2. Child safety lock
3. Zone selection/ power level adjustment
4. Timer switch
5. LED display
6. LED indicator
7. Induction zone indicator symbol

IMPORTANT

Use pans made of a material suitable for induction cooking. See the chapter on “General precautions and recommendations” on P9.



To use the induction zones on your hob press button (1) for 2 seconds. The two displays (5) will show the number 0. If the induction zone is not selected within 10 seconds the zone will automatically switch itself off for safety purposes. Select the zone you wish to use by pressing one of the buttons (3). If you press the + button, the zone selected will automatically switch on with the power set at 5. If, however you press the - button the zone is automatically switched on with the power level set at 10. The power level can then be adjusted up or down from 1 to 10 using the buttons (3) as required. Pressing the + and - buttons simultaneously turns off the induction zone.



The **child safety** option can be turned on by pressing the button (2) until the illuminated point above the button with the key symbol (2) comes on. This option blocks all the buttons with the exception of the **on/off button** (1). The option will stay on even after the cooktop has been turned off and on again and can be disabled by pressing the button (2) again until the light above the button disappears.

Should there be a power cut or a failure in the distribution network, the option will turn off.



The **timer switch option** can be used both as a timer and to programme how long each zone will stay on for. In order to programme a zone using the timer option, just select the zone using the +/- buttons (3) and the power level required. Activate the timer option by pressing the button with the clock symbol (4) located to the side of each display. LED (6) showing the selected zone will flash above the selected zone's display. The display will show **00**. Set the required cooking time (1 min to 99 mins) within 10 seconds using the +/- buttons (3). After 10 seconds the timer option start automatically and the red control light (6) will stay on, whilst the display will show the power setting. Alternatively if the 10 seconds have not elapsed start the timer by pressing the clock symbol button (4) again. Once you have programmed the timer, you can change the power level selected using the +/- buttons (3). Pressing the clock symbol button will show the time remaining.

Induction zone functions

The time remaining can also be changed by pressing the clock symbol button (4) at any time and using the +/- buttons (3) to alter the time. The light above the display will flash for 10 seconds, then the display will show the amended time remaining. When the programmed time expires a continuous double signal will be heard. If a zone has been programmed using the timer option when the time expires the zone and the zone indicator will automatically switch off. You do not have to select a power level when using the timer option. The timer is activated by pressing the clock button (4). The timer option can be set on the induction zone that is not being used.



The **Lo option: heat maintenance** is an option that allows you to keep cooked food hot. Turn it on using the button (3) by lowering the selection below level 1 on either of the rings. It can be set at maximum for 120 mins.



The **P option or fast boil**: an option that sets a level of power greater than the maximum level (10) in order to bring water to the boil very quickly. Select it by pressing the + button (3), increasing the power level above 10.

This option can be used on both induction zones, but can only be used twice per zone in any 60 minute period.

Warning, when using the Fast Boil option (P) and high levels of power, especially if both zones are being used simultaneously, the appliance may become noisy.



Indication of residual heat. After turning the ring off, an "H" will be displayed until the temperature of the hob falls to an acceptable temperature, usually below 65°C.

IMPORTANT: the hob's safety equipment includes an automatic shut off function. Prolonged use of the same power setting will switch off the induction zone (for example after about 1 hour at maximum power level, the zone will turn off).

IMPORTANT: do not use pots or pans with a diameter greater than 14 cm on the induction rings.

Please read all the instructions carefully and keep them in a safe place.

Positioning the pan supports and Wok support

Position the pan supports by inserting them in the slot inside the gas ring. To use the wok support provided, position it as shown in the diagram.



Sizes and installation measurements (mm)

NOTE: If a hood is installed above the hob, read the instructions for fitting the hood where it indicates the correct distances to be complied with.

- The cooktop has to be set into a work top between 20 - 40 mm deep.
- The distance between the lower face of the glass ceramic hob and the cupboard or separating panel must comply with the sizes shown in diagram "A".
- If a column unit has to be installed next to the cooktop, leave a distance of at least 100mm from the edge of the cooktop.
- Cut an opening in the worktop as per the dimensions indicated in the enclosed product description sheet.
- Apply the supplied gasket around the cooktop (unless it has already been installed), after cleaning the surface.

Important

In order to prevent the electronic circuits overheating and becoming damaged, we recommend the following:

- do not install the cooktop near a dishwasher or washing machine, to prevent the electronic circuits coming into contact with steam or moisture which could damage them.

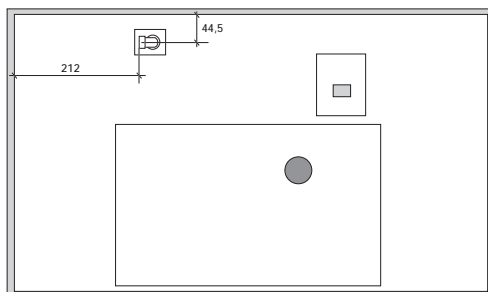
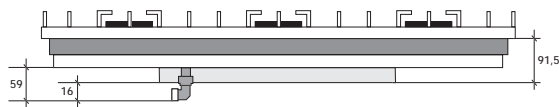
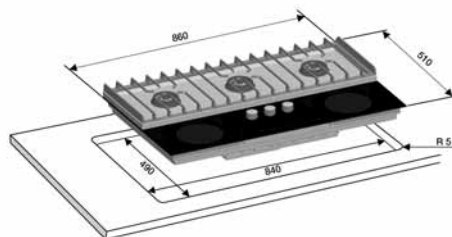
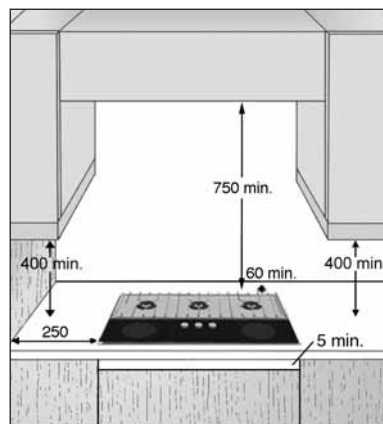
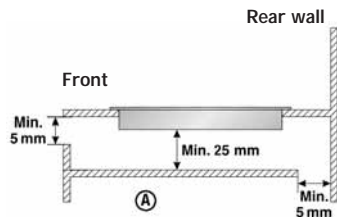

Precautions and general recommendations

To get the best out of your hob, please read the instructions carefully and keep them for future consultation.

- These instructions are only valid in the countries whose symbol of destination is shown on the product description sheet and hob.
- The packaging (plastic bags, expanding polyurethane, etc.) poses a potential source of danger to children and should be kept out of their reach.
- Check that the product has not been damaged during transport and remove any protective film from the appliance parts.
- **This hob (cat. 3) was designed to be used exclusively for cooking food in household surroundings. Any other use (for example heating rooms) should be regarded as improper and dangerous.**
- **Make sure that the installation and gas/electrical connections are carried out by a qualified electrician in compliance with legislation in force locally.**
- **This appliance should be installed in compliance with standards in force and only used in well aired rooms. Read the instructions before installing and using this appliance.**
- **The pre-fitted gas and its corresponding supply pressure are shown on the label attached to the bottom of the hob. If the fitting has to be changed, see the paragraph on "Adaptation to different kinds of gas".**

In the event of prolonged usage, additional ventilation may be required (opening a window or increasing the suction strength of the hood). Each time you finish using the hob, always check that the control buttons are in the off position and shut off the tap to the gas mains or cylinder.

Warning: the accessible parts become very hot when the appliance is on. Keep children away from the appliance to prevent scalding or burning.

The appliance should not be used by children or the infirm unless supervised.

Make sure children do not play with the appliance.

- Before doing any maintenance work on the appliance, disconnect it from the electrical power supply.
- Keep children away from the appliance when it is in use and when it has just been switched off.

- The appliances should only be repaired or adjusted by a qualified electrician.
- Make sure the electrical wires of other electrical appliances do not come into contact with hot parts.
- The induction zones will not switch on if the pan is not either the right size, or do not attract a magnet. Use a magnet to check. If the magnet sticks to the bottom of the pan then it is magnetic and can be used. If the pan is taken off the cooking area, the zone will switch off and a "U" is shown in the display. This will disappear when the pan is replaced back on the cooking zone.
- Avoid the use of high pressure water or steam cleaning equipment.
- If liquids spill or boil over, the hob may switch off. In order for it to be switched back on again, carefully dry the control panel area.
- Metal objects such as knives, forks, spoons or pan lids should not be placed on the cooking surface as they could activate the induction zone and become hot.

To avoid permanently damaging the glass ceramic hob, do not use:

- pots with bottoms that are not perfectly flat;

- metal pots with enamel bottoms.

- When finished cooking, press the button .
- Do not use the cooktop as a work or support surface.
- Do not leave the appliance unattended when frying – risk of fire.
- If the glass ceramic surface should break or crack due to a violent impact (falling objects etc.), disconnect the appliance from the electrical power supply and contact the Customer Care Centre immediately.
- Do not place food wrapped in aluminium foil, plastic containers or cloths on the hot rings.
- Do not drag pots across the glass ceramic surface – risk of scratching.
- Avoid spilling sugar or other substances on the surface. If necessary, clean the surface immediately, following the cleaning and maintenance instructions in this manual.
- Never heat a tin or can with food in it.

Safeguarding the environment

Packing

The packaging material is 100% recyclable and is labelled with the recycling symbol  that identifies it as a kind of material to be sent to local waste disposal centres.

Product

This appliance is marked according to the European Directive 2002/96/EC, Waste Electrical and Electronic Equipment (WEEE).

By ensuring that this product is disposed of correctly, you will help prevent potentially negative consequences for the environment and human health.

The symbol  on the product or on the documents accompanying the product indicates that this appliance should not be treated as household waste. Instead, it should be handed over to the applicable collection point for the recycling of electrical and electronic equipment. Disposal must be carried out in accordance with local environmental regulations for waste disposal. For more detailed information on treatment, recovery and recycling of this product, contact your local authority, the household waste disposal service or the shop where you purchased the product.

Conformity declaration

This hob was designed, built and marketed in compliance with:

- the safety requirements in the "Gas" CEE Directive 90/396.
- the safety requirements in the "Low Voltage" CEE Directive 73/23
- the protection requirements of the "EMC" CEE Directive 89/336
- the requirements in CEE Directive 93/68.
- this hob can come into contact with food and complies with CEE Directive 89/109.

Note:

- Improper use of the pan supports can scratch the hob surface. Avoid placing them, or dragging them if unprotected by rubber stoppers.
- On glass surfaces, do not use:
 - Cast iron griddles, terracotta pots or pans.
 - Heat convectors (e.g. metal netting).
 - Two burners for cooking with one pan (e.g. fish kettle).
- In the event of prolonged usage, additional ventilation may be required (opening a window or increasing the suction strength of the hood).

Warning

- Keep children away from the hob when it is on and don't let them play with the buttons or any other part of the appliance.
- The rubber protection stoppers under the grills could be swallowed by small children and cause suffocation.
- After removing the pan supports, make sure that all the rubber stoppers are in place on the pan supports.
- **Each time you finish using the hob, always check that the control buttons are in the off position and shut off the tap to the gas mains or cylinder.**
- Do not obstruct the air vents at the back of the appliance in any way.

Installation

Technical information for the installer

- This product can be built into a 20 to 40 mm deep worktop.
- The hob cannot be installed with an oven underneath. Always insert a separator panel under the hob at a distance of no less than 25 mm from the lowest point (electronic control module) on the appliance. Follow the measures shown in the "Sizes and installation measurements (mm)" section.

Before installation, make sure that:

- The local gas mains (type and pressure) and the calibration on the hob are compatible (see serial no. plaque and interior table).
- The covering on the walls of the appliance or appliances next to the hob are heat resistant in compliance with local regulations.
- The combustion smoke is released via proper suction hoods or electrical fans installed on the walls and/or windows.
- The air circulates naturally through a suitable opening that is no less than 100 cm² of practicable section, which must be:
 - Permanent and accessible on the walls of the room being ventilated and extracting towards the outside
 - Created in such a way that the openings, both inside and out, cannot be obstructed, not even by mistake
 - Protected by plastic grills, metallic netting etc. that, under no condition, should reduce the practicable section indicated above
 - Located close to the floor and placed in such a way that it does not interfere with the extraction of the combustion smoke.

Gas connection

The gas mains system must comply with local regulations.

- The paragraph on “national legislation reference” shows the local legislation specific to the country of destination.
- Should there be no information regarding your country of interest, ask for further details from the installer.
- The connection of the hob to the gas mains network or gas cylinder must be done using a rigid copper or steel pipe with parts that comply with local standards, or using a flexible stainless steel pipe with continuous surfaces that comply with local standards. The flexible metallic pipe should be no longer than 2 linear metres.
- Before connecting the pipe with the rubber part **(A)**, insert the seal **(B)** provided, that complies with **EN 549**.

Warning: if you use a stainless steel flexible pipe, it must be installed in such a way that it does not come into contact with moving cabinetry like drawers or kitchen cupboards and passes at a point free of obstacles where it can be examined in its entirety.

- After connecting to the gas mains, use soap and water to check there are no leaks.

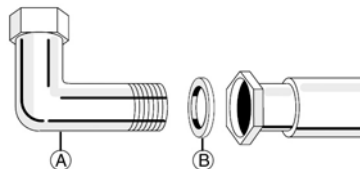

Electrical connection

The electrical connections must comply with local standards.

- Information on the voltage and power absorbed are shown on the serial no. plaque.
- The appliance must be earthed by law.
- When installing the appliance you must make sure there is a multipolar switch with contact opening equal or greater than 3mm.
- If necessary, the power cable must be replaced exclusively with a cable that is identical to the original one provided (H05V2V2-F T90°C or H05RR-F type). Please contact the Customer Care Centre.
- Do not use extension cables.
- **The manufacturer declines all responsibility for damage to persons, pets or goods as a result of failure to comply with the regulations above.**

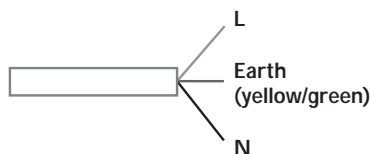

Securing the hob into cabinetry

1. After cleaning the surfaces around the edges, fit the seal provided around the hob.
2. Position the hob inside the opening according to the sizes indicated in the description sheet.
3. Use the brackets **(A)** provided to secure the hob, fixing it with the proper screws to adapt it to the thickness.

Warning: the electrical power cable must be long enough to allow the hob to be lifted out from above.

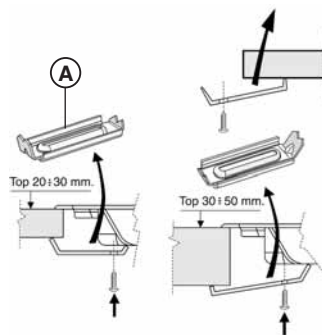

Adaption to different kinds of gas

If you are using a different kind of gas from the one indicated on the serial no. plaque and the orange label on the back of the hob, you must replace the injectors; in the case of the Wok burner, adjust the primary air (see Injector table).

The orange label should be removed and kept together with the manual.

Use pressure regulators suitable for the gas pressure indicated in the description sheet.

- In order to replace the injectors, contact the Customer Care Centre or a qualified electrician.

- Injectors not supplied as standard should be requested from the Customer Care Centre.
- Regulate the minimum levels of the taps.

Note: With liquid petroleum gas (G30/G31) the by-pass screw must be screwed in deeply. If you then experience difficulty in turning the button, contact the Customer Care Centre who will arrange for the tap to be replaced after ascertaining that the tap is damaged.

Replacing the injectors

(See the product description sheet for model)

Remove the bottom of the hob, lifting out the installation brackets to change the dual crown wok burner injector. **Please contact the Customer Care Centre.**

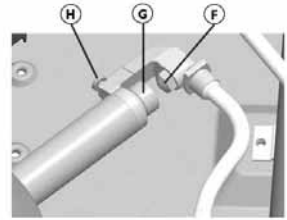

REMOVING THE MAIN INJECTOR

Remove the injector (F) using a 10mm spanner. Slacken the holding screw (H) to regulate the position (X) of the gas inlet coupling (G) with regard to the injector.

REMOVING THE SECONDARY INJECTOR

Remove the injector (I) using a 12 mm spanner. There is no need to regulate the position (Y) of the gas inlet coupling (L) with regard to the injector. Leave it at end stroke, corresponding with the sizes shown in the injector table.



FITTING THE WOK BURNER

To fit the dual crown burner wok, insert in the following order: the burner ring (A), the decorative covering ring (B), the external burner cap (C) and the internal burner cap (D).

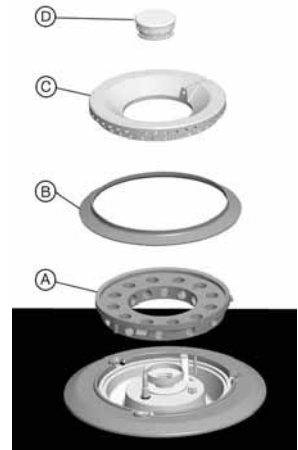

Regulating the minimum level of the taps

To ensure the minimum level is properly regulated, remove the handle and work on the screws found on the tap as follows:

- tighten to reduce the height of the flame (-)
- slacken to increase the height of the flame (+)

Regulating the minimum level must be done with the tap at the lowest position (small flame) 🔥 .

- There is no need to regulate the primary air in the burners.
- With the burners on, rotate the buttons from the maximum 🔥 to the minimum 🔥 to check the stability of the flame.

Once you have finished regulating, close up the seals again using sealing wax or similar.



General cleaning

In order to keep your hob in good condition, you must keep it clean, removing any food residue each time you use it.

Always disconnect the hob from the electrical power supply and wait until it cools before cleaning.

Cleaning the surface of the hob:

Stainless steel surfaces

- The stainless steel surface may become stained if it comes into contact with "hard" water for a long period of time, or with extremely strong, aggressive cleaning products. Always clean up spillages as quickly as possible (water, sauces, coffee etc). Wash with lukewarm water and a mild detergent, rinse then dry carefully with a soft cloth. Only clean very dirty surfaces with products specially designed for stainless steel.
- Do not use harsh or corrosive products, chloride based products or scourers.
- Do not steam clean.
- Do not use inflammable products.
- Do not leave acidic or alkaline based products like vinegar, mustard, salt, sugar or lemon juice on the hob.

Care and maintenance of the hob parts

The pan supports and gas burners can be removed for cleaning.

1. Hand wash carefully with hot water and a neutral cleaning product making sure you remove any ingrained dirt and ensuring that none of the openings on the burner is obstructed. The internal burner cap (D) on the WOK burner is made of real brass and is subject to natural burnishing when it heats up. Clean it each time you use it with a product specifically designed for brass.
Use hot water and a mild cleaning product to clean the external burner cap (C) Never use harsh products or scourers that could damage the special surface covering.
2. Rinse and dry carefully.
3. Correctly refit the burners and caps in their place.
4. Make sure when replacing the supports that the area for resting the pans is centred with the burner.

Note: in the models fitted with electronic ignition and safety thermocouples, you have to clean the terminal part very carefully to ensure they work properly.

Frequently check them and, if necessary, clean with a damp cloth.

Any remaining ingrained food should be removed with a toothpick or needle.

To avoid damaging the electronic ignition do not use it when the burners are not in their place.

Glass ceramic surfaces

Clean the cooking area after each use when it has cooled down. This will prevent the built up of dirt and make cleaning easier.

Important: Avoid the use of high pressure water or steam cleaning equipment.

- Use a clean cloth, kitchen roll and washing up liquid or a glass ceramic cleaner.
- Remove stubborn dirt with the scraper supplied and ceramic cleaning products.
- Food spills should be cleaned off the glass ceramic surface before they turn hard.
- Foods with high sugar content (toffee, fruit juice, marmalade, etc.) that boil over while cooking or spattered sugar stains resulting from cooking should be removed immediately using the scraper, or they may "etch" into the ceramic surface.
- Do not use harsh products, bleach, oven cleaner sprays or pan scourers.

The glass ceramic hob should be periodically treated with a proprietary brand of wax.

Important

Periodically check that dust does not gather on the apparatus near the air cooling inlet or outlet openings. This might obstruct ventilation and the electronic cooling system and reduce the cooktop's efficiency.

Troubleshooting guide

The hob is not working properly or not working at all. Before calling the Customer Care Centre, see if the problem you are encountering is mentioned in this guide.

Contact the Customer Care Centre to replace the power cable.

Burners and gas rings

1. The burner doesn't come on or the flame is uneven. Check that:

- the gas or electricity supply is not interrupted and, in particular, that the main gas tap at source on the hob, is open;
- the gas cylinder has not run out;
- the gas outlet openings to the burner have not been obstructed;
- the end part of the ignitor isn't dirty;
- all the parts on the burner are properly positioned; there is not a draft near the hob.

2. The flame doesn't stay on. Check that:

- the button was pushed in properly when turning on the burner for the time required to activate the safety thermocouple;
- the burner's openings are not obstructed in relation to the thermocouple;
- the end part of the thermocouple isn't dirty;
- the minimum level is correctly regulated (see relevant paragraph P14).

3. The pots are instable. Check that:

- the bottom of the pot is perfectly flat.
- the pot is centred on the burner.
- the pan supports have not been inverted or positioned incorrectly.

If, after checking all the above, the hob is still giving you problems, call your Customer Care Centre.

Induction rings

Cooktop not working

- When pressing the control buttons, follow the instructions in the section "Using the hob".
- Is there a power failure?
- Did you dry the hob carefully after cleaning it?

1. If a ring is selected or "E" or "ER" appear on the display, contact the Customer Care Centre and tell them about the E or ER on the display.

2. If one of the following codes appears when you press the ignition button on the hob: ER31, ER47, ER36, ER39, ER20, ER37, ER22, E5, E6, E7, E9 contact the Customer Care Centre and tell them about the code that is appearing on the display.
3. If the hob does not work after intensive use, it means that the temperature inside the hob is too high. In this case E2 appears on the display. Wait for a few minutes until the hob cools down.
4. If the control shows that one or more of the buttons has been pushed in for too long, the symbol  will appear. This message may also be the result of objects being improperly positioned on the control area, or left over food. Clean the control area carefully.

Important!

If you cannot manage to turn off the glass ceramic hob after using it, unplug the socket immediately and contact the Customer Care Centre.

Cooling fan

The cooktop is fitted with a dual speed cooling fan, regulated by the temperature inside the hob. If the latter reaches a certain temperature, greater than the power of all the cooking plates, cooking power automatically reduced or, if necessary, the entire cooktop is disabled. Once the cooktop internal temperature is back within limits the cook top is re-enabled. The cooling fan may continue to run for a short period of time even after the hob has been turned off.

After Sales Service

Before contacting the Customer Care Centre, clarify that you cannot resolve the problem yourself based on the descriptions given in the "Troubleshooting guide".

1. Turn the apparatus off and restart it to see if the fault is repeated.

If after carrying out the above checks, the fault persists, contact your Customer Care Centre.

Please give:

- a short description of the fault
- the precise type and model of the hob
- the service number (the number after the word Service on the date plate), located under the hob. The service number can also be found in the warranty booklet
- your full address
- your telephone number.

Note: failure to comply with these instructions could seriously compromise the safety and quality of the hob.



Printed in Italy
01/07

5019 719 01020



Free Manuals Download Website

<http://myh66.com>

<http://usermanuals.us>

<http://www.somanuals.com>

<http://www.4manuals.cc>

<http://www.manual-lib.com>

<http://www.404manual.com>

<http://www.luxmanual.com>

<http://aubethermostatmanual.com>

Golf course search by state

<http://golfingnear.com>

Email search by domain

<http://emailbydomain.com>

Auto manuals search

<http://auto.somanuals.com>

TV manuals search

<http://tv.somanuals.com>