

KitchenAid™

ARTISAN™ FOODPROCESSOR
INSTRUCTIES EN RECEPTEN

ARTISAN™ FOOD PROCESSOR
INSTRUCTIONS AND RECIPES

ROBOT MÉNAGER ARTISAN™
MODE D'EMPLOI ET RECETTES

ARTISAN™ FOOD PROCESSOR
BEDIENUNGSANLEITUNG UND REZEPTE

FOOD PROCESSOR ARTISAN™
ISTRUZIONI PER L'USO E RICETTE

**PROCESADOR DE
ALIMENTOS ARTISAN™**
INSTRUCCIONES Y RECETAS

ARTISAN™ MATBEREDARE
INSTRUKTIONER OCH RECEPT

ARTISAN™ FOODPROSESSOR
BRUKSANVISNING OG OPPSKRIFTER

ARTISAN™ MONITOIMIKONE
KÄYTTÖOHJEET JA RESEPTIT

ARTISAN™ FOOD PROCESSOR
INSTRUKTIONER OG OPSKRIFTER

**PROCESSADOR DE
ALIMENTOS ARTISAN™**
INSTRUÇÕES E RECEITAS

ARTISAN™ MATVINNSLUVÉL
LEIÐBEININGAR OG UPPSKRIFTIR

ARTISAN™ KOYZINOMHXANH
ΟΔΗΓΙΕΣ ΚΑΙ ΣΥΝΤΑΓΕΣ

English



Models 5KFPM776 (shown),
5KFPM771, 5KFPM775
(not shown)

Table of Contents

Food Processor Safety	3
Electrical Requirements	3
Important Safeguards	4
Food Processor Features	5
Preparing the Food Processor for Use	
Before First Use	7
Work Bowl Assembly	7
Multipurpose Blade & Dough Blade Assembly	8
Slicing & Shredding Disc Assembly	8
Mini Bowl Assembly	9
Chef's Bowl Assembly	9
Egg Whip Assembly & Use	10
Citrus Press Assembly & Use	10
Using the Food Processor	
Before Use	12
Food Pusher Interlock	12
Maximum Liquid Level	12
Turning the Food Processor On and Off	12
Using the Pulse Control	13
2-Piece Food Pusher	13
Disassembling the Food Processor	13
Care and Cleaning	15
Troubleshooting	16
Food Processing Tips.....	17
Using the Multipurpose Blade.....	17
Using a Slicing or Shredding Disc	18
Using the Dough Blade.....	19
Using the Egg Whip	19
Helpful Hints.....	20
Recipes	22
Warranty and Service Information	
Household KitchenAid™ Food Processor Warranty.....	27
Service Centers	27
Customer Service	28

Food Processor Safety

Your safety and the safety of others are very important.

We have provided many important safety messages in this manual and on your appliance. Always read and obey all safety messages.



This is the safety alert symbol.

This symbol alerts you to potential hazards that can kill or hurt you and others.

All safety messages will follow the safety alert symbol and either the word "DANGER" or "WARNING." These words mean:

⚠ DANGER

You can be killed or seriously injured if you don't immediately follow instructions.

⚠ WARNING

You can be killed or seriously injured if you don't follow instructions.

All safety messages will tell you what the potential hazard is, tell you how to reduce the chance of injury, and tell you what can happen if the instructions are not followed.

Electrical Requirements

Models 5KFPM771, 5KFPM775, 5KFPM776:

230-240 Volts A.C.
Hertz: 50 Hz

NOTE: Models 5KFPM771, 5KFPM775 and 5KFPM776 have a grounded plug. To reduce the risk of electrical shock, this plug will fit in an outlet only one way. If the plug does not fit in the outlet, contact a qualified electrician. Do not modify the plug in any way.

Do not use an extension cord. If the power supply cord is too short, have a qualified electrician or serviceman install an outlet near the appliance.

⚠ WARNING



Electrical Shock Hazard

Plug into a grounded 3 prong outlet.

Do not remove ground prong.

Do not use an adapter.

Do not use an extension cord.

Failure to follow these instructions can result in death, fire or electrical shock.

IMPORTANT SAFEGUARDS

When using electrical appliances, basic safety precautions should always be followed, including the following:

1. Read all instructions.
2. To protect against risk of electrical shock do not put Food Processor in water or other liquid.
3. Unplug from the outlet when not in use, before putting on or taking off parts, and before cleaning.
4. Avoid contacting moving parts.
5. Do not operate any appliance with a damaged cord or plug, or after the appliance malfunctions, or is dropped or damaged in any manner. Return appliance to the nearest Authorized Service Facility for examination, repair, or electrical or mechanical adjustment.
6. The use of attachments not recommended or sold by the manufacturer may cause fire, electric shock or injury.
7. Do not use outdoors.
8. Keep hands and utensils away from moving blades or discs while processing food to reduce the risk of severe injury to persons or damage to the Food Processor. A scraper may be used but must be used only when the Food Processor is not running.
9. Blades are sharp. Handle carefully.
10. To reduce the risk of injury, never place cutting blade or discs on base without first putting bowl properly in place.
11. Be certain cover is securely locked in place before operating appliance.
12. Never feed food by hand. Always use the food pusher.
13. Do not attempt to defeat the cover interlock mechanism.
14. This product is designed for household use only.
15. This appliance is not intended for use by persons (including children) with reduced physical sensory or mental capabilities, or lack of experience and knowledge, unless they have been given supervision or instruction concerning use of the appliance by a person responsible for their safety.
16. Children should be supervised to ensure that they do not play with the appliance.
17. Switch off the appliance and disconnect from supply before changing accessories or approaching parts that move in use.

SAVE THESE INSTRUCTIONS

This appliance is marked according to the European directive 2002/96/EC on Waste Electrical and Electronic Equipment (WEEE).

By ensuring this product is disposed of correctly, you will help prevent potential negative consequences for the environment and human health, which could otherwise be caused by inappropriate waste handling of this product.



The symbol  on the product, or on the documents accompanying the product, indicates that this appliance may not be

treated as household waste. Instead it shall be handed over to the applicable collection point for the recycling of electrical and electronic equipment.

Disposal must be carried out in accordance with local environmental regulations for waste disposal.

For more detailed information about treatment, recovery and recycling of this product, please contact your local city office, your household waste disposal service or the shop where you purchased the product.

Food Processor Features*



Work Bowl Cover with Ultra Wide Mouth Feed Tube

One of the industry's largest, the ultra wide mouth feed tube accommodates large items – like tomatoes, cucumbers, and potatoes – with a minimum of sectioning or slicing.



2-Piece Food Pusher

For smaller items, remove the small pusher from the central tube in the large pusher. The small pusher and feed tube make it easy to process herbs, nuts, single carrots and celery. The small pusher can also be used as a convenient 115 ml measuring cup.



2.8-Liter Work Bowl

The tough polycarbonate bowl provides capacity for large jobs.



Chef's Bowl

(included only with model 5KFPM776)

Place the 2.4 liter Chef's Bowl inside the Work Bowl, and slice or shred a food item while keeping the Work Bowl clean for another ingredient.



Mini Bowl and Mini Blade

950 ml bowl and stainless steel blade are perfect for small chopping and mixing jobs.



Fine (2 mm) Slicing Disc

Disc produces approximately 1.6 mm slices of most foods, from delicate strawberries to partially frozen meats.



Medium (4 mm) Slicing Disc

Disc produces approximately 3.2 mm slices of most foods.

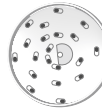

Medium (4 mm) Shredding Disc

Disc produces approximately 3.2 mm shreds of most firm fruits, vegetables, and cheese.



Julienne Disc

(included with models 5KFPM775 and 5KFPM776)

Slices potatoes, carrots, zucchini, summer squash, and other firm fruits and vegetables into true 3.5 mm x 2.5 mm julienne matchsticks.

* Depending on the model you have purchased, some features shown may not be included.

Food Processor Features*



Disc Stem

Stem fits over the power shaft on the base and into the bottom of a slicing or shredding disc.



Stainless Steel Multipurpose Blade

Versatile blade chops, minces, blends, mixes, and emulsifies in a matter of seconds.



Dough Blade

The dough blade is specially designed for mixing and kneading yeast dough.



Egg Whip

The egg whip will quickly whip cream and egg whites for meringues, mousses, soufflés, and desserts.

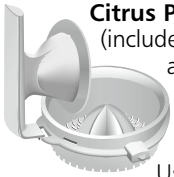

Citrus Press

(included with models 5KFPM775 and 5KFPM776)

Press consists of a Strainer Basket, 2-Piece Cone, and Lever Arm.

Use the removable outer

cone for larger items, such as grapefruit, and the inner cone for lemons and limes.



Heavy-Duty Base

The base features the "O", "I", and Pulse Buttons along with the power shaft, which rotates the blades and discs.

Spatula/Cleaning Tool

Special shape facilitates food removal from bowls, discs, and blades.



Chef's Accessory Case

Stylish and durable slim-line case organizes and protects blades, discs, and accessories

The accessory case included with models **5KFPM775** and **5KFPM776** is designed to hold up to five discs. If an additional disc is purchased, it can be stored in the case with the original four discs included with these two models.

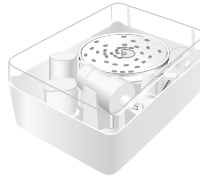

5KFPM771

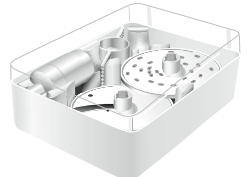

5KFPM775 & 5KFPM776

* Depending on the model you have purchased, some features shown may not be included.

Preparing the Food Processor for Use

WARNING

Cut Hazard

Handle blades carefully.

Failure to do so can result in cuts.

Before First Use

Before using your Food Processor for the first time, wash the work bowl, work bowl cover, chef's bowl, mini bowl, feed tube pushers, discs, and blades either by hand or in the dishwasher (see "Care and Cleaning" on page 15).

Work Bowl Assembly

1. Place the Food Processor base on a dry, level countertop with the controls facing forward. Do not plug in the unit until it is completely assembled.
2. With the handle just to the left of center, place the work bowl on the base, fitting the center opening over the power shaft.
3. Grasp the work bowl handle and turn the bowl to the right until it locks into position.



4. Insert the desired accessory into the work bowl. See pages 8–11 for accessory instructions.
5. Place the work bowl cover on the work bowl with the feed tube just to the left of the work bowl handle. Grasp the feed tube and turn the cover to the right until it locks into place.

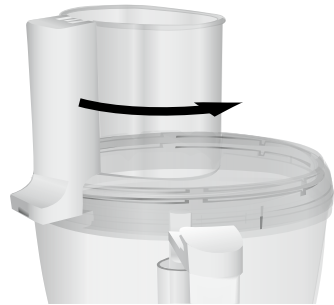

NOTE: To avoid damage to the work bowl, do not attach the cover to the work bowl before the work bowl is locked on to the base.

6. Fit the 2-piece food pusher into the feed tube.



Preparing the Food Processor for Use

WARNING



Electrical Shock Hazard

Plug into a grounded 3 prong outlet.

Do not remove ground prong.

Do not use an adapter.

Do not use an extension cord.

Failure to follow these instructions can result in death, fire or electrical shock.

7. Plug into a proper electrical outlet (see "Electrical Requirements" on page 3).

NOTE: Your Food Processor will not operate unless the work bowl and work bowl cover are properly locked on the base, and the pusher is inserted to the maximum fill line on the feed tube.

To avoid damage to the work bowl, do not remove the work bowl from the base without first removing the work bowl cover.

WARNING

Cut Hazard

Handle blades carefully.

Failure to do so can result in cuts.

Multipurpose Blade and Dough Blade Assembly

Place the blade on the power shaft. Rotate the blade so it falls into place on the shaft.



Slicing and Shredding Disc Assembly

1. Place the disc stem on the power shaft.



Preparing the Food Processor for Use

WARNING

Cut Hazard

Handle blades carefully.

Failure to do so can result in cuts.

2. Fit the disc over the metal pin on the disc stem with the raised-blade side up. The disc has a raised nub on the top and grooves underneath to help align it properly. Rotate the disc until it falls fully onto the stem.



Mini Bowl Assembly

1. Place the mini bowl inside the work bowl over the power shaft. Rotate the mini bowl until it falls into place. When properly seated in the work bowl, the mini bowl cannot be rotated.



2. Fit the mini blade on the power shaft. It may be necessary to rotate the blade until it falls into place. The mini bowl can also be placed in the chef's bowl in a similar manner.



3. To remove the mini bowl after processing, lift the bowl using the two finger grips located along the top edge of the bowl.



Chef's Bowl Assembly (5KFPM776)

Place the chef's bowl inside the work bowl over the power shaft. Rotate the chef's bowl until it falls into place. When properly seated in the work bowl, the chef's bowl cannot be rotated.

The chef's bowl can only be used with the slicing and shredding discs – the multipurpose blade cannot be used. To remove the chef's bowl after processing, lift the bowl using the two finger grips located along the top edge of the bowl.

Preparing the Food Processor for Use

Egg Whip Assembly and Use

The egg whip is designed to whip egg whites or heavy cream to create toppings or soft meringues. For the best results, at least 237 ml (125 g/1 cup) of heavy cream or 3 egg whites should be whipped at a time. Whipping smaller quantities may not result in maximum volume.

To assemble:

The egg whip consists of 4 pieces – the egg whip stem, stem cover, whip paddle, and cap.

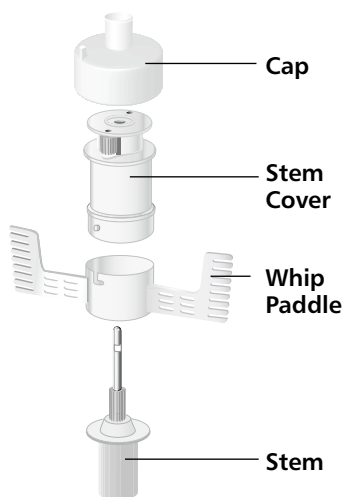

1. Place the egg whip stem on the power shaft. Slowly turn the stem until it drops fully onto the shaft.
2. Align the L-shaped notch on the whip paddle with the small post on the stem cover, and slide the paddle onto the cover. Turn slightly to lock paddle.
3. Fit the stem cover and paddle over the egg whip stem. Push downward to engage the ridges of the stem with the gears of the paddle.
4. Fit the egg whip cap over the egg whip stem. Push downward to lock it into place.

5. Place the work bowl cover on the work bowl with the feed tube just to the left of the handle. Make sure the center pin of the egg whip fits into the center opening of the cover. Grasp the feed tube and turn the cover to the right to lock it into place. Insert the pusher into the feed tube. The egg whip is now ready to operate.
6. Press the "I" Button and whip ingredients to the desired texture and volume. Press the "O" Button when finished.

To disassemble:

1. Unplug the base from the electrical outlet. Remove the work bowl cover with a clockwise turn.
2. Lift the egg whip assembly off the power shaft. Remove whipped ingredients from the work bowl.
3. Pull the cap from the egg whip assembly. Push downward on the stem pin to remove stem from the stem cover. Turn the egg whip paddle to unlock, and slide the paddle from the stem cover.

Citrus Press Assembly and Use (5KFPM775 and 5KFPM776)

1. Position and lock the work bowl on the base.
2. Place the strainer basket in the bowl with the locking clip to the left of the work bowl handle.
3. Turn the basket counter-clockwise until the clip locks into the handle.



Preparing the Food Processor for Use

- The 2-piece cone offers two sizes; choose the right size for the fruit you are juicing. Use the outer cone for grapefruit, oranges and other large fruits. Remove the outer cone to reveal a smaller inner cone that's perfect for lemons and limes.
- Open the lid and place the cone inside the strainer basket over the power shaft. It may be necessary to rotate the cone until it falls into place.

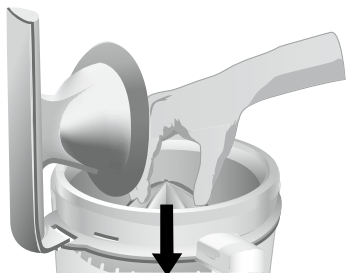

- Halve the fruit to be juiced.
- Place fruit half on cone.
- Close the lid of the strainer basket. Hold the lever arm down firmly with an open palm to maintain even pressure. Operate the citrus press only when the lever arm is in the down position, holding the fruit on the cone.



NOTE: Use of the citrus press without the clip-on lever arm is not recommended. If you do use it without the lever arm, remove the lever arm from the basket (see step 14).

- Operate the citrus press by pressing the "I" Button or the "Pulse" Button.
- When juice is fully extracted, press the "O" Button.

NOTE: Do not exceed the maximum liquid level line (see page 12) on the work bowl, or juice will leak from the bowl.

- Unplug the Food Processor.
- Unlock the strainer basket by turning it clockwise. Remove juiced fruit, cone, and strainer basket from the work bowl.
- Remove the work bowl from Food Processor and pour juice into desired container.
- The lever arm can be unclipped from the strainer basket for thorough cleaning. To detach, pull the clip at the bottom of the basket away from the basket side and remove the lever arm from the basket.
- When reattaching the lever arm to the strainer basket, make sure the tab on the handle snaps securely into the slot on the basket.

Using the Food Processor

⚠️ WARNING



Rotating Blade Hazard

Always use food pusher.

Keep fingers out of openings.

Keep away from children.

Failure to do so can result in amputation or cuts.

Before Use

Before operating the Food Processor, be sure the work bowl, blades, and work bowl cover are properly assembled on the Food Processor base (see "Preparing the Food Processor for Use" starting on page 7).

Food Pusher Interlock

The large food pusher is part of the safety interlock system. The Food Processor will not run unless the large pusher is inserted to the maximum fill line on the feed tube.

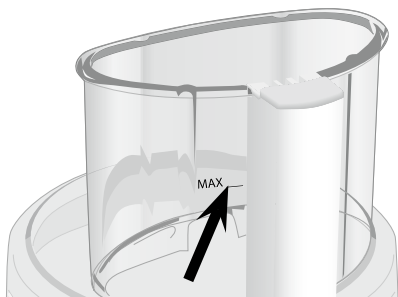

For continuous operation, insert the large pusher completely into the ultra wide mouth feed tube and use the small food pusher (see page 13 for a complete description).

Maximum Liquid Level

This line on the work bowl indicates the maximum level of liquid that can be processed by the Food Processor.

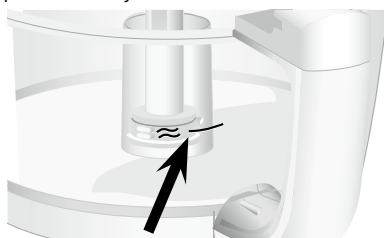

Turning the Food Processor "I" and "O"

1. To turn on the Food Processor, press the "I" Button. The unit will run continuously and the indicator light will glow.



2. To stop the Food Processor, press the "O" Button. The indicator light will go out and an automatic brake will stop the action of the blade or disk within seconds.
3. Wait until the blade or disk comes to a complete stop before removing the work bowl cover. Be sure to turn off the Food Processor before removing the work bowl cover, or before unplugging the Food Processor.

NOTE: If the Food Processor fails to operate, make sure the work bowl and cover are properly locked on the base, and the food pusher is inserted to the maximum fill line on the feed tube (see "Preparing the Food Processor for Use" starting on page 7).

Using the Food Processor

Using the Pulse Control

The pulse control allows precise control of the duration and frequency of processing. It's great for jobs which require a light touch. Just press and hold the "Pulse" Button to start processing, and release it to stop. The indicator light will glow each time the "Pulse" Button is pressed.



2-Piece Food Pusher

The 2-Piece Food Pusher

For continuous processing of smaller items, insert the 2-piece food pusher into the feed tube, then turn the small center pusher clockwise to unlock

and remove. Use the center feed tube and pusher to process small or slender items, or to add liquid while the Food Processor is running. When not using the small feed tube, lock the small pusher into place by turning it counter-clockwise.

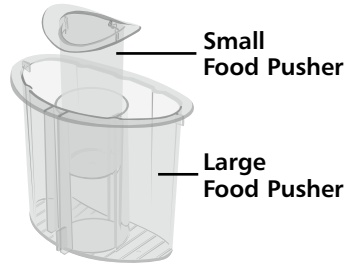

Small Food Pusher

Large Food Pusher

Disassembling the Food Processor

WARNING

Cut Hazard

Handle blades carefully.

Failure to do so can result in cuts.

NOTE: If you have difficulty removing the pusher from the feed tube, it is likely that food particles have become lodged in the interlock system. To free the pusher, soak the work bowl cover in warm water or wash it in a dishwasher.

1. Press the "O" Button.
2. Unplug the Food Processor before disassembling.
3. Turn the work bowl cover to the left and remove.

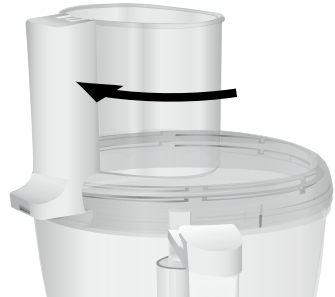

Disassembling the Food Processor

4. If using a disc, remove it before removing the bowl. Place two fingers under each side of the disc and lift it straight up. Remove the disc stem.

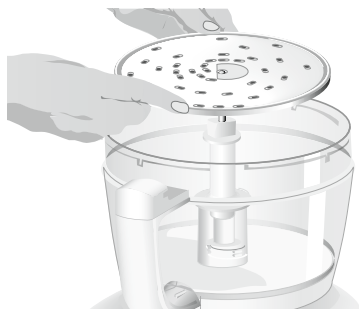

6. Turn the work bowl to the left to unlock it from the base. Lift to remove.



5. If using the mini bowl or chef's bowl, grasp and remove the bowl using the finger grips located along the top edge of the bowl.



7. The multipurpose blade can be removed from the work bowl before the contents are emptied. The blade can also be held in place as you remove food: grasp the work bowl from the bottom and place one finger through the center opening to grip the blade shaft. Then remove food from the bowl and blade with a spatula.



Care and Cleaning

WARNING

Cut Hazard

Handle blades carefully.

Failure to do so can result in cuts.

1. Press the "O" Button.
2. Unplug the Food Processor before cleaning.
3. Wipe the base and cord with a warm, sudsy cloth, and wipe clean with a damp cloth. Dry with a soft cloth. Do not use abrasive cleansers or scouring pads.
4. All the other parts of the Food Processor are dishwasher safe. Be sure to load them away from exposed heating elements in the dishwasher. If washing the Food Processor parts by hand, avoid the use of abrasive cleansers or scouring pads. They may scratch or cloud the work bowl and cover. Thoroughly dry all parts after washing.
5. To prevent damage to the interlock system, always store the work bowl and work bowl cover in the unlocked position when not in use.



6. Wrap the power cord around the work bowl. Secure the plug by clipping it to the cord.
7. Disassembled discs, shafts, and blades should be stored in the provided storage case, and in a location out of the reach of children.

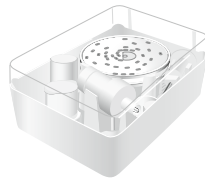

5KFPM771

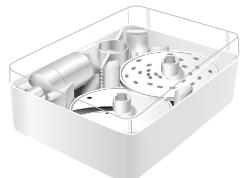

**5KFPM775 &
5KFPM776**

Troubleshooting

- **If your Food Processor should fail to operate, check the following:**

- Make sure the work bowl and work bowl cover are properly locked on the base, and the food pusher is inserted to the maximum fill line on the feed tube.
- See if the Food Processor is plugged into a proper electrical outlet (see “Electrical Requirements” on page 3). If it is, unplug the Food Processor, then plug it into the same outlet again.

⚠ WARNING



Electrical Shock Hazard

Plug into a grounded 3 prong outlet.

Do not remove ground prong.

Do not use an adapter.

Do not use an extension cord.

Failure to follow these instructions can result in death, fire or electrical shock.

If the Food Processor still does not work, check the fuse or circuit breaker on the electrical circuit the Food Processor is connected to and make sure the circuit is closed.

- **If your Food Processor should fail to slice or shred when using the disc:**

- Make sure the raised-blade side of the disc is positioned face up on the disc stem. The disc has a raised nub on the top and grooves underneath to help align it properly.

- **If your Food Processor lid won't close when using the disc:**

- Make sure the disc is installed correctly with the raised nub on top, and is positioned properly on the disc stem.

- **If the Food Processor shuts off while it is running:**

- The Food Processor may be overheated. If the motor exceeds a certain temperature, it will automatically shut off to prevent damage. This should be an extremely rare occurrence. If it happens, press the “O” Button and wait 15 minutes for the Food Processor to cool before resuming. If the Food Processor still refuses to run, wait an additional 15 minutes for the Food Processor to cool.

- **If you have difficulty removing the food pusher from the feed tube:**

- Food particles are probably lodged in the interlock system. To free the pusher, soak the work bowl cover in warm water or wash it in a dishwasher.

If the problem cannot be corrected with the steps in this section, see the KitchenAid warranty and after sales service section on pages 27-28. Do not return the Food Processor to the retailer – they do not provide service.

Food Processing Tips



USING THE MULTIPURPOSE BLADE

To chop fresh fruits or vegetables:

Peel, core, and/or remove seeds. Cut food in 2.54 to 3.81 cm pieces. Process food to desired size, using short pulses, 1 to 2 seconds each time. Scrape sides of bowl, if necessary.

To puree cooked fruits and vegetables (except potatoes):

Add 60 ml ($\frac{1}{4}$ cup) liquid from recipe per cup of food. Process food, using short pulses, until finely chopped. Then process continuously until reaching desired texture. Scrape sides of bowl, if necessary.

To prepare mashed potatoes:

Insert chef's bowl (5KFPM776) into the work bowl. Using the shredding disc, shred hot, cooked potatoes. Remove the chef's bowl with potatoes. Place multipurpose blade in work bowl, and add shredded potatoes, softened butter, milk, and seasonings. Pulse 3 to 4 times, 2 to 3 seconds each time, until milk is absorbed and texture is smooth. Do not overprocess. For food processor models other than the 5KFPM776, the work bowl may be used for the entire process.

To chop dried (or sticky) fruits:

The food should be cold. Add 30 g ($\frac{1}{4}$ cup) flour from recipe per 60 g ($\frac{1}{2}$ cup) dried fruit. Process fruit, using short pulses, until reaching desired texture.

To finely chop citrus peel:

With sharp knife, peel colored portion (without white membrane) from citrus. Cut peel in small strips. Process until finely chopped.

To mince garlic or to chop fresh herbs or small quantities of vegetables:

With processor running, add food through the small feed tube. Process until chopped. For best results, make sure work bowl and herbs are very dry before chopping.

To chop nuts or make nut butters:

Process up to 375 g (3 cups) of nuts to desired texture, using short pulses, 1 to 2 seconds each time. For a coarser texture, process smaller batches, pulsing 1 or 2 times, 1 to 2 seconds each time. Pulse more often for finer texture. For nut butters, process continuously until smooth. Store in refrigerator.

To chop cooked or raw meat, poultry or seafood:

The food should be very cold. Cut in 2.54 cm pieces. Process up to 450 g at a time to desired size, using short pulses, 1 to 2 seconds each time. Scrape sides of bowl, if necessary.

To make bread, cookie, or cracker crumbs:

Break food into 3.8 to 5 cm pieces. Process until fine. For larger pieces, pulse 2 to 3 times, 1 to 2 seconds each time. Then process until fine.

To melt chocolate in a recipe:

Combine chocolate and sugar from recipe in work bowl. Process until finely chopped. Heat liquid from recipe. With processor running, pour hot liquid through the small feed tube. Process until smooth.

Food Processing Tips

To grate hard cheeses, such as Parmesan and Pecorino:

Never attempt to process cheese that cannot be pierced with the tip of a sharp knife. You can use the multi-purpose blade to grate hard cheeses. Cut cheese in 2.54 cm pieces. Place in work bowl. Process, using short pulses, until coarsely chopped. Process continuously until finely grated. Pieces of cheese can also be added through the small feed tube while the processor is running.



USING A SLICING OR SHREDDING DISC

NOTE: When cutting and packing food items in the ultra wide mouth feed tube, do not exceed the maximum fill line. This will permit the pusher to engage the interlock and the unit to operate.

To cut julienne, or match stick, strips of vegetables and fruits:

Cut food to fit feed tube horizontally. Position food horizontally in feed tube. Process, using even pressure to make plank-like slices. Re-stack slices and position vertically or horizontally in feed tube. Process, using even pressure.

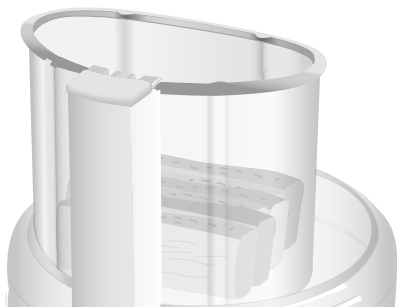

To slice or shred fruits or vegetables that are long and relatively small in diameter, such as celery, carrots, and bananas:

Cut food to fit feed tube vertically or horizontally, and pack feed tube securely to keep food positioned properly.

Process using even pressure. Or use the small feed tube in the two-piece food pusher. Position food vertically in the tube and use the small food pusher to process food.



To slice or shred fruits and vegetables that are round, such as onions, apples, and green peppers:

Peel, core, and/or remove seeds. Cut in halves or quarters to fit feed tube. Position in feed tube. Process, using even pressure.

To slice or shred fruits and vegetables that are small, such as strawberries, mushrooms, and radishes:

Position food vertically or horizontally in layers within the feed tube. Fill feed tube in order to keep food positioned properly, but do not exceed the maximum fill line. Process, using even pressure. Or use the small feed tube in the two-piece food pusher. Position food vertically in the tube and use the small food pusher to process food.

Food Processing Tips

To shred spinach and other leaves:

Stack leaves. Roll up and stand up in feed tube. Process, using even pressure



To slice uncooked meat or poultry, such as stir-fry meats:

Cut or roll food to fit feed tube. Wrap and freeze food until hard to the touch, 30 minutes to 2 hours, depending on thickness of food. Check to be sure you can still pierce food with the tip of a sharp knife. If not, allow to thaw slightly. Process, using even pressure.

To slice cooked meat or poultry, including salami, pepperoni, etc.:

Food should be very cold. Cut in pieces to fit feed tube. Process food using firm, even pressure.

To shred firm and soft cheeses:

Firm cheese should be very cold. For best results with soft cheeses, such as mozzarella, freeze 10 to 15 minutes before processing. Cut to fit feed tube. Process, using even pressure.

To slice or shred items that are "pear-shaped" like sweet potatoes, eggplant and squash:

Position food horizontally so that the bigger/fatter side is to the left of the feed tube when you are facing the unit. Process, using even pressure on the food pusher.



USING THE DOUGH BLADE

The dough blade is specially designed for mixing and kneading yeast dough quickly and thoroughly. One minute or less of operating time is all that is needed to form a dough ball. Processing longer than one minute will make the dough come apart and stick to the sides of the bowl. For the best results, do not knead recipes which use more than 250 to 375 g (2-3 cups) of flour.

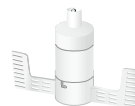

USING THE EGG WHIP

To make soft egg white meringue:

Place 3 egg whites and $\frac{1}{4}$ teaspoon cream of tartar in work bowl fitted with egg whip. Process until foamy, about 30 to 45 seconds. With processor running, slowly add 40 g ($\frac{1}{2}$ cup) sugar through the small feed tube. Process until stiff peaks form, about $2\frac{1}{2}$ to 3 minutes. Stop processor as necessary to check texture of mixture.

To whip cream:

Place heavy cream in work bowl fitted with egg whip. Process 30 seconds. With processor running, add 2 tablespoons powdered sugar through the small feed tube. Process just until soft peaks form, about 30 to 40 seconds. Stop processor as necessary to check texture of mixture. With processor running, add $\frac{1}{2}$ teaspoon vanilla, if desired, through the small feed tube. Process just until mixed. Do not overprocess.

Helpful Hints

1. To avoid damage to the blade or motor, do not process food that is so hard or firmly frozen that it cannot be pierced with the tip of a sharp knife. If a piece of hard food, such as a carrot, becomes wedged or stuck on the blade, stop the processor and remove the blade. Gently remove food from the blade.
2. When cutting and packing food items in the ultra wide mouth feed tube, do not exceed the maximum fill line. This will permit the pusher to engage the interlock and the unit to operate.
3. Do not overfill work bowl or mini bowl. For thin mixtures, fill work bowl up to $\frac{1}{2}$ to $\frac{2}{3}$ full. For thicker mixtures, fill work bowl up to $\frac{3}{4}$ full. For liquids, fill up to the maximum level as described on page 12. When chopping, the work bowl should be no more than $\frac{1}{2}$ to $\frac{1}{2}$ full. Use the mini bowl for up to 237 ml (1 cup) of liquid or 63 g ($\frac{1}{2}$ cup) solids.
4. Position slicing discs so the cutting surface is just to the right of the feed tube. This allows the blade a full rotation before contacting the food.
5. To capitalize on the speed of the processor, drop ingredients to be chopped through the small feed tube while the processor is running.
6. Different foods require varying degrees of pressure for best shredding and slicing results. In general, use light pressure for soft, delicate foods (strawberries, tomatoes, etc.), moderate pressure for medium foods (zucchini, potatoes, etc.), and firmer pressure for harder foods (carrots, apples, hard cheeses, partially frozen meats, etc.).
7. Soft and medium-hard cheese may spread out or roll up on the shredding disc. To avoid this, shred only well-chilled cheese.
8. Sometimes slender foods, such as carrots or celery, fall over in the feed tube, resulting in an uneven slice. To minimize this, cut food in several pieces and pack the feed tube with the food. For processing small or slender items, the small feed tube in the two-piece food pusher will prove especially convenient.
9. When preparing a cake or cookie batter or quick bread, use the multipurpose blade to cream fat and sugar first. Add dry ingredients last. Place nuts and fruit on top of flour mixture to prevent overchopping. Process nuts and fruits, using short pulses, until blended with other ingredients. Do not overprocess.
10. When shredded or sliced food piles up on one side of the bowl, stop the processor and redistribute the food using a spatula.
11. When food quantity reaches the bottom of a slicing or shredding disc, remove the food.
12. A few larger pieces of food may remain on top of the disc after slicing or shredding. If desired, cut these by hand and add to mixture.
13. Organize processing tasks to minimize bowl cleanup. Process dry or firm ingredients before liquid ingredients.
14. To clean ingredients from the multi-purpose blade easily, just empty the work bowl, replace the lid, and pulse 1 to 2 seconds to spin the blade clean.



Helpful Hints

15. After removing the work bowl cover, place it upside down on the counter. This will help keep the counter clean.
16. To remove the contents of the work bowl without removing the multi-purpose blade, grasp the work bowl from the bottom and place one finger through the center opening to hold the blade in place. Then remove food from the bowl and blade with a spatula.
17. Your Food Processor is not designed to perform the following functions:
 - grind coffee beans, grains, or hard spices
 - grind bones or other inedible parts of food
 - liquefy raw fruits or vegetables
 - slice hard-cooked eggs or unchilled meats.
18. If any plastic parts should discolor due to the types of food processed, clean them with lemon juice.

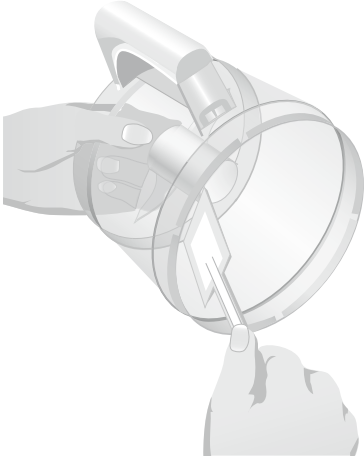

White Balsamic Vinaigrette

- 1 *tablespoon fresh basil leaves*
- 1 *tablespoon fresh oregano leaves*
- 1 *clove garlic*
- 3 *tablespoons white balsamic vinegar**
- 3 *tablespoons white wine vinegar**
- $\frac{1}{2}$ *teaspoon salt*
- $\frac{1}{4}$ *teaspoon dry mustard*
- $\frac{1}{8}$ *teaspoon ground red pepper*
- 180 *ml ($\frac{3}{4}$ cup) extra virgin olive oil*

Position mini bowl and mini blade in work bowl. With processor running, add basil, oregano, and garlic through the small feed tube. Process until chopped, 5 to 8 seconds. Scrape sides of bowl. With processor running, add balsamic vinegar, wine vinegar, salt, mustard, and red pepper. Process until mixed, about 5 seconds. With processor running, slowly drizzle oil through the small feed tube. Process until smooth and thick. Serve with green salads.

Yield: 8 servings (2 tablespoons per serving).

*Three tablespoons each of dark balsamic vinegar and red wine vinegar may be substituted.

Per Serving: about 190 cal.

Cheddar Broccoli Soup

- 230 g sharp Cheddar cheese, chilled
- 1 small onion, cut into halves lengthwise
- 1 rib celery, cut into 6 cm pieces
- 2 tablespoons butter or margarine
- 1 large head (about 450 g) broccoli
- 700 ml (3 cups) chicken broth
- 475 ml (2 cups) milk, divided
- 30 g (¼ cups) all-purpose flour
- 2 teaspoons Dijon mustard
- 1 teaspoon curry powder, if desired
- ⅓ teaspoon hot pepper sauce
- Position 4 mm shredding disc in work bowl. Add cheese. Process to shred. Remove and set aside.
- Exchange shredding disc for 2 mm slicing disc in work bowl. Add onion and celery. Process to slice. Melt butter in large saucepan or Dutch oven over medium heat. Remove onion and celery to saucepan. Cook 2 to 3 minutes, or until crisp-tender, stirring occasionally.
- Cut stems from broccoli, and peel tough coating from stems. Cut florets into small pieces. Position 2 mm slicing disc in work bowl. Add broccoli stems. Process to slice. Remove to saucepan.
- Add broccoli florets and broth to saucepan. Bring to a boil over medium-high heat. Reduce heat; partially cover and simmer 6 to 10 minutes, or until broccoli is crisp-tender, stirring occasionally. Remove from heat.
- Exchange slicing disc for multipurpose blade in work bowl. With slotted spoon, remove vegetables from saucepan to work bowl. Add 178 ml (¾ cup) milk. Process until chopped, 5 to 8 seconds. Set aside.
- In medium mixing bowl, whisk flour into remaining 300 ml (1¼ cups) milk, whisking until smooth. Add mustard, curry powder, if desired, and pepper sauce. Stir until combined.
- Add milk mixture to broth in saucepan. Cook and stir over medium-high heat until bubbly and slightly thickened. Reduce heat to low. Add all but 30 g (¼ cup) shredded cheese; stir until melted.
- Add broccoli mixture to saucepan. Heat thoroughly. Garnish with remaining 30 g (¼ cup) cheese.
- Yield: 7 servings (237 ml/1 cup per serving).
- Per Serving: About 250 cal.

Spring Mix Basmati Rice

- 1 clove garlic
- 1 medium shallot, cut into quarters
- 1 tablespoon olive oil
- $\frac{1}{4}$ pound (about 125 g) fresh green beans, trimmed
- 1 small carrot, peeled and cut into halves crosswise
- 356 ml ($1\frac{1}{2}$ cups) chicken broth
- 237 ml (1 cup) water
- 1 teaspoon salt
- $\frac{1}{4}$ teaspoon black pepper
- 1 teaspoon ground coriander, if desired
- 170 g ($\frac{1}{2}$ cups) rice
- 227 g ($\frac{1}{2}$ pound) fresh asparagus
- 2 teaspoons fresh thyme leaves
- 2 tablespoons loosely packed fresh parsley leaves
- $\frac{1}{4}$ small red bell pepper, cut into quarters

Position multipurpose blade in work bowl. With processor running, add garlic through the small feed tube. Process 5 seconds. Add shallot. Pulse 2 to 3 times, about 2 seconds each time, or until chopped. In large saucepan over medium heat, heat oil. Add shallot mixture. Cook until tender, 1 to 2 minutes, stirring often. Remove from heat; set aside.

Exchange multipurpose blade for 2 mm slicing disc in work bowl. Add green beans and carrot. Process to slice. Remove to saucepan with shallot mixture. Add broth, water, salt, black pepper, and coriander, if desired. Bring to a boil. Stir in rice. Return to boil; reduce heat. Cover, simmer about 15 minutes, or until liquid is absorbed.

Meanwhile, cut tips from asparagus and reserve stalks; set aside. Exchange slicing disc for multipurpose blade in work bowl. With processor running, add thyme and parsley through the small feed tube. Process until chopped, about 3 seconds. Add bell pepper. Pulse 2 to 3 times, 1 to 2 seconds each time, or until coarsely chopped. Exchange multipurpose blade for 2 mm slicing disc in work bowl. Add asparagus stalks. Process to slice. Remove to saucepan with rice mixture. Add asparagus tips; stir well.

Cover; let stand 10 minutes. Fluff with a fork.

Yield: 6 servings (125 g/1 cup per serving).

Per Serving: About 200 cal.

Chicken Satay with Peanut Sauce

Chicken

- 2 *cloves garlic*
- 1 *teaspoon coarsely chopped gingerroot*
- 60 *ml (¼ cups) soy sauce*
- 2 *tablespoons peanut or vegetable oil*
- 2 *teaspoons brown sugar*
- 455 - 570 *g (1-1¼ pounds) chicken breast tenders*

Position multipurpose blade in work bowl. With processor running, add garlic and gingerroot through the small feed tube. Process until chopped, 5 to 10 seconds. Add soy sauce, oil, and brown sugar. Process until blended and sugar dissolves, 15 to 20 seconds. Remove to plastic resealable food storage bag or shallow pan.

Add chicken; coat with marinade. Marinate ½ hour at room temperature or at least 2 hours in refrigerator. Remove chicken from marinade, reserving marinade.

Thread chicken tenders on soaked wooden or oiled metal skewers. Grill over medium-hot coals or broil on oiled broiler pan 10 to 15 cm from heat for 8 to 10 minutes, or until thoroughly cooked, turning once. Brush with any remaining marinade once during cooking, if desired. Serve with warm or room temperature Peanut Sauce.

Sauce

- 80 *ml (⅓ cup) coconut milk*
- 30 *g (¼ cup) peanut butter*
- 2 *tablespoons soy sauce*
- ½ *teaspoon red curry paste*

Position multipurpose blade in work bowl. Add all ingredients. Process until blended, 5 to 10 seconds.

Yield: 4 servings.

Per Serving: About 290 cal.

Fresh Fruit Tart

Crust

125 g (1 cup) all-purpose flour

2 teaspoons sugar

¼ teaspoon salt

30 g (¼ cup) cold butter, cut into 2.5 cm pieces

1 tablespoon cold shortening

1 egg yolk

2 tablespoons ice water

1 teaspoon lemon juice

1 egg, blended with 1 tablespoon water

Position multipurpose blade in work bowl. Add flour, sugar, and salt. Process until mixed, about 2 seconds. Add butter and shortening. Pulse 3 to 4 times, 2 to 3 seconds each time, or until crumbly. In small bowl, blend 1 egg yolk, 2 tablespoons water, and lemon juice. Sprinkle evenly over flour mixture. Pulse 2 to 4 times, 2 to 3 seconds each time, or until mixture pulls away from sides of bowl and clings together. Remove dough, cover, and chill ½ hour.

Meanwhile, in small saucepan over medium heat, combine sugar, cornstarch, and salt. Add half-and-half and 2 egg yolks. Cook and stir until very thick. Remove from heat. Add vanilla. Whisk until smooth. Cool completely.

Place dough on floured surface. Roll into a circle 5 cm larger than inverted 25 cm tart pan. Fit into tart pan, being careful not to stretch dough. Trim edges of crust. Prick shell thoroughly with fork. Bake at 200°C for 8 to 12 minutes, or until light golden brown. Brush with egg and water mixture to seal holes. Bake for 1 minute longer to set egg. Cool completely.

Filling

30 g (¼ cup) sugar

1 tablespoon cornstarch

⅛ teaspoon salt

180 ml (¾ cup) half-and-half

2 egg yolks, beaten

½ teaspoon vanilla

Wash processor. Position 2 mm slicing disc in work bowl. Add peach. Process to slice. Remove and set aside. Position 2 mm slicing disc in work bowl. Add strawberries. Process to slice.

Spread custard mixture in crust. Arrange sliced fruit on custard. Carefully brush with melted jelly to cover fruit completely. Refrigerate at least 1 hour before serving.

Yield: 8 servings.

Topping

1 medium peach, peeled, cut into halves, and pit removed

125 g (1 cup) fresh strawberries, hulled

2 tablespoons apple jelly, melted

Tip: Tart is best served the same day it is made.

Per Serving: About 230 cal.

Household KitchenAid™ Food Processor Warranty

Length of Warranty:	KitchenAid Will Pay For:	KitchenAid Will Not Pay For:
<p>Europe, Australia and New Zealand: Three years Full Warranty from date of purchase on the Food Processor. Ten years Full Warranty from date of purchase on the motor.</p> <p>Other: One Year Full Warranty from date of purchase.</p>	<p>Replacement parts and repair labor costs to correct defects in materials or workmanship. Service must be provided by an Authorized KitchenAid Service Center.</p>	<p>A. Repairs when Food Processor is used for operations other than normal household food preparation.</p> <p>B. Damage resulting from accident, alterations, misuse, abuse, or installation/ operation not in accordance with local electrical codes.</p>

KITCHENAID DOES NOT ASSUME ANY RESPONSIBILITY FOR INDIRECT DAMAGES.

Service Centers

All service should be handled locally by an Authorized KitchenAid Service Center. Contact the dealer from whom the unit was purchased to obtain the name of the nearest Authorized KitchenAid Service Center.

In the U.K.:

Call: 0845 6011 287

In Ireland:

M.X. ELECTRIC
Service Department
25 Alymer Crescent
Kilcock, CO.KILDARE

Call: 1 679 2398/87 2581574

Fax: 1 628 4368

In Australia:

Call: 1800 990 990

In New Zealand:

Call: 0800 881 200

Customer Service

For U.K. & Northern Ireland:

Freephone helpline number on:
0800 988 1266
(calls from mobiles are charged
at your standard network rate)

For Southern Ireland:

Helpline number on:
+44 (0) 20 8616 5148

Address:

KitchenAid Europa, Inc.
PO BOX 19
B-2018 ANTWERP 11
BELGIUM

www.KitchenAid.co.uk

www.KitchenAid.com



FOR THE WAY IT'S MADE.™

® Registered Trademark/™ Trademark of KitchenAid, U.S.A.
© 2009. All rights reserved.

Specifications subject to change without notice.

Free Manuals Download Website

<http://myh66.com>

<http://usermanuals.us>

<http://www.somanuals.com>

<http://www.4manuals.cc>

<http://www.manual-lib.com>

<http://www.404manual.com>

<http://www.luxmanual.com>

<http://aubethermostatmanual.com>

Golf course search by state

<http://golfingnear.com>

Email search by domain

<http://emailbydomain.com>

Auto manuals search

<http://auto.somanuals.com>

TV manuals search

<http://tv.somanuals.com>