

Installation Instructions

27" and 30" Electric Warming Oven

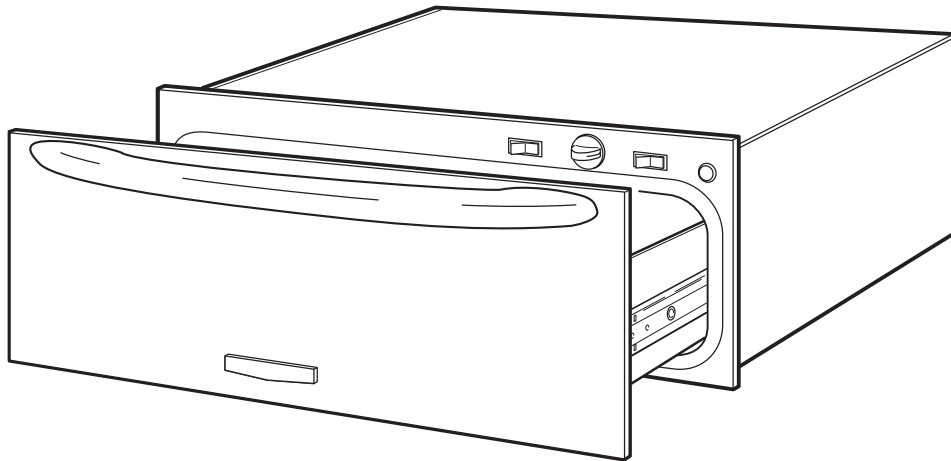

Questions regarding features, operation, performance, parts or service? Call 1-800-422-1230 or visit our web site at www.kitchenaid.com.

Call when you:

- Have questions about warming oven installation or operation.
- Need to obtain the name and number of an authorized service company.

When you call, you will need:

- The warming oven model number.
- The warming oven serial number.

Both numbers are listed on the model/serial rating plate, located on the upper left front corner of the oven cavity.

KitchenAid[®]
FOR THE WAY IT'S MADE[®]

IMPORTANT: Read and save these instructions.

IMPORTANT:

Installer: Leave Installation Instructions with the homeowner.

Homeowner: Keep Installation Instructions for future reference. Save Installation Instructions for local electrical inspector's use.

Write down the model and serial numbers before installing warming oven.

Both numbers are on the model/serial rating plate, located on the upper left front corner of the oven cavity.

Model # _____

Serial # _____

Part No. 4452828

Before you start...

Your safety and the safety of others is very important.

We have provided many important safety messages in this manual and on your appliance. Always read and obey all safety messages.



This is the safety alert symbol. This symbol alerts you to hazards that can kill or hurt you and others. All safety messages will be preceded by the safety alert symbol and the word "DANGER" or "WARNING". These words mean:

! DANGER

You will be killed or seriously injured if you don't follow instructions.

! WARNING

You can be killed or seriously injured if you don't follow instructions.

All safety messages will identify the hazard, tell you how to reduce the chance of injury, and tell you what can happen if the instructions are not followed.

Important: Observe all governing codes and ordinances.

Proper installation is your responsibility. Have a qualified technician install this oven.

Oven location should be away from strong draft areas, such as windows, doors and strong heating vents.

Cabinet opening dimensions that are shown must be used. Given dimensions provide minimum clearance.

Recessed installation area must provide complete enclosure around the recessed portion of the oven.

Electrical ground is required. See "Electrical requirements."

Electrical supply outlet should be located in the rear wall on the lower right side of the cutout or in an adjacent cabinet. The outlet must be recessed. If the electrical outlet is located in an adjacent cabinet, provide a 1-3/8" dia. minimum power supply cord plug clearance hole in the back of the cutout or support surface.

Oven support surface MUST be solid, level and flush with bottom of cabinet cutout.

There is no provision to level the oven after it has been installed. If the installation is not level, the door may slide open or not seal tightly allowing heat to escape resulting in poor oven performance.

It is the customer's responsibility:

To contact a qualified electrical installer.

To assure that the electrical installation is adequate and in conformance with National Electrical Code, ANSI/NFPA 70 — latest edition*, and all local codes and ordinances.

Copies of the standards listed may be obtained from:

* National Fire Protection Association
One Batterymarch Park
Quincy, Massachusetts 02269

Tools needed for installation:



Parts supplied:

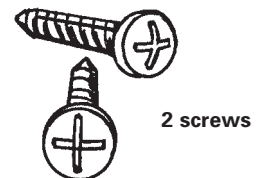

Product Dimensions

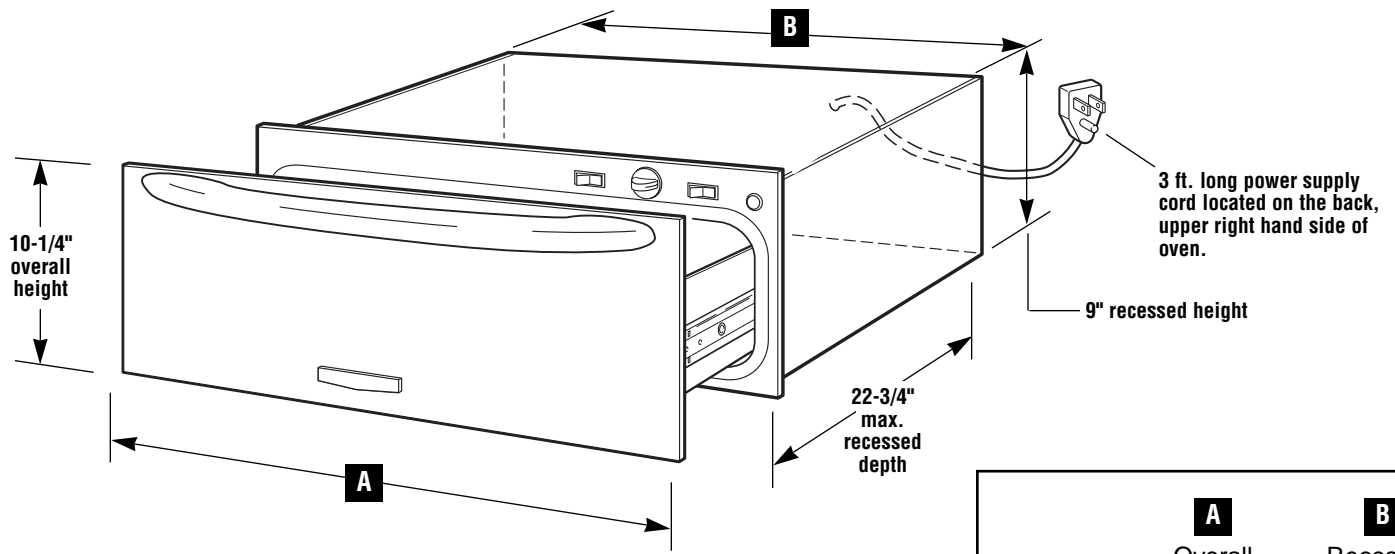

Oven Size	A Overall Width	B Recessed Width
27"	26-3/4"	25-1/4"
30"	29-3/4"	28-1/4"

Cutout Dimensions

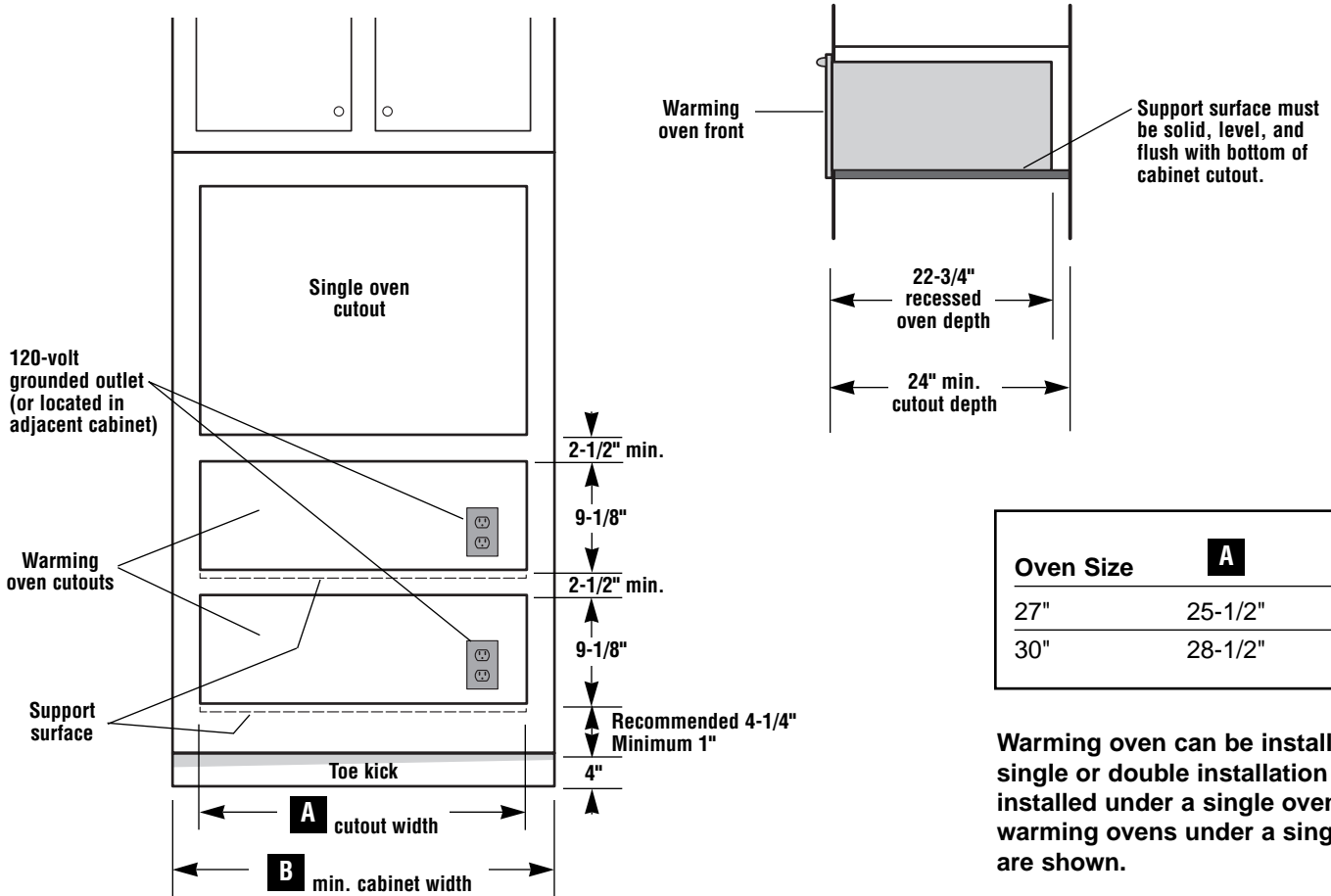

Oven Size	A	B
27"	25-1/2"	27"
30"	28-1/2"	30"

Warming oven can be installed as a single or double installation or installed under a single oven. Two warming ovens under a single oven are shown.

Electrical requirements

⚠ WARNING



Electrical Shock Hazard
Plug into a grounded 3-prong outlet.
Do not remove ground prong.
Do not use an adapter.
Do not use an extension cord.
Failure to follow these instructions can result in death, fire, or electrical shock.

Important: Observe all governing codes and ordinances.

It is the customer's responsibility:

To contact a qualified electrical installer.

To assure that the electrical installation is adequate and in conformance with National Electrical Code, ANSI/NFPA 70 — latest edition*, and all local codes and ordinances.

You must have:

- 120-volt, 60Hz, AC-only, 15- or 20-amp., fused electrical supply.
- outlet located in the cabinet as close as possible to the warming oven.

We recommend:

- a time-delay fuse or circuit breaker.
- a separate circuit serving this appliance only.

If codes permit and a separate ground wire is used, it is recommended that a qualified electrician determine that the ground path is adequate.

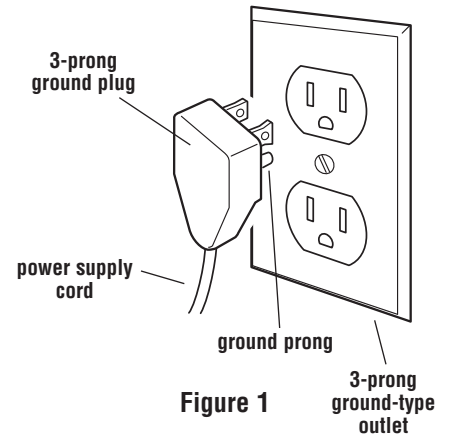

Figure 1

For your personal safety, this appliance must be grounded. This appliance is equipped with a power supply cord having 3-prong ground plug. To minimize possible shock hazard, the cord must be plugged into a mating 3-prong ground-type outlet, grounded in accordance with local codes and ordinances. See Figure 1. If a mating outlet is not available, it is the personal responsibility and obligation of the customer to have a properly grounded 3-prong outlet installed by a qualified electrician.

Warning — Improper connection of the equipment-grounding conductor can result in a risk of electric shock. Check with a qualified electrician or serviceman if you are in doubt as to whether the appliance is properly grounded. Do not modify the plug provided with the appliance - if it will not fit the outlet, have a proper outlet installed by a qualified electrician.

Installation

⚠ WARNING

Excessive Weight Hazard

Use two or more people to move and install oven.

Failure to follow this instruction can result in back or other injury.

Important: Use both hands to remove oven drawer.

Do Not use handle or drawer slides for lifting.

1. Turn power supply off. Move oven close to final position.

- Remove and discard shipping materials, tape and protective film from the oven.
- Remove and set aside racks and other parts from inside oven.

2. Remove the drawer:

- Pull drawer to its full open position.

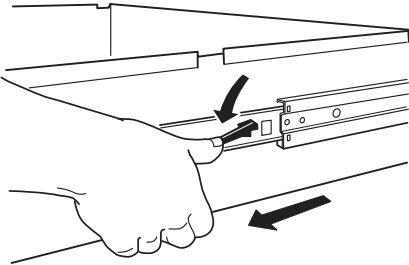

- Press tab down on right and lift tab upward on left, then slide drawer out about 1 inch.
- Carefully remove the drawer from the slides holding on to the sides, not the drawer front.
- Set drawer aside on protected surface.

3. Carefully support the oven in front of the cutout. Make sure the power to the outlet is turned off and that the warming oven power switch is set to the "OFF" position.

- Plug the power supply cord into the grounded outlet.
- Slide the oven into the cutout.
- Carefully push against the seal area of the oven front frame and slide the oven completely into the cabinet until the front frame is positioned flush against the cabinet face.

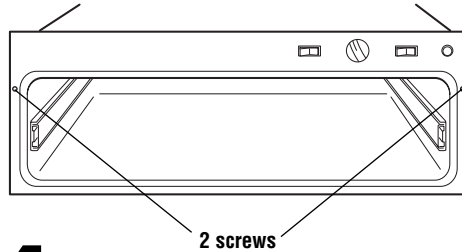

4. Use two (2) screws provided to secure the warming oven frame to the cabinet.

5. Replace the drawer:

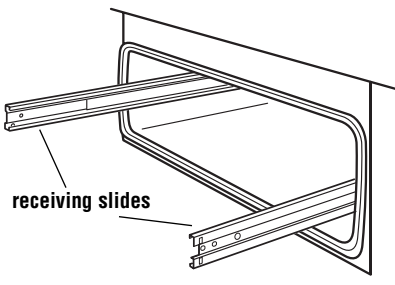

- Align the drawer guides with the receiving slides.
- Push drawer in completely. Gently open and close drawer to ensure it is seated properly on the slides.

6. Refer to the "Use and Care Guide," turn the oven on and check the oven's operation.

If warming oven does not operate:

- Check that the circuit breaker is not tripped or the house fuse blown.
- Check that the power supply cord is plugged into the outlet.

If you need assistance:

The KitchenAid Consumer Assistance Center will answer any questions about operating or maintaining your warming oven not covered in the Installation Instructions. The KitchenAid Consumer Assistance Center is open 24 hours a day, 7 days a week. Just dial 1-800-422-1230 — the call is free within the continental United States, or visit our web site at www.kitchenaid.com.

When you call, you will need the warming oven model number and serial number. Both numbers can be found on the model/serial rating plate located on the upper left front corner of the oven cavity.

If you need service:

In the event that your KitchenAid appliance should need service, call the dealer from whom you purchased the appliance or a KitchenAid-designated service company. A KitchenAid-designated service company is listed in the Yellow Pages of your telephone directory under "Appliances — Household — Major — Service and Repair."

You can also obtain the service company's name and number by dialing, free within the continental United States, the KitchenAid Consumer Assistance Center telephone number, 1-800-422-1230. A special operator will tell you the name of your nearest KitchenAid-designated service company.

Maintain the quality built into your KitchenAid appliance — call a KitchenAid-designated service company.

Free Manuals Download Website

<http://myh66.com>

<http://usermanuals.us>

<http://www.somanuals.com>

<http://www.4manuals.cc>

<http://www.manual-lib.com>

<http://www.404manual.com>

<http://www.luxmanual.com>

<http://aubethermostatmanual.com>

Golf course search by state

<http://golfingnear.com>

Email search by domain

<http://emailbydomain.com>

Auto manuals search

<http://auto.somanuals.com>

TV manuals search

<http://tv.somanuals.com>