

# KitchenAid®

## HOME APPLIANCES

# Installation Instructions

Part No. 3184435 Rev. A

### 27" Electric Built-in Combination

- Microwave and Thermal Oven
- Microwave and Thermal Convection Oven
- Microwave Convection and Thermal Convection Oven

**IMPORTANT:**  
**Read and save**  
**these instructions.**

**IMPORTANT:**

**Installer:** Leave Installation Instructions with the homeowner.

**Homeowner:** Keep Installation Instructions for future reference.

**Save** Installation Instructions for local electrical inspector's use.

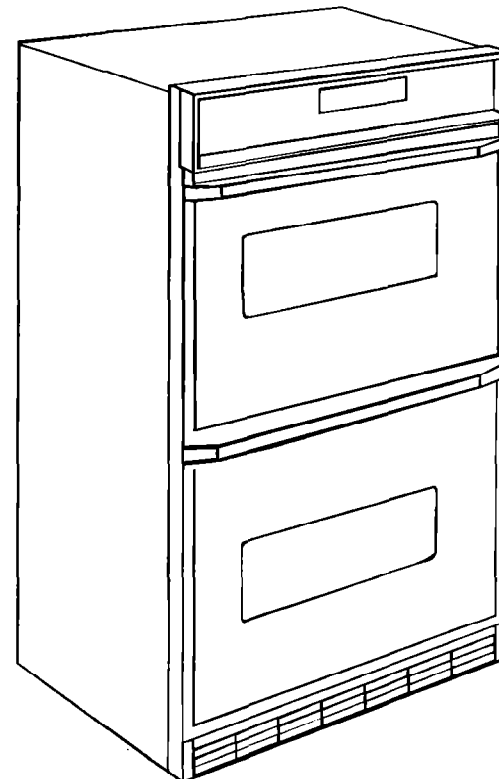

10/94

## 27" Thermal and Thermal Convection Double ovens

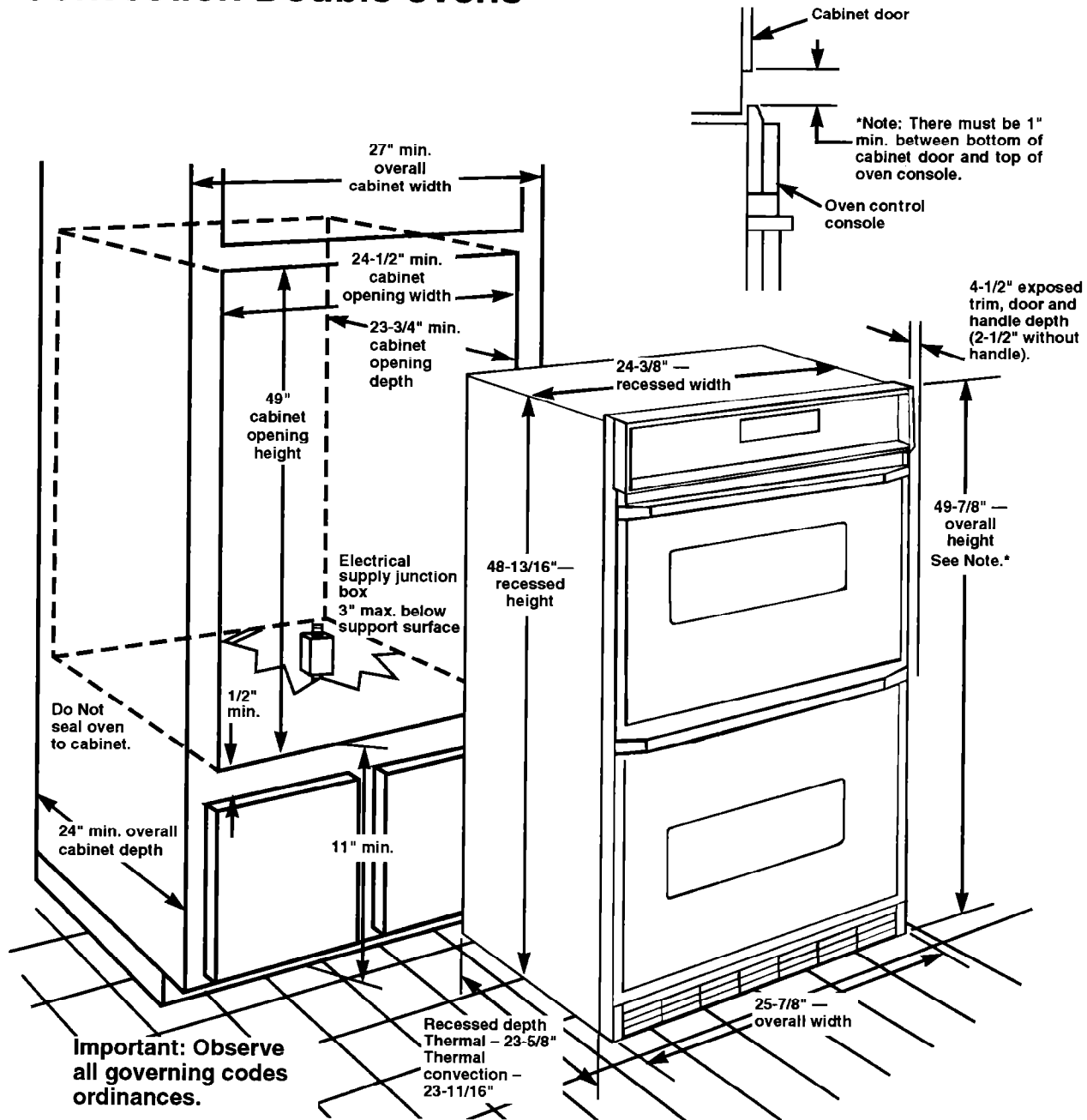

## Before you start...

### Read the electrical and carpentry instructions.

Proper installation is your responsibility. A qualified technician should install this oven. Make sure you have everything necessary for correct installation. It is the responsibility of the installer to comply with the installation clearances specified on the serial/rating plate. The serial/rating plate can be found behind the oven door on the front frame of the oven.

**Check location** where the built-in oven will be installed. The location should be away from strong draft areas, such as windows, doors, and strong heating vents. The built-in oven should be located for convenient use in the kitchen.

**Remove all packaging material** from microwave oven cavity. Check microwave oven area for damage — see WARNING below. If any damage is evident, do not operate until microwave oven is checked by an authorized service technician.

**Cabinet opening dimensions** that are shown must be used. Given dimensions provide minimum clearance. Contact surface must be solid and level and flush with the bottom.

**The recessed installation area** must provide complete enclosure around the recessed portion of the oven.

**ALL OPENINGS IN THE WALL OR FLOOR WHERE THE BUILT-IN OVEN IS TO BE INSTALLED MUST BE SEALED.**

**Electrical ground** is required. See "Electrical requirements."

### NOTE:

The oven support surface must be flush with the bottom of the cabinet cutout.

### CAUTION

#### Cabinet Damage

Do Not block the oven vent. Blocking the oven vent may cause cabinet damage and poor baking performance.

### WARNING

#### Excessive Microwave Energy Exposure

- Do Not attempt to operate the microwave oven with the door open.
- Do Not tamper with or defeat the safety interlocks.
- Do Not place objects between the microwave oven front face and door.
- Do Not allow soil or cleaner residue to accumulate on sealing surface of the microwave oven door.
- Do Not operate the microwave oven if damaged.
- Do Not operate the microwave oven if:
  - door is bent.
  - hinges and latches are broken or loose.
  - door seals, sealing surfaces or glass are broken.

The microwave oven door must close properly to provide safe operation.

- Only have a qualified repair person adjust, repair and check microwave oven for microwave leakage after a repair is made.
- Do Not use microwave for commercial purposes. The microwave oven in this unit is designed for household use only.

Failure to follow these instructions could result in exposure to excessive microwave energy.

### WARNING

#### Electrical Shock Hazard

It is the customer's responsibility:

- To contact a qualified electrical installer.
- To assure that the electrical installation is adequate and in conformance with National Electrical Code, ANSI/NFPA 70 — latest edition\*\*, and all local codes and ordinances.

Failure to do so could result in fire, electrical shock or other personal injury.

#### Personal Injury Hazard

Securely fasten oven to cabinet using the screws provided.

Failure to do so could cause the oven to move or tip during use and result in personal injury.

## Tools needed for installation:

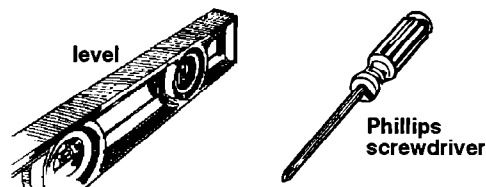

## Parts supplied for installation:

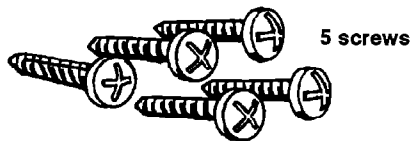

## Electrical requirements

### WARNING

#### Electrical Shock Hazard

- Electrical ground is required on this appliance.
- Do Not ground to a gas pipe.
- Do Not have a fuse in the neutral or grounding circuit. A fuse in the neutral or grounding circuit could result in an electrical shock.
- Check with a qualified electrician if you are in doubt as to whether the appliance is properly grounded.

Failure to follow these instructions could result in serious injury or death.

If codes permit and a separate grounding wire is used, it is recommended that a qualified electrician determine that the grounding path is adequate.

### IMPORTANT:

Save Installation Instructions for the local electrical inspector's use.

**A.** This appliance must be connected to the proper electrical voltage and frequency as specified on the serial/rating plate located behind the oven door on the front frame. Models rated at 7.0 kw on 240 volts (5.3 kw on 208 volts) or more require a separate 40-ampere circuit. Models rated at 3.6 kw on 240 volts (2.7 kw on 208 volts) or less require a separate 30-ampere circuit. Fuse both sides of the line. A time-delay fuse or circuit breaker is recommended.

**B.** OVEN MUST BE CONNECTED WITH COPPER WIRE ONLY.

**C.** Wire sizes and connections must conform to the requirements of the National Electrical Code, ANSI/NFPA 70 — latest edition\*\*, and all local codes and ordinances. Wires sizes and connections must conform with the rating of the appliance. Copies of the standards listed may be obtained from:

\*\*National Fire Protection Association  
Batterymarch Park  
Quincy, Massachusetts 02269

**D.** This appliance should be connected directly to the fused disconnect (or circuit breaker box) through flexible, armored or non-metallic sheathed, copper cable (with grounding wire). The flexible armored cable from the appliance should be connected directly to the junction box.

**E.** Locate the junction box to allow as much slack in the cable as possible between the junction box and the appliance so that the oven can be moved if servicing is ever necessary. **Do Not cut the conduit.**

**F.** A U.L.-listed conduit connector **must** be provided at the junction box.

**G.** A wiring diagram is included in the Tech Sheet. The Tech Sheet is located behind the oven control panel.

## Electrical connection

### ⚠ WARNING

#### Electrical Shock Hazard

- Electrical ground is required on this appliance.
- Do Not connect to the electrical supply until appliance is permanently grounded.
- Disconnect power to the junction box before making the electrical connection.
- This appliance must be connected to a grounded, metallic, permanent wiring system, or a grounding connector should be connected to the grounding terminal or wire lead on the appliance. Failure to do so could result in a fire, personal injury or electrical shock.

This appliance is manufactured with white (neutral) power supply wire and a cabinet-connected green grounding wire twisted together.

Connect the appliance cable to the junction box through the U.L.-listed conduit connector. Complete electrical connection according to local codes and ordinances.

**A. Where local codes permit...**  
Connecting the cabinet-grounding conductor to the neutral (white) junction box wire:

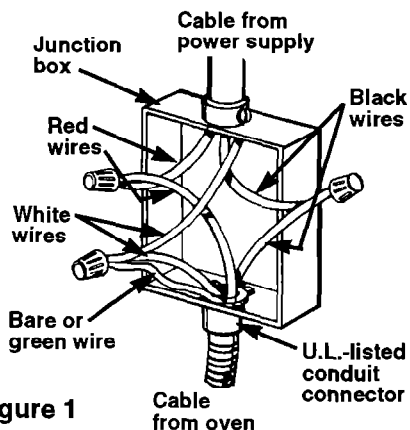

Figure 1

#### Grounded Neutral

1. Disconnect the power supply.
2. Remove the terminal block cover.
3. Connect together 3 wires: green and white appliance cable wires and the neutral (white) wire in junction box.
4. Connect the two black wires together; then the two red wires together. See Figure 1.

**B. Where local codes Do Not permit...**

Connecting the cabinet-grounding conductor to the neutral (white) junction box wire:

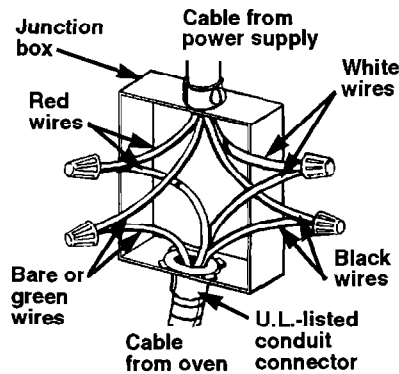

Figure 2

#### Ungrounded Neutral

1. Disconnect power supply.
2. Separate the green and white appliance cable wires.
3. Connect the white appliance cable wire to the neutral (white) wire in the junction box.
4. Connect the two black wires together; then the two red wires together. See Figure 2.
5. Connect the green or bare grounding wire from the appliance cable to a grounded wire in the junction box.

**C. If connecting to a four-wire electrical system...**

Do Not connect the cabinet-grounding conductor to the neutral (white) junction box wire.

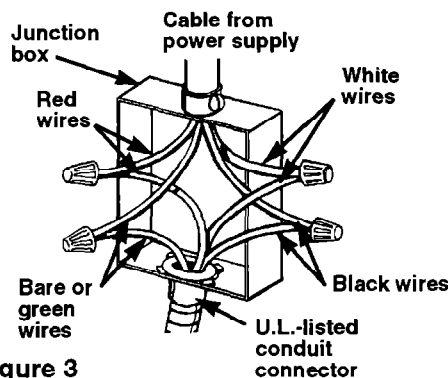

Figure 3

1. Disconnect the power supply.
2. Separate the green (or bare) and white appliance cable wires.
3. Connect the white appliance cable wire to the neutral (white) wire in the junction box.
4. Connect the two black wires together; then the two red wires together. See Figure 3.
5. Connect the green appliance cable wire to the green grounding wire in the junction box.

## Now start...

With oven in kitchen.

**1.** Remove shipping materials, tape, and protective film from microwave oven. **Do Not remove shipping base at this time.**

**2.** Remove the racks and other parts from inside the oven. Remove the air grille taped to the top or side of oven.

### ⚠ WARNING

#### Personal Injury/Product Damage Hazard

- Use both hands to remove oven door.
- Grasp only the sides of oven door.
- Do Not use handle or any portion of the front frame or trim for lifting.
- Because of the weight and size of the oven, two or more people are needed to move and safely install the oven. Failure to properly grasp the oven door or to lift oven properly could result in damage to the product or personal injury.

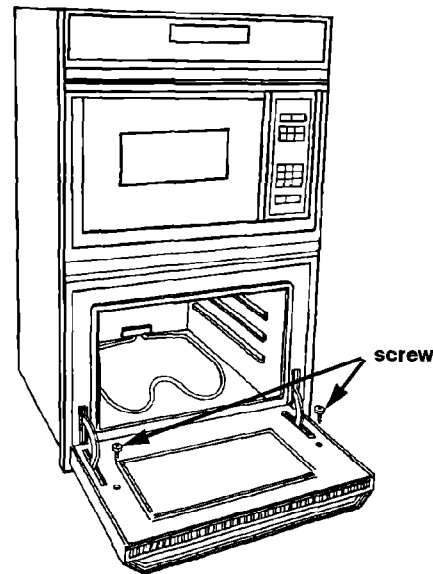

**3.** Completely open the oven door. Remove the two oven door screws. (Not all models have oven door screws.)

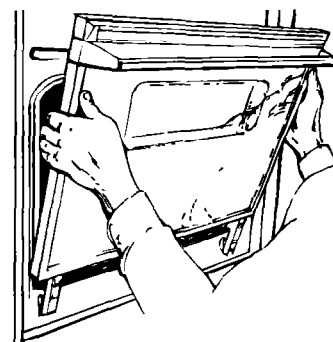

**4.**

Close oven door to the broil position. Grasp the sides of the oven door and pull the door up and out of the hinge slots to remove. Set door aside.

### ⚠ CAUTION

#### Floor Damage

Before moving oven across floor, check that oven is on shipping base or slide oven onto cardboard or hardboard. Failure to follow these instructions may result in damage to floor covering.

**5.** Turn power supply off. Move oven close to final position. Remove and discard shipping base, cardboard or hardboard. Feed appliance cable through the opening in cabinet. Make electrical connection. See "Electrical requirements" and "Electrical connection" sections, Panels A and B.

### ⚠ CAUTION

#### Product Damage

Carefully push against the seal area of the oven front frame when pushing the oven into the cabinet. Do Not push against outside edges. Failure to follow these instructions can result in damage to oven finish.

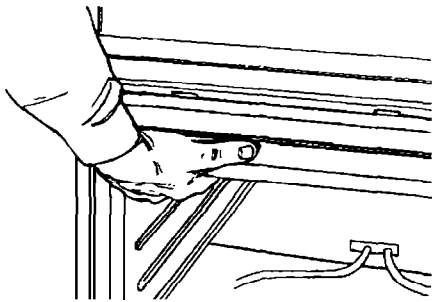
**6.**

Remove and discard shipping base. Lift oven up into cabinet cutout using the oven opening as an area to grip.

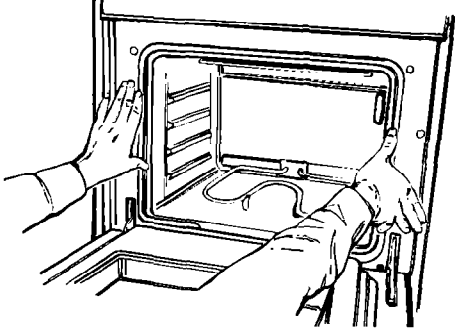

Push against seal area of front frame to push oven into cabinet.

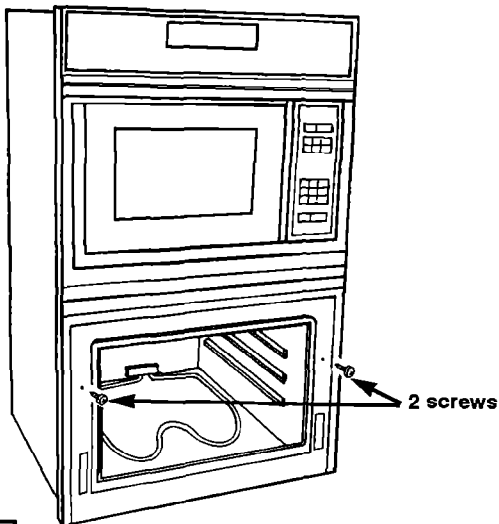

**7.** Center oven into cabinet cutout. Use two screws through the mounting holes in the front frame of the oven to secure the oven to the cabinet. Do Not overtighten screws.

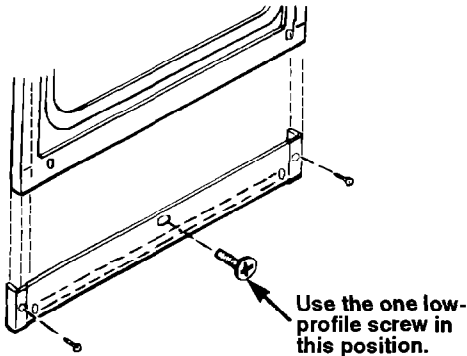

**8.** Install the lower vent grille using the three screws provided.

**9.**

Install a tray in microwave oven (if microwave oven is so equipped). Replace the oven racks. Replace the oven door by partially fitting the door hinges into the hinge slots. Pull door slightly toward you; then slide door completely in place. Reinstall the two oven-door screws (if required for your oven door). If door does not close, you have not pushed hinges completely into frame.

**10.**

Turn on the power supply. "88:88" should appear in the clock display. Press the "CLOCK SET" button. "TIME, HR AND MIN" will light in the display. "0:00" will appear and ":" will be flashing. Press the number pads for the correct time of day. Press the "START/ENTER" pad to start the clock.



Thermal convection oven control panel

**11.**

Check the operation of the BAKE element.

**Thermal-only lower oven:** Press the "BAKE" pad and "350°" will appear in the display. Press the "START/ENTER" pad to start the bake operation. "Lo" and the ON, Bake Element, Outer Broil Element and Oven Cavity symbols will light in the display. In 1-2 minutes, the bottom element should glow red. The upper element should become hot, but not glow red and the oven should be heating. Press the "CANCEL/OFF" pad.

**Thermal convection lower oven:** Press the "CONVECTION BAKE" pad and "325°" will appear in the display. Press the "START/ENTER" pad to start the bake operation. "Lo" and the ON, Convection Element and Convection Fan symbols will light in the display. In 1-2 minutes, the bottom element should glow red. The upper element should become hot, but not glow red and the oven should be heating. Press the "CANCEL/OFF" pad.

**12.**

Check the operation of the BROIL element.

**Thermal convection oven:** Press the "BROIL" pad once and "500°" and "MAXI BROIL" (if model is so equipped) will appear in the display. Press the "START/ENTER" pad to start the broil operation. The ON, Inner and Outer Broil Elements, and Oven Cavity symbols will light in the display (if model is so equipped). In 1-2 minutes, the upper element should glow red. Press the "CANCEL/OFF" pad.

**Thermal-only oven:** Press the "BROIL" pad and "500°" will appear in the display. Press the "START/ENTER" pad to start the broil operation. The ON, Inner and Outer Broil Elements, and Oven Cavity symbols will light in the display. In 1-2 minutes, the upper element should glow red. Press the "CANCEL/OFF" pad.

**13.**

Check the operation of the microwave oven.

- Place a microwave-safe container filled with one cup (250 ml) of water inside microwave oven. Close door firmly.
- Press the "COOK" pad and touch the number pads to set the cooking time to 2:00 minutes.
- Press the "START" pad. The interior microwave oven light should be on and the remaining cooking time should be displayed.
- When display reads "1:00," open microwave oven door. The microwave should stop cooking.
- Close door firmly. The interior microwave oven light should turn off.
- Press the "START" pad. Microwave oven should begin cooking and the microwave oven interior light should be on.
- Let microwave oven complete cooking time. A tone will sound four times at end of cooking time and microwave oven will shut off.
- Open microwave oven door and carefully remove container. Water in container should be hot.

*To get the most efficient use from your new oven, read your KitchenAid Use & Care Guide. Keep Installation Instructions and Guide close to oven for easy reference.*

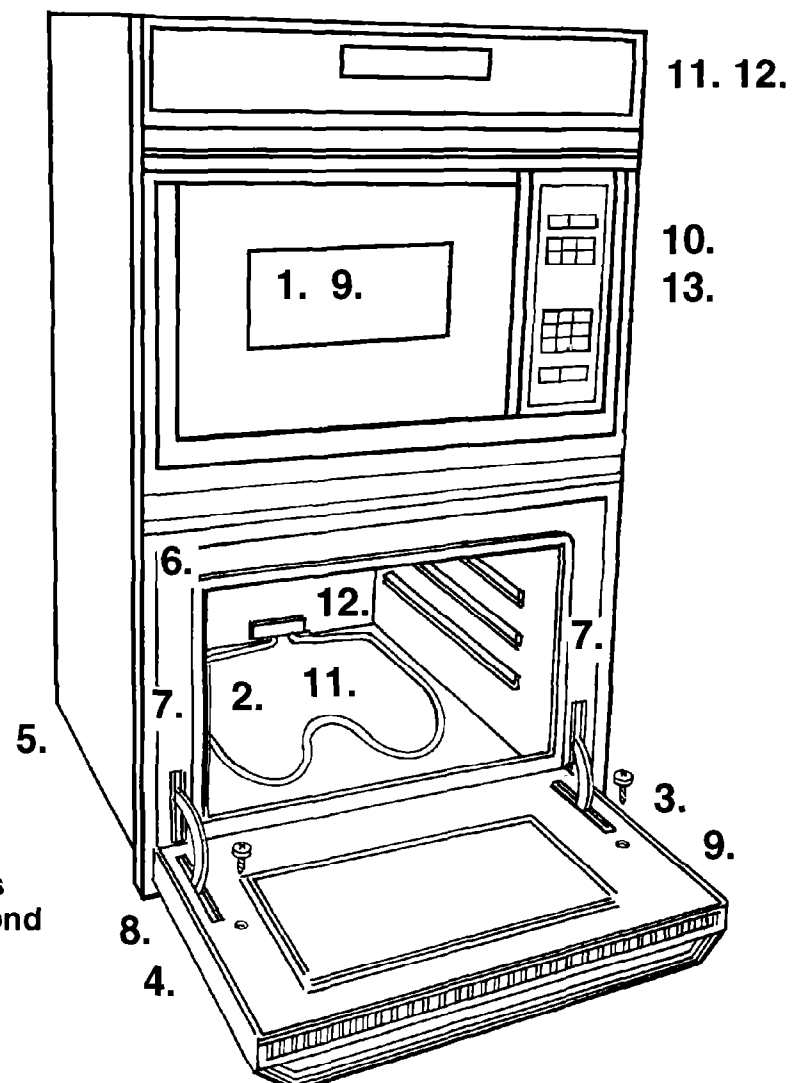

Numbers correspond to steps.

## If the range does not operate...

- Check that the circuit breaker is not tripped or the house fuse blown.
- See Use and Care Guide for troubleshooting checklist.

**NOTE:**

**Refer to Use and Care Guide for operating instructions and cleaning instructions.**

## If you need assistance...

The KitchenAid Consumer Assistance Center will answer any questions about operating or maintaining your oven not covered in the Installation Instructions. The KitchenAid Consumer Assistance Center is open 24 hours a day, 7 days a week. Just dial 1-800-422-1230 — the call is free.

When you call, you will need the oven model number and serial number. Both numbers can be found on the serial/rating plate located behind the oven door on the front frame.

## If you need service...

In the event that your KitchenAid appliance should need service, call the dealer from whom you purchased the appliance or a KitchenAid-authorized service company. A KitchenAid-authorized service company is listed in the Yellow Pages of your telephone directory under "Appliances — Household — Major — Service and Repair." You can also obtain the service company's name and telephone number by dialing, free, within the continental United States, the KitchenAid Consumer Assistance Center telephone number, 1-800-422-1230. A special operator will tell you the name and number of your nearest KitchenAid-authorized service company.



## Free Manuals Download Website

<http://myh66.com>

<http://usermanuals.us>

<http://www.somanuals.com>

<http://www.4manuals.cc>

<http://www.manual-lib.com>

<http://www.404manual.com>

<http://www.luxmanual.com>

<http://aubethermostatmanual.com>

Golf course search by state

<http://golfingnear.com>

Email search by domain

<http://emailbydomain.com>

Auto manuals search

<http://auto.somanuals.com>

TV manuals search

<http://tv.somanuals.com>