

KitchenAid SUPERBA

**Built-In Self-Clean Electric
Microwave/Single Oven with
Retained Heat[®] Cooking**

**MODEL
KEMS375**

USE & CARE GUIDE

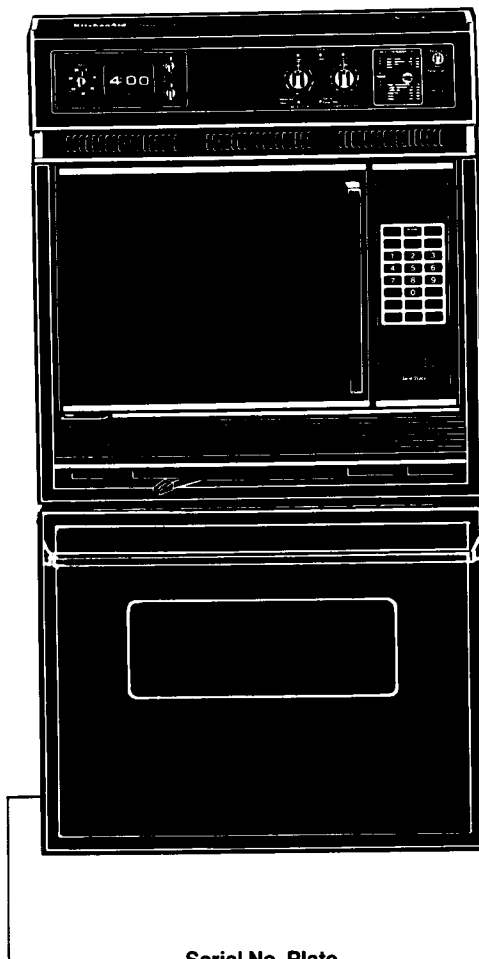

BEFORE USING OVEN

Please take a few minutes to read this booklet and learn about your KitchenAid built-in microwave/single oven.

Two Reasons

First, you have a major investment in this appliance and will use it many years. To make sure you take advantage of all the unique features we've built into the oven, read and follow the instructions. With time they will come naturally to you.

Second, this may be your first cooking experience with **RETAINED HEAT**. The special construction used in the **KitchenAid RETAINED HEAT®** oven allows you to cook with the fuel turned off.

In addition, microwave cooking is a fast, convenient and efficient method of cooking.

It is our sincere hope that you enjoy every feature of your new oven. We have tried to put in as much of our major appliance experience as we could to help keep your new KitchenAid built-in microwave/single oven working continuously for you, year after year.

Serial No. Plate

Built-In Electric Oven

Record in space below the Serial No. and Model No. recorded on the nameplate of your oven. To locate nameplate, look on left side of frame under oven door.

Serial No. _____

Model No. _____

Keep these numbers for future references.

Dealer's Name _____

Dealer's Address _____

Date Installed _____

CONTENTS

Important Precautions for Safe Microwave Cooking	4
Your Microwave Must Be Registered	4
Important Precautions for Safe Cooking	4
General Cooking Precautions	5
Oven Precautions	5
KitchenAid Built-in Oven Features	6
Control Panel Features	7
How to Use the Lower Oven	8
Preheating the Oven	8
Baking	9
Rack Arrangement	9
To Remove Oven Rack	9
Pan Placement	9
Correctly Using Foil in the Oven	9
Bakeware	10
How to use the Minute Minder	10
Baking Problems and Causes	11
Baking Time and Temperature Chart	12
Roasting	13
Oven Roasting Tips	13
Roasting Time and Temperature Chart	14
Meat Probe	15
Broiling	16
Broiling Time and Temperature Chart	17
Rotisserie	18
Preparation of Foods	18
Helpful Hints	19
Rotisserie Time and Temperature Chart	20
Automatic Oven Cooking	21, 22
Retained Heat Cooking	23, 24
Oven Care and Cleaning	25
Oven Door Removal	26
Before Starting the Self-Clean Cycle	27
Oven Self-Cleaning Tips	28, 29
Special Information	30
When You Need Service	31
Warranty	32

IMPORTANT SAFETY INSTRUCTIONS

The **KitchenAid Microwave Oven** is designed and thoroughly tested to meet exacting safety standards. It meets UL and FCC requirements and complies with safety performance standards of the U.S. Department of Health and Human Services.

Before using the **Microwave Oven**, please read the instructions for microwave cooking in the separate booklet titled "Use and Care of Your Microwave Oven."

Precautions to Avoid Possible Exposure to Excessive Microwave Energy

1. **Do Not Attempt** to operate this oven with the door open since open door operation can result in harmful exposure to microwave energy. It is important not to defeat or tamper with the safety interlocks.
2. **Do Not Place** any object between the oven front face and the door or allow soil or cleaner residue to accumulate on sealing surfaces.
3. **Do Not Operate** the oven if it is damaged. It is particularly important that the oven door closes properly and that there is no damage to the:
 - (a) **Door** (bent)
 - (b) **Hinges and Latches** (broken or loosened)
 - (c) **Door Seals and Sealing Surfaces.**
4. **The Oven Should Not Be Adjusted or Repaired by Anyone Except Properly Qualified Service Personnel.**

IMPORTANT Your Microwave Oven Must Be Registered

It is a federal requirement that records be maintained on locations of all microwave ovens. Please fill out the information on the registration card packed in the literature.

1. Be certain that you fill out the registration card and mail it to us. It is most important that you do this.
2. If you move, please renew your registration by writing to us at:
KitchenAid Division
Hobart Corporation
Microwave Oven Registration
Troy, Ohio 45374
3. If you are not the original purchaser of this appliance, please establish your ownership by writing to the above address.
4. When writing to us about your microwave oven, please be sure to include:
Model Number
Serial Number
Date of Manufacture
Date of Purchase

IMPORTANT PRECAUTIONS FOR SAFE COOKING

Many years of safe and happy cooking experiences can be enjoyed by following the rules of safe operation when using your oven. Each person who uses the oven should learn these rules

and operating instructions. Our product has been designed with safety in mind, now we ask you to do your part, please read and become familiar with the following rules.

General Cooking Precautions

1. Be sure your oven is properly installed and grounded by a qualified technician.
2. Never Use Your Oven for Warming or Heating the Room.
3. Do Not Touch Heating Elements or Interior Surfaces of the Oven— Heating elements may be hot even though they are dark in color. Interior surfaces of an oven become hot enough to cause burns. During and after use, do not touch, or let clothing or other flammable materials contact heating elements or interior surfaces of oven until they have had sufficient time to cool. Other surfaces of the appliance may become hot enough to cause burns— among these surfaces are oven vent openings and surfaces near these openings, oven doors and windows.
4. Children should not be left alone or unattended in area where oven is in use. They should never be allowed to sit or stand on any part of the oven.
5. Wear Proper Apparel— Loose fitting or hanging garments should never be worn while using the oven. Also fasten long hair when operating the oven.
6. Do Not Use Water on Grease Fires— Smother fire or flame or use dry chemical or foam-type extinguisher.
7. Use Only Dry Potholders— Moist or damp potholders or towels on hot surfaces may result in burns from steam. Do not let potholder or towel touch hot heating elements.
8. Do Not Heat Unopened Food Containers— Build-up of pressure may cause container to burst and result in injury.
9. Know where your main oven electrical switch is located. It is important to know this in case the electrical power to your oven needs to be turned off. Have the installer show you where it is located.
10. Never let aluminum foil touch heating elements.

OVEN PRECAUTIONS

1. Do not repair any part of the oven unless specifically recommended in this manual. All other servicing should be referred to a qualified technician.
2. Flammable materials should not be stored in or near the oven.
3. Use Care When Opening Door— Let hot air or steam escape before removing or replacing food.
4. Keep Oven Vents Unobstructed.
5. Always place oven racks in desired locations while oven is cool. If rack must be moved while oven is hot, do not let potholder contact hot heating element in oven.
6. Never touch an oven light bulb with a damp cleaning cloth unless the power is turned off to your oven and bulb is cool to touch.
7. Clean Your Oven Regularly. See Care and Cleaning Instructions.
8. Do Not Clean Door Gasket— It is essential for a good seal. Care should be taken not to rub, damage, or move the gasket. Hand clean only areas recommended in this booklet.
9. Do Not Use Oven Cleaners— No commercial oven cleaner or oven liner protective coating of any kind should be used in or around any part of the oven.
10. Before Self-Cleaning the Oven— Remove broiler pan, broiler grid, oven racks and other utensils. (Do not use your oven to clean miscellaneous parts.)
11. **CAUTION**— Do Not store items of interest to children in cabinets above your oven. Children climbing on the oven door to reach items could be seriously injured.

KitchenAid BUILT-IN OVEN FEATURES

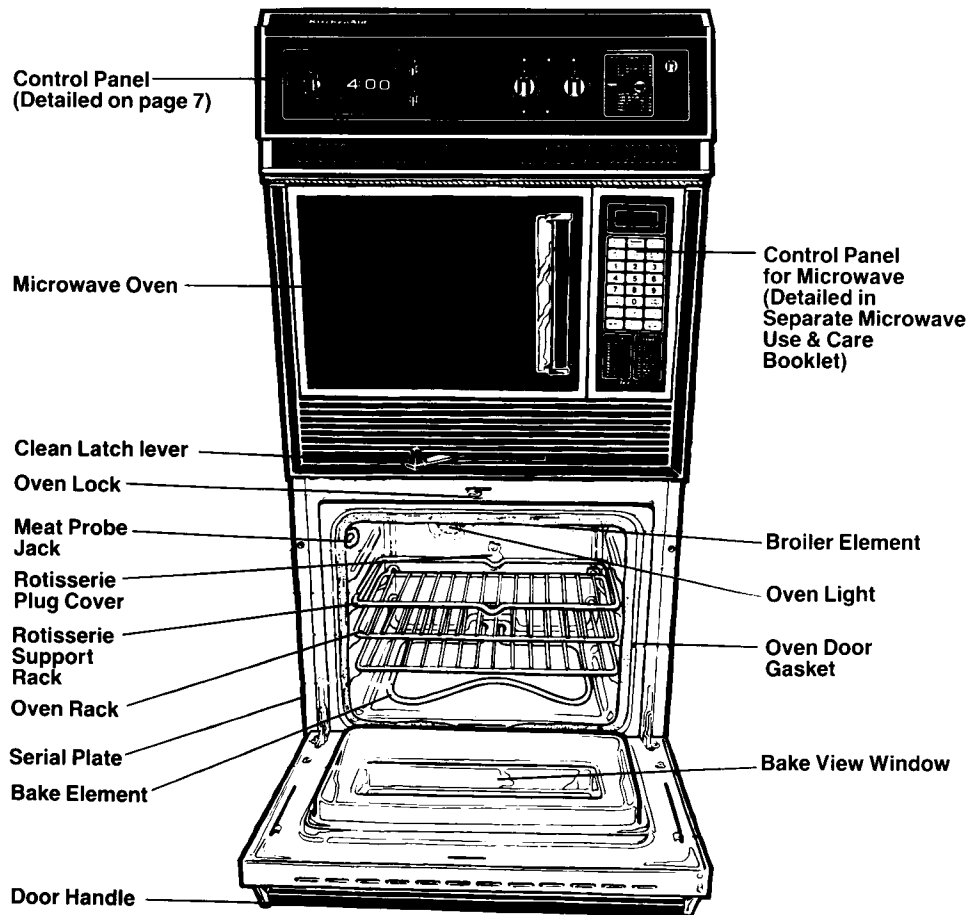

CONTROL PANEL FEATURES

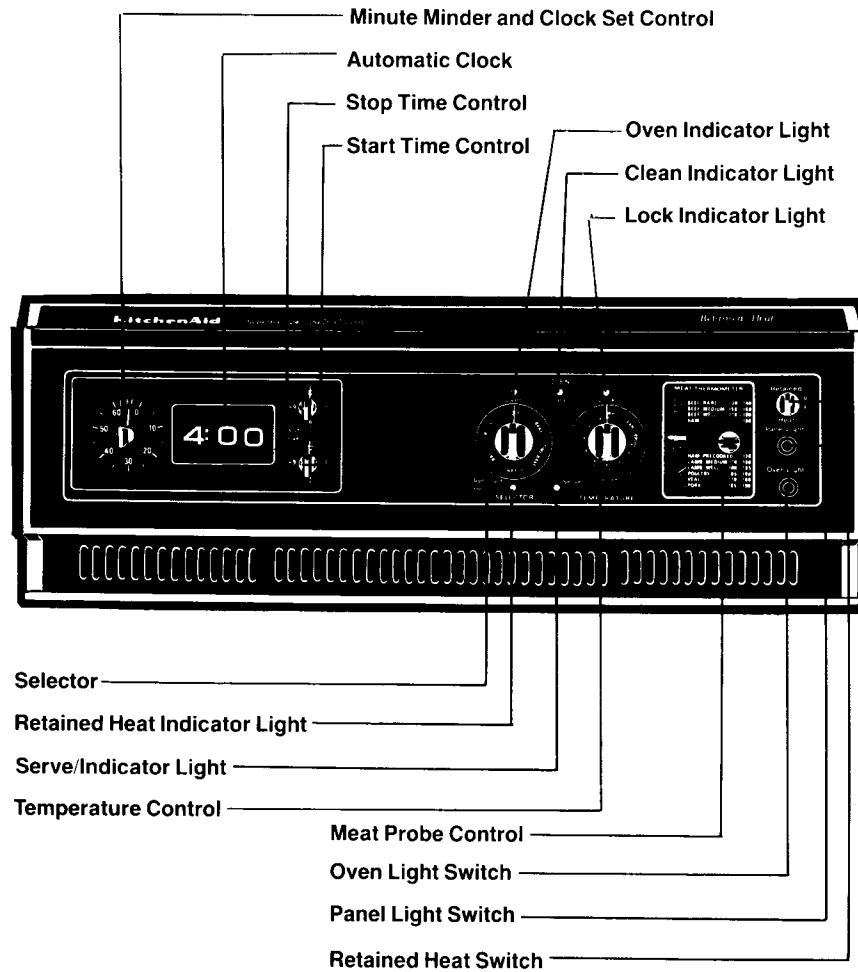

HOW TO USE THE LOWER OVEN

The oven is used for baking, roasting, broiling and rotissing. It has two controls—a **selector** and a **temperature control**. Both of these must be set for the oven to work.

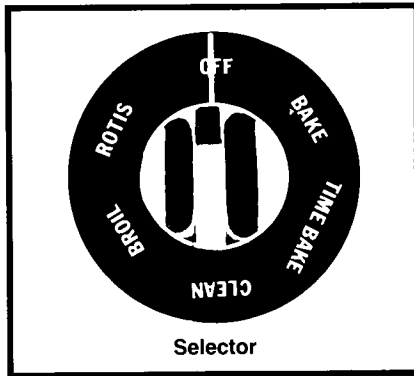

NOTE: When both upper and lower elements are on, the upper element operates at a lower wattage to aid in a more uniform baking pattern. Because of this lower wattage, the upper element does not turn red like the lower element which is at full power.

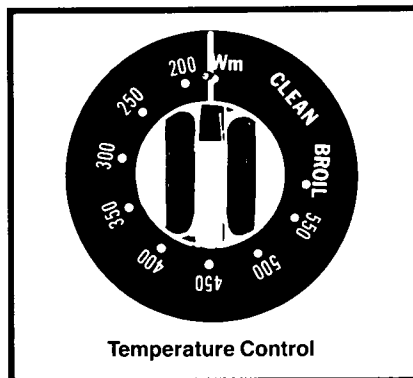

NOTE: Be sure that selector is turned to "OFF" and temperature control is set against low end stop when use of oven is completed.

Selector

The selector has six settings:

Clean—Use this setting for self-cleaning only.

Broil—Use this setting for broiling. Only the upper element heats.

Time Bake—Use this setting for cooking with clock (automatic cooking). Both the upper and lower elements heat.

Bake—Use this setting for baking and roasting. Both the upper and lower elements heat.

Rotis—Use this setting when using the rotisserie. Only the upper element heats.

Off—Use this setting to turn the oven "OFF."

Temperature Control

Set oven temperature control for temperature desired from 170° to 550°F. The 170°-225°F temperatures provide good warming and holding temperatures.

Preheating the Oven

For best results, preheat the oven unless the recipe states otherwise. Set the **selector** to "BAKE" and **temperature control** to the desired temperature. Exercise care in turning the **temperature control** not to go past the desired set point. If setting is past, return control to last stop and reset **temperature control** to desired setting. The **oven indicator light** will go out when the desired temperature has been reached.

BAKING

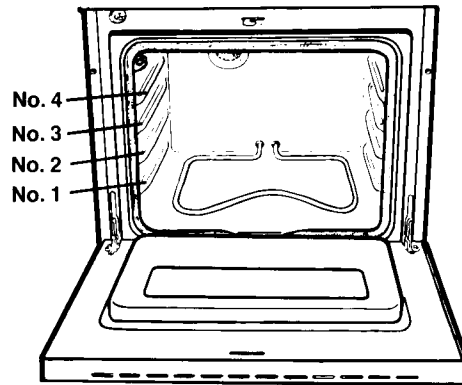

Rack Positions

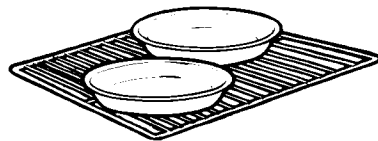
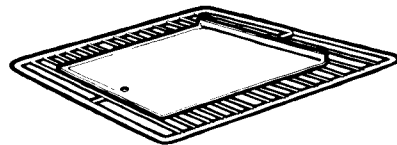
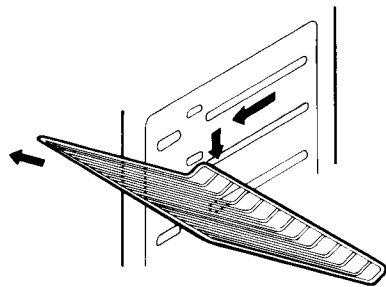

Rack Arrangement

The rack(s) should be arranged before preparing foods or turning on the oven. The oven has four rack positions. Position No. 4 refers to the highest, farthest from the bottom of the oven. Rack position No. 1 refers to the lowest, closest to the oven bottom.

To Remove Oven Rack

Slide rack forward until bar on back of rack touches first stop.

Lift front of rack until rear portion of rack slides out between front two stops.

Pan Placement

When using a large flat pan that covers most of the rack, it is best to use only one rack. When two racks and several pans are used, it is best to stagger the pans so that no pan is directly above another pan. Normally $1\frac{1}{2}$ to 2 inches of air space should be allowed on all sides of each pan in the oven. Even pan placement provides air circulation for proper baking and browning. If using a large roasting pan or cookie sheet, turn the pan so that it has the most air flow possible—the pan's long side may be parallel to the oven door. This is to insure the best heat distribution.

Correctly Using Foil in the Oven

If you wish to use foil for possible spills, cut a piece of foil slightly larger than the pans and turn up the edges. Place the foil on the oven rack below the pan. NEVER COVER AN ENTIRE OVEN RACK OR OVEN BOTTOM WITH FOIL. THE FOIL CAN OBSTRUCT NORMAL HEAT FLOW, CAUSE COOKING FAILURES AND DAMAGE THE OVEN INTERIOR.

NOTE: Moisture from normal oven cooking may appear on the grill located below the control panel. This is where the oven is vented. The moisture collection will be more noticeable when cooking heavy moist oven loads. It will disappear as the oven heats up except in the case of an extremely moist load.

BAKING

Bakeware

- To insure good baking results, use the proper pans. Old or darkened pans are not desirable.
- Tin-coated, stainless steel, warped or dented pans do not heat evenly and will cause uneven baking.
- Cakes, cookies, quick breads and muffins should be baked in shiny pans, because they should have a light, tender, golden crust.
- When using glass pans, reduce oven temperature by 25° except when baking pies or yeast breads.
- Cookies, biscuits or cream puffs bake best on medium weight aluminum sheets with no sides or very low sides.
- Size of the pan should be that recommended in the recipe.

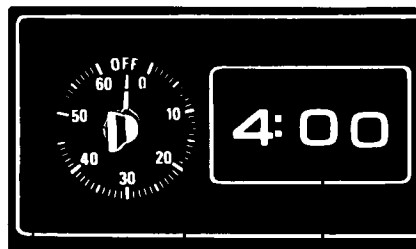
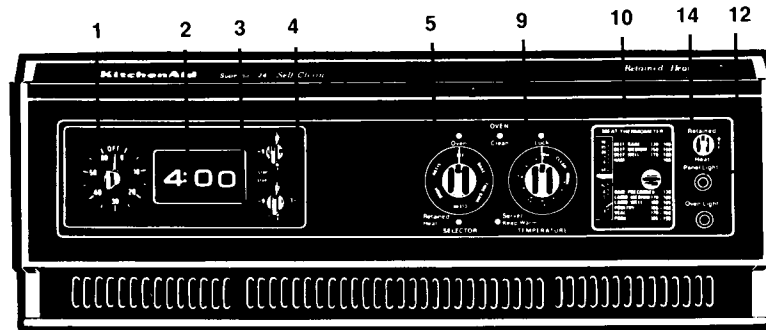

Minute
Minder
Control

Minute
Minder
Hand

Time
of Day

CAUTION:

The **clean latch lever** should be positioned to the left (unlocked) at all times except when **selector** and **temperature control** are in "CLEAN."

To Use for Regular Baking

1. Set the **temperature control** (9) to the desired temperature.
2. Turn the **selector** (5) to "BAKE."

How to use the Minute Minder

The **minute minder** is the large dial on the left side of the clock. To use the minute minder (1), turn its control to the right until the white hand points to the desired number of minutes up to a maximum of 60. At the end of the set time, a buzzer will buzz and the white hand will point to "0." After the buzzer signal, turn the control until the white hand points to "OFF." This is a reminder only and will not turn the oven "ON" or "OFF."

Baking Tips

- Set the oven controls before placing pans in the oven.
- Avoid opening the oven door when baking. Heat is lost and improper baking may result. Use the Bake View oven window to conserve energy.

- Use the minute minder to time cooking functions. (For the recommended baking time see page 12.)
- Wait until the shortest recommended baking time is over before checking food.
- Be sure all controls are set to the "OFF" position when cooking has been completed.
- When baking two sheets of cookies at the same time, each sheet should be removed when desired degree of doneness is reached.

BAKING PROBLEMS AND CAUSES

PROBLEMS	CAUSES
Cookies and biscuits:	
<ul style="list-style-type: none"> • too brown on top 	<ul style="list-style-type: none"> • the pan was set too high in the oven OR • the selector switch was left on "BROIL" during baking OR • if aluminum foil is used, it may distribute the heat unevenly in the oven OR • the pan's sides are too deep OR • the pan is too wide or too long for the oven OR • the oven rack is overcrowded—NOTE: Pan placement on page 9
<ul style="list-style-type: none"> • browning more on one side than the other 	<ul style="list-style-type: none"> • the pan was set too close to one side of the oven OR • the oven door was not closed properly.
Cakes:	
<ul style="list-style-type: none"> • rises higher on one side 	<ul style="list-style-type: none"> • the batter was spread unevenly in the pan OR • the pans were set too close to the sides of the oven OR • oven is not level OR • pans were warped.
<ul style="list-style-type: none"> • burns on the sides 	<ul style="list-style-type: none"> • there were too many pans or the pans were too large for the oven OR • the oven was too hot.
<ul style="list-style-type: none"> • cracks on the top 	<ul style="list-style-type: none"> • the batter was too thick OR • the pan was not the correct size OR • the pan was not centered in the oven.
Pies:	
<ul style="list-style-type: none"> • burns around the edges 	<ul style="list-style-type: none"> • the oven was too hot OR • there were too many pans or the pans were too large for the oven OR • the pans were too dark.
<ul style="list-style-type: none"> • too light in color on the top 	<ul style="list-style-type: none"> • the oven was not hot enough OR • the oven was too full, cutting off even heat distribution.

BAKING TIME AND TEMPERATURE CHART

Food	Oven Temp. Degrees F.	Approx. Time-Min.	Food	Oven Temp. Degrees F.	Approx. Time-Min.
Breads:			Cookies:		
Yeast-loaf	375	40-45	brownies	350	20-30
rolls, pan	400	12-15	macaroons	350	12-15
Breads:			Miscellaneous:		
Quick-biscuits	450	10-15	apples, baked	375	50-60
muffins	400	20-25	beans, baked	300	5-6 hrs.
popovers	450	20-25	custard		
corn bread	425	25-30	casserole	325	45-60
nut bread	350	60-75	cup	325	30-45
gingerbread	350	25-30	potatoes, baked	400	60-90
Cakes:			pudding		
angel cake	350	45-55	bread	350	45-60
cup cake	350-375	20-25	cottage	375	30-40
layer cake	350-375	25-40	rice	325	40-60
loaf cake	350	35-45	scalloped dishes	350	60-90
sponge cake	350	35-45	souffle	350	50-60
pound cake	350	35-40	Pastries:		
fruit cake	300	2-2½ hrs.	cream puffs	400	35-40
sheet cake	300	25-35	custard and		
Cookies:			pumpkin pie	350	30-40
drop	375	10-15	pastry shell	450	10-12
rolled and			two crust fruit pie		
refrigerated	375	8-12	cooked filling	400	25-30
chocolate	375	10-15	uncooked filling	400	40-50
fruit and molasses	375	10-15	meringue topping	350	10-15

High Altitude Baking

When baking at high altitudes, recipes and baking times vary. For accurate information write the Extension Service of your state college or university or Extension Service, Colorado State University, Fort Collins, Colorado 80523. There may be a cost for the bulletins—do specify the type of information you want (i.e. cakes, cookies, breads, etc.).

ROASTING

Roasting is a dry heat cooking process (as opposed to broiling which is a direct heat process). Roasting is recommended for poultry and tender cuts of beef, lamb, pork and veal. Always place the meat with the fat side up for self-basting.

OVEN ROASTING TIPS

Rack Arrangement

Before preparing your meat, arrange the oven racks to the desired position.

Roasting Pan

Most of the temperature and time charts recommend using a shallow, open pan with the meat on a rack. Use a roasting pan that fits the size of the meat. A pan that is too small will allow the meat to hang over the edge. Too large a pan results in increased oven spatter. Spatter can be reduced by lining the bottom of the roasting pan with lightly crushed aluminum foil.

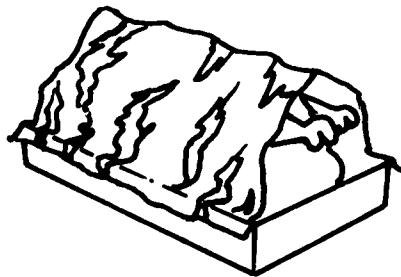

Foil Tent

Roasting with Foil

A foil "tent" can be used to slow down surface browning. This works well on a large turkey. Tent-shaped foil should be placed loosely over the meat. This allows oven air to circulate under the foil. Sealing the foil will tend to steam the meat.

Oven Temperature

Note roasting chart on page 14.

ROASTING TIME AND TEMPERATURE CHART

Meat Cut	Weight in Pounds	Oven Temperature Setting	Approx. Minutes Per Lb.	Internal Temp. Degrees F.
Beef Rolled Rib				
rare	5-6	325	30	140
medium	5-6	325	35	150
well done	5-6	325	45	170
Standing Rib				
rare	6-7	325	25	140
medium	6-7	325	30	150
well done	6-7	325	40	170
Rump Roast				
medium	4-6	325	25	150
well done	4-6	325	30	170
Lamb Leg (half)				
	3-4	325	35	180
	6-7	325	30	180
Fresh Pork				
Loin	4-5	325	35	170
Shoulder	4-5	325	40	185
Poultry				
*Chicken	3-7	425	30	***
Duck	10-12	325	25	***
Goose	6-10	325	25	***
**Turkey	10-16	325	20	170-175
	18-25	325	18	170-175
Fully Cooked Ham				
	3-5	325	18	130
	8-10	325	15	130
Veal				
Loin	3-4	325	35	170
Shoulder	5-6	325	45	170

*Add 15 minutes if chicken is stuffed

**Add 30 minutes if turkey is stuffed

***The muscles are not usually large enough to use a thermometer.

MEAT PROBE

(Single/Upper Oven Only)

The **meat probe** is the most accurate guide to the degree of doneness of meat. Cooking time is often used as a guide to the degree of doneness, but at best it is only an estimate. The meat probe registers the internal temperature of the meat or its degree of doneness.

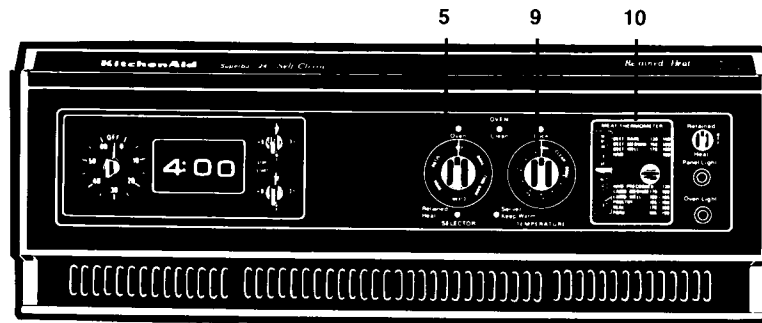

To Use the Meat Probe

1. Insert the **probe** into the center of the thickest portion of meat or into the inner thigh or breast of poultry, away from fat or bone.
2. Place pan with meat on rack that has been centered in the oven.
3. Open **meat probe cover** located on the left side of the oven wall. Insert plug into the jack. (Keep the top of the probe as far as possible from the heat source.)
4. Close oven door.
5. Set the **meat thermometer hand** (10) to the desired setting. (See Roasting Chart for internal meat temperatures on page 14.)
6. Set **selector** (5) to "BAKE."
7. Set **temperature control** (9) to desired temperature.

NOTE: Because of the oven's superior construction, cool down time may need to be figured into the timing for the proper degree of doneness.

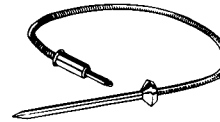

This is What Happens

The oven light will come on and cycle on and off at the same temperature. The red hand (10) on the meat thermometer dial will move up the scale indicating the internal meat temperature. When the red hand reaches the white hand (desired internal meat temperature), the element will turn off and the oven will begin to cool off.

To Remove Meat Probe

1. Open oven door.
2. Unplug the meat probe and replace the cover over the jack opening. Remember oven, probe, and probe cover are hot.
3. Turn **selector** and **temperature control** to "OFF."

NOTE: Do *not* immerse probe into water. Wipe the probe with a wet hand towel to clean.

BROILING

Broiling is a quick-cook method that will produce foods that are brown on the outside and moist and juicy on the inside.

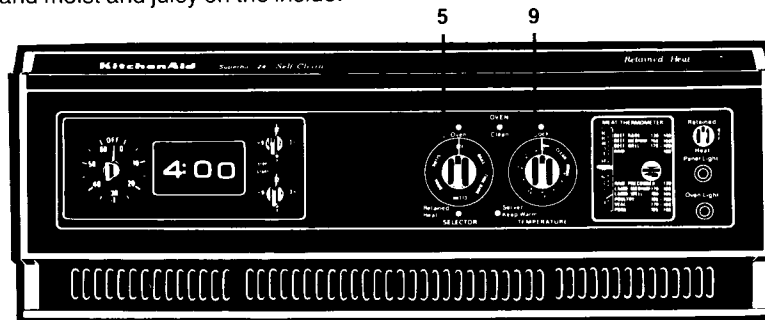

To use the Oven for Broiling

1. Adjust the oven racks into the desired position. (See Broil Chart, page 17). Place food on grid on broiler pan and place in the center of the oven rack.
2. Set the **temperature control** (9) to recommended temperature on chart.
3. Turn the **selector** (5) to "BROIL." Do not preheat the broiler.
4. Close the oven door.

REMEMBER:

Covering the broiler grid with foil is not recommended. Poor drainage of hot fat may result in a broiler fire. If foil must be used, make sure slots are cut in foil to correspond to all openings in the broiler grid. Fat can then drip away from meat and be cooled in the pan.

Helpful Hints

- Always start food on a cold broiler pan for even broiling.
- It is best not to pierce meat with a knife or fork as this allows the juices to escape.
- Broil food on one side for slightly more than $\frac{1}{2}$ the recommended time, then season and turn it. Season the second side just before you remove it from the broiler.
- Trim the outer layer of fat from steaks and chops.
- Slit the fatty edges to prevent the meat from curling.
- Brush food with butter, sauce or seasoning, if desired, several times as they broil.
- When broiling fish, grease the broiler pan grid to prevent sticking.

BROILING TIME AND TEMPERATURE CHART

Recommended rack position numbered lowest (1) to highest (4)

Food	Rack Position	Temperature Setting	Approximate Total Time
Steak — 1" thick			
rare	3	550°	13-15 min.
medium	3	550°	15-20 min.
well done	3	550°	20-25 min.
Steak — 1½" thick			
rare	3	550°	15-20 min.
medium	3	550°	20-25 min.
well done	3	550°	20-25 min.
Hamburger Patties	3	450°	15-20 min.
Lamb Chops — 1" thick	3	400°	20-30 min.
Ham Slice — 1" thick	3	400°	20-25 min.
Bacon	3	400°	5-7 min.
Frankfurters	3	400°	10-12 min.
Chicken Halves	1 or 2	400°	60-70 min.
Fish	2	350°	20-25 min.
Calves Liver	3	350°	10-12 min.
Tomato Halves	3	550°	8-10 min.
Orange or Grapefruit	2	550°	8-15 min.

ROTISSERIE

Rotissing consists of roasting food on a spear while it is exposed to a heat source. Most meat that can be broiled or roasted can be rotissed. Select tender cuts of meats and prepare them as for oven roasting.

PREPARATION OF FOODS

Roasts

Rolled roasts are ideal for rotissing because they are easier to balance. Insert the spear straight down the center. Meat cuts that have bones require planning for even distribution.

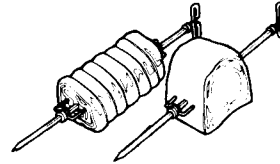

Ribs

When rotissing more than one item or a long item, such as a spare rib strip, it's best to space the foods or pieces. When rotissing ribs— weave the spear in and out of ribs forming accordion folds. Browning and cooking are slower where the pieces press against each other.

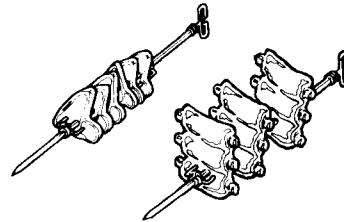

Poultry

Dress poultry as for oven roasting.

Season inside of cavity as preferred. (Stuffing can be used if desired.)

Close any openings with metal or wood skewers or sew with string thread. Fasten the wings and the legs close to the body with poultry pins or thread.

For best results, brush the poultry with butter or oil and baste every 20-30 minutes during the rotissing time.

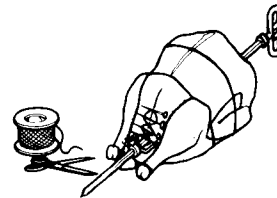

Basting

Use a favorite sauce and baste the meat several times during cooking. If desired, marinate the meat several hours or overnight in the refrigerator.

REMEMBER:

When rotissing, place a foil-lined broiler pan under the meat to catch drippings.

ROTISSERIE

Using the Rotisserie

1. Slide the rotisserie support rack into rack position #3 (second rack position) from the top so spear will fit into the drive socket located at the back of the oven.
2. Place the broiler pan on the oven rack position #1 (lowest position) so it catches the drippings.
3. Remove the prong nearest the pointed end of the spear. Center the meat on the spear. Slide the prong which was removed back onto the spear. Slide both prongs into the meat and tighten thumbscrews.
4. Place spear with food on the support rack. Swing the cover plate to the side and insert the spear all the way into the drive socket in the rear oven wall.
5. Set the **temperature control** to the desired temperature. (See rotisserie chart on page 20.)
6. Turn the oven **selector** to "Rotis." The broil element will then come on and the spear will start to turn.
7. Close the oven door. Do not preheat the oven.
8. The rotisserie may be stopped while spear is in place by turning **selector** to "OFF" position.
9. To remove the rotisserie spear from the oven, grasp the support rack with a potholder and pull it out. **BE CAREFUL WITH THE SPEAR AND SUPPORT RACK. THEY WILL BE HOT.**

NOTE:

Meat should be no longer than the rotisserie spear with a diameter of seven (7) inches or less. Be sure the meat rotates smoothly without wobbling and doesn't touch the rack or pans as it rotates.

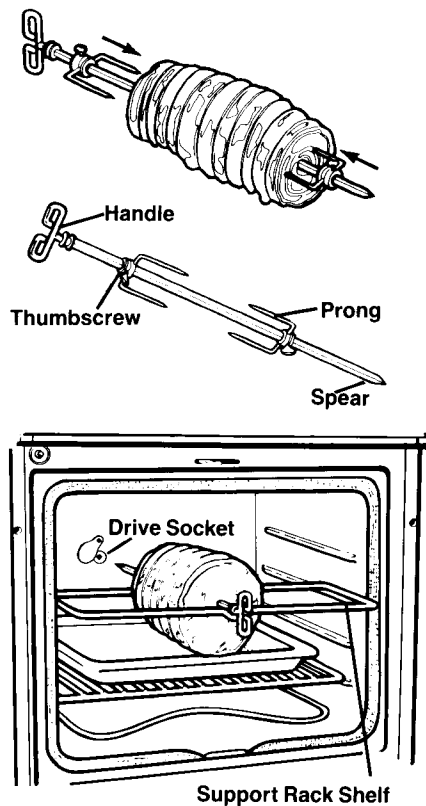

- When oven is cool, be sure the cover plate is over the drive socket opening.
- Meats are juicier and easier to carve when allowed to stand or rotate on a spear 10-15 minutes after the heat is turned off.
- Make sure the thumbscrews on the prongs are tight. If prongs loosen under the weight of the meat, the spear will turn within the meat and heat will be concentrated on one side.

ROTISSERIE TIME AND TEMPERATURE CHART

Meat	Approximate Weight	Internal Temp. With Thermometer	Temperature Settings	Approximate Total Time
Beef				
rolled rib roast	4-7 lbs.	Rare 140°	400°	1 ¼ to 2 hrs.
rolled rump roast	4-7 lbs.	Medium 160° Well Done 170°	400° 400°	1¾ to 2½ hrs. 2 to 3 hrs.
Pork				
rolled loin roast	3-5 lbs.	185°	375°	1¾ to 2½ hrs.
rolled shoulder roast	3-6 lbs.	185°	375°	1¾ to 3 hrs.
spareribs	1½-4 lbs.	185°	375°	time will depend on leanness
Canadian bacon	3-4 lbs.	185°	375°	1 to 1½ hrs.
half ham — ready to eat — tenderized	6-7 lbs.	140° 160°	375° 375°	1½ to 2 hrs. 2 to 2½ hrs.
Veal				
rolled rump roast	3-5 lbs.	170°	400°	1½ to 2½ hrs.
Lamb				
rolled leg	3-5 lbs.	180°	400°	1¾ to 2½ hrs.
rolled loin roast	3-5 lbs.	180°	400°	1¾ to 2½ hrs.
Poultry				
chicken-broiler-fryer	2½-3½ lbs.	190°	450°*	1 to 1½ hrs.
cornish hen	1 lb.	190°	425°	50 to 55 min.
duck	5-6 lbs.	190°	425°	1½ to 2 hrs.
Bologna roll			400°	heat thru
Frankfurters			425°	15 to 20 min.
Kabobs			425°	heat thru

Rotisserie times given in the chart are approximate. Actual cooking time depends upon meat diameter and meat composition (proportion of fat to lean). It is best to use a meat thermometer to determine doneness by interior temperature.

*For crisp, brown bird, turn temperature control to 550°F the last 5 minutes of rotissing.

AUTOMATIC OVEN COOKING

Automatically operates the oven to start now and maintain the set temperature for the selected number of cook hours.

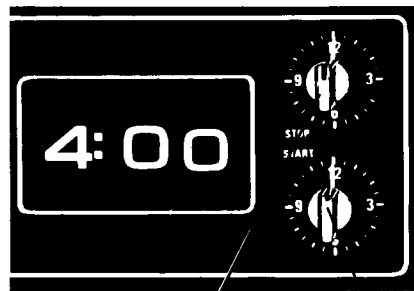
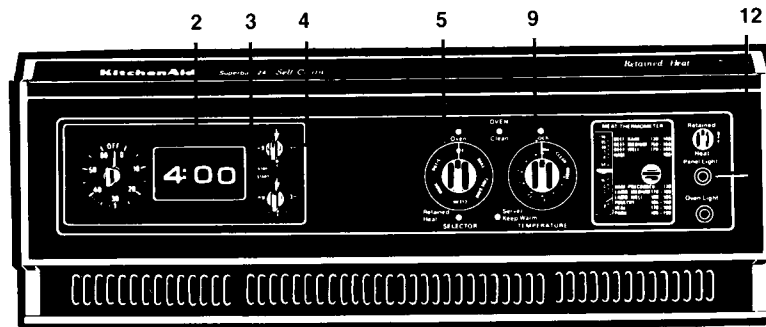

Stop Time Control Start Time Control

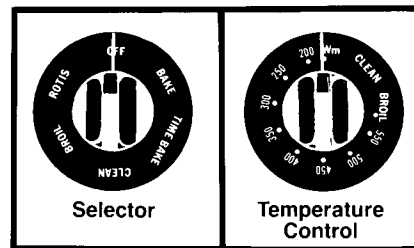

To Set Time of Day

To set **Digital clock** (2) push in the minute minder control and turn until the correct time appears. Note that the minute timer hand will also turn. Reset the minute timer hand by turning the

control to the right (do not push knob in) to the "OFF" position.

To Start Now (automatically stops later)

1. Check **start time control**. If it does not correspond with the time on oven clock, push in and turn (3) until it "pops out" and shows the same time as the oven clock.
2. Set **stop time control**. Push in and turn (4) to the time you want the heating element to shut off.
3. Set **temperature control**. Turn (9) to desired cooking temperature.
4. Set **selector**. Turn (5) to "TIME-BAKE"
5. Set **RETAINED HEAT switch**. Turn (12) to "OFF".

This is what happens

- The oven will come on immediately. The oven will maintain the temperature set by the control.
- At the end of the cooking period the oven will go off. The Serve light comes on and stays on until the oven controls are manually turned off.

NOTE: When setting the stop time dial each click to the right past the position of the "Start Time" is approximately 15 minutes cooking time.

AUTOMATIC OVEN COOKING

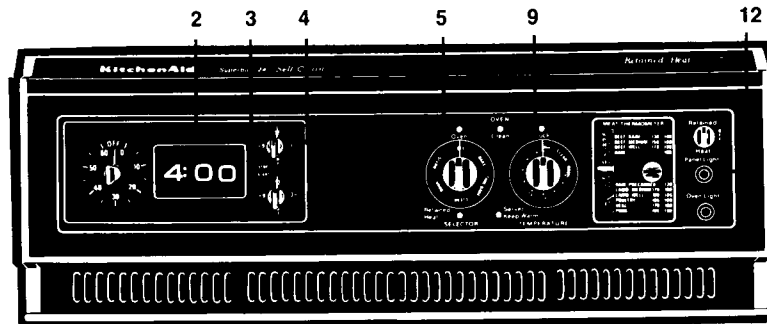

To Start Later (automatically stops later)

Check to see if clock time is set to the correct time of day.

1. Set **start time control**
Push in and turn (3) to the hour you want the oven to come on.
2. Set **stop time control**
Push in and turn (4) to the time you want the heating element to shut off.
3. Set **temperature control**
Turn (9) to desired cooking temperature.
4. Set **selector**
Turn (5) to "TIME-BAKE."
5. Set **RETAINED HEAT switch**
Turn (12) to "OFF."

This is what happens

- The oven will come on at the future time set and will maintain the set temperature for the selected cook time.
- At the end of the cooking period, the oven turns off. The **Serve light** comes on and stays on until the oven controls are manually turned off.

REMEMBER:

When you remove the food:

1. Turn the **temperature control** (9) to maximum counterclockwise (left) position.
2. Turn the **selector** (5) to "OFF."

RETAINED HEAT COOKING

When normal cooking is performed in an oven, the heating elements heat the oven cavity to maintain the set temperature. A great amount of this heat escapes from the oven which is wasted. The KitchenAid RETAINED HEAT oven is specially constructed around the oven cavity and around the door so that this heat is "Retained" in the oven cavity to be used for cooking food. When using the RETAINED HEAT method, the baking time and temperature should be changed on regular recipes. The time should be shorter and temperature should be higher.

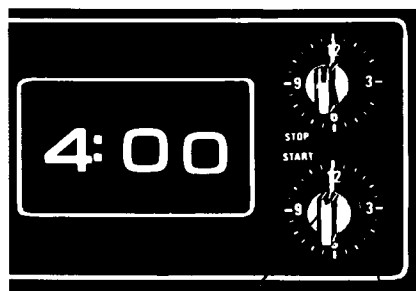

Start
Time
Dial

Stop
Time
Dial

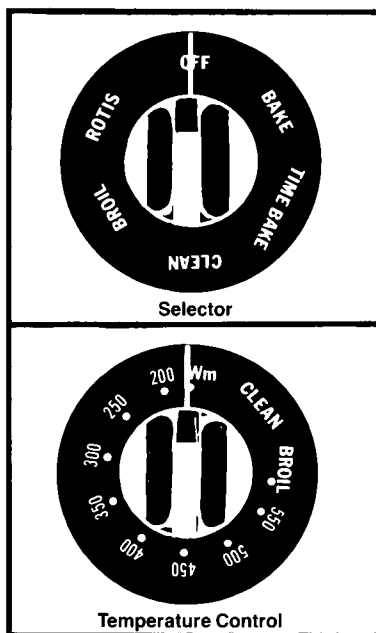

Selector

Temperature Control

To Start Now (automatically stops later)

Check to see if clock time is set to the correct time of day.

1. Set **start time control**

If it does NOT correspond with the time on the oven clock (2) then turn start time control (3) until it "pops out" and shows the same time as oven clock.

2. Set **stop time control**

Push in and turn to the time you want the heating element to shut off. Each click to the right past the position of the "Start Time" is approximately 15 minutes cooking time.

3. Set **temperature control**

Turn (9) to desired cooking temperature.

4. Set **selector**

Turn (5) to "TIME-BAKE."

5. Set **RETAINED HEAT switch**

Turn (12) to "RETAINED HEAT."

This is what happens

- The oven will come on immediately and will maintain the set temperature for the selected cook time.
- At the end of the "power on" period, the oven will begin cooking with Retained Heat which is indicated by the Retained Heat light (14).
- At the end of Retained Heat cooling, the oven will be maintained at 165° by the Keep Warm thermostat. The Retained Heat light and oven light with elements will cycle on and off. Refer to "Recipes for Success" cookbook for suggested cooking times.

RETAINED HEAT™ COOKING

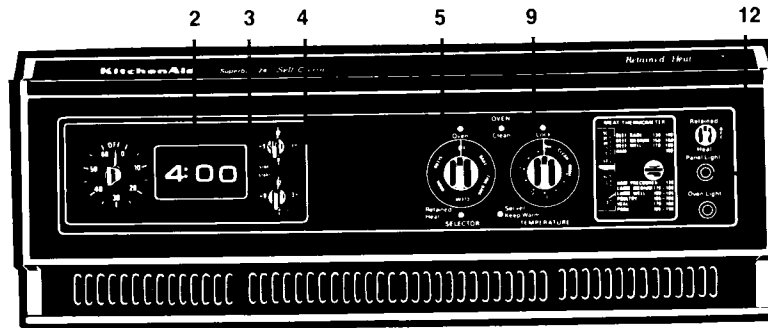

To Start Later (automatically stops later)

Check to see if clock time is set to the correct time of day.

1. Set **start time control**

Push in and turn (3) to the hour you want the oven to come on.

2. Set **stop time control**

Push in and turn (4) to the time you want the burner to shut off.

3. Set **temperature control**

Turn (9) to desired cooking temperature.

4. Set **selector**

Turn (5) to "TIME-BAKE."

5. Set **RETAINED HEAT switch**

Turn (12) to "RETAINED HEAT."

This is what happens

- The oven will come on at the future time set and will maintain the set temperature for the selected "power on" period.
- At the end of the "power on" period the oven will begin cooking with

Retained Heat (indicated by the Retained Heat light).

- At the end of Retained Heat cooking, the oven will be maintained at 165° by the Keep Warm thermostat. The Retained Heat light and oven light with elements will cycle on and off.

The maximum combined Delay plus Cook time for the oven time is 11¾ hours. This means the oven cannot be set at 8 p.m. (in the evening) to come on the next day at 2 p.m. (in the afternoon). The oven would come on at 2 a.m. (in the morning).

REMEMBER:

When you remove the food:

1. Turn the **temperature control** (9) to maximum counterclockwise (left) position.
2. Turn the **selector** (5) to "OFF."

OVEN CARE AND CLEANING

Several finishes have been used on this oven. Some require special attention to the cleaning agents used to prevent damage to the finish. The care of the inside of the oven and door are explained in detail on the pages that follow.

Part	Finish	Clean With
Broiler Pan	Porcelain Enamel	Detergent and hot water. Soap-filled steel wool pad with plenty of water. Rinse well.
Oven Racks Rotisserie Spear and Prongs	Nickel Plating	Detergent and hot water.
Broiler Pan Grid Oven Front Frame	Chrome Plating	Removable plated parts may be soaked in ammonia solution of 1 cup ammonia to 2 gallons of water.
Porcelain Door Panel	Porcelain Enamel	Detergent and hot water. Rinse and dry with soft cloth.
Satin Chrome Door Panel	Chrome Plating	Soap and hot water. Rinse and dry with soft cloth. Mild glass cleaner will remove fingermarks.
Glass in Door and Control Panel	Glass	Detergent and hot water. Mild glass cleaner.
Control Frame	Chrome Plating	Detergent and hot water. Mild glass cleaner will remove fingermarks.
Control Knobs	Plated Plastic	Detergent and hot water
Oven Interior	Pyrolytic Porcelain Enamel	See Self-Cleaning Section (Pages 27-29).
Meat Probe		Wet cloth with detergent. DO NOT immerse probe in water.

OVEN DOOR REMOVAL

Removing the oven door.

Use caution as oven doors are heavy.

1. Open door completely.
2. Depress finger tab in oven door hinge area, push tab toward oven. Lift tab away from door lining and slide toward top of oven door.
3. Repeat step 2 on opposite side of door.
4. Close door to stop position (door will be open 6 inches).
5. Lift the door off the hinge arm assemblies.

Replace door by using the opposite procedure.

1. Replace door on hinge arm assemblies.
2. Open door completely.
3. Push finger tabs toward oven. Depress the tabs and slide toward top of door.
4. Close and open the door slowly to make sure it is replaced properly.

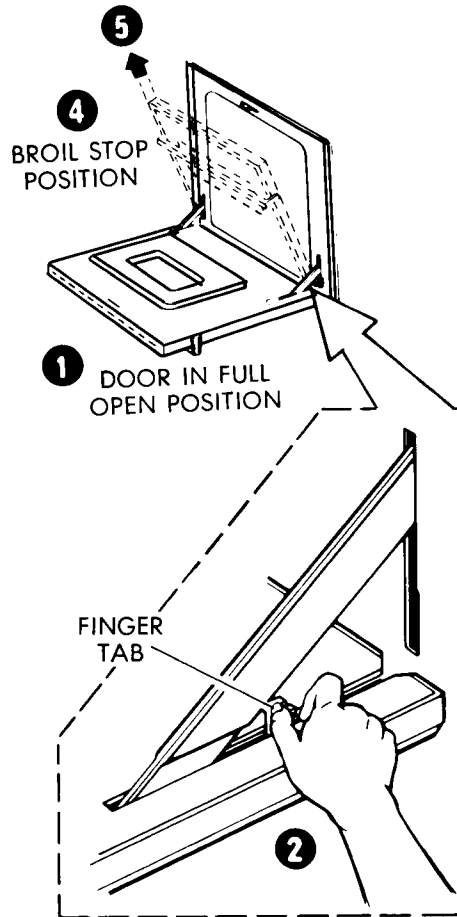

BEFORE STARTING THE SELF-CLEAN CYCLE

The self-clean feature is designed to eliminate the need for scrubbing and scouring soil baked onto oven interior. Food spatters on the oven walls become harder to remove each time the oven is heated (170°-550°F.). The self-clean cycle heats these soils to a higher temperature (850°-900°F.), where soil is "burned-off."

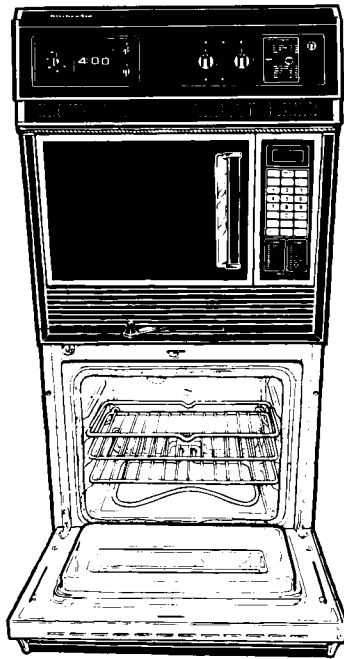

CAUTION:

Never use chemical oven cleaners inside self-cleaning oven or on the raised portion of the door.

IMPORTANT:

Do not clean the broiler pan, broiler grid or cooking utensils in the oven. Heavy grease build up on these items will produce smoke and odors which can be discharged into the kitchen area.

1. Remove all articles from the oven.

The oven racks may be left in the oven during a clean cycle, but will be discolored and darkened by each additional cleaning, thus it is recommended that the racks be removed. If oven racks remained in the oven during the clean cycle, wipe the sides with a small amount of vegetable oil, to make the racks slide easily.

To remove oven rack (See illustration on Page 9)

Slide rack forward until bar on back of rack touches first stop. Lift front of rack until rear portion of rack slides out between front two stops.

2. Wipe up large spillovers.

The smoke eliminator will handle the normal flow of odors, but when there is heavy soil, minor smoke may be noticed.

3. Wipe soil from oven frame and door outside of gasket.

These areas are not cleaned during cleaning cycle. Use detergent and hot water or a non-scratch scouring pad, and rinse well with a mixture of vinegar and water. Wash surfaces frequently to minimize over-all cleaning. To retain the original appearance, rinse and wipe surfaces dry after washing.

CAUTION:

DO NOT scrub or clean oven door or gasket.

4. Check to see that the rotisserie and meat probe jack covers are down.

TO START THE SELF-CLEAN CYCLE

(Single/Upper Oven Only)

Check

- Previous page "Before Starting the Self-Clean Cycle."
- That the **clock** and the **start time control** are set for the correct time of day.
NOTE that the **start time control** will be in a "popped out" position when the **start time control** is the same as the time of day.

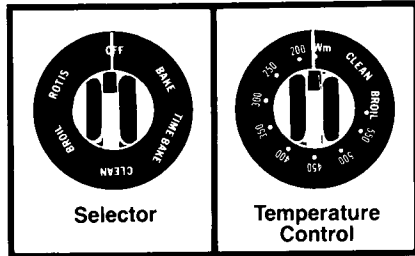

Oven Self-Cleaning Tips

- A good time to self-clean the oven is in the evening, when normal oven use is completed.
- It is normal to notice a slight amount of smoke escaping around the oven vent during self-cleaning when soil is heavy. **Excessive** smoke may indicate heavy spillovers have not been wiped up.
- The oven should be cleaned before it becomes "excessively dirty." If the oven is not clean after one cycle, repeat cleaning cycle.
- Do NOT attempt to force the clean latch lever when the **lock** light is on. This could cause damage to the latch mechanism.

1. Close door.
2. Push in and turn **stop time control** (4) ahead to the hour you want the cleaning to stop.

From the following chart determine the length of clean time needed.

CLEAN TIME CHART	Soil	Set Stop Time
	Description	Ahead
	Moderate Soil	2 hrs.
	Heavy Soil	3 hrs.

3. Set both **selector** and **temperature control** to "CLEAN."
4. Slide **clean latch lever** located below microwave oven door all the way to the right. There will be a sharp click as lever is moved to the right. Upon completion of these steps the clean cycle will begin.

NOTE: The clean cycle can be set to come on at a later time automatically if desired. Set the "start time" to the desired "start time" and the "stop time" to the desired "stop time."
The microwave oven will not operate when the lower oven is being cleaned.

OVEN SELF-CLEANING

(Single/Upper Oven only)

What Happens During the Self-Clean Cycle

After the controls are set:

- The **oven and clean lights** will glow to tell you the oven is slowly heating to the clean temperature.
- The **lock light** will come on when the temperature reaches 575°-600°F (approximately 15 minutes).

At the End of the Cleaning Cycle

- The **oven light** will go out.
- The **clean light** will stay on.
- The **lock light** will continue to glow until the oven temperature drops below 550°F (approximately 45 minutes). The oven door cannot be opened until **lock light** goes out.
- After a clean cycle any powdery residue can be wiped away with a damp cloth. If white spots remain in the oven after a clean cycle, remove them with a non-scratch scouring pad before using the oven again. These spots are usually salt residues that cannot be removed during the Self-Clean action.
- If the soil removal was not complete, simply increase the length of the clean time in the next cycle.

To return oven to regular use

1. Slide **clean latch lever** all the way to the left.
2. Turn **selector** to "OFF" and **temperature control** to maximum left position. **NOTE:** Do not reverse order of these steps, since turning either control to "OFF" will not allow the door to be opened.
3. Allow oven to cool.

To interrupt cleaning cycle before lock light comes on:

1. Turn **stop time control** until it pops out.
2. Slide **clean latch lever** all the way to the left.
3. Turn **selector** to "OFF" and **temperature control** to maximum left position. See note above about changing order of operation.

After lock light comes on:

1. Turn **stop time control** until it pops out.
2. Wait for **lock light** to go out.
3. Slide **clean latch lever** all the way to the left. See note under to return oven to regular use.
4. Allow oven to cool.

REMEMBER:

Oven door cannot be unlocked while **lock light** is on.

SPECIAL INFORMATION

To replace oven light bulb(s)

- **CAUTION**— Make sure oven is cool before starting.
- Remove three screws in lens holder. (This requires the use of a Phillips screwdriver.)
- Lift holder, glass lens and gasket out.
- Unscrew oven light bulb and replace with a 40 watt appliance bulb.
- Replace gasket, lens and holder, and tighten screws.



To replace panel light bulb

- Disconnect the power at the fuse box before changing the light bulb.
- On oven light and panel light switch, remove bezel nut by turning counter-clockwise.
- Remove all other knobs by pulling straight forward.
- Remove the Phillips screw under the lock lever knob to remove knob off the lock lever.
- Remove the front 3 Phillips screws under the control frame and the 2 Phillips screws located on the top por-

tion of the control frame being careful to hold the control frame in place.

- Pull control frame forward.
- Remove the bulb by twisting and sliding forward.
- Replace used bulb with a GE F8T5 (8 watt) bulb (or equivalent) by sliding in and twisting 90°.
- Replace control frame, screws and knob. Turn on the power. Remember to correct the time of day on your clock.

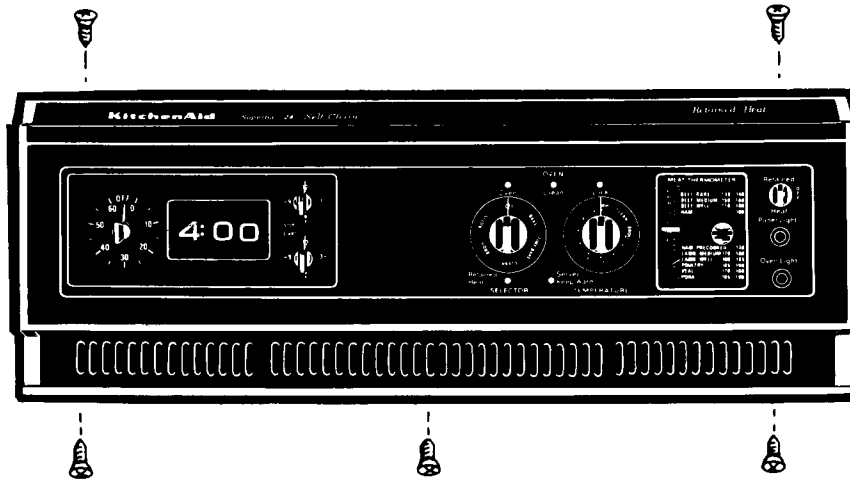

WHEN YOU NEED SERVICE

Follow These Steps

1. If your oven should fail to operate, review the following list before calling your dealer. You could save the cost of a service call.
 - Have instructions in this book been followed?
 - Has a fuse blown, or is the circuit breaker open?
 - Is the selector set in correct position?
 - Recheck suspected defect.
2. If the problem is not due to one of the above items, see "How to Arrange For Service" listed in the Warranty Statement.
3. If you are not satisfied with the action taken, contact the Major Appliance

Consumer Action Panel (MACAP). MACAP is a group of independent consumer experts that voices consumer views at the highest levels of the major appliance industry. Contact them only when the dealer, authorized servicing outlet, and KitchenAid, Inc. have failed to resolve your problem.

**Major Appliance Consumer
Action Panel**
20 North Wacker Drive
Chicago, IL 60606

MACAP will in turn inform us of your action.

In all correspondence about your oven, please include:

- Date
- Your Name, Address, and Telephone Number
- Type of Appliance
- Brand
- Model Number
- Serial Number
- Date Purchased
- Dealer from Which Purchased (include address)
- Servicing Agent (include name and address if different from dealer)
- Location of Appliance
- A Clear Description of the Problem and the Service Required

KitchenAid COOKING PRODUCTS WARRANTY

LENGTH OF WARRANTY:	KITCHENAID WILL PAY FOR:	KITCHENAID WILL NOT PAY FOR:
ONE YEAR FULL WARRANTY FROM DATE OF INSTALLATION.	Replacement parts and repair labor to correct defects in materials or workmanship. Service must be provided by an authorized KitchenAid servicing outlet.	A. Service calls to: 1. Correct the installation of the cooking product. 2. Instruct you how to use the cooking products. 3. Replace house fuses or correct house wiring.
FIVE YEAR LIMITED WARRANTY ONE YEAR FULL PLUS SECOND THROUGH FIFTH YEAR LIMITED FROM DATE OF INSTALLATION.	Replacement parts for any electric element on electric models or any burner on gas models if defective in materials or workmanship. Replacement part for the magnetron tube in the combination microwave/single wall oven if defective in materials or workmanship.	B. Repairs when cooking product is used in other than normal home use. C. Damage resulting from accident, alteration, misuse, abuse, improper installation or installation not in accordance with local electrical.
TEN YEAR LIMITED WARRANTY ONE YEAR FULL PLUS SECOND THROUGH TENTH YEAR LIMITED FROM DATE OF INSTALLATION.	Replacement of the porcelain oven cavity/inner door if the part rusts through due to defective materials or workmanship.	D. Any labor costs during limited warranty. E. Replacement parts or repair labor costs for units operated outside the United States. F. Pick up and delivery. This product is designed to be repaired in the home.

KITCHENAID, INC. DOES NOT ASSUME ANY RESPONSIBILITY FOR INCIDENTAL OR CONSEQUENTIAL DAMAGES. Some states do not allow the exclusion or limitation of incidental or consequential damages, so this exclusion or limitation may not apply to you.

This warranty gives you specific legal rights and you may also have other rights which vary from state to state.

HOW TO ARRANGE FOR SERVICE

- First call your dealer or repair service he recommends.
- All service should be handled locally by the dealer from whom you purchased the unit or an authorized KitchenAid servicing outlet. If your local service is not satisfactory, contact the Consumer Affairs Department, KitchenAid, Inc., P.O. Box 558, St. Joseph, Michigan 49085-0558. Call Toll Free: 800-422-1230.

KitchenAid, Inc.
St. Joseph, Michigan, USA 49085

Free Manuals Download Website

<http://myh66.com>

<http://usermanuals.us>

<http://www.somanuals.com>

<http://www.4manuals.cc>

<http://www.manual-lib.com>

<http://www.404manual.com>

<http://www.luxmanual.com>

<http://aubethermostatmanual.com>

Golf course search by state

<http://golfingnear.com>

Email search by domain

<http://emailbydomain.com>

Auto manuals search

<http://auto.somanuals.com>

TV manuals search

<http://tv.somanuals.com>