

Model  
KHMS147H

# USE & CARE GUIDE

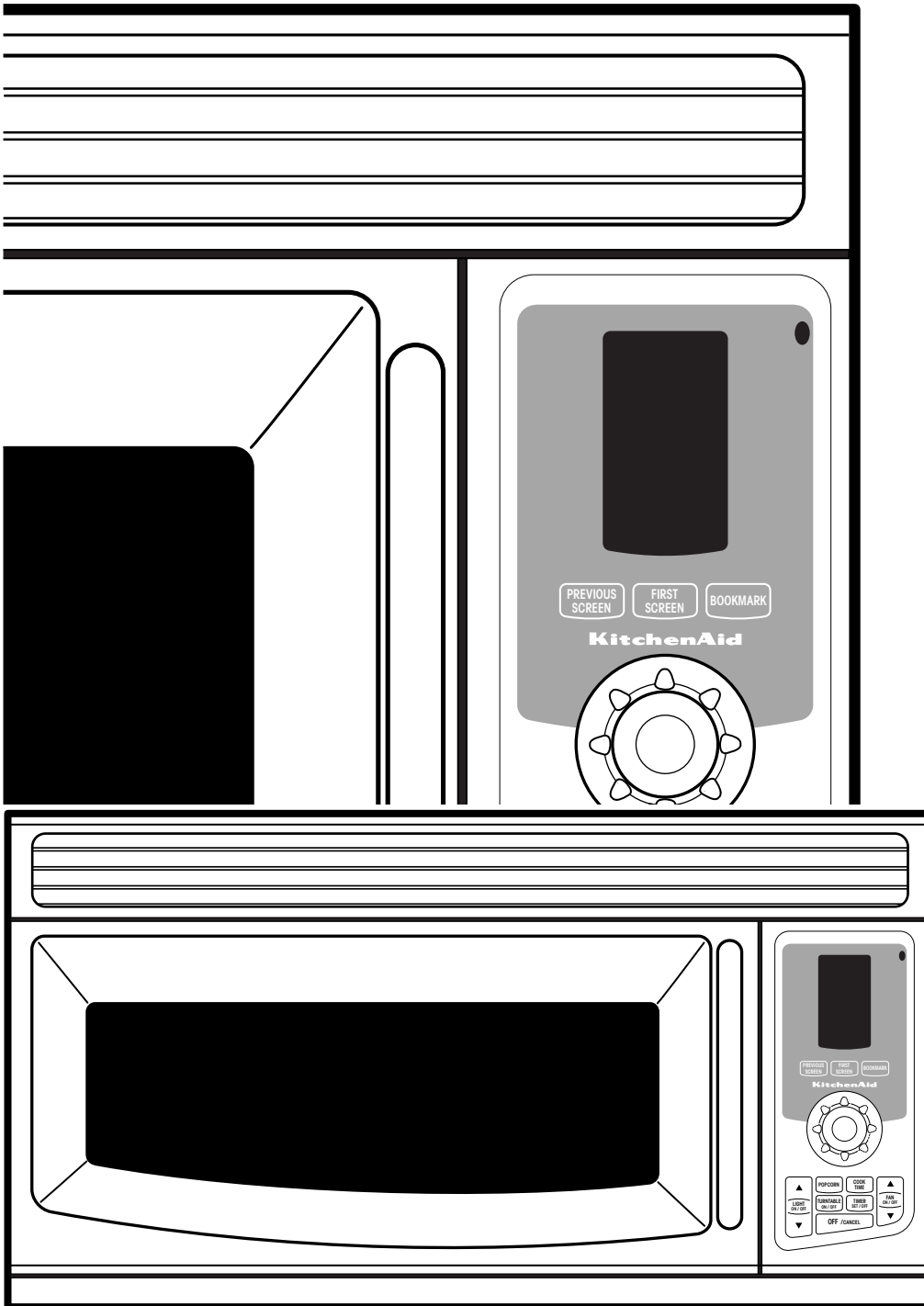

**KitchenAid®**

## Microwave Hood Combination

A Note to You .....	2
Microwave Oven Safety.....	3
Installation Instructions .....	6
Getting to Know Your Microwave Oven.....	7
Using Your Microwave Oven...10	
Understanding your new MICRO-DIAL™ microwave oven.....	10
How to use your new MICRO-DIAL control.....	10
Function Example--Cook .....	11
Using Hints .....	12
Using Demo Mode.....	12
Using Learning Mode .....	12
Setting the Clock .....	13
Using the Child Lock .....	13
Audible Signals.....	14
Using Bookmark .....	14
Using the Minute Timer .....	15
Understanding "Doneness" Control .....	15
Understanding Sensor Cooking.....	15
Using Reheat.....	15
Manual Cooking at variable powers .....	16
Manual Cooking in stages .....	17
Using Defrost.....	17
Using Pan Brown.....	18
Using EASY SIMMER .....	19
Using 2-4 Plates .....	20
Using the Exhaust Fan .....	20
Using the Cooktop Light .....	21
Using the cooking rack .....	21
Caring for Your Microwave Oven .....	22
Questions and Answers .....	24
Troubleshooting .....	25
Requesting Assistance or Service.....	27
Warranty.....	28

4619-652-59223/8183746

[www.kitchenaid.com](http://www.kitchenaid.com)

**1•800•422•1230**

Call our Customer  
Interaction Center with  
questions or comments.

# A NOTE TO YOU

## Thank you for buying a KITCHENAID® appliance!

KitchenAid designs the best tools for the most important room in your house, your kitchen. To ensure that you enjoy many years of trouble-free operation, we developed this Use and Care Guide. It contains valuable information concerning how to operate and maintain your new appliance properly. Please read it carefully.

**Also, please complete and mail the enclosed Product Registration Card.**

## For assistance or service

Call the Customer Interaction Center toll free ..... **1-800-422-1230**

If you need assistance or service, first see the "Troubleshooting" section of this book. After checking "Troubleshooting," additional help can be found by checking the "Requesting Assistance or Service" section, or by calling the telephone number above.

When calling, you will need to know your appliance's complete model number and serial number. You can find this information on the model and serial number label/plate (see diagram in the "Getting to Know" section.)

Keep this book and the sales slip together for future reference. **You must provide proof of purchase or installation date for in-warranty service.**

<b>Model Number</b> _____	<b>Builder/Dealer Name</b> _____
<b>Serial Number</b> _____	<b>Address</b> _____
<b>Date Installed</b> _____	<b>Phone</b> _____

# MICROWAVE OVEN SAFETY

## Your safety and the safety of others are very important.

We have provided many important safety messages in this manual and on your appliance. Always read and obey all safety messages.



This is the safety alert symbol.

This symbol alerts you to potential hazards that can kill or hurt you and others.

All safety messages will follow the safety alert symbol and either the word "DANGER" or "WARNING." These words mean:

**⚠ DANGER**

**You can be killed or seriously injured if you don't immediately follow instructions.**

**⚠ WARNING**

**You can be killed or seriously injured if you don't follow instructions.**

All safety messages will tell you what the potential hazard is, tell you how to reduce the chance of injury, and tell you what can happen if the instructions are not followed.

## IMPORTANT SAFETY INSTRUCTIONS

When using electrical appliances basic safety precautions should be followed, including the following:

**WARNING:** To reduce the risk of burns, electric shock, fire, injury to persons, or exposure to excessive microwave energy:

- Read all instructions before using the microwave oven.
- Read and follow the specific "PRECAUTIONS TO AVOID POSSIBLE EXPOSURE TO EXCESSIVE MICROWAVE ENERGY" found in this section.
- The microwave oven must be grounded. Connect only to properly grounded outlet. See "GROUNDING INSTRUCTIONS" found in this section and in the provided installation instructions.
- Install or locate the microwave oven only in accordance with the provided Installation Instructions.
- Some products such as whole eggs in the shell and sealed containers – for example, closed glass jars – may explode and should not be heated in the microwave oven.
- Use the microwave oven only for its intended use as described in this manual. Do not use corrosive chemicals or vapors in the microwave oven. This type of oven is specifically designed to heat, cook, or dry food. It is not designed for industrial or laboratory use.
- As with any appliance, close supervision is necessary when used by children.
- Do not operate the microwave oven if it has a damaged cord or plug, if it is not working properly, or if it has been damaged or dropped.
- The microwave oven should be serviced only by qualified service personnel. Call an authorized service company for examination, repair, or adjustment.
- To reduce the risk of fire in the oven cavity:
  - Do not overcook food. Carefully attend the microwave oven if paper, plastic, or other combustible materials are placed inside the oven to facilitate cooking.
  - Remove wire twist-ties from paper or plastic bags before placing bags in oven.
  - If materials inside the oven should ignite, keep oven door closed, turn oven off, and disconnect the power cord, or shut off power at the fuse or circuit breaker panel.
  - Do not use the cavity for storage purposes. Do not leave paper products, cooking utensils, or food in the cavity when not in use.
- Suitable for use above both gas and electric cooking equipment.
- Intended to be used above ranges with maximum width of 36 inches.

**SAVE THESE INSTRUCTIONS**

continued on next page

# MICROWAVE OVEN SAFETY

## IMPORTANT SAFETY INSTRUCTIONS

- Clean Ventilating Hoods Frequently - Grease should not be allowed to accumulate on hood or filter.
- Oversized foods or oversized metal utensils should not be inserted in the microwave oven as they may create a fire or risk of electric shock.
- Do not clean with metal scouring pads. Pieces can burn off the pad and touch electrical parts involving a risk of electric shock.
- Do not use paper products when appliance is operated in the "PAN BROWN" mode.
- Do not store any materials other than manufacturer's recommended accessories in this oven when not in use.
- Do not store anything directly on top of the microwave oven when the microwave oven is in operation.
- When flaming foods under the hood, turn the fan on.
- Use care when cleaning the vent-hood filter. Corrosive cleaning agents, such as lye-based oven cleaners, may damage the filter.
- Do not cover or block any openings on the microwave oven.
- Do not store this microwave oven outdoors. Do not use the microwave oven near water – for example, near a kitchen sink, in a wet basement, or near a swimming pool, and the like.
- Do not immerse cord or plug in water.
- Keep cord away from heated surfaces.
- Do not let cord hang over edge of table or counter.
- Do not mount over a sink.
- Do not cover racks or any other part of the oven with metal foil. This will cause overheating of the oven.
- See door surface cleaning instructions in the "Hints" section of the MICRO-DIAL™ control.

## SAVE THESE INSTRUCTIONS

## PRECAUTIONS TO AVOID POSSIBLE EXPOSURE TO EXCESSIVE MICROWAVE ENERGY

- (a) Do not attempt to operate this oven with the door open since open-door operation can result in harmful exposure to microwave energy. It is important not to defeat or tamper with the safety interlocks.
- (b) Do not place any object between the oven front face and the door or allow soil or cleaner residue to accumulate on sealing surfaces.
- (c) Do not operate the oven if it is damaged. It is particularly important that the oven door close properly and that there is no damage to the:
  - (1) Door (bent),
  - (2) Hinges and latches (broken or loosened),
  - (3) Door seals and sealing surfaces.
- (d) The oven should not be adjusted or repaired by anyone except properly qualified service personnel.

# MICROWAVE OVEN SAFETY

## Electrical requirements

Observe all governing codes and ordinances. A 120 Volt, 60 Hz, AC only, 15 or 20 amp fused electrical supply is required. (A time-delay fuse is recommended.) It is recommended that a separate circuit serving only this appliance be provided.

### **⚠ WARNING**



#### **Electrical Shock Hazard**

**Plug into a grounded 3 prong outlet.**

**Do not remove ground prong.**

**Do not use an adapter.**

**Do not use an extension cord.**

**Failure to follow these instructions can result in death, fire, or electrical shock.**

## GROUNDING INSTRUCTIONS

### • **For all cord connected appliances:**

The microwave oven must be grounded. In the event of an electrical short circuit, grounding reduces the risk of electric shock by providing an escape wire for the electric current. The microwave oven is equipped with a cord having a grounding wire with a grounding plug. The plug must be plugged into an outlet that is properly installed and grounded.

**WARNING:** Improper use of the grounding plug can result in a risk of electric shock.

Consult a qualified electrician or serviceman if the grounding instructions are not completely understood, or if doubt exists as to whether the microwave oven is properly grounded.

Do not use an extension cord. If the power supply cord is too short, have a qualified electrician or serviceman install an outlet near the microwave oven.

### • **For a permanently connected appliance:**

The microwave oven must be connected to a grounded, metallic, permanent wiring system, or an equipment grounding conductor should be run with the circuit conductors and connected to the equipment grounding terminal or lead on the microwave oven.

# INSTALLATION INSTRUCTIONS

## Removing and replacing the microwave oven

### **⚠ WARNING**

#### **Excessive Weight Hazard**

**Use two or more people to move and install microwave oven.**

**Failure to do so can result in back or other injury.**

If you need to remove your Microwave Hood Combination for any reason, follow these simple steps:

### To remove:

1. Unplug microwave oven or disconnect power.
2. Remove filters and vent grille.

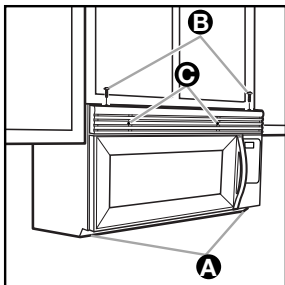

- If filters **A** are installed, push in at the tab and slide filter to the outside edge to remove.

- Remove the two screws **B** from the top of the microwave oven cabinet (the screws located closest to the front corners). Do not remove

the screws located towards the center of the cabinet.

- Remove the vent grille **C**. Set the screws and grille aside. (If grille cannot be removed, see pt. 4.)

3. After removing all oven contents, including the turntable and support, tape the door in the closed position. Then remove the two bolts **D** securing the microwave oven to the upper cabinet.

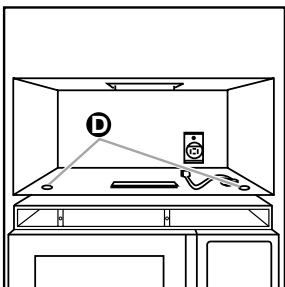

4. Hold microwave hood combination in place with one hand. Pull hook **E** to release microwave hood from mounting plate. If grille cannot be removed (per instructions in pt. 2), insert a thin looped wire or similar tool through an opening in grille to pull hook.

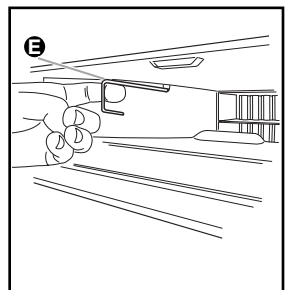

5. Grasp the microwave oven. Rotate the microwave oven downward. (Be careful that door does not swing open.)

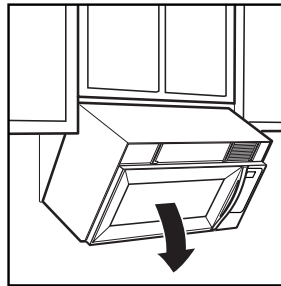

6. Lift off the support tabs **F** at the bottom of the mounting plate. Set the microwave oven aside on a protected surface.



### To replace:

1. Carefully lift microwave oven and hang it on the support tabs at the bottom of the mounting plate.
2. Rotate the front of the microwave oven cabinet downward. Thread the power supply cord through the power supply cord hole in the bottom of the upper cabinet.
3. Rotate the microwave oven towards the cabinet. Push the microwave oven against the mounting plate until locking latch snaps into the cabinet.
4. Replace the two bolts securing the microwave oven to the upper cabinet.
5. Untape the door and replace the turntable and support.
6. Replace the vent grille.
7. Replace the two screws in the top of microwave oven cabinet (the screws located closest to front corners).
8. If filters were installed, replace them (see "Installing and caring for the filters" in the "Caring for Your Microwave Oven" section, if needed).
9. Plug in microwave oven or reconnect power.

# GETTING TO KNOW YOUR MICROWAVE OVEN

This section discusses the concepts behind microwave cooking. It also shows you the basics you need to know to operate your microwave oven. Please read this information before you use your oven.

## Operating tips

- **Never** lean on the door or allow a child to swing on it when the door is open.
- **Use hot pads.** Microwave energy does not heat containers, but the heat from the food can make the container hot.
- **Do not** use newspaper or other printed paper in the oven.
- **Do not** dry flowers, fruit, herbs, wood, paper, gourds, or clothes in the oven.
- **Do not** start a microwave oven when it is empty. Product life may be shortened. If you practice programming the oven, **put** a container of water in the oven. It is normal for the oven door to look wavy after the oven has been running for a while.
- **Do not** try to melt paraffin wax in the oven. Paraffin wax will not melt in a microwave oven because it allows microwaves to pass through it.
- **Do not** operate the microwave oven unless the glass turntable is securely in place and can rotate freely. The turntable can rotate in either direction. **Make sure** the turntable is correct-side up in the oven. **Handle your turntable with care** when removing it from the oven to avoid possibly breaking it. If your turntable cracks or breaks, contact your dealer for a replacement.
- **When you use a browning dish**, the browning dish bottom must be at least  $\frac{3}{16}$  in. (5.5 mm) above the turntable. Follow the directions supplied with the browning dish.
- **Never cook or reheat a whole egg inside the shell.** Steam buildup in whole eggs may cause them to burst, and possibly damage the oven. **Slice** hard-boiled eggs before heating. In rare cases, poached eggs have been known to explode. **Cover** poached eggs and **allow** a standing time of one minute before cutting into them.
- **For best results, stir any liquid several times during heating or reheating.** Liquids heated in certain containers (especially containers shaped like cylinders) may become overheated. The liquid may splash out with a loud noise during or after heating when stirring or when adding ingredients (coffee granules, tea bags, etc.). This can harm the oven.
- **Microwaves** may not reach the center of a roast. The heat spreads to the center from the outer, cooked areas just as in regular oven cooking. This is one of the reasons for letting some foods (for example, roasts or baked potatoes) stand for a while after cooking, or for stirring some foods during the cooking time.
- **Do not deep fry in the oven.** Microwavable utensils are not suitable and it is difficult to maintain appropriate deep-frying temperatures.
- **Do not overcook potatoes.** At the end of the recommended cooking time, potatoes should be slightly firm because they will continue cooking during standing time. **After microwaving, let** potatoes stand for 5 minutes. They will finish cooking while standing.

## Electrical connection

**If your electric power line or outlet voltage** is less than 110 volts, cooking times may be longer. Have a qualified electrician check your electrical system.

# GETTING TO KNOW YOUR MICROWAVE OVEN

## Microwave oven features

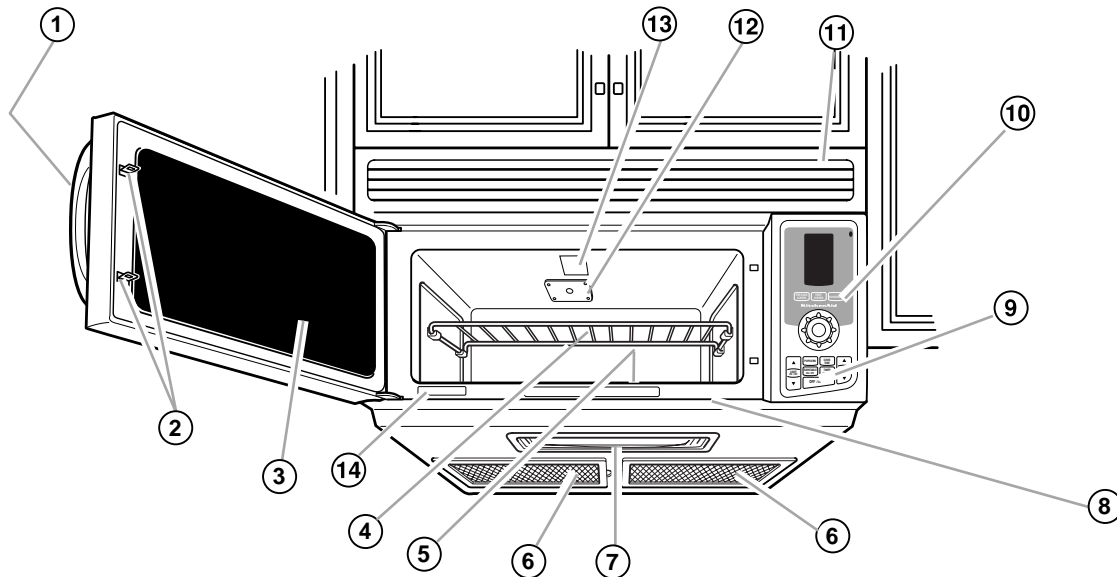

Your microwave oven is designed to make your cooking experience as enjoyable and productive as possible. To help get you up and running quickly, the following is a list of the oven's basic features:

- 1. Door Handle.** Pull to open door.
- 2. Door Safety Lock System.** The oven will not operate unless the door is securely closed.
- 3. Window with Metal Shield.** Shield prevents microwaves from escaping. It is designed as a screen to allow you to view food as it cooks.
- 4. Cooking Rack.** Use for extra space when cooking in more than one container at the same time (See Page 21).
- 5. Glass Turntable (PN 4393751) (not shown).** Included in oven cavity – see below for installation instructions. This turntable rotates food as it cooks for more even cooking. It must be in the oven during operation for best cooking results. The turntable is sunken into the cavity floor to give you more cooking space and better cooking results.
- 6. Charcoal and Grease Filters.** Packed in oven cavity during shipment.
- 7. Cooktop/Countertop Light.** Turn on to light your cooktop or countertop or turn on as a night light.
- 8. Cooking Guide Label.** Use as a quick reference for various oven functions.
- 9. Exhaust Fan and Cooktop Light Pads.**
- 10. Control Panel.** Touch the pads or operate the MICRO-DIAL™ Control on this panel to perform all functions.
- 11. Vent Grille.**
- 12. Microwave Inlet Cover.** Do not remove or disturb.
- 13. Oven Cavity Light.**
- 14. Model and Serial Number Plate.**

### To install turntable and support:

- Remove tape holding the hub (PN 4393754) in place.
  - Place the support (PN 4393752) on the cavity bottom.
  - Place the turntable on the hub. Make sure the raised, curved lines in the center of the turntable bottom are between the three "spokes" of the hub.
- The rollers (PN 4393753) on the support should fit inside the ridge on the bottom of the turntable.
- The turntable turns both clockwise and counter-clockwise. This is normal.

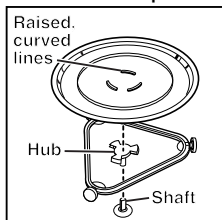

### Crisper pan:

This specially-designed microwave pan (PN 4393536) lets you cook crispy pizza, sizzle chicken, fry breakfast foods like eggs and sausage, or prepare juicy hamburgers. See the "Pan Brown" section on in your MICRO-DIAL control display.

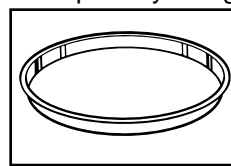



# GETTING TO KNOW YOUR MICROWAVE OVEN

## Control panel features

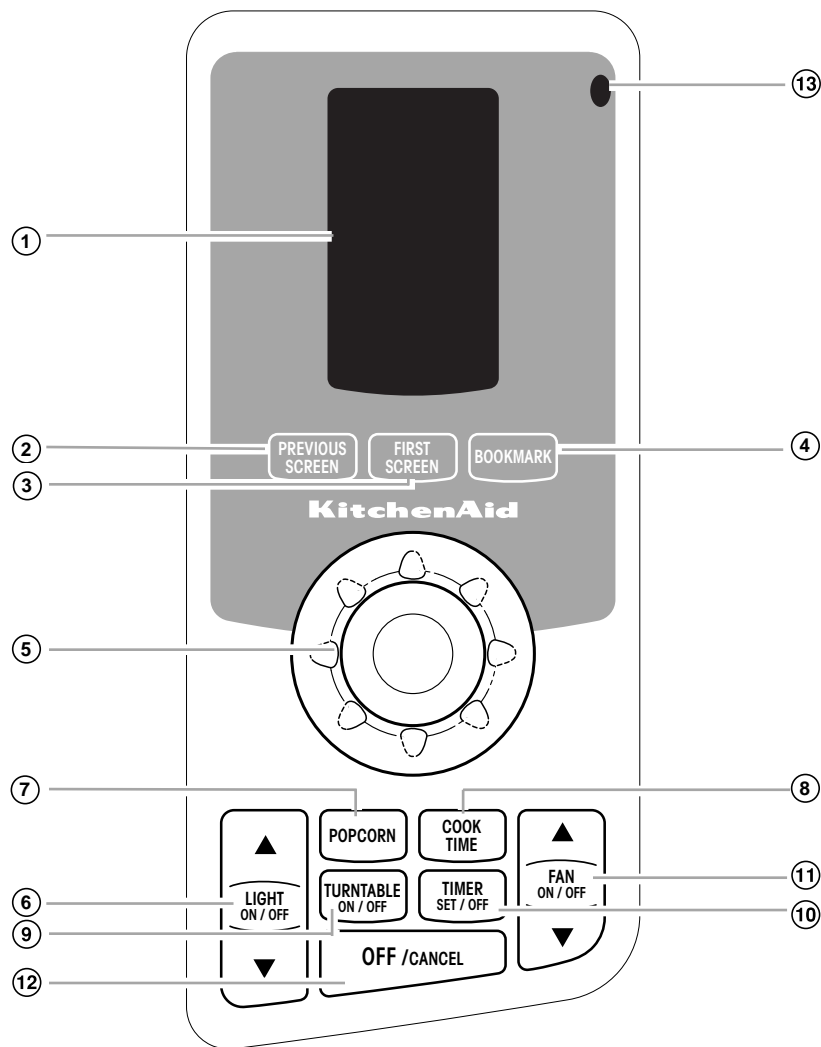

- 1. Display Screen** shows the time of day and First Screen when the microwave oven is not in use. During programming, it displays function menus for you to choose from, servings and weights for you to enter, preparation instructions, and cooking time/power settings for you to select. During a cooking cycle, it counts down the remaining time and prompts you to stir, turn food, etc., as necessary.
- 2. PREVIOUS SCREEN.** Touch this pad to turn back a page.
- 3. FIRST SCREEN.** Touch this pad to reset display to the first page.
- 4. BOOKMARK.** Touch this pad to choose and store and recall favorite programs, see page 14.
- 5. MICRO-DIAL™ Control.** Use this control to select oven functions, such as quantities of food and cooking times/powers.
- 6. LIGHT ON/OFF.** Touch this pad to switch the cook-top light on and off. Touch up or down arrows to control brightness.
- 7. POPCORN.** Touch this pad to make perfect microwave popcorn automatically.
- 8. COOK TIME.** Touch this pad for manual control of cook time and power.
- 9. TURNTABLE ON/OFF.** Touch this pad to turn the turntable on or off.
- 10. TIMER SET/OFF.** Touch this pad to set or cancel the minute timer.
- 11. FAN ON/OFF.** Touch this pad to start or stop the hood vent fan. Touch up or down arrows to control fan speed.
- 12. OFF/CANCEL.** Touch this pad to stop or cancel any microwave function.
- 13. Night Light Sensor** turns on Night Light when it detects a low light level, see page 21.

# USING YOUR MICROWAVE OVEN

## Understanding your new MICRO-DIAL™ microwave oven



It's as EZ as 1, 2, 3! This microwave has a special pan that can brown and fry foods. Now you can cook fun foods like... Crispy Pizza... foods like juicy hamburgers or breakfast sausage and eggs. Cook rice and pasta to perfection using the Easy Simmer. Please open the door and look inside. Halogen lighting makes seeing inside better than ever. Enjoy the quietness of the exhaust hood. You can even choose from 5 fan speeds. A learning mode found under Custom Menu Selection makes exploring fun. Features can be tried without turning the Microwave on.

## How to use your new MICRO-DIAL Control

**Faster, easier, better than ever before--** that's microwave cooking with the new MICRO-DIAL control. Just watch the display screen and choose what you want from the menus.

### Turn MICRO-DIAL control:

- To select a function.
- To set cook time.
- To set cook power.
- To set the clock.
- To set Minute Timer.

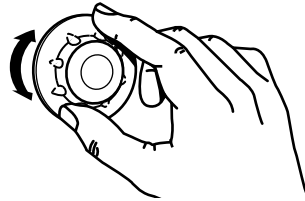

### Press MICRO-DIAL control:

- Enter a selection.
- To see Next Page.
- To start cooking.

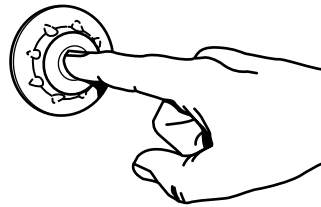

### Touch FIRST SCREEN pad:

- To start over.

### Touch OFF/CANCEL pad:

- To stop any microwave function.

## Function Selections

### COOK

Choices include:  
Cereals  
Eggs  
Fish  
Frozen - Fast Food  
Grains - Rice/Pasta  
Meat  
Poultry  
Vegetables  
Manual

### REHEAT

Choices are:  
One Plate  
2-4 Plates  
Beverage  
Casserole  
Roll  
Muffin  
Pizza  
Sauce  
Soup  
Manual

### DEFROST

Choose from:  
Meat  
Poultry  
Fish  
Manual

### PAN BROWN

Menu offers:  
Coconut  
Eggs, Fried  
Omelet  
French Toast  
Ham Steak  
Hamburger  
Hash Browns  
Meatballs  
Nuts, Toasted  
Pizza  
Poultry, Breast  
Sausage  
Sesame Seeds  
Manual

### EASY SIMMER

Selections are:  
Rice  
Pasta  
Boil & Simmer  
**2-4 PLATES**  
Select reheat for 2, 3, or 4 Plates

### HINTS

Offers helpful advice about:  
Cleaning  
Power  
Food  
Techniques  
Utensils

### CUSTOM

Menu includes:  
Child Lock  
Set Clock  
Nite Lite  
Signals  
Demo Mode  
Display Contrast  
Learning Mode

### BOOKMARK

Touchpad lets you choose favorite cooking programs, store them in memory and recall them whenever you want

# USING YOUR MICROWAVE OVEN

## Function Example – Cook

The MICRO-DIAL™ control leads you quickly and easily through the choices about what you're cooking, then automatically sets the right cook power and cook time. To see how easy it is, follow this example about preparing servings of instant cereal.

**NOTE:** The example used is merely an explanation of the function. The actual values and entries are subject to change by KitchenAid to improve cooking performance.

TOUCH FIRST SCREEN pad, TURN to select Cook and PRESS.

TURN to select Cereals and PRESS.

TURN to select Instant All Cereals and PRESS.

TURN to select 3 servings and PRESS.

If you already know how to prepare food, TURN to select START and PRESS, to skip following steps. Or, TURN to select Prepare and PRESS.

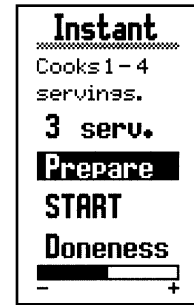
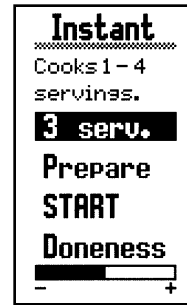
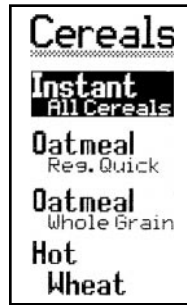
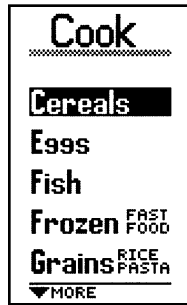
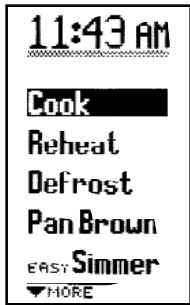

Follow directions and PRESS.

TURN to select "Doneness" (see p. 15) and PRESS. TURN to adjust, and PRESS.

TURN to Start and PRESS. Clock will count down cooking time.

WAIT for tones that signal the end of cooking time.

No matter which function you select, its program gets you cooking in a hurry! If you'd like to practice before you actually start microwave cooking, see "Using Learning Mode" section.

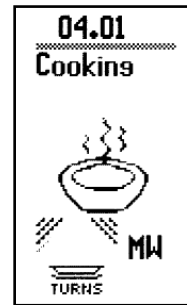
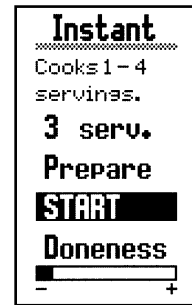
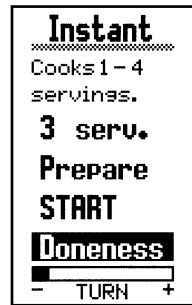
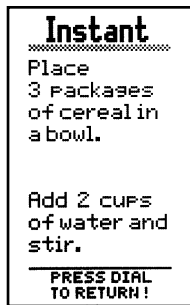

# USING YOUR MICROWAVE OVEN

## Using Hints

This section offers helpful information and suggestions about using and caring for your microwave hood combination.

This example follows Hints about Cleaning, starting with the First Screen.

TOUCH FIRST SCREEN pad, TURN to select Hints and PRESS.

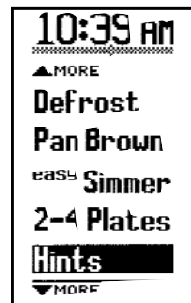

TURN to select Cleaning and PRESS.

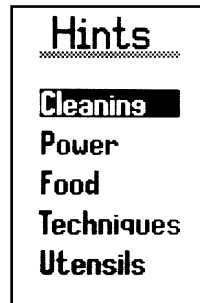

TURN to select Odors and PRESS.



Follow instructions on screen.

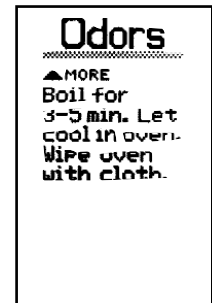
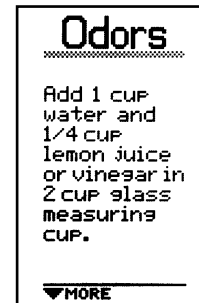

## Using Demo Mode

This program demonstrates the features and capabilities of your microwave hood combination featuring the MICRO-DIAL™ System. Microwave cooking simply doesn't get any quicker, easier or better.

TOUCH FIRST SCREEN pad, TURN to select Custom and PRESS.

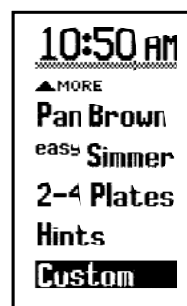

TURN to select Demo Mode and PRESS.



PRESS to activate Demo Mode.



## Using Learning Mode

This program lets you practice using the MICRO-DIAL Control. It enters every programming step with real displays and tones *without* turning on the microwave power.

**NOTE:** When finished, repeat turning control left to select Off.

TOUCH FIRST SCREEN pad, TURN to select Custom and PRESS.

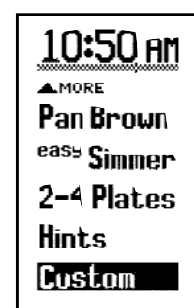

TURN to select Learning Mode and PRESS.

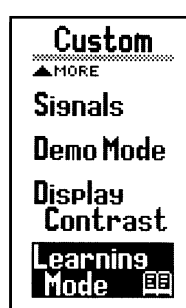

TURN to select On and PRESS.

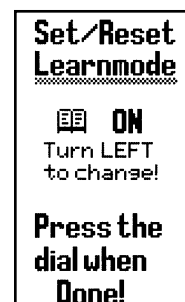

TURN to select function and PRESS.

**NOTE:** The "book" icon (shown above) will appear at various times during the Learning Mode function to indicate that the oven is operating *without* microwave power.

## Setting the Clock

When your microwave oven is first plugged in, or after a power failure, the "Welcome" screen will appear.

### NOTES:

- To turn off the clock, select Set Clock and touch OFF/CANCEL. The clock continues to keep the correct time when the display is off.
- To restore the clock display, select Set Clock and PRESS.

TOUCH FIRST SCREEN pad, TURN to Custom and PRESS.

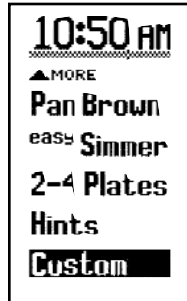

TURN to Set Clock and PRESS.

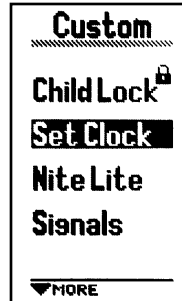

TURN to Set Hours and PRESS.

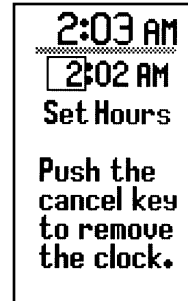

TURN to set Minutes and PRESS.

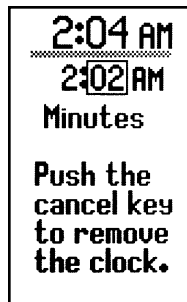

TURN to Set AM or PM and PRESS.

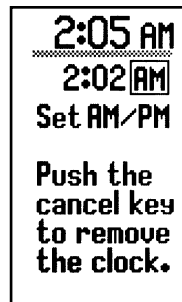

PRESS to enter the time.

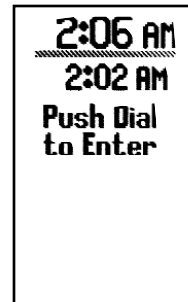

## Using the Child Lock

The Child Lock locks the control panel so children cannot use the microwave oven when you do not want them to.

### To lock the control panel:

1. TURN to select Custom  
PRESS for Next Screen.
2. PRESS to select Child Lock  
(Icon) will appear on the display screen.
3. TURN left to CLOSED.

LOCKED will appear when you touch the control or any pad except FAN ON/OFF and LIGHT ON/OFF.

### To unlock the control panel:

1. Repeat Steps 1 and 2.
2. TURN right to OPEN.

**NOTE:** The "lock" icon will appear in the top right corner of the First Screen.

TOUCH FIRST SCREEN pad, TURN to select Custom and PRESS.

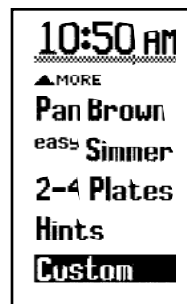

TURN to select Child Lock and PRESS.

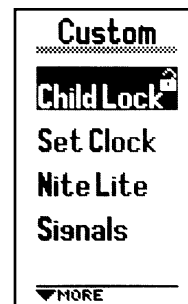

TURN to CLOSED and PRESS.

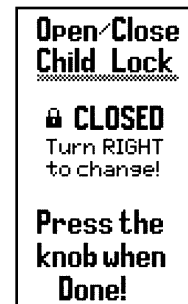

# USING YOUR MICROWAVE OVEN

## Audible signals

Your microwave oven comes with audible signals that can guide you when setting and using your oven:

A programming tone will sound each time you press the MICRO-DIAL™ control or touch a pad.

One long tone signals the end of a Minute Timer countdown.

**Four tones**  signal the end of a cooking cycle.

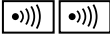
**Two quick, short tones**  sound once every minute for the first 15 minutes after an end-of-cooking signal as a reminder if the food has not been removed from the oven.

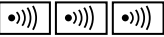
**Three tones**  sound if you have made an incorrect entry.

**To disable the programming tone:**

TOUCH FIRST SCREEN pad, TURN to select Custom and PRESS.

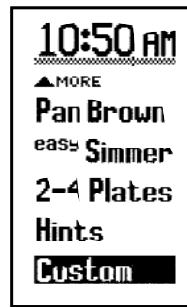

TURN to select Signals and PRESS.

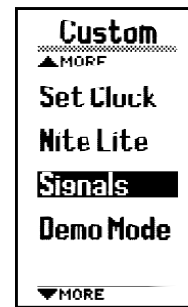

Turn dial to select function and "OFF" will be displayed.

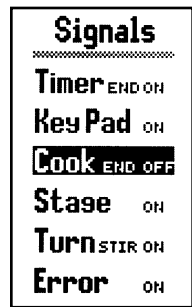

## Using Bookmark

This program lets you store and use up to 10 of your favorite functions, without having to go through the normal selection process.

**To save or add a function in Bookmark:**

1. TOUCH the FIRST SCREEN pad and PRESS.
2. TURN to select a function; TURN to select food.
3. TOUCH the BOOKMARK pad. PRESS to add selected function to Bookmark.

**To use a function in Bookmark:**

1. TOUCH the FIRST SCREEN pad.
2. TOUCH the BOOKMARK pad.
3. TURN to select a bookmarked function and PRESS.
4. Follow instructions for selected function.

**To delete a program in Bookmark:**

1. TOUCH the FIRST SCREEN pad.
2. TOUCH the BOOKMARK pad. The list of bookmarked functions is displayed.
3. TURN to bookmarked function to be deleted.
4. PRESS the BOOKMARK pad. Screen displays deletion confirmation. PRESS to delete selected bookmark function.

**NOTES:**

- All functions can be placed in Bookmark except Welcome, First Screen, Bookmark, Set Clock, Popcorn, Fan, Light, Turntable, Minute Timer, Manual and preparations screens.
- Bookmarks are stored and displayed in chronological order with the last addition at the top of the list.
- If ten bookmarks are already stored, the addition of another bookmark will automatically cause the deletion of the oldest bookmark.
- If a function already stored as a bookmark is stored again, the bookmarked function will move to the top of the list. All other bookmarks remain the same.

# USING YOUR MICROWAVE OVEN

## Using the Minute Timer

You can also use your microwave oven as a kitchen timer. Use the Minute Timer for timing up to 90 minutes.

**NOTE:** The oven can operate while the Minute Timer is in use. To see the Minute Timer while the oven is cooking, touch TIMER SET/OFF.

### To set Timer:

1. TOUCH TIMER SET/OFF.
2. TURN to Set Time and PRESS.
3. TURN to START and PRESS.

### To cancel Timer:

1. TOUCH TIMER SET/OFF.

## Understanding “Doneness” Control

For many cooking functions, the screen displays a “Doneness” bar which you control by turning the MICRO-DIAL™ control toward Plus or Minus.

For most foods, the maximum and minimum “Doneness” settings add or subtract about 6% from Normal cook time.

For Defrost, the controlled percentage depends on food type and weight.

**NOTE:** When the “Doneness” function is completed for a specific food, the “Doneness” bar stays at that setting. It does not re-set to the previous setting.

## Understanding Sensor Cooking

Food releases humidity during cooking/heating. How much humidity food releases is affected by the quantity, temperature and shape of the food. Your microwave oven has a sensor that detects this

humidity. The amount of humidity detected tells the oven how long to cook or heat your food. Just set the MICRO-DIAL control for the food you want to cook or heat.

## Using Reheat

You can reheat microwavable foods just by choosing a category and quantity. Reheat has preset times and cook powers for 9 categories, plus Manual.

1. TURN dial to select Reheat and PRESS for next screen
2. TURN to select one of 9 Reheat categories, or Manual and PRESS for next screen.

3. TURN to select “Doneness”, if desired, and PRESS. TURN to set or reset “Doneness” and PRESS.

4. TURN to select START and PRESS to activate Reheat program.

**NOTE:** If you need more or less cooking time, select and adjust “Doneness” before choosing START.

# USING YOUR MICROWAVE OVEN

## Manual Cooking at variable powers

For best results, some recipes call for different cook powers. Each percentage stands for a different level of cook power; i.e., 100% equals full power. The lower the cook power, the slower the cooking.

1. TOUCH COOK TIME pad.
2. TURN to Time and PRESS. TURN to set cook time and PRESS.
3. TURN to Power and PRESS. TURN to cook power and PRESS.
4. TURN to Start and PRESS.

Many microwave cookbook recipes tell you by number, percent or name which cook power to use. The following chart gives the percentage of cook power each number stands for, and the cook power name usually used. It also tells you when to use each cook power. Follow recipe or food package instructions if available.

**NOTE:** Refer to a reliable cookbook for cook times. The maximum power for this oven is 1000 watts.

COOK POWER	NAME	WHEN TO USE IT
100% of full power	High	<ul style="list-style-type: none"><li>• Quick heating many convenience foods and foods with high water content, such as soups, beverages and most vegetables</li></ul>
90% of full power		<ul style="list-style-type: none"><li>• Cooking small tender pieces of meat, ground meat, poultry pieces and fish fillets</li></ul>
80% of full power		<ul style="list-style-type: none"><li>• Heating cream soups</li><li>• Heating rice, pasta, or stirrable casseroles</li></ul>
70% of full power	Medium-High	<ul style="list-style-type: none"><li>• Cooking and heating foods that need a cook power lower than high (for example, whole fish and meat loaf)</li></ul>
60% of full power		<ul style="list-style-type: none"><li>• Reheating a single serving of food</li><li>• Cooking sensitive foods, such as cheese and egg dishes, pudding, and custards</li><li>• Cooking nonstirrable casseroles, such as lasagna</li></ul>
50% of full power	Medium	<ul style="list-style-type: none"><li>• Cooking ham, whole poultry, and pot roasts</li><li>• Simmering stews</li></ul>
40% of full power		<ul style="list-style-type: none"><li>• Melting chocolate</li><li>• Heating bread, rolls and pastries</li></ul>
30% of full power	Medium-Low, Defrost	<ul style="list-style-type: none"><li>• Defrosting foods, such as bread, fish, meats, poultry, and precooked foods</li></ul>
20% of full power		<ul style="list-style-type: none"><li>• Softening butter, cheese, and ice cream</li></ul>
10% of full power	Low	<ul style="list-style-type: none"><li>• Keeping food warm</li><li>• Taking chill out of fruit</li></ul>



# USING YOUR MICROWAVE OVEN

## Manual Cooking in stages

For best results, some recipes call for one cook power for a certain length of time and another cook power for another length of time. Your oven can be set to change from one to another automatically for up to 4 stages.

You can set your chosen cook functions in any order. However, if you use Defrost, it must be the *first* stage.

### To set cooking stages:

1. Put your food in the oven and close the door.
2. TOUCH COOK TIME pad.
3. Enter first-stage cooking time.

TURN to Time and PRESS.

TURN to set Time, PRESS to enter Time.

4. Set first-stage cook power.

TURN to Power and PRESS.

TURN to set Power, PRESS to enter Power.

5. Complete first-stage program.

TURN to Add Stage and PRESS to set.

6. Repeat Steps 3-5 for next stage(s).

7. Start the oven

TURN to select Start and PRESS to enter.

### Changing instructions

You can change cooking times for a stage any time after that stage starts by turning the MICRO-DIAL™ control.

## Using Defrost

You can defrost meats, poultry and fish by entering the weight. If the weight is not known, the oven will help you. You can also defrost using manual setting.

### Defrosting by weight:

1. TOUCH FIRST SCREEN pad. TURN to select Defrost and PRESS.
2. TURN to select category and PRESS.
3. TURN to select Yes and PRESS.
4. TURN to select weight and PRESS.
5. TURN to START and PRESS.

### Defrosting unknown weight:

1. TOUCH FIRST SCREEN pad. TURN to select Defrost and PRESS.
2. TURN to select category and PRESS.
3. TURN to select No. Help me and PRESS.
4. If steaks, chops, or poultry pieces are selected, TURN to select Size and PRESS.
5. TURN to enter amount and PRESS.
6. TURN to START and PRESS.

## Defrosting tips

- **When using DEFROST**, the weight to be entered is the net weight in pounds and tenths of pounds (the weight of the food minus the container).
- **Before starting**, make sure you have removed any of the metal twist-ties which often come with frozen food bags, and replace them with strings or elastic bands.
- **Open containers** such as cartons before they are placed in the oven.
- **Always slit** or pierce plastic pouches or packaging.
- **If food is foil wrapped**, remove foil and place it in a suitable container.
- **Slit** the skins, if any, of frozen food such as sausage.
- **Bend** plastic pouches of food to ensure even defrosting.
- **Always underestimate** defrosting time. If defrosted food is still icy in the center, return it to the microwave oven for more defrosting.
- **The length** of defrosting time varies according to how solidly the food is frozen.
- **The shape of the package** affects how quickly food will defrost. Shallow packages will defrost more quickly than a deep block.
- **As food begins to defrost**, separate the pieces. Separated pieces defrost more easily.
- **Use small pieces of aluminum foil** to shield parts of food such as chicken wings, leg tips, fish tails, or areas that start to get warm. Make sure the foil does not touch the sides, top, or bottom of the oven. The foil can damage the oven lining.
- **For better results**, let food stand after defrosting.
- **Turn over** food during defrosting or standing time. Break apart and remove food as required.

# USING YOUR MICROWAVE OVEN

## Weight conversion chart

DECIMAL WEIGHT	EQUIVALENT OUNCE WEIGHT	EQUIVALENT GRAM WEIGHT
.10	1.6	45
.20	3.2	91
.25 One-Quarter Pound	4.0	113
.30	4.8	136
.40	6.4	181
.50 One-Half Pound	8.0	227
.60	9.6	272
.70	11.2	318
.75 Three-Quarters Pound	12.0	340
.80	12.8	363
.90	14.4	408
1.00 One Pound	16.0	454

## Using Pan Brown

Pan Brown uses the Crisper pan to brown, crisp and pan-fry foods in the microwave oven.

While microwaves heat the food from above, they also heat the browning pan very quickly from below to brown and crisp the food.

If using the Crisper pan for a Manual Cooking function; for best results, pre-heat empty pan in the microwave oven for 3 minutes.

With just a few simple touches of the MICRO-DIAL™ control, you can make crispy pizza, sizzle chicken, fry eggs, or cook juicy hamburgers.

1. TOUCH FIRST SCREEN pad, TURN to Pan Brown and PRESS.
2. TURN to select category and PRESS.
3. Follow directions on display.

### Using the pan

- Do not use plastic utensils on the pan. The pan becomes very hot quickly and could melt the utensils.
- Do not use any metal utensils as they can scratch the pan.
- Do not use the pan in any other microwave oven or in a thermal oven.
- Always use the turntable as support for the pan.
- For best results when cooking with the pan, preheat for 3 minutes on High before using it. Coat pan lightly with cooking oil to make removing food and cleaning easier.

### Cleaning the pan

Wash pan in dishwasher or in mild, soapy water. Avoid using abrasive cleansers or scrubbers.

# USING YOUR MICROWAVE OVEN

## Using aluminum foil

Metal containers should not be used in a microwave oven. There are, however, some exceptions. If you have purchased food which is prepackaged in an aluminum foil container, refer to the instructions on the package. When using aluminum foil containers, cooking times may be longer because microwaves will only penetrate the top of the food.

If you use aluminum containers without package instructions, follow these guidelines:

- **Place** the container in a glass bowl and add some water so that it covers the bottom of the container, not more than  $\frac{1}{4}$  in. (6.35 mm) high. This ensures even heating of the container bottom.
- **Always remove** the lid to avoid damage to the oven.
- **Use only** undamaged containers.
- **Do not use** containers taller than  $\frac{3}{4}$  in. (19 mm).
- **Container must be** at least half filled.
- **To avoid arcing**, there must be a minimum  $\frac{1}{4}$  in. (6.35 mm) between the aluminum container and the walls of the oven and also between two aluminum containers.
- **Always place** the container on the turntable.
- **Reheating food** in aluminum foil containers usually takes up to double the time compared to reheating in plastic, glass, china, or paper containers. The time when food is ready will vary depending upon the type of container you use.
- **Let food stand** for 2 to 3 minutes after heating so that heat is spread evenly throughout container.

## Cooking you should not do in your microwave oven

- **Do not** do canning of foods in the oven. Closed glass jars may explode, resulting in damage to the oven.
- **Do not** use the microwave oven to sterilize objects (baby bottles, etc.). It is difficult to keep the oven at the high temperature needed for sterilization.

## Using EASY SIMMER

Use EASY SIMMER to prepare food such as rice, pasta, soups, and vegetables. All you do is set a EASY SIMMER time and your oven will bring your food to a boil and then simmer it for the time you specify.

### NOTES:

- This function uses a sensor, which needs  $2\frac{1}{2}$  minutes to warm up after the oven is first connected or after a power failure. If you start EASY SIMMER during the warm-up, microwave energy will not be turned on until the sensor is warm.
  - When cooking vegetables, use a minimum of  $\frac{1}{2}$  cup (125 mL) of water.
  - For best results, cover dish with a lid that comes with the dish or a dinner plate.
1. Place the food in the oven and shut the door.
  2. TOUCH FIRST SCREEN pad, TURN to EASY SIMMER and PRESS.
  3. TURN to select category  
PRESS for Next Screen.
  4. TURN to select food or Boil & Simmer.  
PRESS for Next Screen.
  5. FOLLOW instructions.  
PRESS to Start.

# USING YOUR MICROWAVE OVEN

## Using 2-4 Plates

When heating food with a cook time that you set, you can heat two 10¼ in.

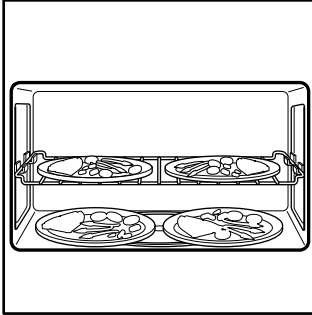

(26.7 cm) plates side by side or one dish larger than the turntable, plus two plates on the cooking rack. For best results, halfway through cooking turn the plates halfway around. Do the same when heating a larger (9 to 13 in. [23 to 33 cm]) casserole. When heating 4 dinner plates, switch the plates between top and bottom when you turn them.

(26.7 cm) plates side by side or one dish larger than the turntable, plus two plates on the cooking rack. For best results, halfway through cooking turn the plates halfway around. Do the same when heating a larger (9 to 13 in. [23 to 33 cm]) casserole. When heating 4 dinner plates, switch the plates between top and bottom when you turn them.

To heat 2 bottom plates together or one larger dish, the turntable should not be turning.

**TURNTABLE  
ON•OFF**

You can shut the turntable off by touching TURNTABLE ON/OFF.

"TURNTABLE OFF" appears on the display. PRESS to enter setting.

1. TOUCH FIRST SCREEN pad, TURN to 2-4 Plates and PRESS.
2. TURN to select number of plates and PRESS.
3. Arrange plates as shown on left. PRESS to Start.

**NOTE:** You cannot choose Turntable Off during auto cook functions.

## Using the Exhaust Fan

1. Turn on the fan and choose fan speed from 0% to 100%.

TOUCH FAN ON/OFF



To increase fan speed, TOUCH the Upper arrow.  
To decrease fan speed, TOUCH the Lower arrow.

The display screen will show "FAN" and the percentage of the fan speed.

**NOTE:** If temperature from the range or cooktop below the oven gets too hot, the exhaust fan in the vent hood will automatically turn on at the "100%" setting to protect the oven. It may stay on up to an hour to cool the oven. When this occurs, the FAN ON/OFF pad will not turn off the fan.

### NOTES:

- Two seconds after the last time you touch FAN ON/OFF, the screen returns to the previous display.
- The first time you turn on the fan after connecting the microwave oven to power, the fan will start at speed two. The next time the fan is turned on, it will start at the last speed used.

2. Turn off fan when desired.

TOUCH FAN ON/OFF

# USING YOUR MICROWAVE OVEN

## Using the Cooktop Light

1. Turn on light and choose the brightness from 0 to 100%.

TOUCH LIGHT ON/OFF



To increase cooktop brightness, TOUCH the Upper arrow.

To decrease cooktop brightness, TOUCH the Lower arrow.

2. Turn off light when desired.

TOUCH LIGHT ON/OFF

### Using the Sensor Nite Lite

1. TURN to select Custom. PRESS for next screen.
2. TURN to select Nite Lite. PRESS for next screen.
3. TURN to Set Level and PRESS.
4. TURN the Nite Lite monitor from 0% to 100%.

Current room light level



Set activation level

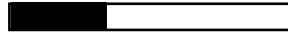

To increase activation level turn the MICRO-DIAL™ control forward to desired level and PRESS.

**NOTE:** The current room light level will fluctuate based upon current light conditions.

## Using the cooking rack

The cooking rack gives you extra space when cooking in more than one container at the same time.

### Inserting the rack

Insert the rack securely into the rack supports on the side walls of the oven.

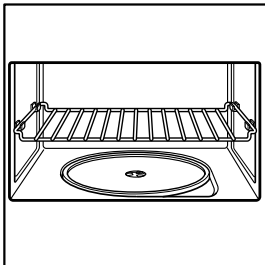

### NOTES:

- Only use the cooking rack when cooking at more than one level.
- Use rack only in the microwave oven.
- Do not let food container on rack touch the top or sides of the oven.
- Do not use rack with browning dish.
- Do not place a metal cooking container on rack.
- Do not store the metal rack in the oven. Do not operate the oven with the metal rack stored on the floor of the oven. Damage to the interior finish will result.
- Use oven mitts to remove items from microwave oven.
- Do not cook foods directly on rack. Put them in microwave-safe containers first.

# CARING FOR YOUR MICROWAVE OVEN

## Installing and caring for the filters

The grease filters should be removed and cleaned often, at least once a month.

**NOTE:** Your microwave hood combination comes with a charcoal filter to provide clean recirculated air. **The charcoal filter cannot be cleaned and should be replaced every 6 to 12 months.**

You can order replacements (PN 4393690) by calling **1-800-422-1230** and following the instructions and telephone prompts you hear.

If you prefer, you can visit our website at: **www.kitchenaid.com**

### ! WARNING



#### Electrical Shock Hazard

**Disconnect power before removing filters.**  
**Replace all panels before operating.**  
**Failure to do so can result in death or electrical shock.**

### Removing, cleaning, and replacing

1. Unplug microwave oven or disconnect power.

2. To remove the grease filters (PN 4393691),

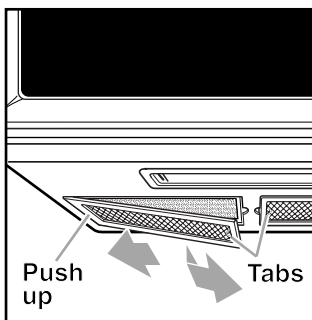

push each filter up on the side opposite the tab. Grasp the tab and slide the filter to the side. Pull the filter downward. It will drop out.

3. To remove the charcoal filters, push the back of each filter away from you. This will slide the front of the filter off the lower lip. Swing the front of the filter down and slide the filter out.

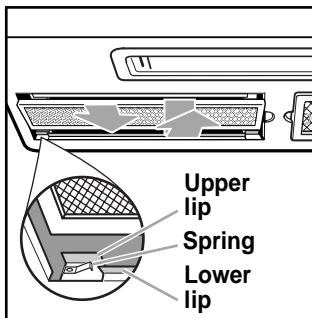

4. Soak grease filters in hot water and a mild detergent. Scrub and swish to remove embedded dirt and grease. Rinse well and shake to dry.

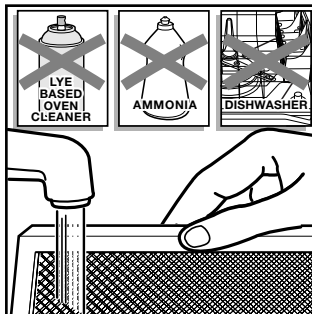

**Do not use ammonia, corrosive cleaning agents such as lye-based oven cleaners, or place in a dishwasher. The filter will turn black or could be damaged.**

5. To replace the charcoal filters, push each filter

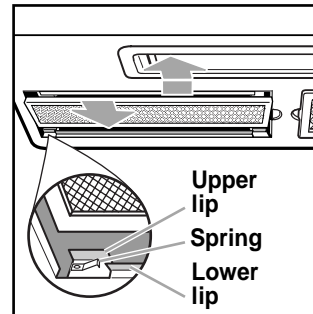

to the back of the opening, between the upper and lower lips against the springs. Swing the front of the filter up against the upper lip. Slide the filter forward while pushing it up against the upper lip. The filter will now be held in position between the lips by the spring.

6. To replace the grease filters, slide each filter into the outer side of the filter opening. Make sure you are sliding in the side of the filter that does not have the tab. Hold the tab with your other hand. Push up the tab side of the filter and slide the filter to the other side of the opening to lock into place.

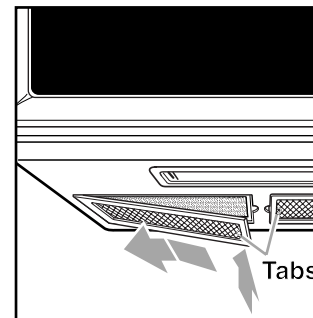

7. Plug in microwave oven or reconnect power.

**NOTE:** Do *not* operate the vent fan without the grease filters in place.

# CARING FOR YOUR MICROWAVE OVEN

## Replacing the cooktop and oven lights

### The cooktop light

1. Unplug microwave oven or disconnect power.
2. Remove the bulb cover mounting screw and carefully remove the cover.

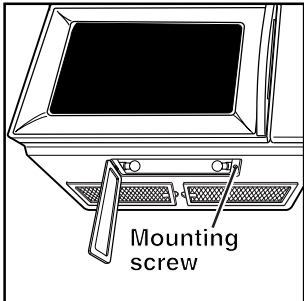

3. Remove the burnt-out bulb(s) and replace with 10W low-voltage halogen capsule bulb(s) (PN 8169418).\* Use a soft tissue to handle bulb(s), or wear a cotton glove. Do not touch bulb(s) with your bare fingers.
4. Replace the bulb cover and mounting screw.
5. Plug in microwave oven or reconnect power.

### The oven light

1. Unplug microwave oven or disconnect power.
2. Remove the two vent grille mounting screws located above the cover (the two outer screws).

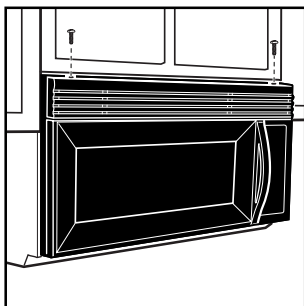

3. Tip the grille forward, then lift out to remove.

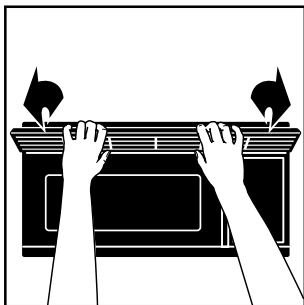

4. Lift up the bulb cover.

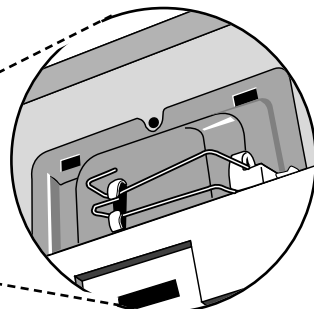
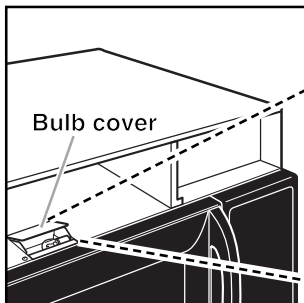

5. Remove the burnt-out bulb by squeezing the wire clip together, pulling to the right and lifting up. Replace the bulb with a 10W low-voltage halogen capsule bulb (PN 8169418).\* Use a soft tissue to handle the lamp, or wear a cotton glove. Do not touch lamp with your bare fingers.

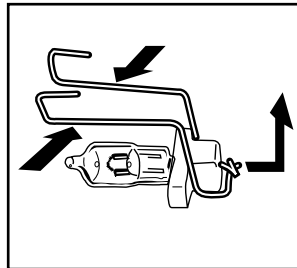

6. Close the bulb cover.
7. Slide the top of the vent grille into place. Push the bottom until it snaps into place. Replace the mounting screws.

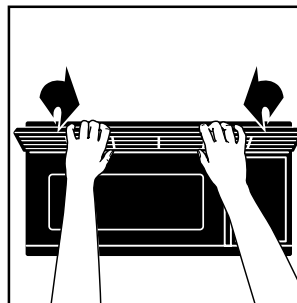

8. Plug in microwave oven or reconnect power.

\* To order bulbs call **1-800-422-1230** and follow the instructions and telephone prompts you hear.

If you prefer, you can visit our website at:  
**[www.kitchenaid.com](http://www.kitchenaid.com)**

# QUESTIONS AND ANSWERS

QUESTIONS	ANSWERS
Can I operate my microwave oven without the turntable or turn the turntable over to hold a large dish?	You can turn off the turntable to heat 2 dinner plates side by side or one dish that's larger than the turntable. However, if you only need to heat one plate on the turntable, keep the turntable on for best cooking results. Also, you should not turn over the turntable. A plate used on the turntable must fit on it when the turntable is correct side up.
Can I use a rack in my microwave oven so that I may reheat or cook on two levels at a time?	You can use a rack only if the rack is supplied with your microwave oven. If you use a rack not supplied with the microwave oven, you can get poor cooking performance and/or arcing.
Can I use either metal or aluminum pans in my microwave oven?	You can use aluminum foil for shielding (use small, flat pieces), small skewers, and shallow foil trays (if tray is $\frac{3}{4}$ in. [19 mm] deep or less and half filled with food to absorb microwave energy). Never allow metal to touch walls or door.
Is it normal for the turntable to turn in either direction?	Yes. The turntable rotates clockwise or counter-clockwise, depending on the rotation of the motor when the cooking cycle begins.
Sometimes the door of my microwave oven appears wavy. Is this normal?	This appearance is normal and does not affect the operation of your oven.
What are the humming noises that I hear when my microwave oven is operating?	You hear the sound of the transformer when the magnetron tube cycles on.
Why does the dish become hot when I microwave food in it? I thought that this should not happen.	As the food becomes hot it will conduct the heat to the dish. Be prepared to use hot pads to remove food after cooking.
Why does steam come out of the air exhaust vent?	Steam is normally produced during cooking. The microwave oven has been designed to vent this steam out the vent.



# TROUBLESHOOTING

Most cooking problems often are caused by little things you can find and fix without tools of any kind. Check the lists below and on the next page before calling for assistance or service. If you still need help, see the "Requesting Assistance or Service" section.

## Microwave oven does not work

PROBLEM	CAUSE
Nothing works.	<ul style="list-style-type: none"><li>• The power supply cord is not plugged into a live circuit with the proper voltage. (See the "Electrical requirements" section on page 5 and the "Electrical connection" section on page 7.)</li><li>• A household fuse has blown or a circuit breaker has tripped.</li><li>• The electric company has had a power failure.</li></ul>
The microwave oven will not run.	<ul style="list-style-type: none"><li>• You are using the oven as a timer. Touch OFF/CANCEL to cancel the Minute Timer.</li><li>• The door is not firmly closed and latched.</li><li>• You did not press to start at the end of a function.</li><li>• You did not follow directions exactly.</li><li>• An operation that you set earlier is still running. Touch OFF/CANCEL to cancel that operation.</li></ul>

## Cooking times

PROBLEM	CAUSE
Food is not cooked enough.	<ul style="list-style-type: none"><li>• The electric supply to your home or wall outlets is low or lower than normal. Your electric company can tell you if the line voltage is low. Your electrician or service technician can tell you if the outlet voltage is low.</li><li>• The cook power is not at the recommended setting. Check the chart on page 16.</li><li>• You have not allowed enough cooking time for the amount of food being cooked. Larger amounts of food need longer cooking times.</li></ul>
The display shows a time counting down but the oven is not cooking.	<ul style="list-style-type: none"><li>• The oven door is not closed completely.</li><li>• You have set the controls as a Minute Timer. Touch TIMER or OFF/CANCEL to cancel the Minute Timer.</li></ul>

## Turntable

PROBLEM	CAUSE
The turntable will not turn.	<ul style="list-style-type: none"><li>• You have turned off the turntable. (See the “Using 2-4 Plates” section on page 20.)</li><li>• The turntable is not correctly in place. It should be correct-side up and sitting firmly on the center shaft.</li><li>• The support is not operating correctly. Remove the turntable and restart the oven. If the support still does not move, call a designated service technician for repair. Cooking without the turntable can give you poor results.</li></ul>

## Tones

PROBLEM	CAUSE
You do not hear the programming or end-of-cycle tone.	<ul style="list-style-type: none"><li>• You have turned off the tone. (See the “Audible signals” section on page 14.)</li></ul>

## Display contrast

PROBLEM	CAUSE
The display is hard to read.	<ul style="list-style-type: none"><li>• The display contrast is not set correctly. To adjust display contrast: TURN to select Custom. PRESS for next screen. TURN to select Display Contrast, PRESS and follow directions.</li></ul>

## Display messages

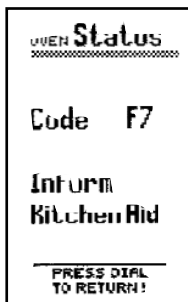

If the oven detects an internal problem, it will run a self-checking program and a screen similar to the one shown here will appear. If this occurs, please call KitchenAid at **1-800-422-1230** for assistance.

If none of these items are causing your problem, see the “Requesting Assistance or Service” section.

# REQUESTING ASSISTANCE OR SERVICE

To avoid unnecessary service calls, please check the "Troubleshooting" section. It may save you the cost of a service call. If you still need help, follow the instructions below.

## If you need assistance or service

### Call the KitchenAid Customer Interaction Center



toll free at  
**1-800-422-1230.**

When calling:

Please provide KitchenAid with the purchase date, and the complete model and serial number of your appliance (see above). This information will help us better respond to your request.

#### Our consultants provide assistance with:

- Features and specifications on our full line of appliances
- Installation information

- Use and maintenance procedures
- Accessory and repair parts sales
- Specialized customer assistance (Spanish speaking, hearing impaired, limited vision, etc.)
- Referrals to local dealers, service companies, and repair parts distributors

**KitchenAid designated service technicians** are trained to fulfill the product warranty and provide after-warranty service anywhere in the United States.

To locate the KitchenAid designated service company in your area, you can also look in your telephone directory Yellow Pages.

## For further assistance

If you need further assistance, you can write to KitchenAid with any questions or concerns at:

KitchenAid Brand Home Appliances  
Customer Interaction Center  
c/o Correspondence Dept.  
MD 8020

553 Benson Road  
Benton Harbor, MI 49022-2400

Please include a daytime phone number in your correspondence.

If you prefer, you can call the Customer Interaction Center at:

**1-800-422-1230**

or, visit our website at:

**[www.kitchenaid.com](http://www.kitchenaid.com)**

# MICROWAVE HOOD WARRANTY

<b>LENGTH OF WARRANTY:</b>	<b>KITCHENAID WILL PAY FOR:</b>
<b>ONE-YEAR FULL WARRANTY FROM DATE OF PURCHASE</b>	Replacement parts and repair labor costs to correct defects in materials or workmanship. Service must be provided by a KitchenAid designated servicing company.
<b>SECOND-THROUGH FIFTH-YEAR LIMITED WARRANTY FROM DATE OF PURCHASE</b>	Replacement of microwave magnetron tube on microwave oven to correct defects in materials or workmanship.
<b>KITCHENAID WILL NOT PAY FOR:</b>	
<p><b>A.</b> Service calls to:</p> <ol style="list-style-type: none"> <li>1. Correct the installation of the oven.</li> <li>2. Instruct you how to use the oven.</li> <li>3. Replace house fuses or correct house wiring.</li> <li>4. Service to replace customer-accessible light bulbs and filters.</li> </ol> <p><b>B.</b> Repairs when oven is used in other than normal, single-family home use.</p> <p><b>C.</b> Damage resulting from accident, alteration, misuse, abuse, fire, flood, acts of God, improper installation, or installation not in accordance with local electrical codes, or use of products not approved by KitchenAid.</p> <p><b>D.</b> Replacement of disposable charcoal filter and browning pan that require replacement due to normal use.</p> <p><b>E.</b> Any labor costs during the limited warranty.</p> <p><b>F.</b> Pickup and delivery. This product is designed to be repaired in the home.</p> <p><b>G.</b> Repairs to parts or systems resulting from unauthorized modifications made to the appliance.</p> <p><b>H.</b> Replacement parts or repair labor costs for units operated outside the United States.</p>	

7/00

**KITCHENAID DOES NOT ASSUME ANY RESPONSIBILITY FOR INCIDENTAL OR CONSEQUENTIAL DAMAGES.**

Some states do not allow the exclusion or limitation of incidental or consequential damages, so this exclusion or limitation may not apply to you. This warranty gives you specific legal rights and you may also have other rights which may vary from state to state.

**Outside the 50 United States, this warranty does not apply. Contact your authorized KitchenAid dealer to determine if another warranty applies.**

If you need service, first see the "Troubleshooting" section of this book. After checking "Troubleshooting," additional help can be found by checking the "Requesting Assistance or Service" section or by calling our Customer Interaction Center telephone number, **1-800-422-1230**, from anywhere in the United States.

## Free Manuals Download Website

<http://myh66.com>

<http://usermanuals.us>

<http://www.somanuals.com>

<http://www.4manuals.cc>

<http://www.manual-lib.com>

<http://www.404manual.com>

<http://www.luxmanual.com>

<http://aubethermostatmanual.com>

Golf course search by state

<http://golfingnear.com>

Email search by domain

<http://emailbydomain.com>

Auto manuals search

<http://auto.somanuals.com>

TV manuals search

<http://tv.somanuals.com>